



ADVANCED MIRROR TECHNOLOGY DEMONSTRATION (AMTD) PHASE 2: STATUS OF ULE[®] MIRROR

GARY MATTHEWS

Director, Universe Exploration, Space and Intelligence Solutions

H. PHILIP STAHL

NASA, AMTD PI

HARRIS[®] TECHNOLOGY TO CONNECT,
INFORM AND PROTECT[™]

HARRIS.COM | [#HARRISCORP](https://twitter.com/HARRISCORP)



AMTD Overview

- Motivation for developing technology
- 4-m Class Blank High Level Manufacturing Flow
- Mirror Design Description
- Detailed AMTD Manufacturing Flow

AMTD Phase 2 Mirror Status

- Observations
- Successes
- Lessons Learned

Future Technology Development Options and Considerations

AMTD is funded by NASA's Strategic Astrophysics Technology (SAT) Program

- Dr. H. Philip Stahl is Principal Investigator
- *“The AMTD project is in Phase 2 of a multiyear effort initiated in Fiscal Year (FY) 2012, to mature toward the next Technology Readiness Level (TRL) critical technologies required to enable 4-m-or-larger monolithic or segmented ultraviolet, optical, and infrared (UVOIR) space telescope primary-mirror assemblies for general astrophysics and ultra-high-contrast observations of exoplanets”* - excerpt from Cosmic Origins Annual Technology Report, October 2016

Harris' contribution to the AMTD project has been the development and demonstration of a new ULE[®] glass mirror technology

- During phase 1, Harris demonstrated the mirror construction at a small scale
- During phase 2, Harris has designed and is in the process of finishing a 1.5m-diameter mirror that is a 1/3 scale model of a 4-m mirror design
 - The 1.5m diameter design was developed to demonstrate lateral scalability of the new mirror blank manufacturing process technology

Existing technologies to manufacture a 4-m class monolithic mirror out of Corning ULE[®] are costly and time consuming and some would require development to be scaled up from HST 2.5m class

- Costs come from need to stack seal ULE[®] boules to get required core depth of ~0.4-0.5m
 - Existing state-of-the-art Abrasive Waterjet (AWJ) Technology can cut through ~0.45m of glass, but the core ribs have an hour glass shape that adds uncertainty into mirror finishing and mirror performance
- Corning's Frit technology process for bonding facesheets onto a lightweight core have stringent time constraints that are likely not feasible for mirrors in the 4-m class
 - Frit is also known to grow irreversibly when exposed to humidity found in mirror processing facilities
 - This growth causes quilting of the optical surface that would be unacceptable for a UVOIR type mission with coronagraphy
 - It should be noted that for most applications, the effect of frit growth can be easily accommodated in wavefront error budgets

The mirror blank manufacturing technology that has been demonstrated during AMTD significantly reduces the cost and schedule associated with fabricating a large monolith ULE[®] mirror

- The manufacturing process builds upon Harris' proprietary Low Temperature Fusion (LTF) and Low Temperature Slumping (LTS) Technologies
 - The WFIRST PM and Proprietary Programs
 - Up to 2.5m class (HST) mirrors fabricated using LTF only with a segmented core
 - More costly than LTF/LTS because curved parts must be finished to tight tolerances
 - The segmented core (multiple piece) core reduces core processing risk
 - Advanced Mirror System Demonstrator (AMSD) and Multiple Mirror System Demonstrator (MMSD) programs utilized LTF/LTS blanks with a segment core
 - Geometries comparable to JWST Primary Mirror Segments for segmented systems
 - Technology is fully qualified to TRL 6

The AMTD manufacturing process uses the LTF/LTS approach with the added feature of using a segmented stacked core to achieve deeper depths

- At the 4-m class, standard ULE[®] boules, ~Ø1.5m x ~0.15m thick easily shined as plano parts and then lightweighted using COTS AWJ machines
 - Eliminates cost and schedule of stack sealing boules
 - Eliminates need for shining curved parts
 - Allows for additional tailoring of core design to minimize mass
 - Maintains required strength and stiffness

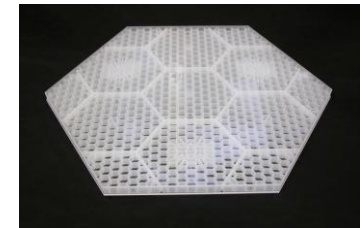

MMSD Mirror Blank

4m-class Segmented Stacked Core LTF/LTS Blank Manufacturing Flow



4m concept utilizes 3 full depth boules

- 36 standard boules required for core
- If deeper core is required would need 48 boules for concept shown

4m Plate Flow

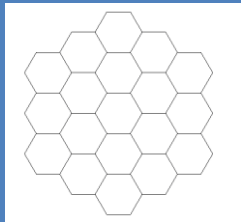

Edge Seal Plate Hexes

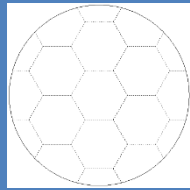

Round Plate Solid

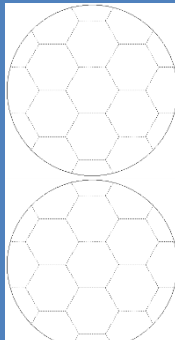

Wire Saw Plate

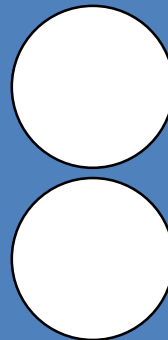

Shine Plates for LTF

4m Core Flow

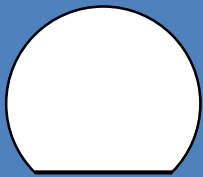

LTF Shine Standard ULE® Boules

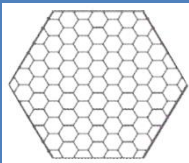

AWJ Core Boules

LTF
LTS
Conventional Finishing

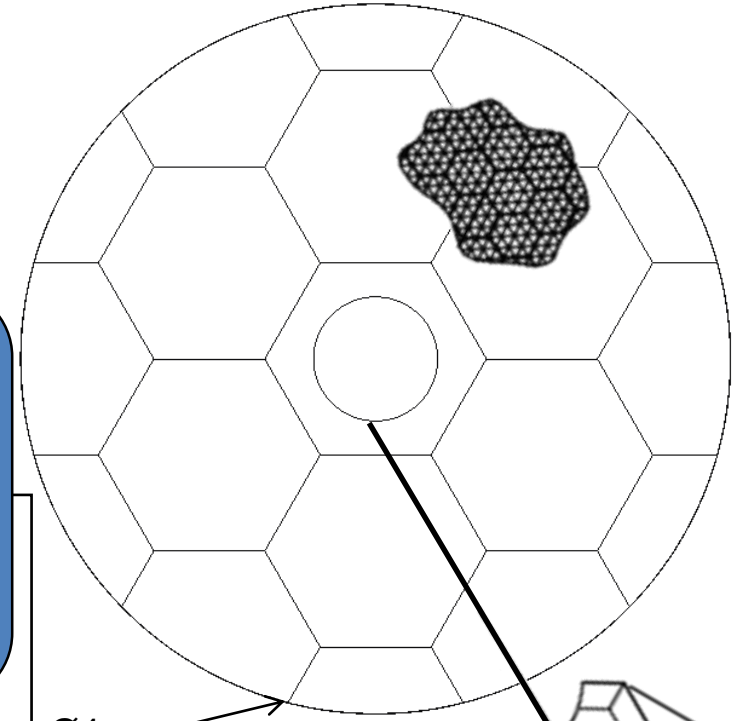

Ø4m

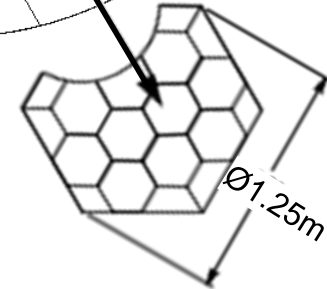

Ø1.25m

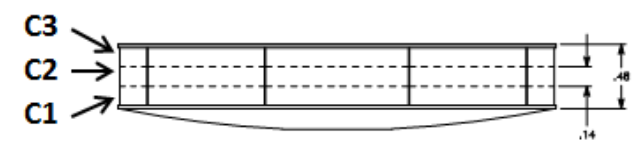

Construction:

- ~1.5m Ø Segmented Stacked Core
- LTF/LTS
- 18, 56mm tall core segments, 6 petals stacked 3 high
- Core rib thickness varies 0.5mm from 1 layer to next
 - Enables alignment of core segments within a stack
- LTF performed with plates at ~10mm thickness
- LTS performed with back plate shined at finished thickness of ~6.5mm

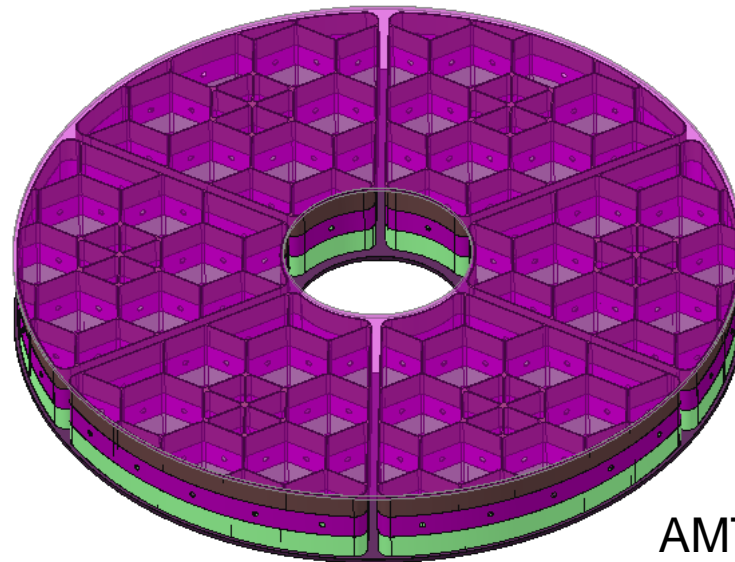

AMTD 1.5m Plano Blank

Mirror Processing: Plate & Core Flow

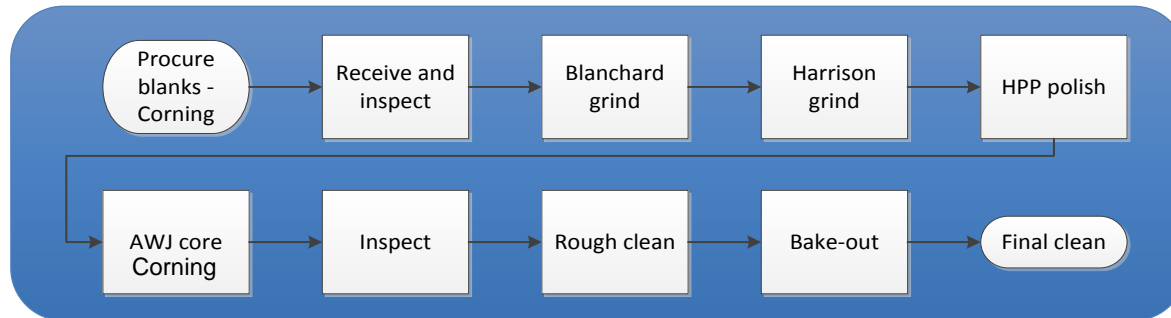
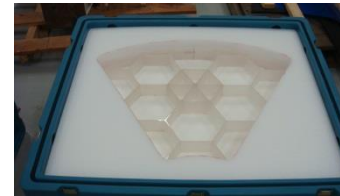
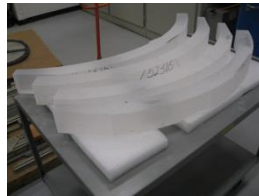
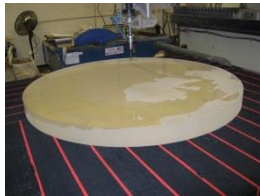
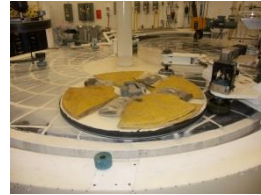

Conventional Grind and Shine of Plano Parts to Prepare for LTF of Mirror Blank

Mirror Processing Flow: LTF, LTS thru Ion

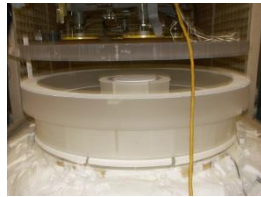
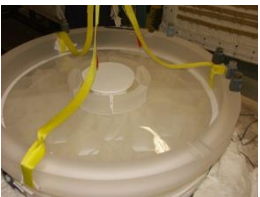
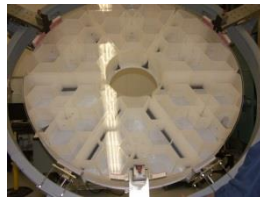
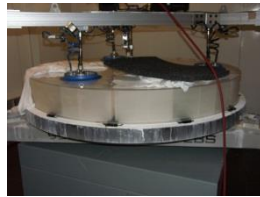
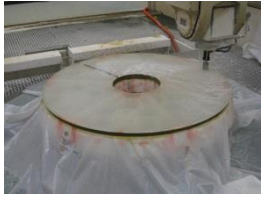
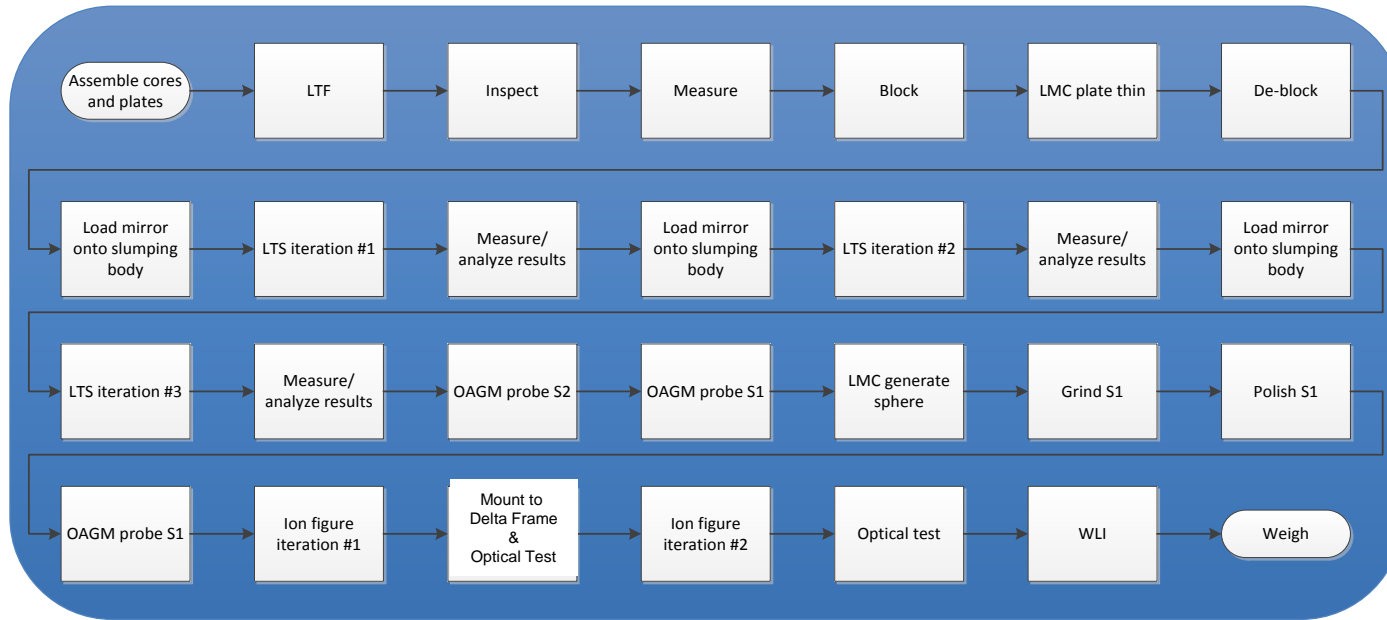

Flow is Analogous to AMSD/MMSD Segments But with Segmented Stacked Core

Mirror Blank has been fused and slumped

- Core rib geometry has more bowing than was expected from visco-elastic Finite Element Model (FEM) simulations, but blank is still viable for AMTD and mirror finishing is proceeding per plan

Spherical surface (R~3.5m) has been generated in front surface

Mirror planned to be completed with conventional grind and polish and ready for initial ion figuring run mid-December



Observations

- Mirror core ribs bowed more than predicted by visco-elastic simulation model and not in consistent directions from 1 core stack to the next
 - Identified two primary root causes
 - Assumption that cores were fused at the beginning of the LTF furnace cycle in FEM simulation
 - It should be noted that LTF simulations of AMSD/MMSD & WFIRST mirror blanks had excellent correlation – these mirrors did not have “stacked core”
 - Imperfect core alignment was not simulated
 - Core geometry can be biased (non-vertical walls) to cause rib bowing to occur in a more deterministic manner
- Core bowing magnitude changed after Low Temperature Slumping
 - Changes consistent with post-LTF geometry

Successes

- LTS FEM simulations did good job at predicting global deformation of mirror blank
 - No attempts have been made on past mirrors to correlate LTS simulation parameters
 - Not required because degree of slumping on AMSD/MMSD mirrors was small

Core alignment within a stack is critical

- May be less critical with biasing geometry

Resulting geometry from LTF/LTS process for this aspect ratio of mirror is likely not sufficiently deterministic to enable vertical testing of the optic

- Vertical testing requires a highly accurate FEM to simulate test conditions
- May be able to use multi-point support as was done on HST PM
- Can utilize multi-orientation horizontal testing, as planned for AMTD

Segmented Core approach with LTF is a viable technology moving forward

- Additional work is needed to understand geometry changes from LTF at core-core faying surfaces

Scaling Segmented Stacked Core/LTF/LTS process to 4m-class mirrors has challenges

- With additional development and utilizing some other Harris Technologies, a LTF/segmented stacked core (no LTS) may be preferable

LTF/LTS Simulation Maturation

- Develop techniques for more deterministically analyzing behavior of LTF process for stacked core mirrors
- Improve accuracy of models for simulating LTS process

LTF Bond Inspection

- Development required to inspect stacked core mirrors to verify integrity of LTF bonds at core-to-core faying surfaces
 - Currently core-to-faceplate LTF bonds can easily be inspected visually by looking through faceplates

Capture Range Replication

- A process where plano faceplates have an optical finish and are replicated over a precision mandrel such that the resulting surface does not require any grinding
 - Surface is within capture range of deterministic finishing processes such as ION or MRF
 - May require some smoothing, but NO grinding
 - CRR can be used on faceplates as components or with mirror blanks
- Initial CRR technology has been developed by Harris on IR&D

Fire Polishing

- An approach to shine/polish a plate versus conventional grind and shine
- If successful, approach would be faster and less costly
- Requires development
 - Verification of material properties
 - Verification that fire polished surfaces can be LTF's

Potential Alternative Manufacturing Flow for a 4-m class mirror drawing from AMTD Lessons Learned

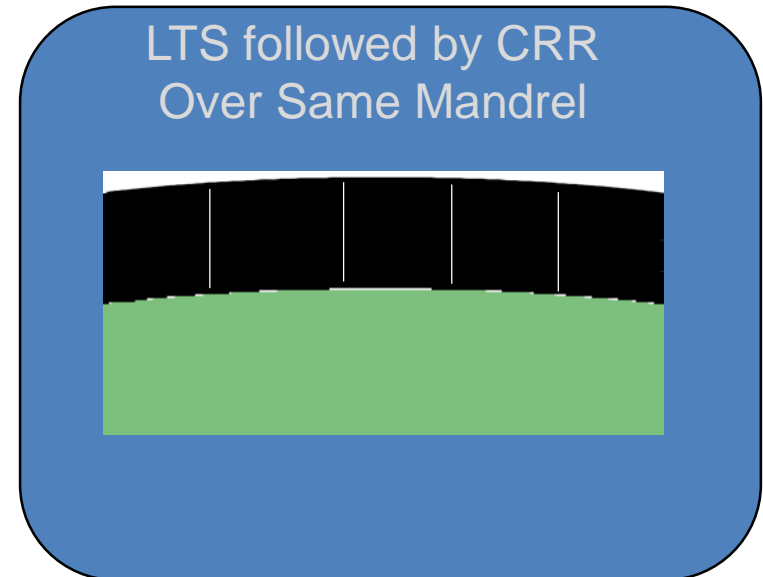
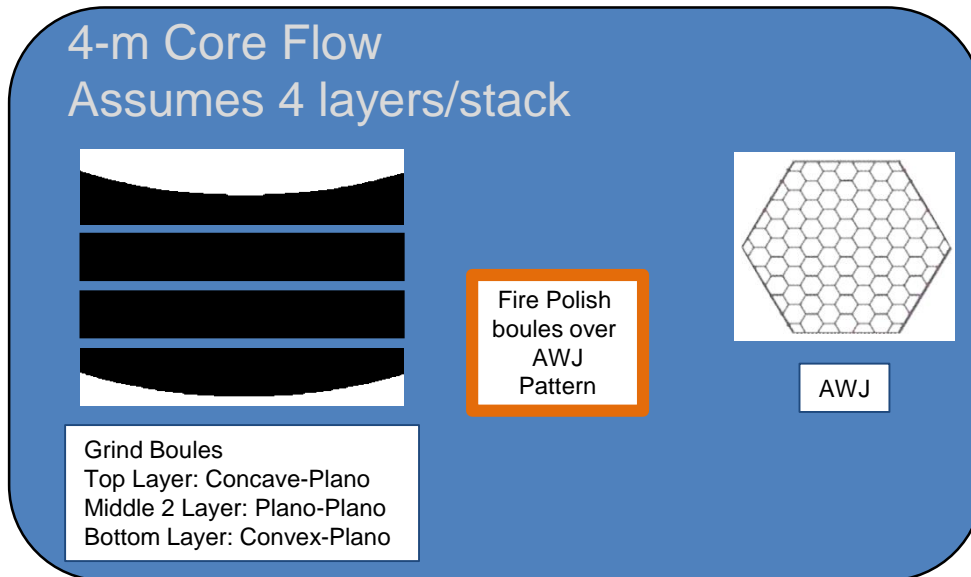
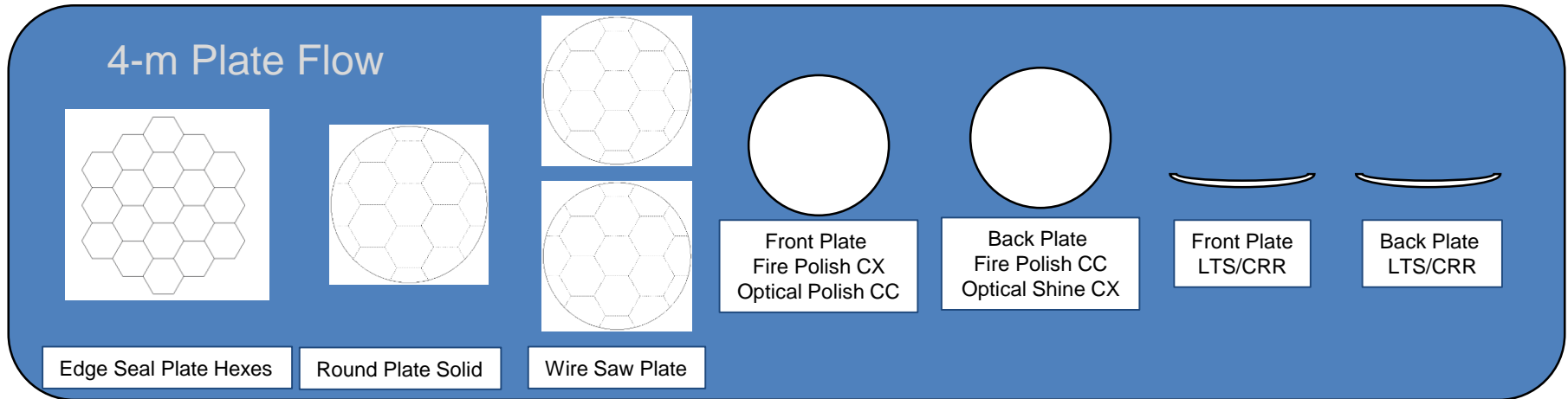

Proposed Alternate Manufacturing Process Should Yield Mirror With Deterministic Geometry