

Status, Development Plan & Challenges Ahead for the XRS Optics



Lester M. Cohen/SAO
XRS Project Office
Chief Telescope Engineer
Nov. 2016, Tech Days

Disclaimer

Please note that all of the information in this presentation has not yet been approved (or necessarily will be approved) by the XRS STDT. The information in this presentation has been extracted from various sources that have been published over the past year or so. As the STDT more clearly defines what science wants/needs, this and other presentations will be updated.

Topics to Be Covered Today

- What is XRS
- What does a grazing incidence X-ray telescope look like
 - Chandra
 - XMM
 - Other
- Hypothetical XRS Telescope Parameters
- Hypothetical Error budget
- Current methodologies for manufacturing thin shell segmented & full shell optics
 - Processes
 - Materials
 - Post manufacture figure improvements
 - Post launch figure correction
 - State of the state
 - Effects of coatings
- Assembly & alignment requirements
- Industrial opportunities
- Conclusion

What is the X-Ray Surveyor Mission?

Similar to Chandra, X-Ray Surveyor will observe X-ray sources throughout the cosmos and help scientists learn about the processes that govern stellar and cosmic evolution.

Mission Description

Launch	2030 +
Orbit	Sun-Earth L2 or other Lagrange point
Duration	5 years (20 years consumables)

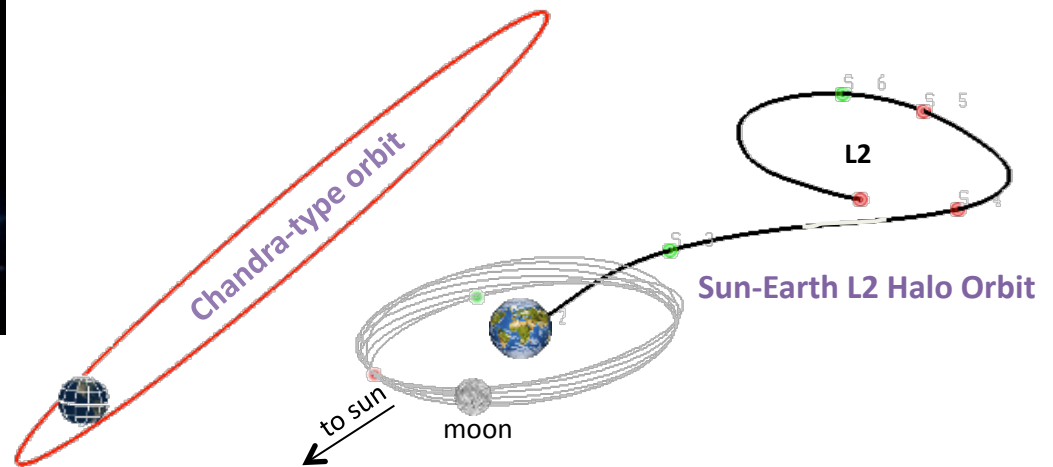
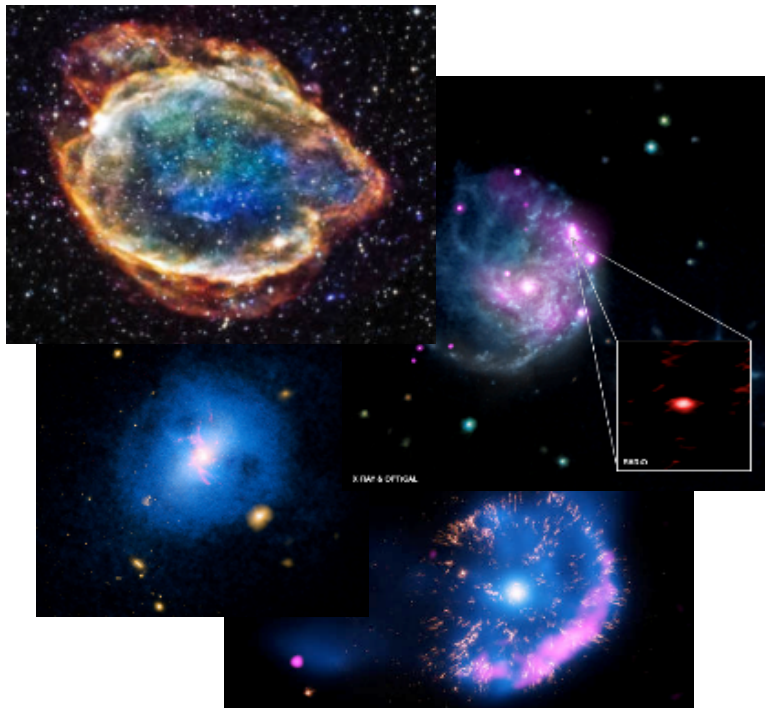

A Classical Wolter 1 Telescope (As Used for Chandra)

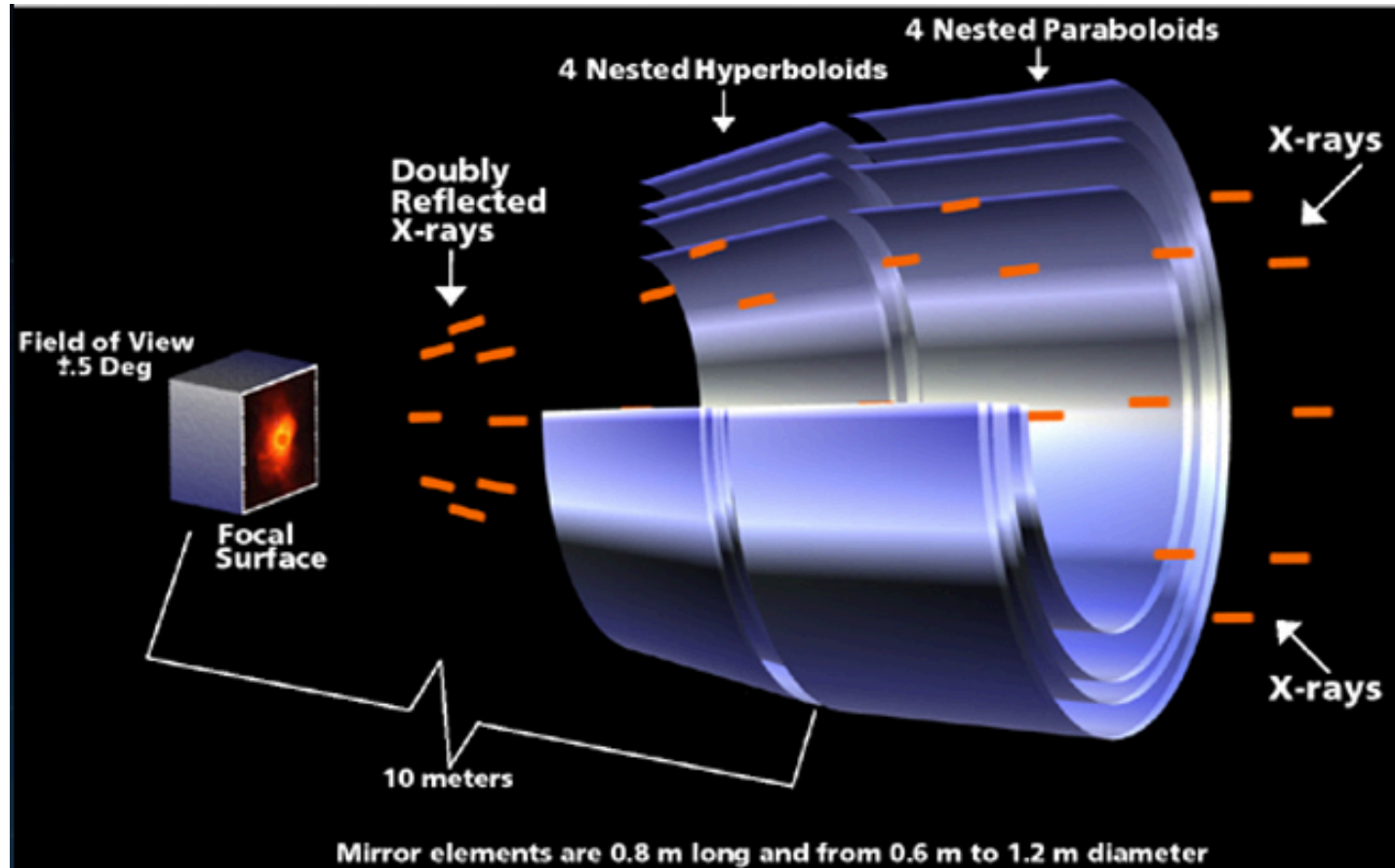

- Wavelength coverage: $0.1\text{keV} > 10. \text{keV}$ ($124\text{\AA} > 1.24\text{\AA}$)
- Total Mirror Surface Area: Approx 20m^2 (75% of JWST Primary Mirror)
- Telescope (Only) Effective Area: $\sim 0.075\text{m}^2$ (within 1 arc sec diameter)
 - Note that the effective area is driven by the very small annular aperture at the front of the paraboloid (or primary optic)

Hypothetical Telescope Parameters Based on Science Needs

- **A starting point for mirror telescope designers has been proposed as shown below:**

Initial Mirror Assembly Constraints:

- Maximum outer diameter of largest optical surface: 3.0m
- Focal lengths (point design for each of the four focal lengths): 5m, 10m, 15m, and 20m
- Field-of-View: 10 arc min radius @1 keV, with less than 20% drop in geometric area due to vignetting
- Point Spread Function (PSF)
 - On-axis: at least 0.5 arc-sec HPD on-axis
 - Off-axis: at least 0.7 arc sec HPD out to a radius of 5 arc-min
- **On top of these initial mirror assembly constraints is the necessary collecting area to meet science needs. Today that number is in the 1-3m² range which means that it is, on average about 13-40 times more that the Chandra Telescope collecting area (or 10 to 30 times more than JWST) and implies a total optic surface area of order 260-800m² *Quite a challenge !***

Nominal Working Error Budget

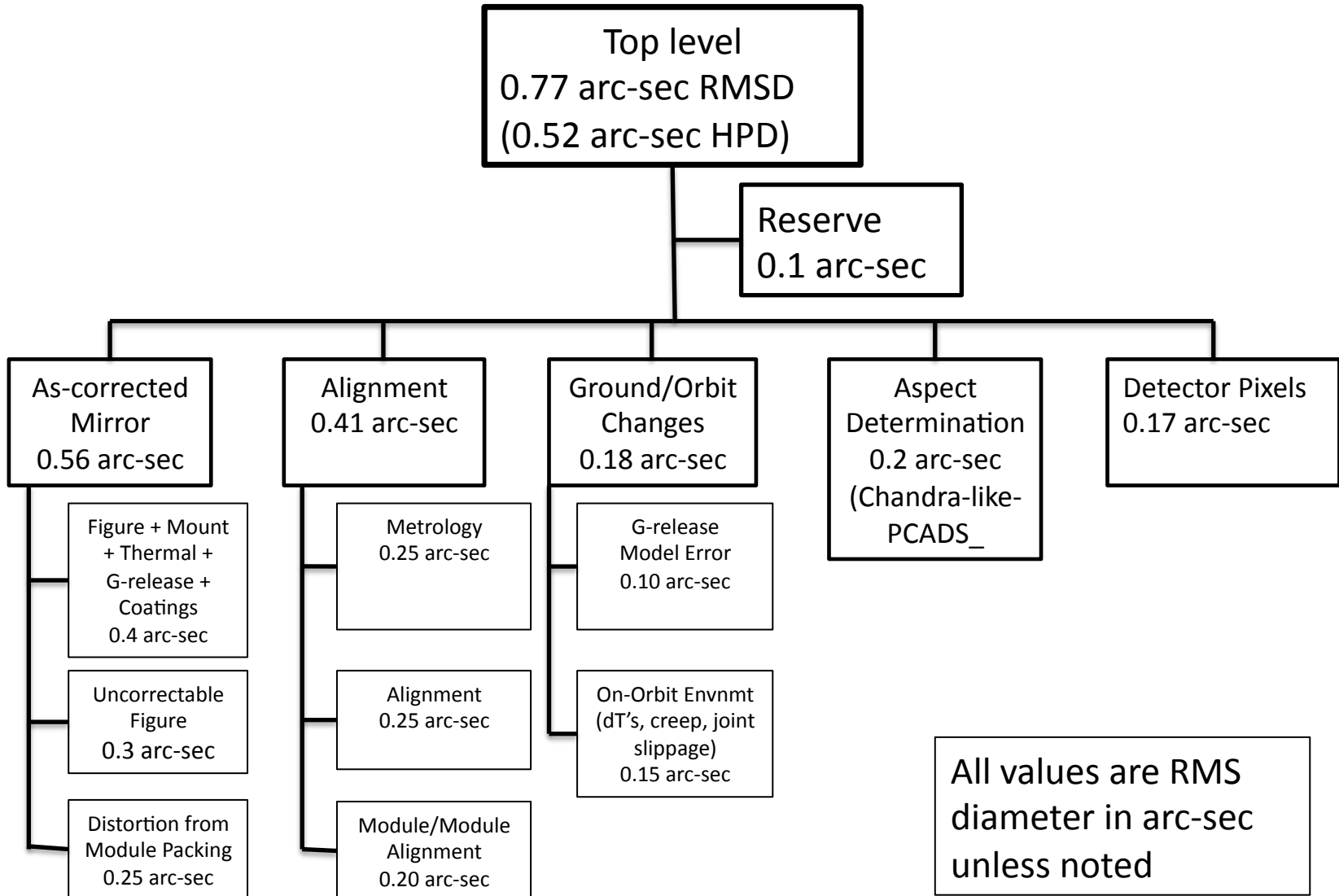

Taxonomy of X-ray Telescope Fabrication

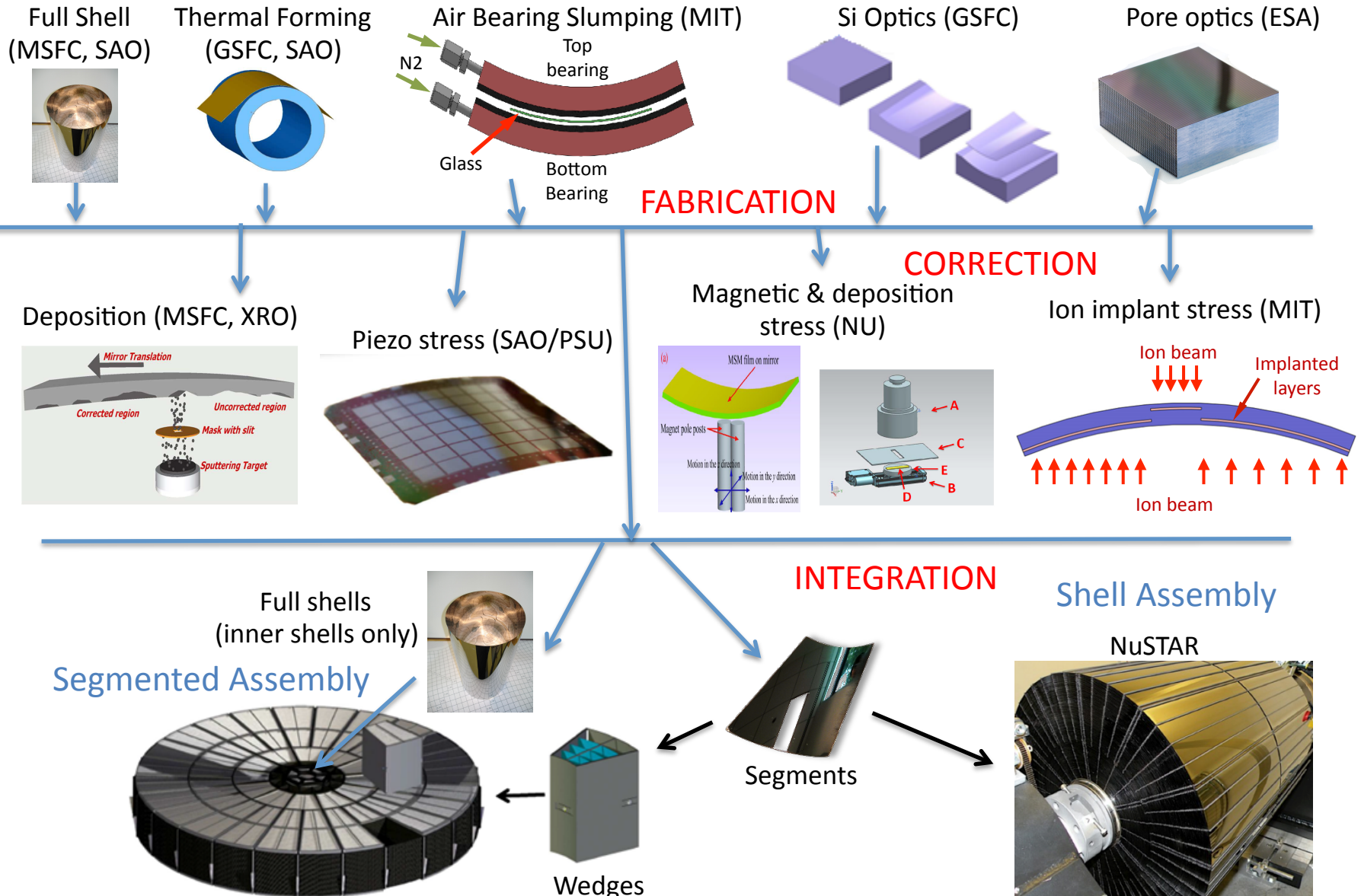

XRS Mirror Development - 1

Viable mirror geometries for XRS include Chandra-like full shells (either separate Primary (P) & Secondary (S) segments or one-piece construction) or....

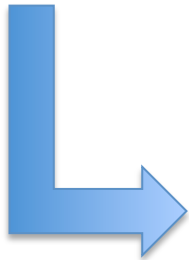
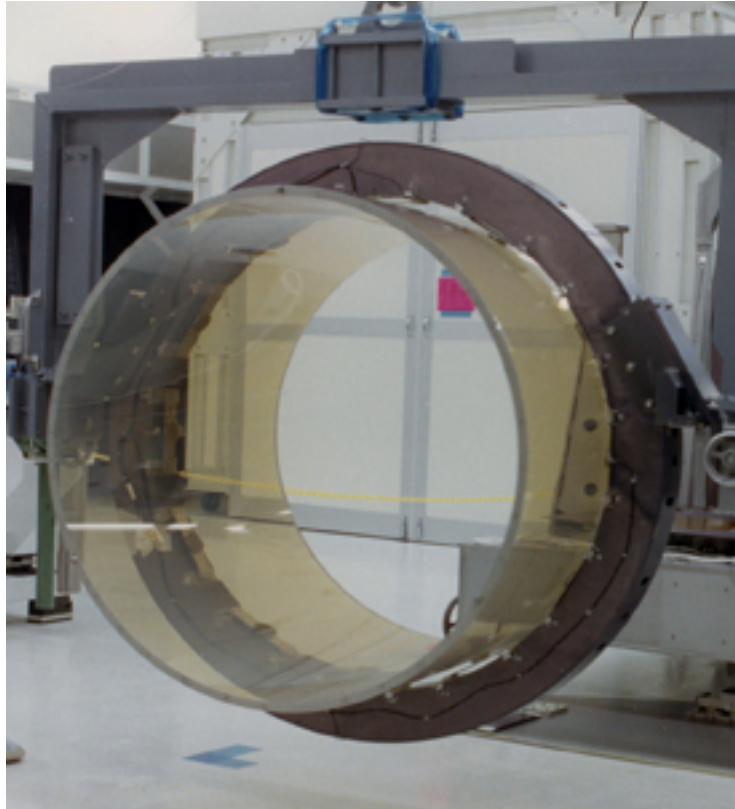

XRS Mirror Development

- ...individual P/S segments such as were used in NuSTAR.

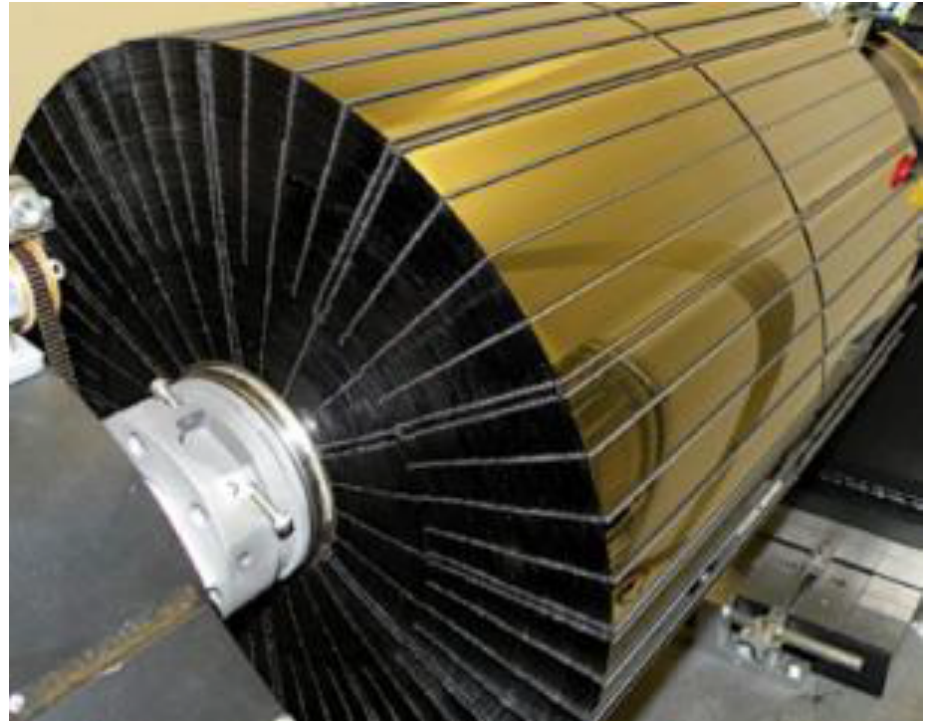
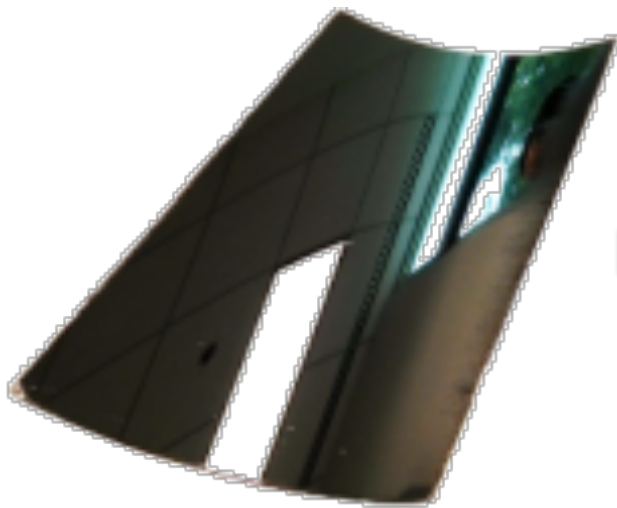

Full Shell Mirrors -1

- Given the desired mirror collecting area and the current nominal telescope parameters , each mirror will have to be in ***the millimeter thickness class***.
 - To date mirror shells have been made out of SiC, Ni, & glass but ***not*** at this thickness.
 - BeAl is also now being considered (by NASA MSFC).
- Full shell manufacturing techniques include CVD deposited SiC , electroformed nickel and glass shell slumping. Other TBD processes may be developed.
- Focusing on ***one*** material (glass) and ***one*** manufacturing method (Obs. Brera) can help us understand the many obstacles that need to be overcome by ***all*** candidate materials/techniques. So, by ***example***:
 - Glass (ULE or equivalent) mirrors are thermally formed & then ground & polished using standard optical processing but quite sophisticated tools, metrology and support hardware. To date, the best mirror has been about 15 arc-sec of which half could be explained by known problems. Significant insight into each process parameter is needed to understand the limitation (s) of each process. A study of these processes has just begun through the XRS Study Office. The initial study plan is shown in the Appendix.

Full Shells - 3

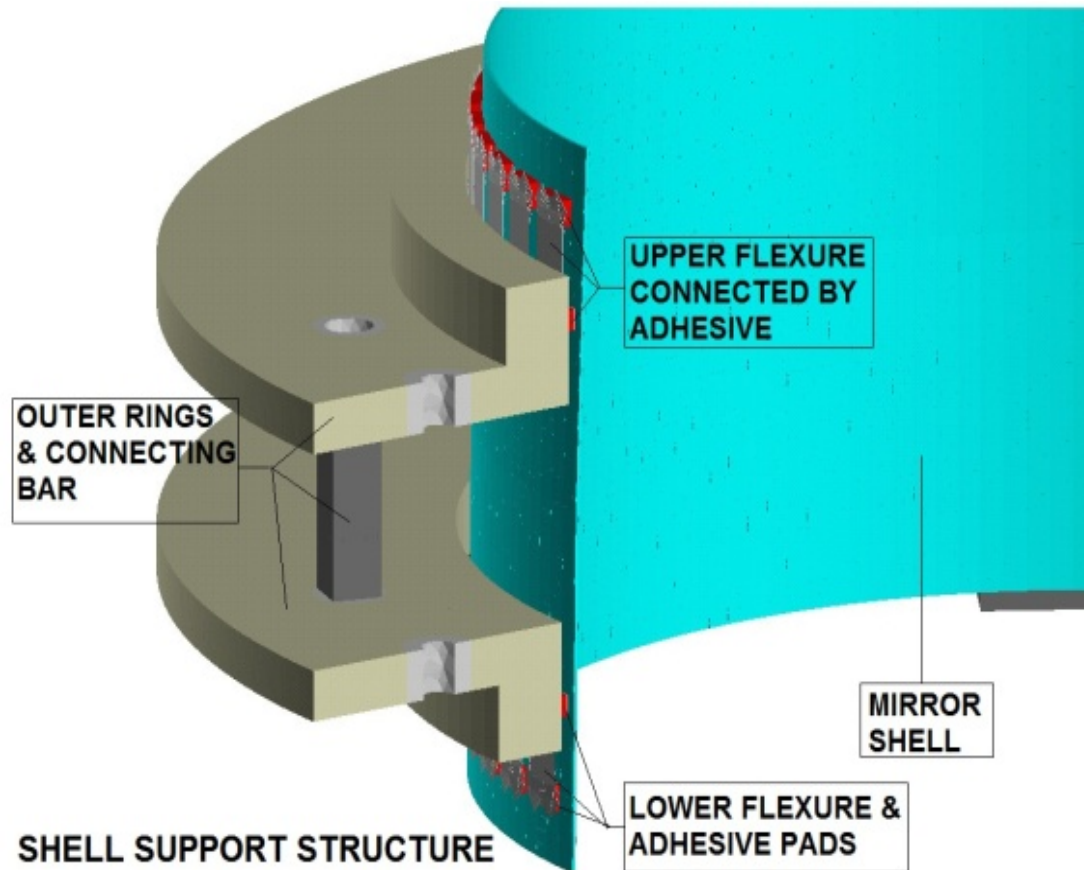

CAD Model of an Actual Test Mirror & Manufacturing Support System

Ref: O. Citterio et al, "Thin Fused Silica Optics..."

Segmented Mirrors -1

- Come in **two** flavors: manufacture & forget (prior to being mounted) & post manufacture active re-figure (after being mounted).
- In the manufacture & forget category are single crystal silicon segments currently being worked on by NASA/GSFC and glass slumped mirrors. In the case of both of these mirror technologies, if the initial process cannot get the figure down to less than the error budget requirement, other correction techniques have been and continue to be researched. These include:
 - Ion figuring (ie...remove the mountain peaks)
 - Ion figuring + Differential Deposition (ie... fill in the pot holes)
 - Ion implantation (which produces a surface stress that is designed to apply localized 2-D bending moments (surface stress X stress layer thickness x $\frac{1}{2}$ shell thickness) to locally correct the figure.
- To date, the silicon mirrors, per published reports, seem to have produced mirrors with a **few** arc sec resolution (unknown if this means a single mirror or a P/S pair). Developers schedule has set a target of <1 arc-sec before 2020.

Segmented Mirrors - 2



Wolter-I Mirror

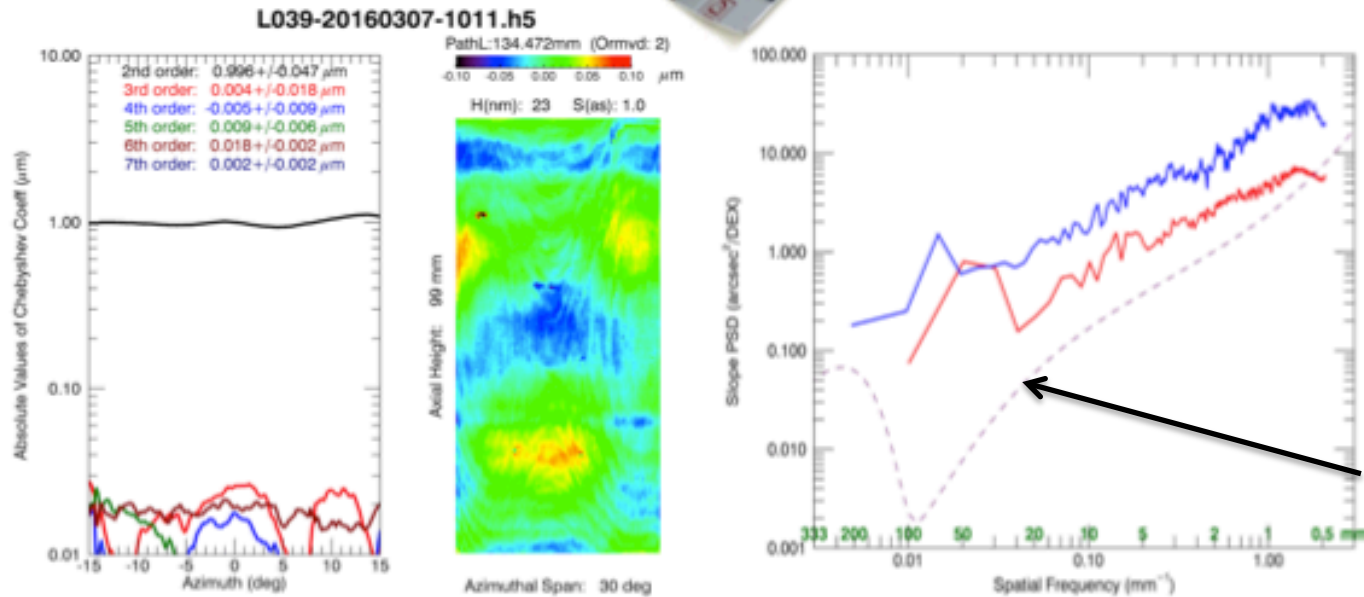

Chandra

William W. Zhang NASA/GSFC

10

Segmented Mirrors - 3

- Active segmented mirrors include segments with back-surface Piezo (PZT) or PMN elements arrayed such that each addressable area can be stressed/strained to induce local curvature to correct the low and mid-frequency figure errors of , for example, slumped glass. Some of these active systems are more temporally stable than others. To date, none have been show to be stable enough that they would not need re-figuring at some point in time. The addition of very high sensitivity strain gauges (per methods used by Xinetics) may provide absolute references that would allow re-figuring at necessary intervals back to their initial acceptable figure state.
- To date, the best *single* piece of slumped glass produced by the SAO PZT team is ~10-15 arc sec (prior to the PZT being applied). Currently this value is a factor of ~1.5 times *too* high to be corrected by the PZT actuators.

Segmented Mirrors - 4

What are *adjustable* X-ray optics?



SAO

Schematic X-section

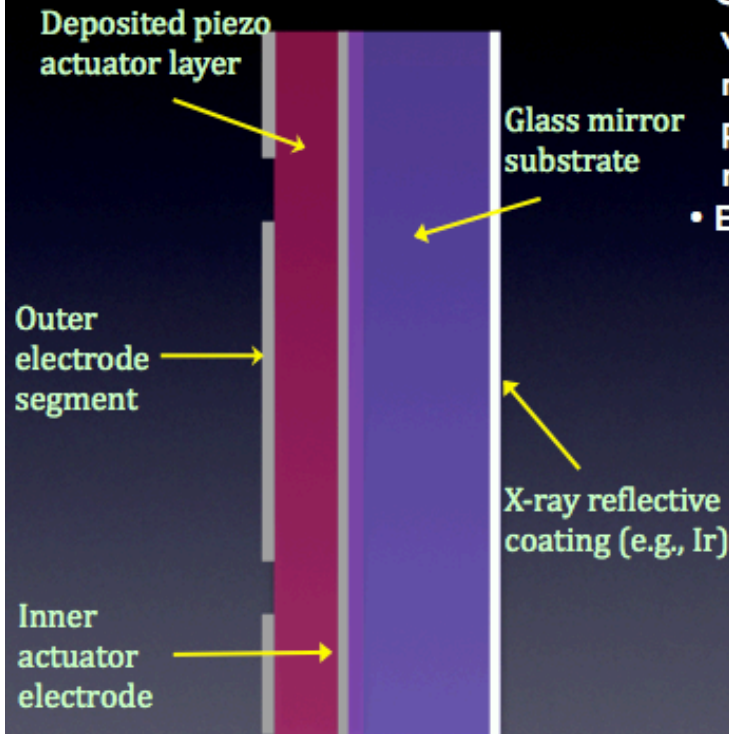

- Continuous thin film (1.5 μm) piezo actuators with independently addressable electrodes on mirror substrate. Low (<10) DC voltage thru piezo thickness produces in-plane stress in piezo, resulting in localized bending of mirror.
- Enables efficient correction of mirror figure for:
 - fabrication errors
 - mounting induced distortions
 - *on-orbit* changes due to thermal environment
 - *on-orbit* correction enabled by integral strain gauges directly on piezo cells (later).

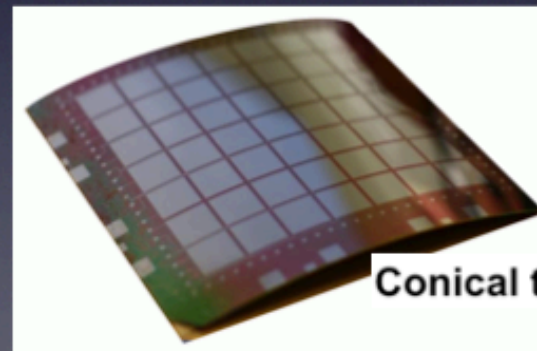

Conical test mirror

Reflective Coating Effects on Thin Shell Optics

- Regardless of how low stress coating experts say their coating stress is, it is **NOT** nearly low enough to be neglected. This will drive, by necessity, to not only properly account for the coating stress, but to account for its uniformity and its differential uniformity if a “balancing” layer is applied to the back surface of the optic.
- To give you an idea of the deformation than can take place, a stress of $\sim 3.5\text{Mpa}$ (500 psi) in a 50nm (500Å) thick coating can cause a P-V deformation of order $1\mu\text{m}$ in a nominal mirror segment that is 0.5mm thick. While some of this deformation can be removed by proper alignment it can still cause a significant error budget hit.
 - Coating stress is much more of an issue with segmented optics than in full shell optics (and especially in one piece full shell optics). In full shell optics, deformation states like $\Delta\Delta R$ (imagine squeezing a cylinder at one end so that it ovalizes. The other end will ovalize at 90deg to the opposite end and will produce almost no figure error of the combined P/S optic).

Assembly & Alignment Considerations -1

- To understand the scale of mis-alignments/deformations that are important to segmented optics (full shell optics are much less susceptible to these effects & they dampen out differently) , a 0.1um motion normal to the surface of a 0.1m long segmented primary optic can tilt the optic by about 0.2 arc sec and IF the secondary optic did the mirror image, the HPD would be of order 1 arc sec or > 4X the assembly & alignment budget. So alignment tolerances will be << 0.1um.
 - NASA/GSFC has proposed a META-SHELL approach for their segments. In this approach, each mirror segment sits on optimally spaced supports which have been precisely machined/polished/figured to the nano-meter location level. This is a unique approach which will require additional R & D.
 - A support concept suggested by SAO has each optic installed in a support frame (in a near 0-g state) via flexures prior to it being aligned into a module/housing. The benefit of this concept is that it puts the mirror segment further away from racking-type deformations which can be caused during launch. This concept will also require additional R & D.

Assembly & Alignment Considerations -2



Alignment and Bonding Concept



Each mirror kinematically supported to minimize distortion.

Implementation and testing underway. Initial results by December 2016.

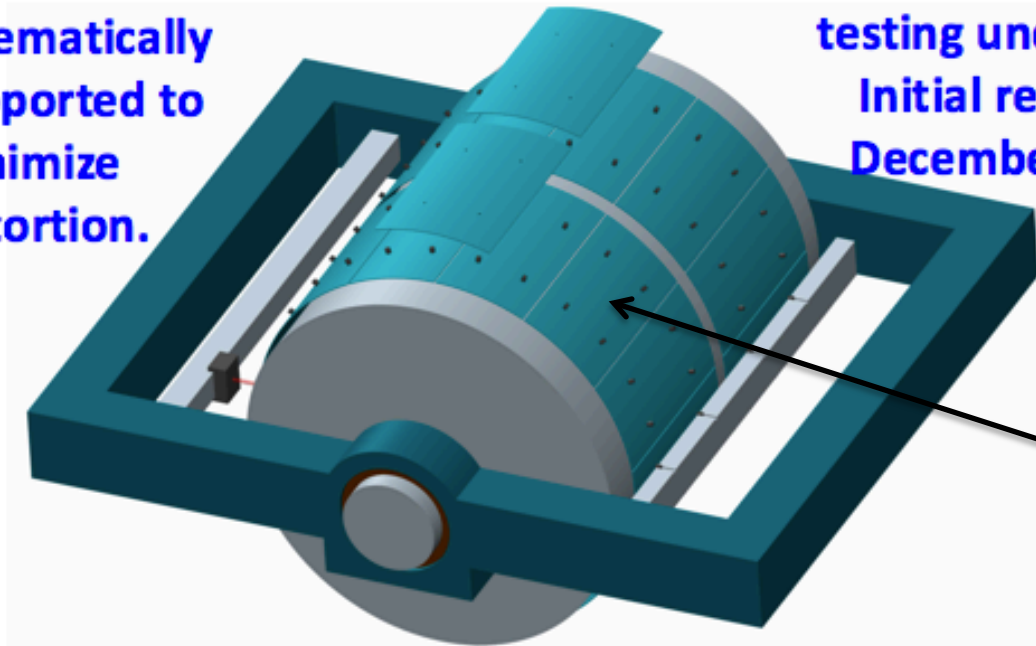

Updated I/F is a 3-pt mount NOT a 4-pt mount

Assembly & Alignment Considerations -3

Segmented Mirror Frame

- In Ti6Al4V, mass = 28 grams

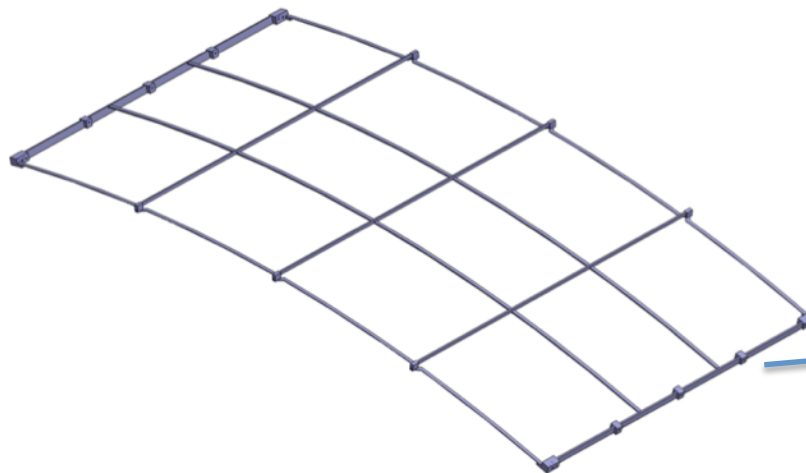

Conceptual Side Clip Geometry

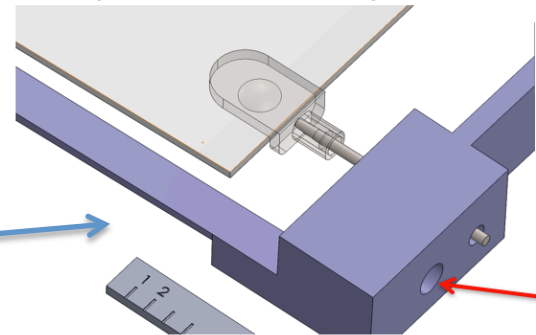

- Dimple on underside of clip is partially filled w/ adhesive. As the adhesive cures it preloads the clip/mirror interface. This takes the epoxy out of the distortion path.
- Offset of the pin/flexure in its thru hole on the order of 50um to 100um is tolerable from a deformation point of view if epoxy was used

14

Ref: L. Cohen, JPL Decadal Mtg, June 2016

Industrial Opportunities

- XRS will require hundreds of full shell X-ray mirrors or thousands of X-ray mirror segments. And all of these fabricated mirrors will have to be done using the benefit of “mass production techniques”.
 - XRS will be a BIG NASA Project and aerospace firms and other companies are interested in BIG NASA programs
 - Industry has the capability & depth to significantly support efforts like XRS.
 - To date, most if not all XRS mirror development has been done by small research groups. We need to create the right environment (\$\$\$) such that large companies can support the transition from small lab to large manufacturing facilities along with all of the know how developed at these small facilities.
 - The XRS optics roadmap, if developed properly, will create the right conditions (i.e., significant funding available over several years) that large companies can support the transition from small lab to large manufacturing facilities along with the know how developed at these small labs

Summary

- Significant challenges remain for all X-ray optics groups
- Each group IS headed in the right direction
- A concerted effort is required to assess and synthesize results from current & future R & D programs and analytical studies as we head towards our decadal submittal in 2019. We **INVITE** participation on all levels.
 - ***Please contact lcohen@cfa.harvard.edu***
- Companies from numerous industries need to get on board as soon as possible and NASA has to help with making them want to help !

Appendix

Preliminary Full Shell Study Plan

- 1) Evaluation of the amount of internal stress in the shells after the rough grinding
- 2) Deformations of the shells using the supporting jig (used to handle and sustain the shells in all the operation prior the final flight integration). An improved design with respect to the current jig needs to be studied
- 3) Investigation of the deformation effects due to shrinkage, stiffness & CTE of the silicone adhesive used to fix the flexures of the temporary static jig to the shell of the current design
- 4) Even with the use of “stress free” temporary jig, it could be that additional internal stresses are generated during the fine grinding and polishing operations. One should investigate a realistic situation assuming a matrix of the errors induced by the stresses generated by the optical manufacturing process and evaluate the effects on imaging quality of the shell on the temporary jig and after the transfer to the spiders of the final flight assembly. These analytical investigations may benefit from actual material testing.
- 5) Verification that the ion figuring method can be successfully applied for the correction of close shells (including the study of the possible internal stress caused by or released by the process)
- 6) Study on the “surface damage” due to the different grinding and optical polishing operations on both sides of the shell walls and how to remove it. This study is related to actual fabrication processes as well as the residual stress/figure deformation process.
- 7) Update of the error budget for the shell production (Note: there are previous studies performed for the WFXT mission, but they were done assuming a goal of 5 arcsec HEW and not 0.5 arcsec HEW)
- 8) Update of the production process, including an assessment of the maximum diameter that can be realized with the closed shell approach (this investigation should be carried out with contacts with the industries providing the rough SiO₂ mirror shells and the polishing systems)