

NASA Alternative Orion Small Cell Battery Design Support November 16, 2016

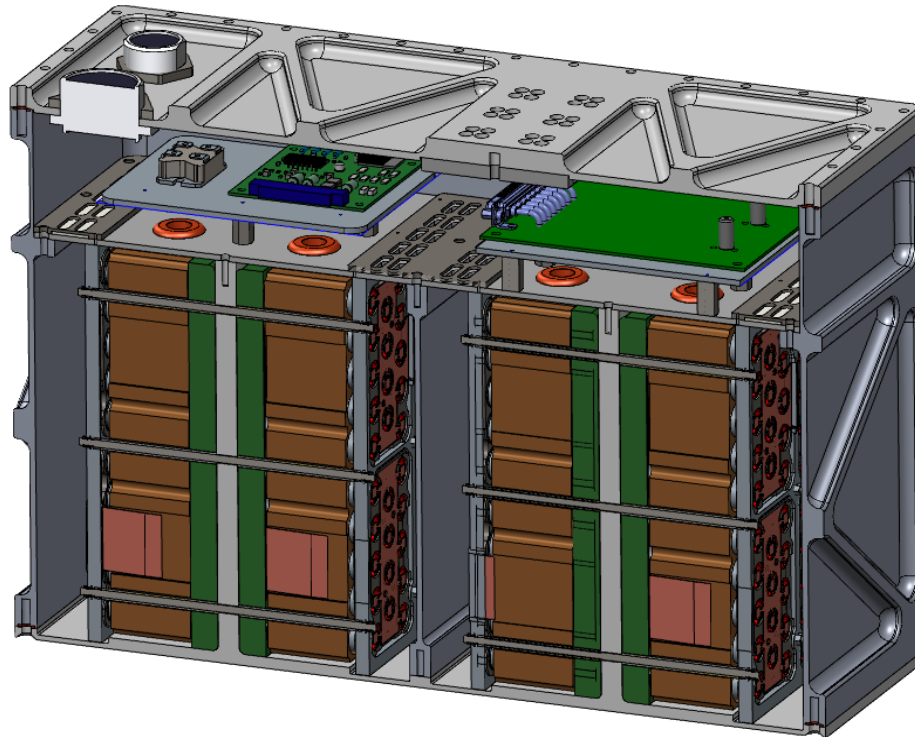

Presenter: [Chuck Haynes](#)
Propulsion and Power Division - Power Systems Branch EP5
NASA Johnson Space Center
2101 NASA Parkway; Houston, TX 77058
Phone: (281) 244-0985

CM Battery On-Ramp Decision for EM-2 Background

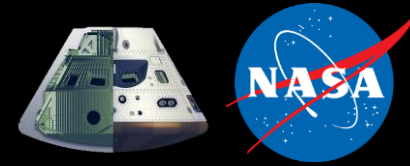

- ❖ MPCV Orion proposed design for CM Battery that would put in place specific controls to prevent thermal run-away (TR) propagation after a single cell TR event and thereby avoid a large scale fire/explosive hazard, and eliminate potentially cascading concerns to the ATCS cooling loop and other Spacecraft systems
- ❖ NASA JSC Power and Wiring was authorized by MPCV APS IPT to perform development of a small cell battery as an alternative, with the intent to demonstrate fail safe features that would preclude TR propagation without impact to Spacecraft systems
- ❖ NASA performed a first set of feasibility tests in early 2015 that showed enough promise and interest to gain collaborative funding from the Orion Program and the NESC to perform further development and testing approaching flight-like design
- ❖ The Orion Small Cell Battery (OSCB) Development Test Article phase 1 (DTA1) project team analyzed, designed, built and completed testing of the DTA1 full-scale hardware.
- ❖ A summary of the OSCB DTA1 project results were provided to the Orion Program, as a design reference for an inherently safe small cell battery design for EM2.
- ❖ OSCB DTA phase 2 DTA2 updated design and development tests were funded in FY16 to further design and perform Struct & Mech environmental testing to support PDR readiness

CMB Large Cell TR Propagation Testing

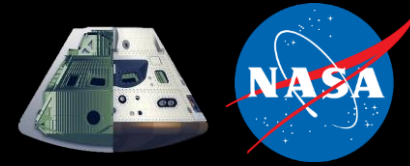

- **Thermal runaway tests performed in Sept 2014 demonstrated that single cell TR ruptures burst disc and causes venting, and propagates to neighboring cells**
 - Flight type battery case, populated with 14 of 32 cells
 - Single cell forced into TR
 - TR propagated to 7 neighbor cells with Flame through burst disk

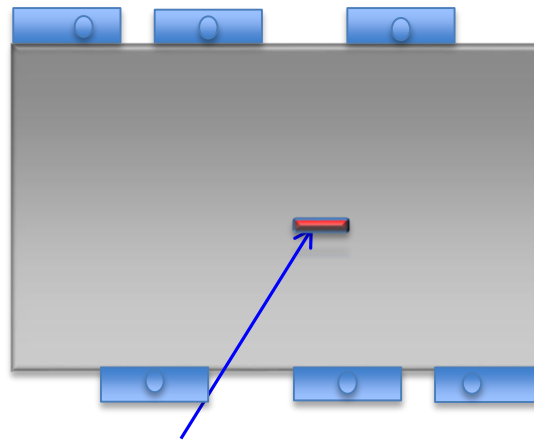

Top View Illustration showing approximate location of Cell that was triggered to TR



Orion Small Cell Battery Early Development Test Background

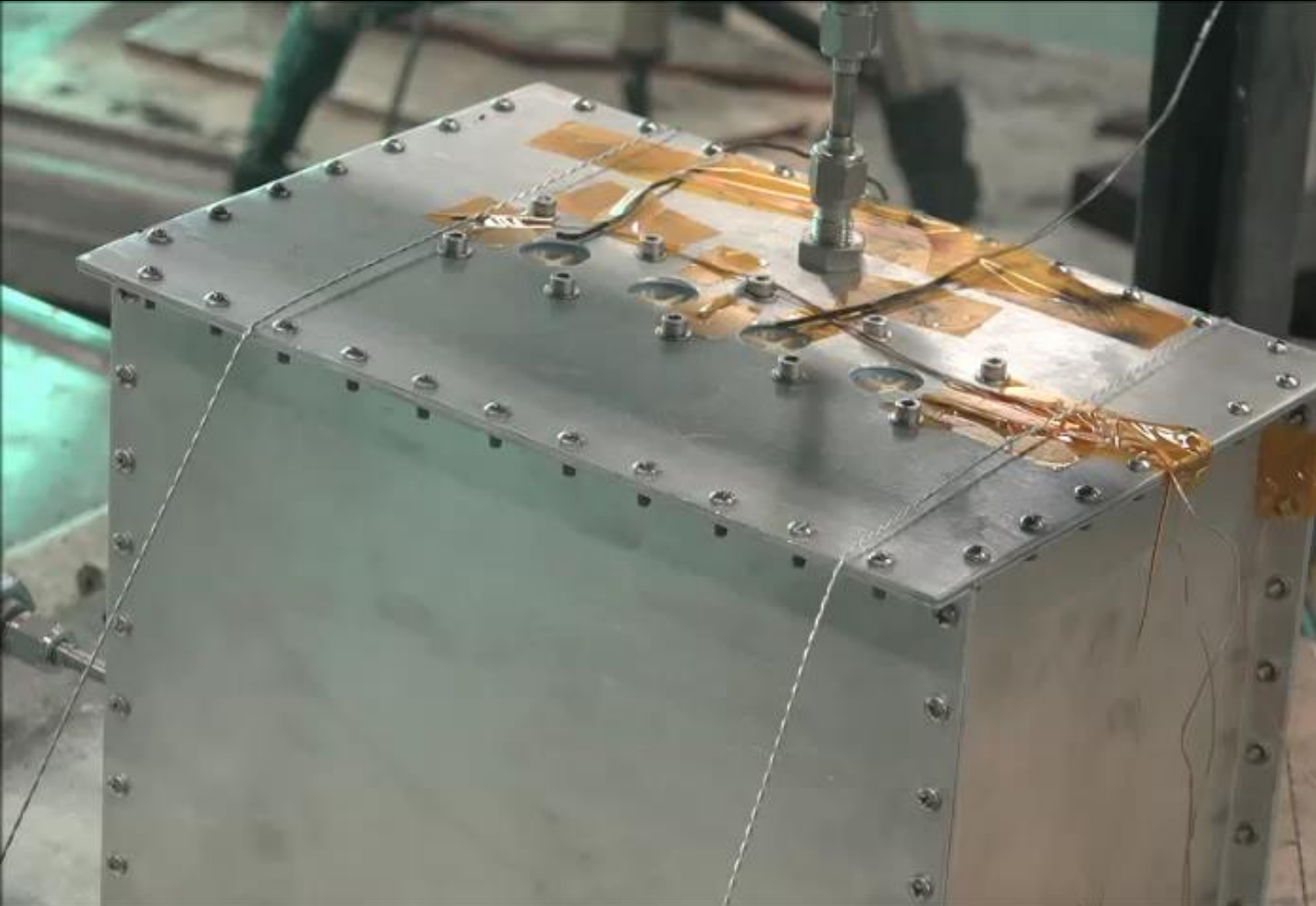
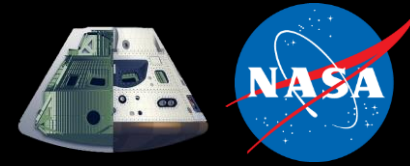

Video June 2015 Test Orion Small Cell Battery TR Propagation Proto-case run #9 used to successfully demonstrate Gore Vent approach.

Small Cell Battery Safety demo notes:

Runs 1-6 Performed in succession no TR propagation

Run 7 Resulted in TR propagation

Most likely Causes Identified:

- side can failure mode direct flame impingement
- over-test due to collateral damage from 6 prior events
- unfairly biasing neighbor cell temperature with slow heater

Run 8 TR recreating Run 7 conditions but with insulating foam and resulted in no propagation

Battery SuperBrick Packaging

14P- Virtual Cell Sub-block Components (DTA1 shown)

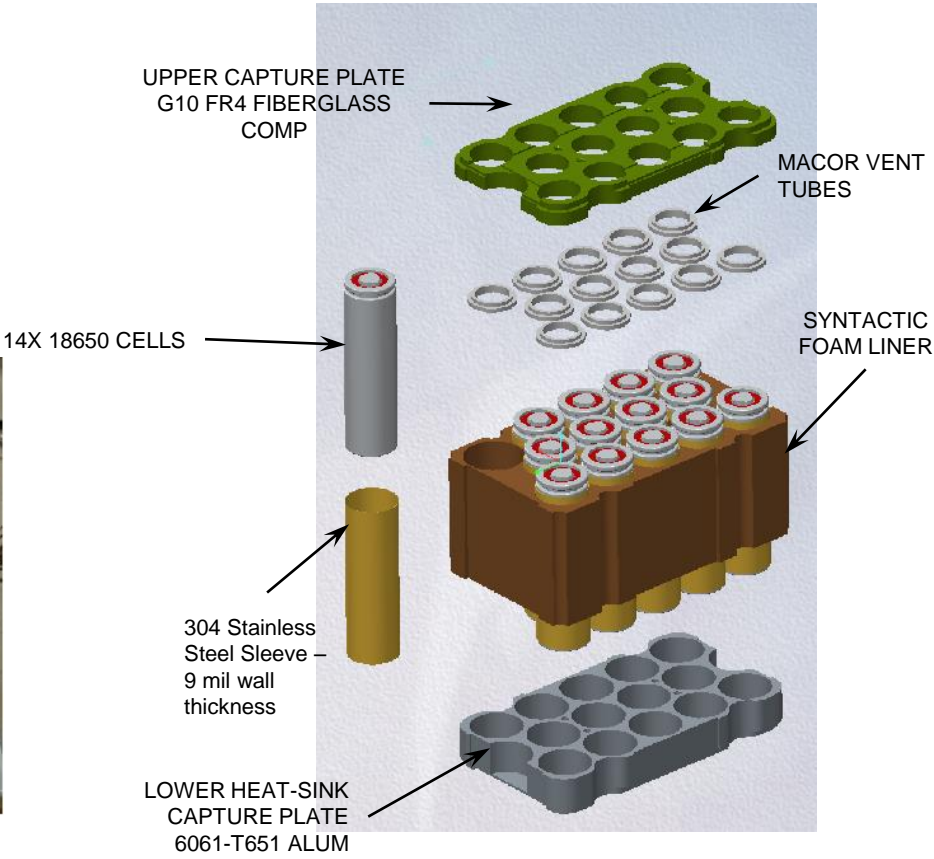
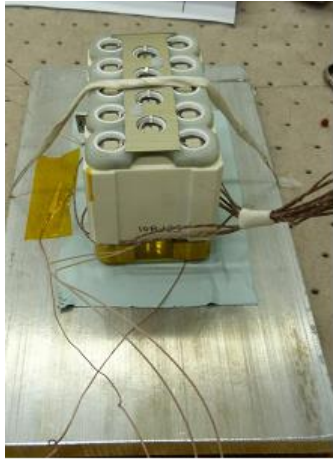
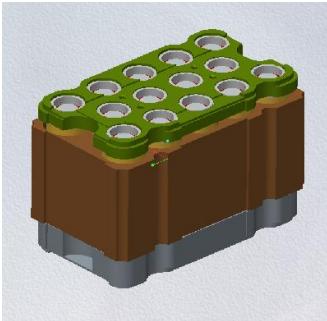
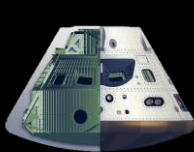

Battery SuperBrick Packaging

112-Cell Outer Dimensions: 10.04" x 8.58" x 2.82"

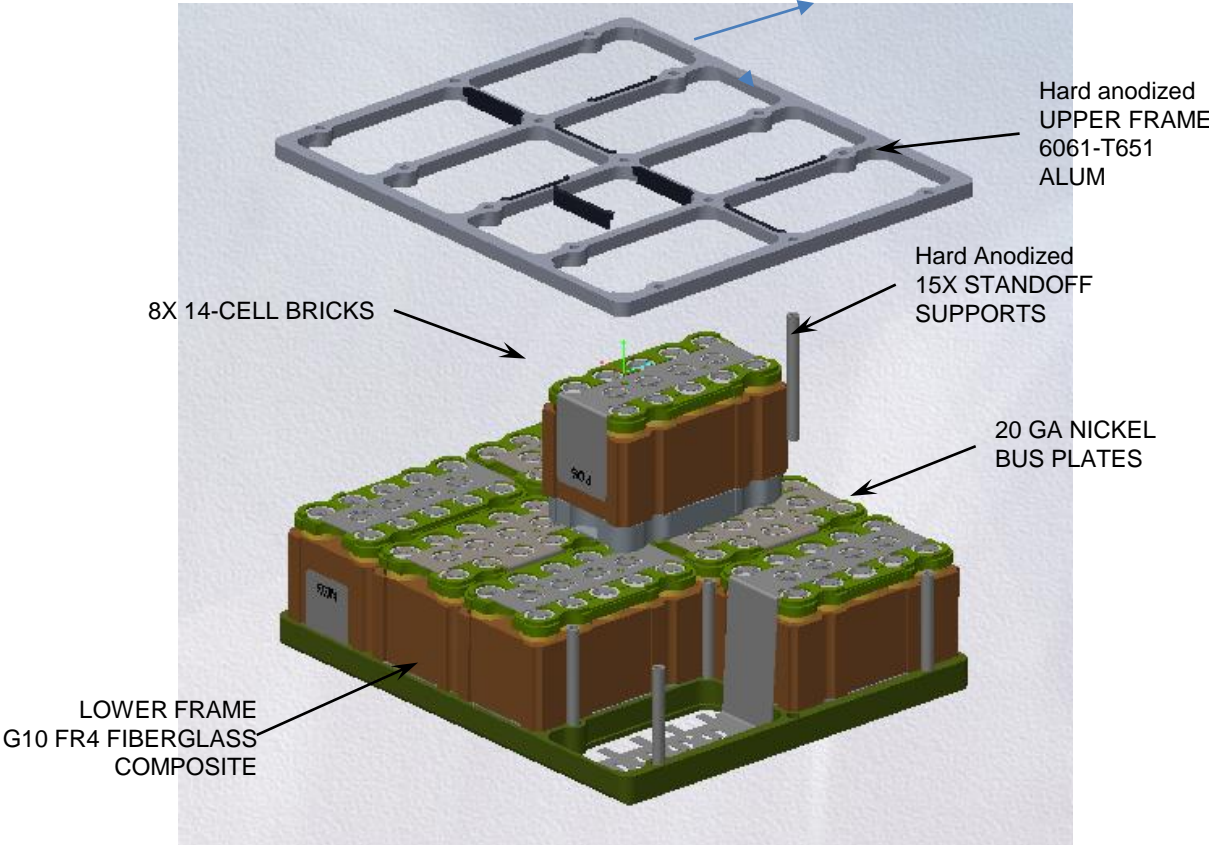
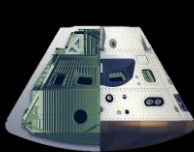

Project Management:
• Chuck Haynes/EP 5
• 832.221.4268, charles.s.Haynes@nasa.gov

Small Cell Crew Module Battery Development Test Article 2 Design Demonstration Abort
Vibration and PryoShock Testing

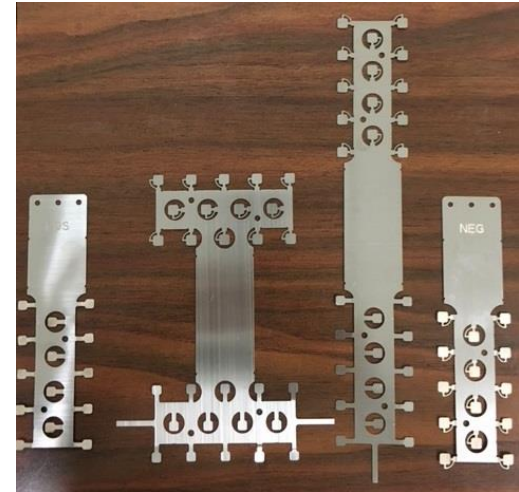
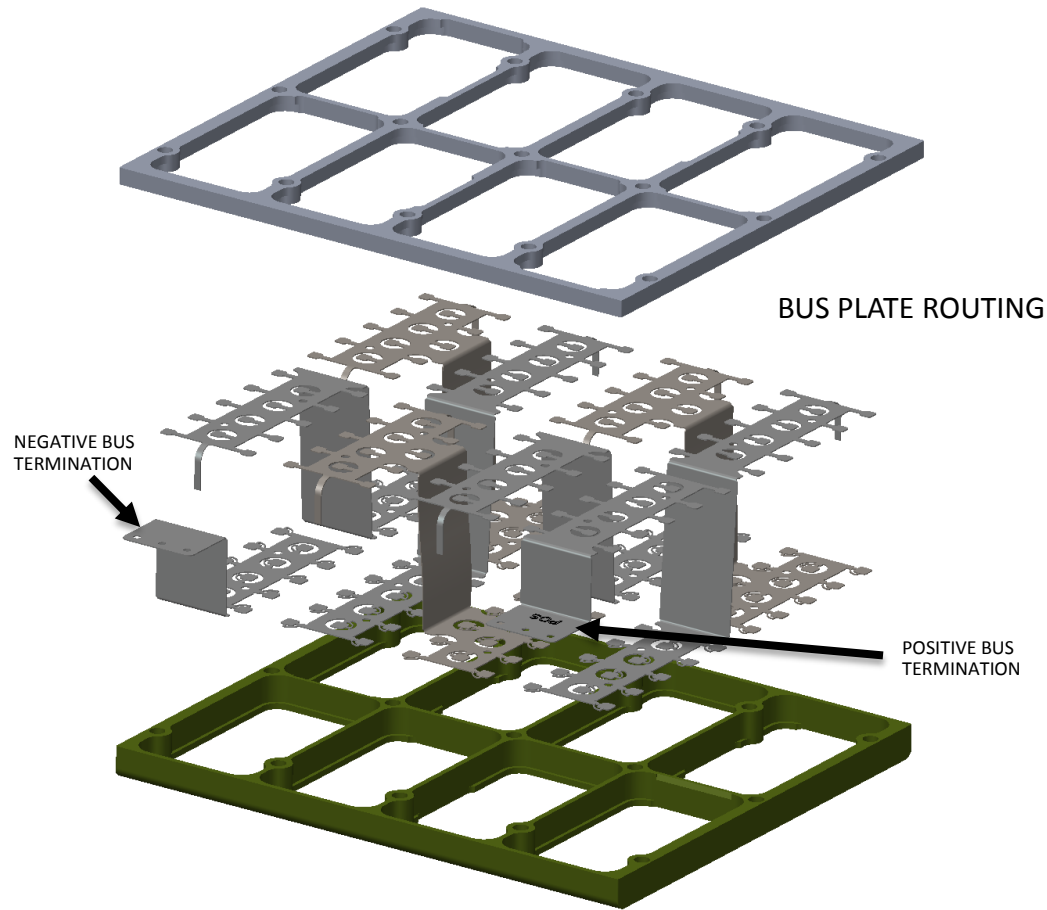
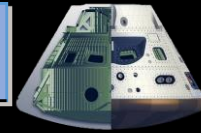

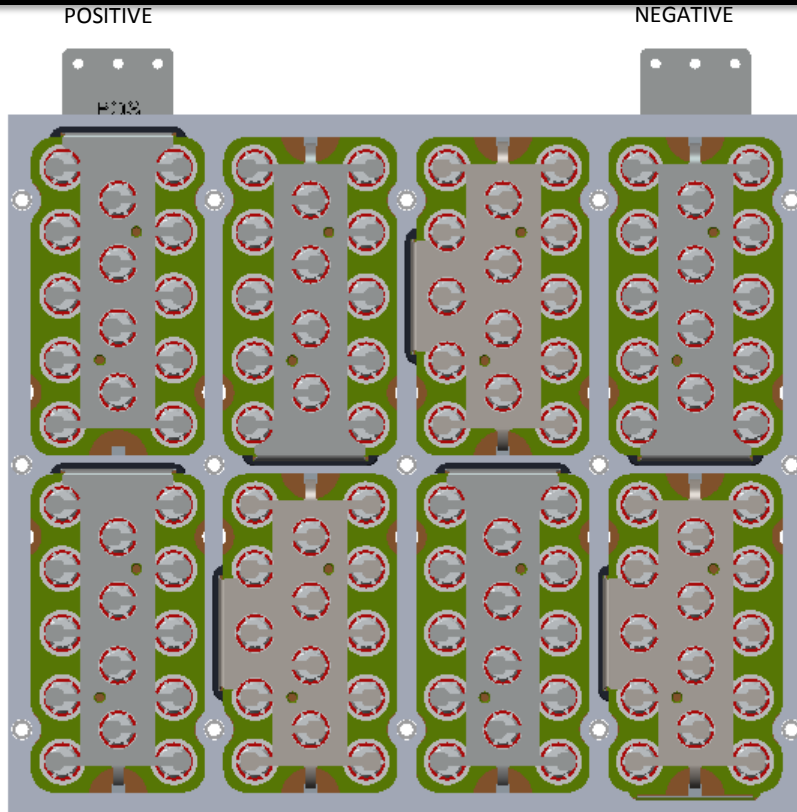
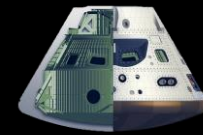

TOP VIEW

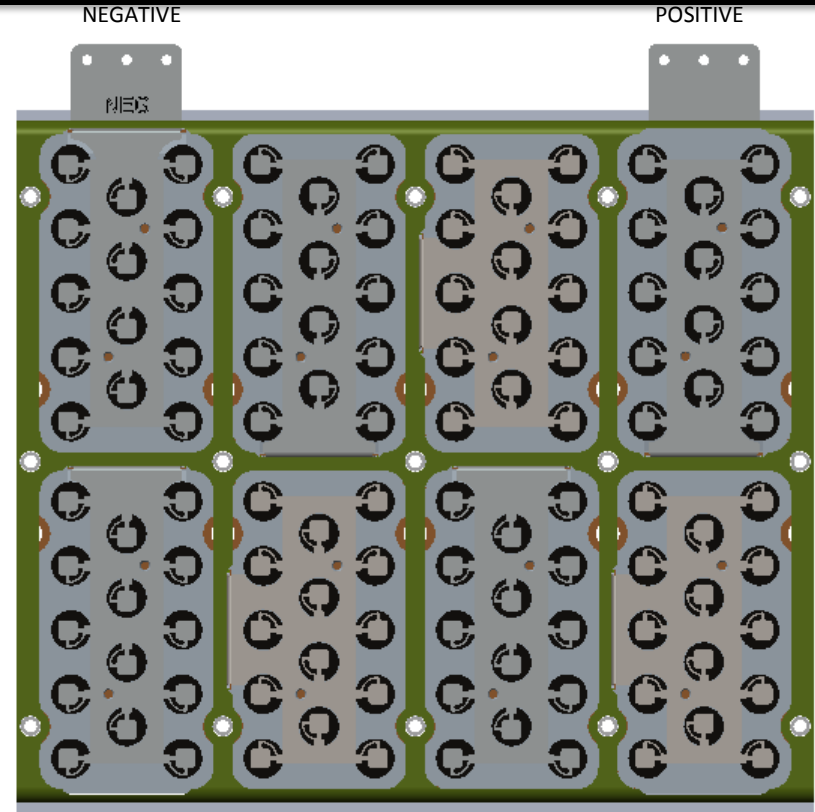

BOTTOM VIEW

Crew Module Battery Performance Spec Description	Performance Based on 32Vdc SuperBrick 14P-8S Acceptance Testing
Voltage Range	104.0 V to 131.2 V
Beginning of Life Energy, 68F:	>4600 Wh @ 6 A, >3675 Wh @ 30 A
Beginning of Life Resistance, 25 A, 50F	<200 mOhms based on assessment of DC Resistance measurements
Vibration (Abort Normal)	49.1 GMRS, To Be Addressed by Development Test Article 2 Testing

DTA1 Full-Scale Housing Internal Construction

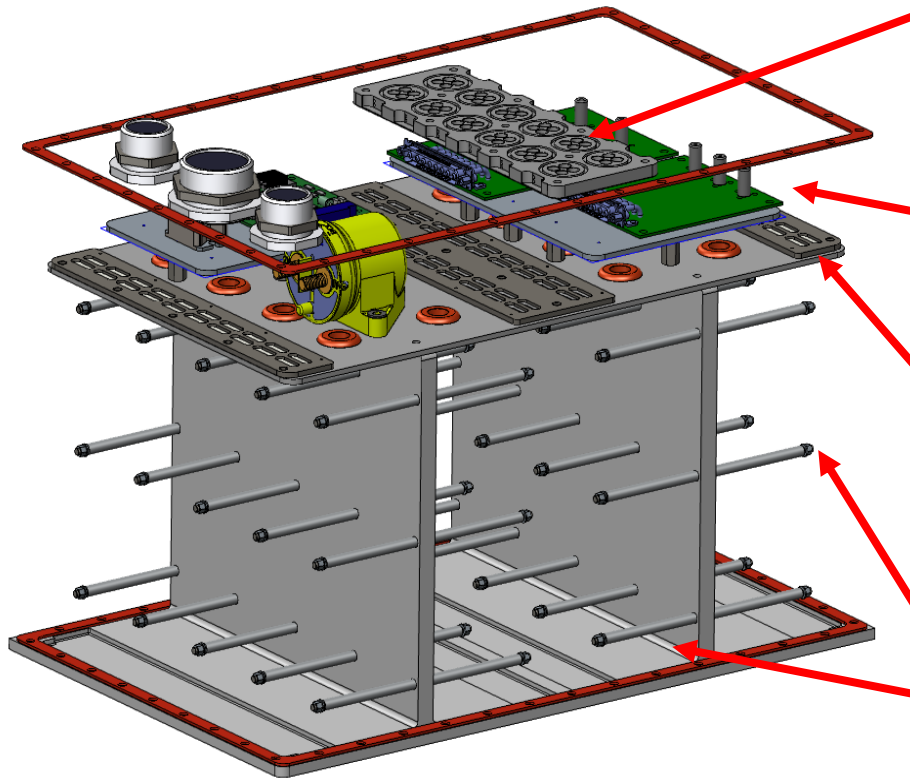
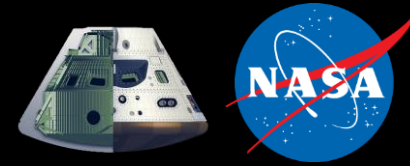

Gore Vent apparatus allows for pressure management with hydrophobic features to prevent water intrusion. Underneath the Gore Vent there is a layer of Nextel AF14 for enhanced effluent particulate suppression.

Upper Battery volume utilized for mounting electronics and wire harness routing and provides void volume air exchange.

Filter plate in top tray provides vent path from lower battery compartment to upper battery volume. Filter materials are sandwiched between plate and include metal mesh (30 Monel) and Nextel Fabric (AF-14) for flame suppression and heat spreading..

Tie Rods 15x provide SuperBrick mechanical mounting for thermal gap compression.

Housing base for cold-plate mounting of the CM Battery is constructed with vertical $\frac{1}{2}$ " thick thermal path for SuperBrick attachment as a single piece of Aluminum.

DTA1 Full-Scale Housing Cross Section

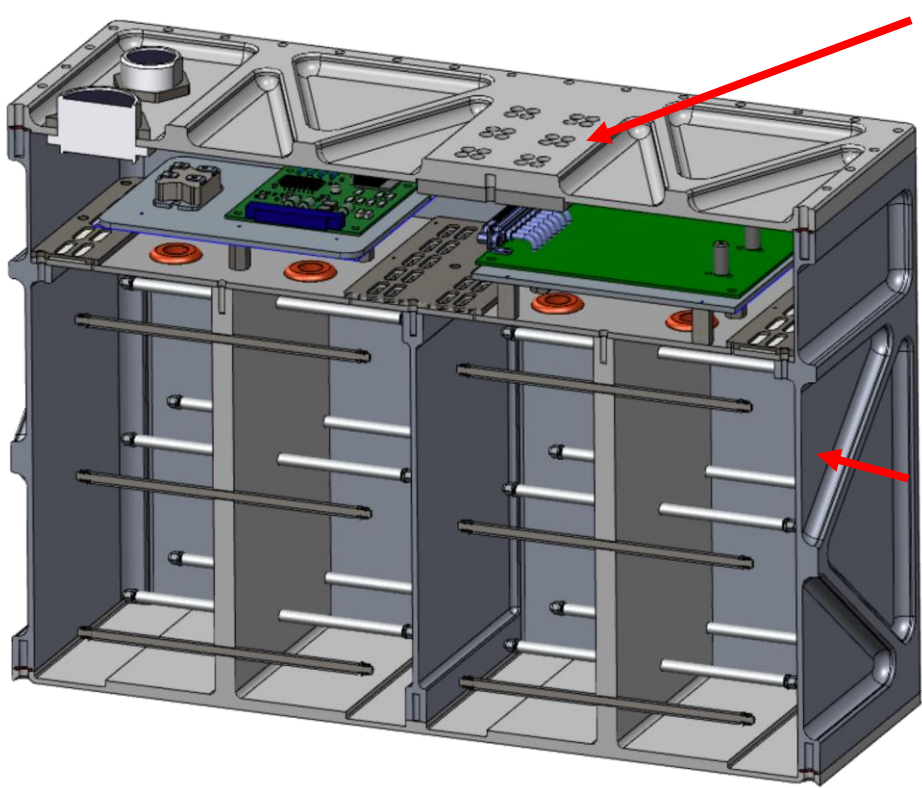
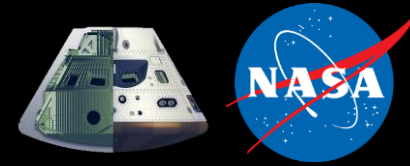

Gore Vent apparatus external cover vent port holes 12x provide box pressure management.

Side housing is constructed of a single piece of aluminum to form the exterior walls and interior partition between SuperBricks.

DTA1 Full-Scale Housing with SuperBrick

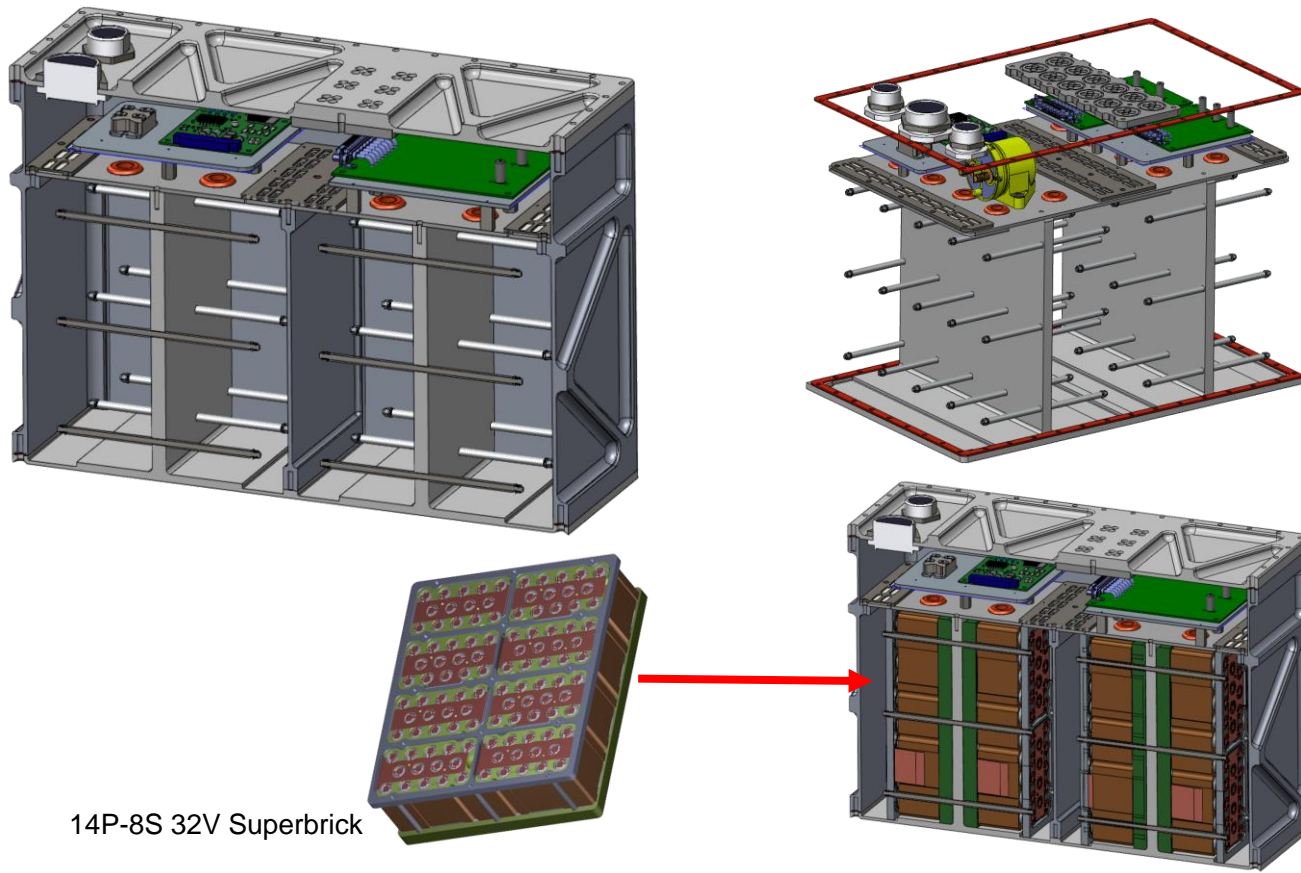
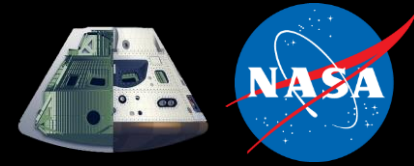

14P-8S 32V Superbrick

DTA1 Full-Scale Housing (CAD & As-Built)

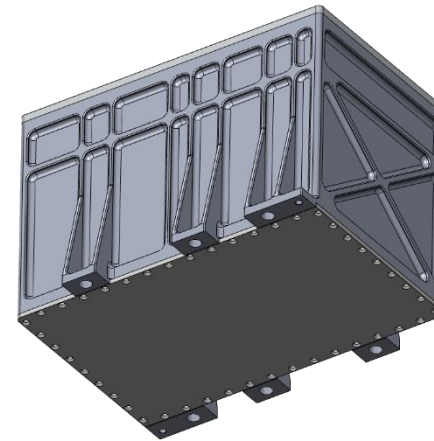
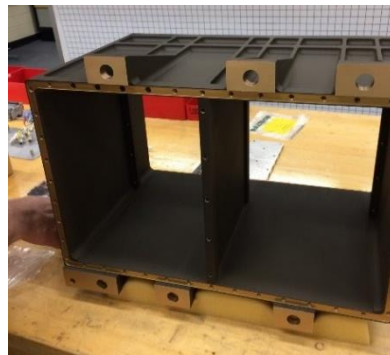
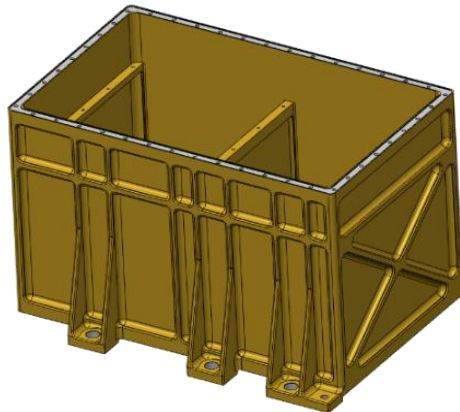
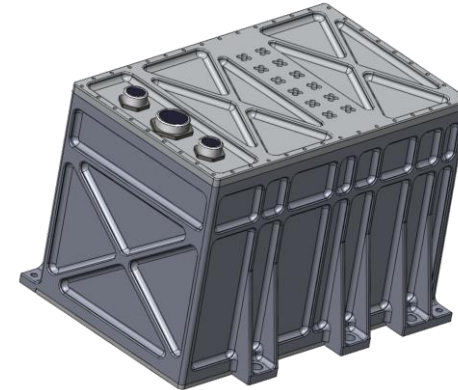
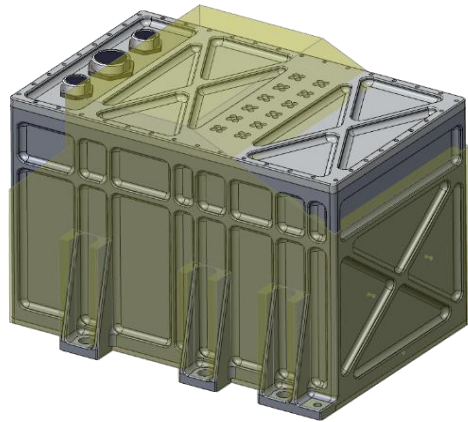
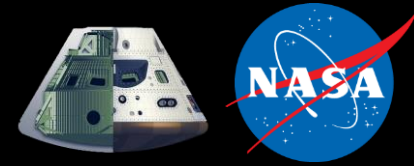

DTA1 Manufacturing & Assembly

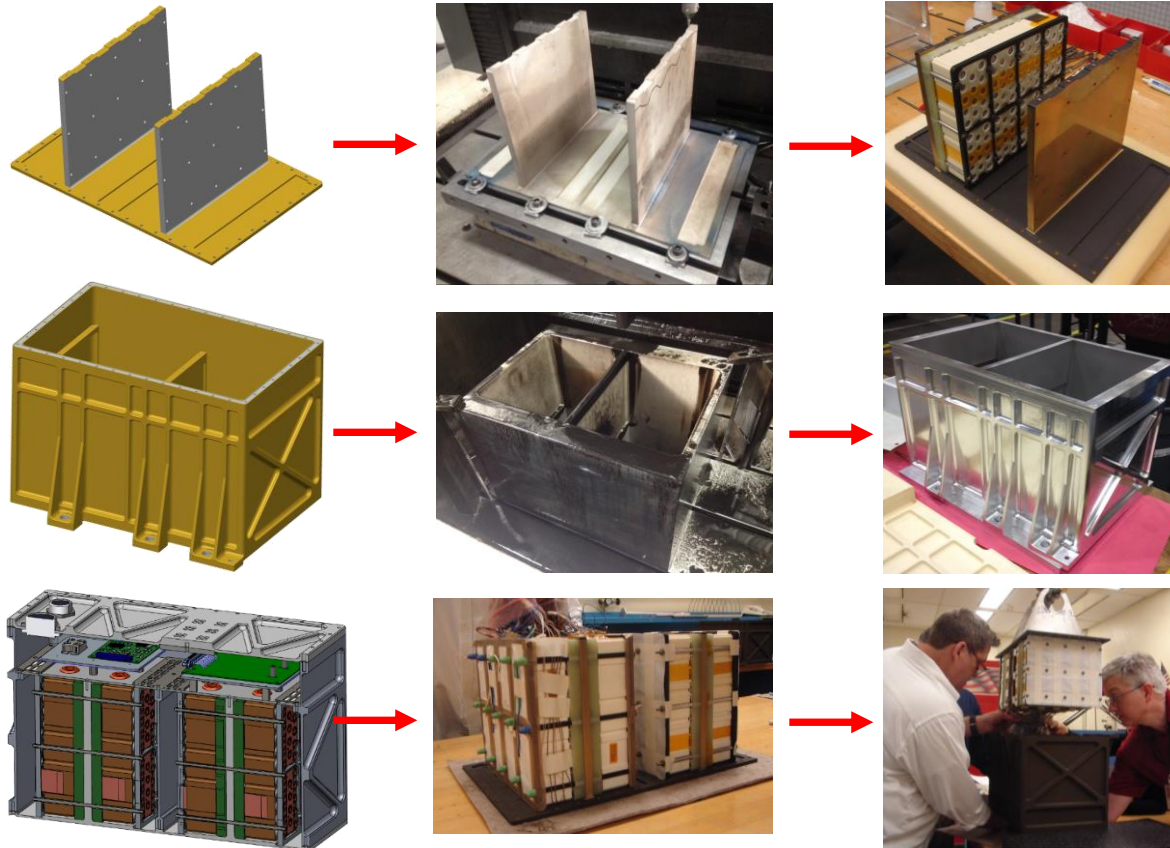
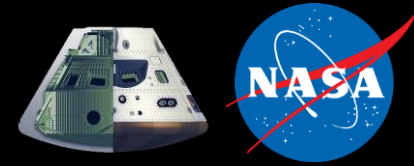

Orion Small Cell SuperBrick Heater Trigger Method

February 2016 DTA1 Full-Scale Housing TR Test

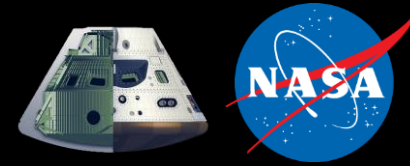

Two live 32Vdc SuperBricks along with Two emulator bricks were installed a full Scale DTA1 housing, connectors not shown but are used to transmit instrumentation signals during the test

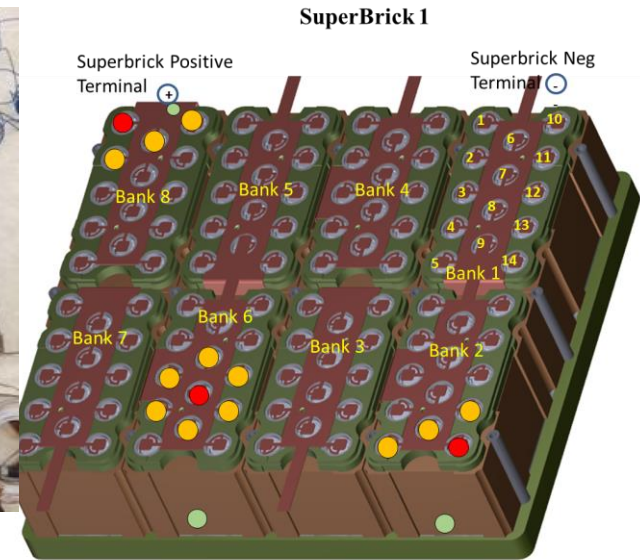
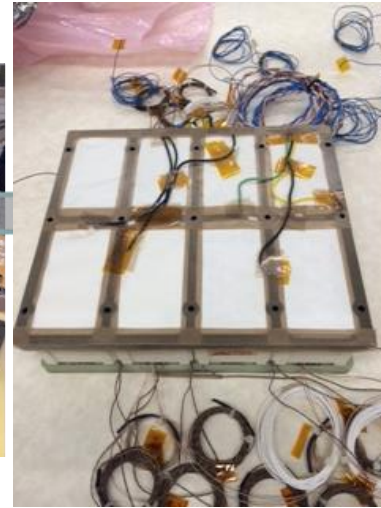
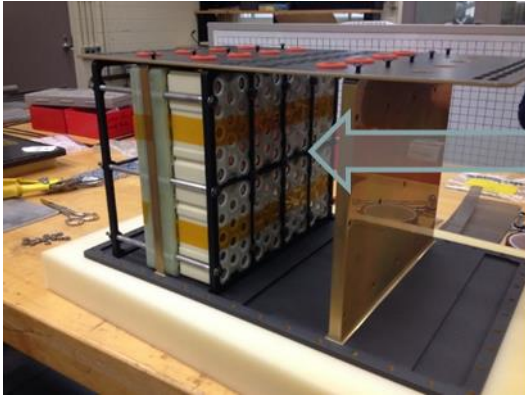

- ### SuperBrick 2
- Trigger Cell Location
 - Cell TC Location
 - TC On the Negative Capture Plate

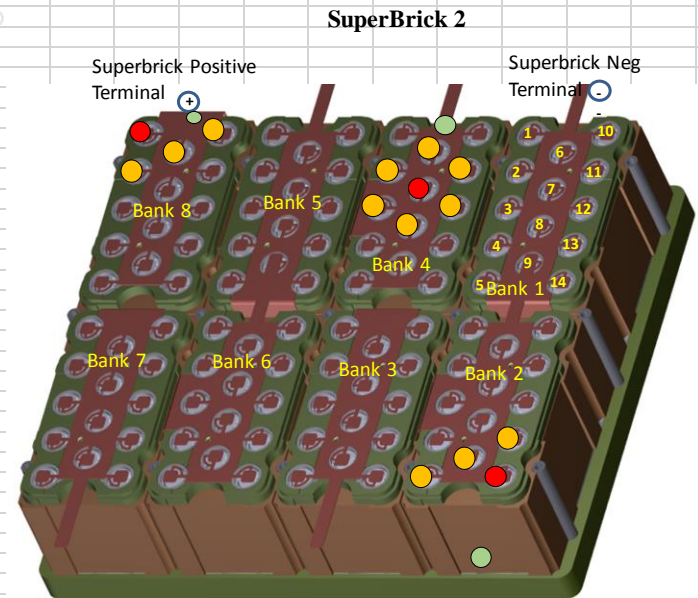

Orion Small Cell SuperBrick Heater Trigger Method February 2016 DTA1 Full-Scale Housing TR Test

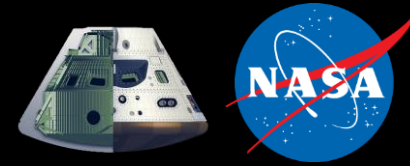

Test article installed on the cold plate in the test cell and checked out with instrumentation system

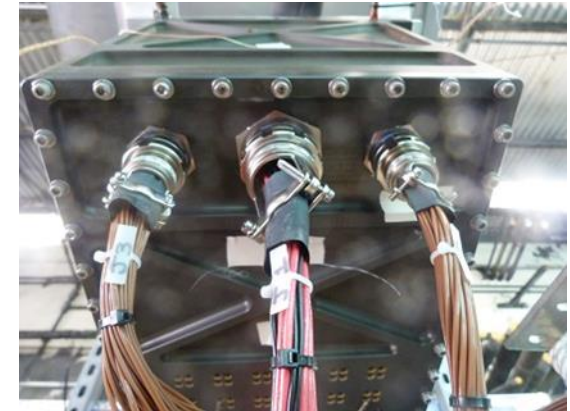

Orion Small Cell DTA 14P Sub-block Heater Triggered February 2016 DTA1 Full-Scale Housing TR Test Run 2

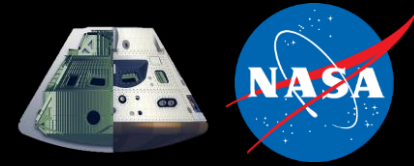

DTA1 TR Test Run 2 - Feb 10, 2016

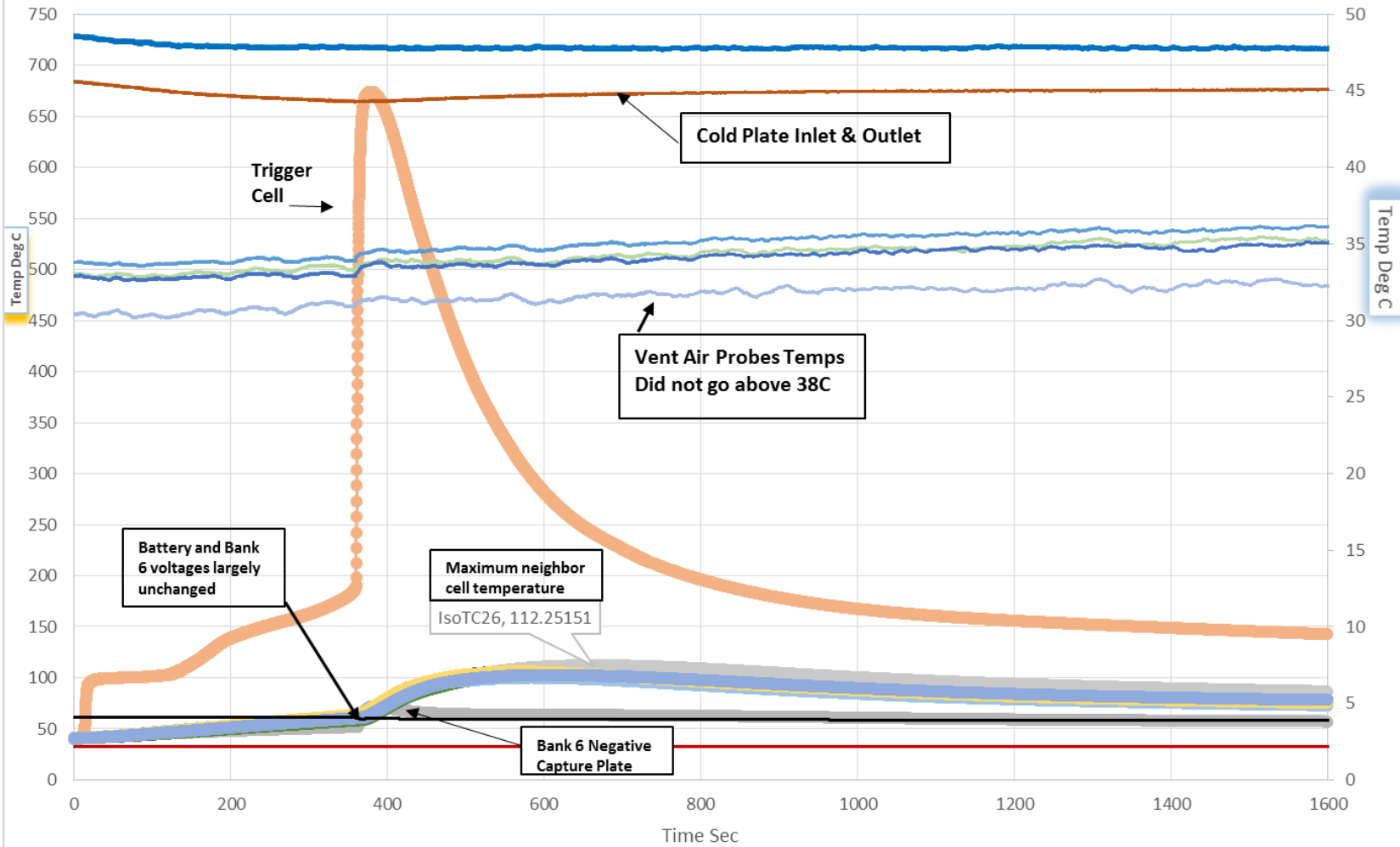

- V1
- IsoTC14
- IsoTC22
- IsoTC23
- IsoTC24
- IsoTC25
- IsoTC26
- IsoTC27
- IsoTC28
- V6
- IsoTC37
- IsoTC43
- IsoTC52
- IsoTC53
- IsoTC54
- IsoTC55

Orion Small Cell DTA 14P Sub-block Heater Triggered February 2016 DTA1 Full-Scale Housing TR Test Run 4

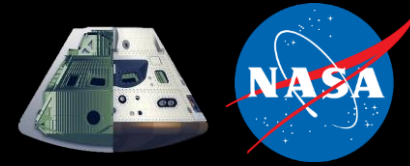

DTA1 TR Test Run 4 - Feb 11, 2016

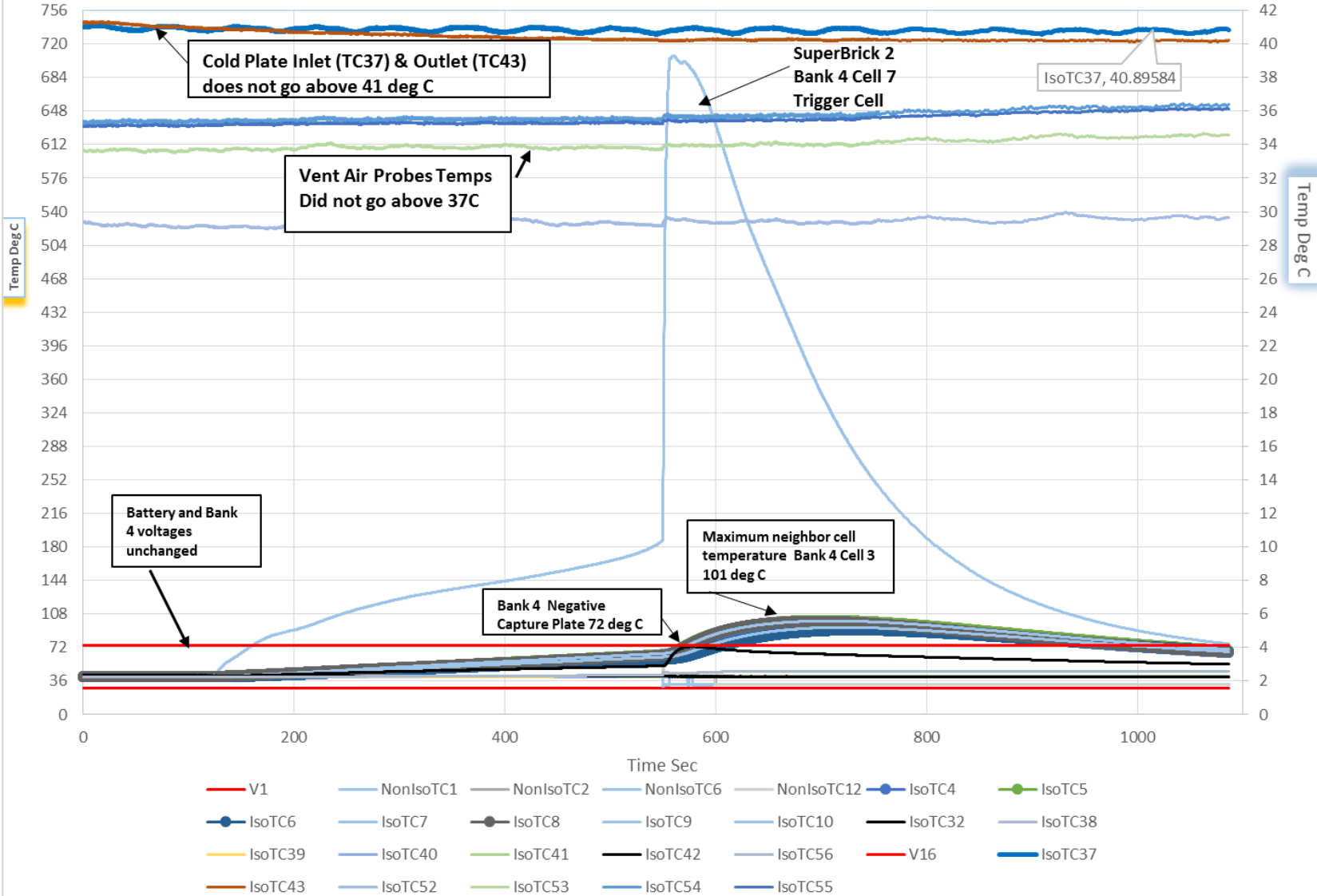

Orion Small Cell DTA_14P Sub-block Heater Triggered February 2016 DTA1 Full-Scale Housing TR Test Run 3

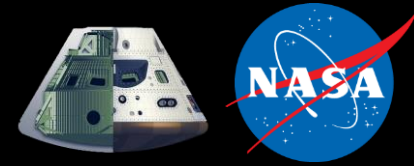

DTA1 TR Test Run 3 - Feb 10, 2016

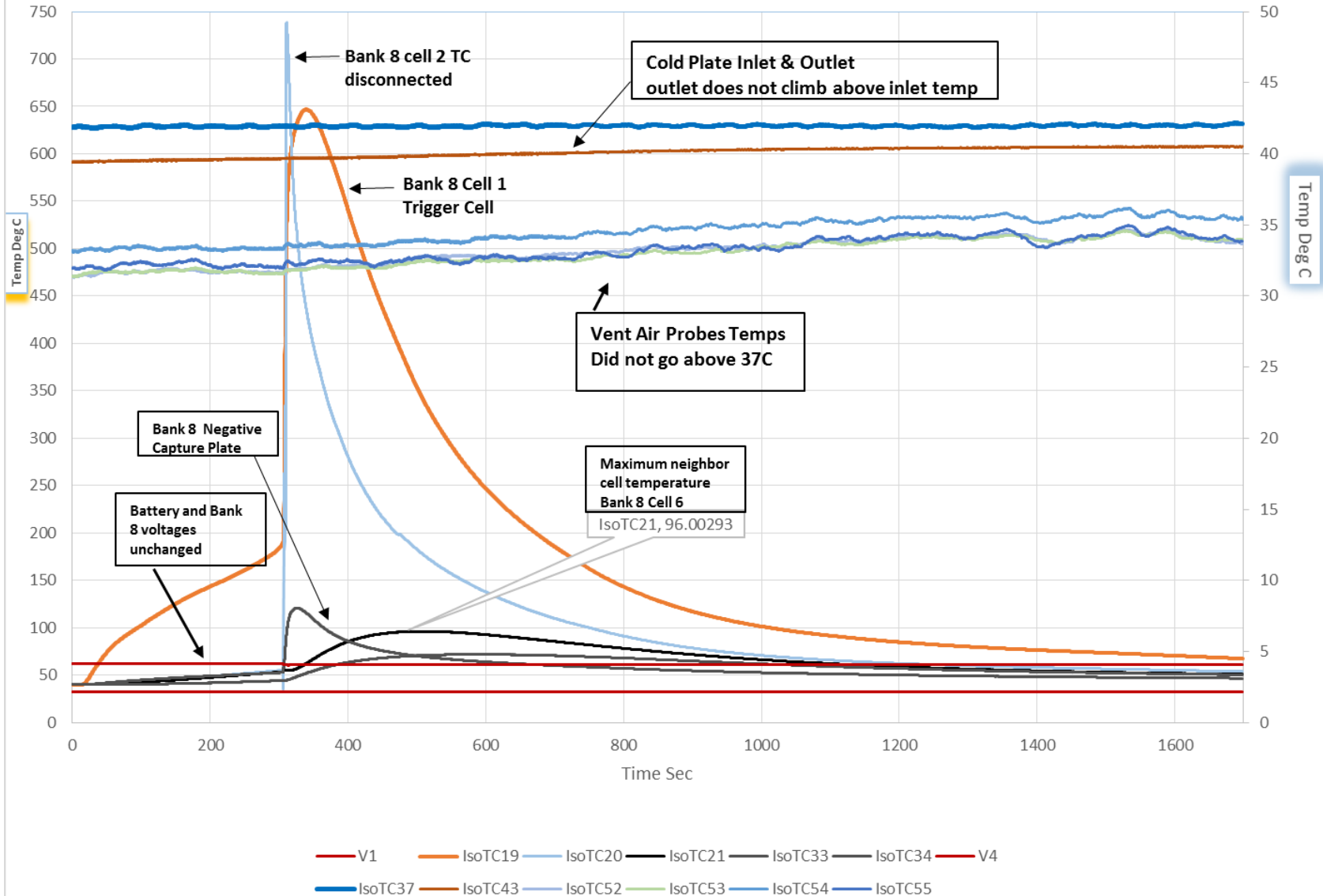

Orion Small Cell DTA_14P Sub-block Heater Triggered February 2016 DTA1 Full-Scale Housing TR Test Run 1

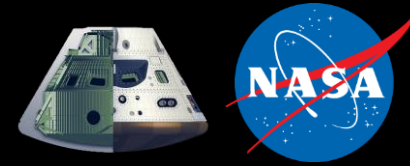

DTA1 TR Test Run 1 - Feb 9, 2016

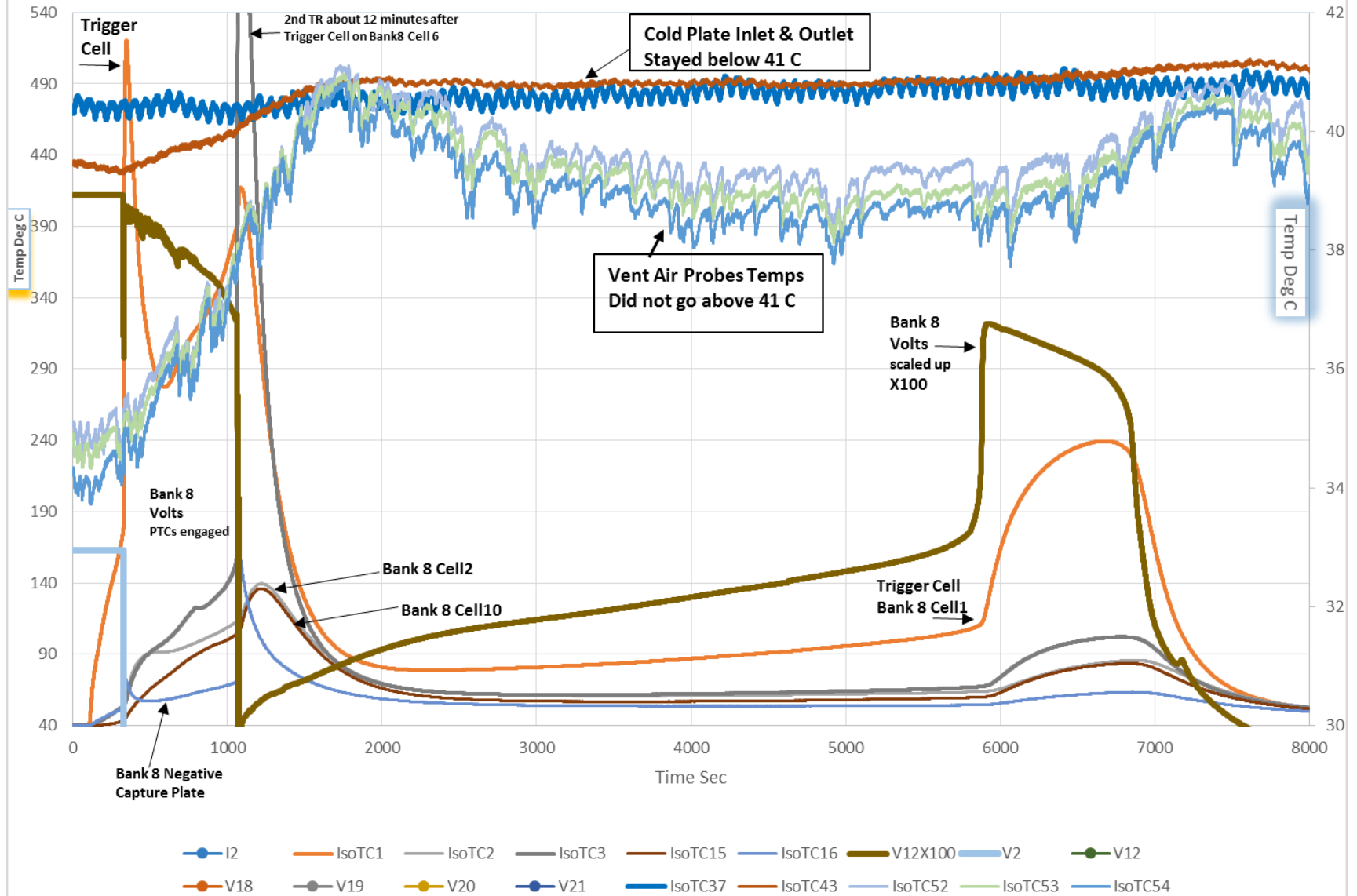

DTA1 Full-Scale Housing Pressure Profiles Pressure Transducer Data

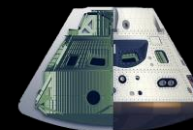

DTA1 Battery Housing Internal Pressure Data
TR Testing Feb 9-11, 2016

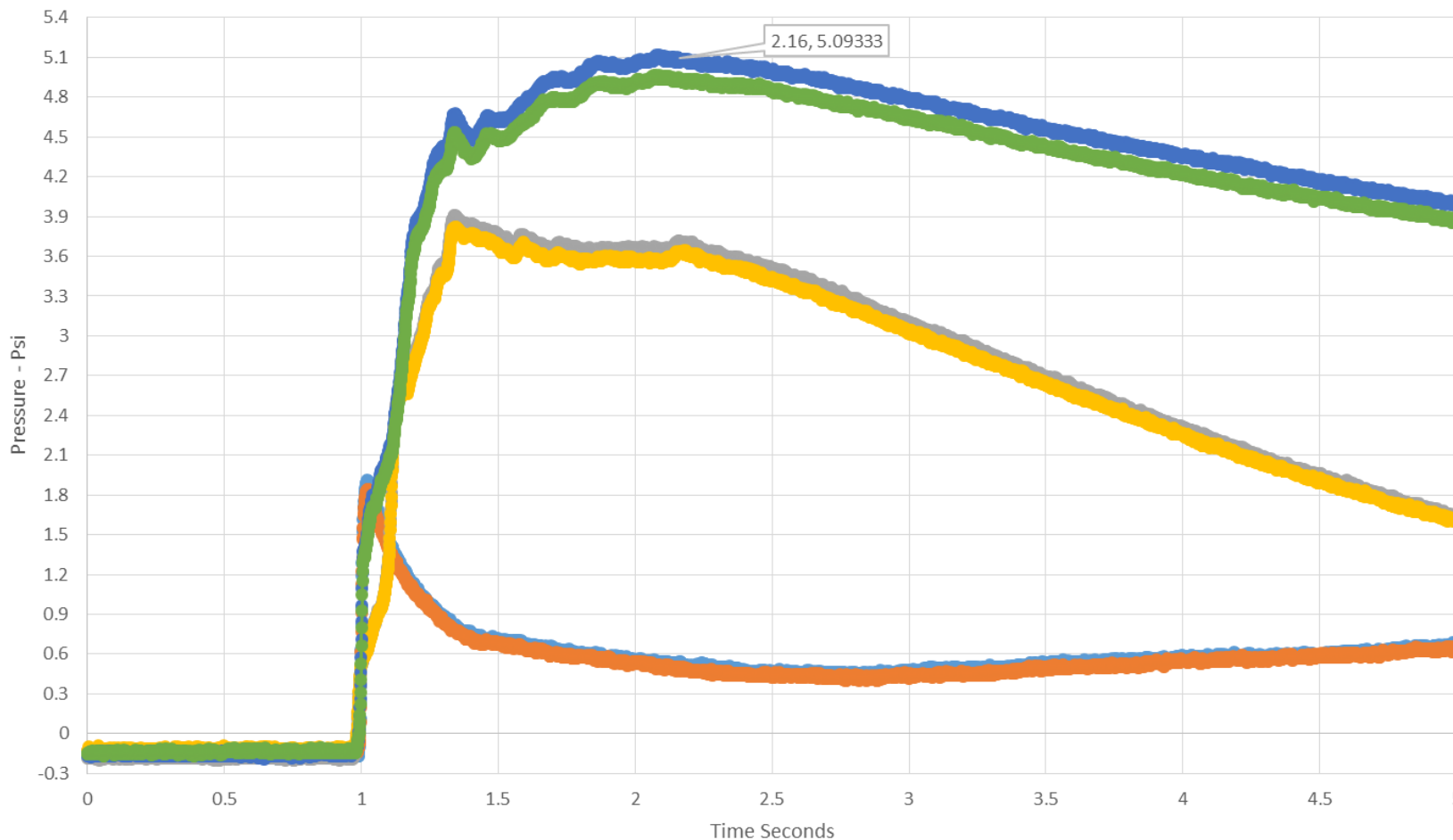

- File: C:\exports\file3b027_55w_orion_DTA1_run3_2-10-16.txt
- File: C:\exports\file3b027_55w_orion_DTA1_run3_2-10-16.txt
- File: C:\exports\file3b027_55w_orion_DTA1_run4_2-11-16.txt
- File: C:\exports\file3b027_55w_orion_DTA1_run4_2-11-16.txt
- File: C:\exports\file3b027_65w_orion_dta1_run2_2-10-16.txt
- File: C:\exports\file3b027_65w_orion_dta1_run2_2-10-16.txt

Orion Small Cell SuperBrick Heater Trigger Method

February 2016 DTA1 Full-Scale Housing TR Test

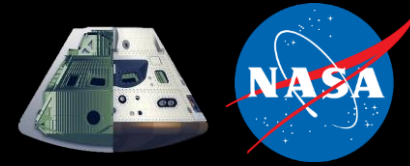

- **Successfully Completed Test Objectives - Four separate TR test runs with Full-Scale DTA1 housing with Two SuperBricks, Two SuperBrick Emulators**
 - All Tests resulted in “clean” gas with less than 6° C rise at Battery vent
 - All Tests resulted in less than 2° C temperature rise on cold-plate outlet
 - All Tests resulted in less than 6 psi pressure rise in the battery housing
 - **Test Run 1 – One neighbor cell TR, highest remaining neighbor 139° C.**
 - Ejecta shorted to bus caused prolonged additional heating, One shorted cell did experience TR after 12 minutes, remaining cells had adequate thermal margin
 - Fuse design improvement will address isolating this electrical fault
 - **Test Run 2 – No cell to cell propagation, highest neighbor cell 112° C;**
 - **Test Run 3 – No cell to cell propagation, highest neighbor cell 96° C;**
 - **Test Run 4 – No cell to cell propagation, highest neighbor cell 101° C;**

✓ Thermal Runaway events were all completely contained within the battery and demonstrated to have no impact to other spacecraft systems.

✓ Thermal Management design demonstrated control of TR propagation.

NASA Orion Small Cell DTA1 TR Post Test Photos

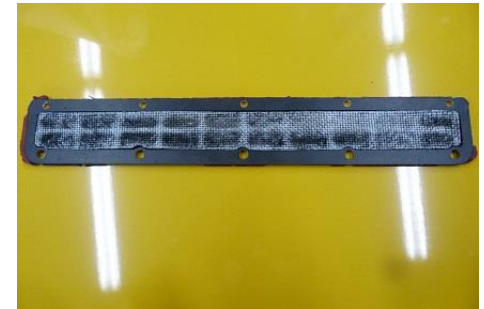
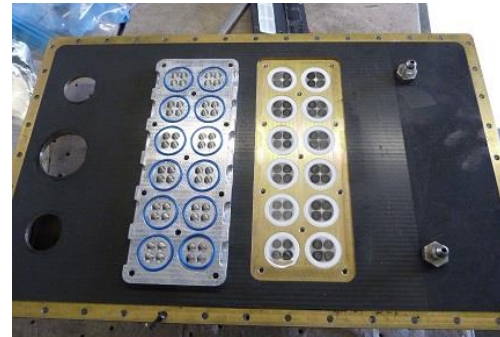
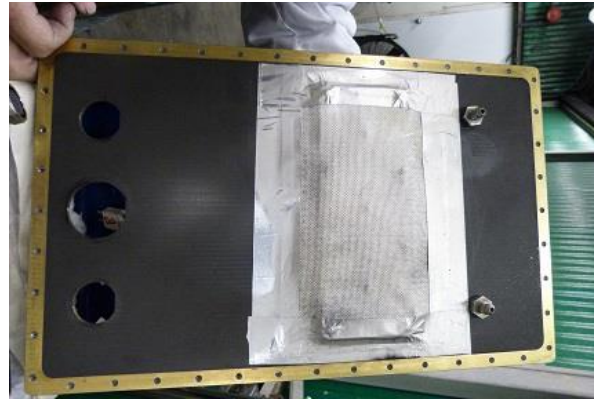
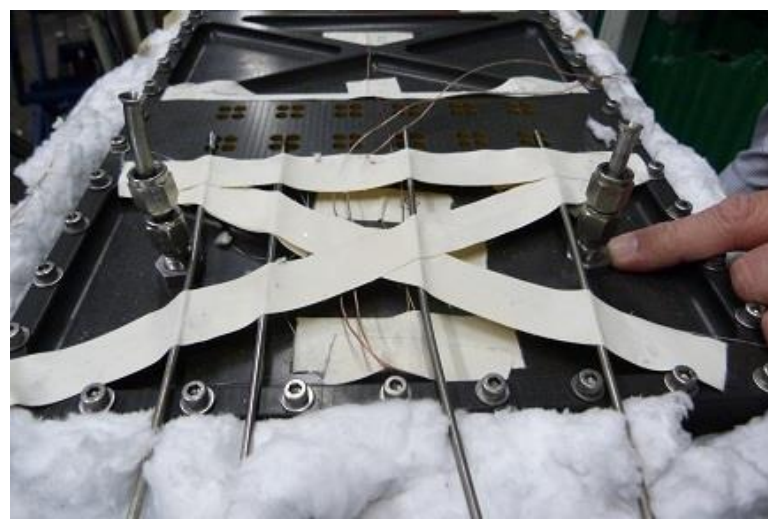
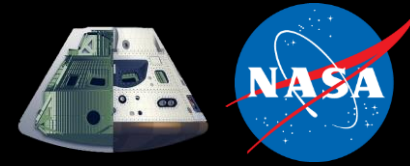

Minor collateral damage observed, particulates and flame remained internal to battery enclosure

Summary - Orion Small Cell Battery (OSCB) Development Test Article 1 (DTA1) Primary Development and Key Test Objectives Completed

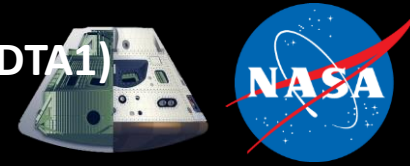

Developed and built an OSCB DTA1 full-scale test article with NESC resources supporting technical design guidance and funding test events:

- ✓ Demonstrate Structural and mechanical design and battery internal cell packaging has the ability to interface within the Spacecraft existing CM Battery mass, footprint and overall volumetric constraints in the AFT Bay
- ✓ Demonstrate Candidate Cell quality can meet established Orion EMx CM Battery CT-Scan DPA cell quality requirements for reducing the risk of FOD, defects, contamination causing a TR event
- ✓ Demonstrate electrical performance can meet power, energy and electrical impedance requirements
- ✓ Demonstrate thermal management performance has the ability to meet normal and non-normal (TR) temperature regulation requirements without impact to the ATCS cold-plate interface
- ✓ Demonstrate that vented effluent remains below explosive limits in the Aft – Bay and would be acceptable to Safety
- ✓ Demonstrate that the housing ventilation, flame and heat suppression features work to prevent flame and contain significant heat from leaving the battery housing with satisfactory pressure management
- ✓ Demonstrate the combined internal battery features for cell thermal management, physical separation, effective venting, electrical isolation and structural support work to preclude a single cell TR side wall failure from directly impinging flame onto a neighbor cell and that single cell TR will not thermally propagate to remaining cells internal to the battery

- ✓ Primary TR testing and analysis were completed and reviewed for endorsement by NASA Engineering and Safety Center team members.
- ✓ All Key Test Objects were met and a small cell design was demonstrated to be a feasible drop in replacement for the MPCV Orion CM Battery for EM2 without the need for an overboard vent.
- ✓ MPCV Orion Program Manager decision moved Crew Module Battery Baseline from the Large Cell Design to the NASA Small Cell Battery Reference Design for EM2

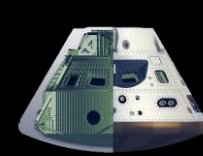

DTA2 Battery Build and Environmental Tests

- Addressed Key Technical Risk Areas (agreed by LM, JSC Engineering and NESC)
 - Shorting of Jelly Roll - to be addressed Nickel Bus Fuse Update/testing and high dielectric surface coating evaluation – Completed Design
 - Completed Design to relocate fuse to isolate on Negative of cell bank
 - Completed adding surface coating to the heat sink
 - Bus Bar protection for fuse blow isolation: Conformal coating vs Al Oxide paint, application testing In Work
 - Corner Cell Side Can Rupture - design robustness to be addressed by Improved 14P Bank Corner Cell Support and Alternative Cell Evaluation – Completed Design
 - Updated design to include thicker sleeves (9 mil to 13 mil)
 - Updates to cell bank heat sink to provide increased thermal contact at base of each cell
 - Introduced LG MJ1 as alternative cell for design with thicker can wall and lower crimped header burst pressure
- Thermal runaway regression testing of alternate cells in updated DTA2 Sub-block configuration
 - Sub-block Heat To Vent Testing.
- **Primary Risk to Address for Orion abort vibe and shock environments,**
 - **Validate Housing and SuperBrick Structural and Mechanical design by test**
 - **Validate SuperBrick Part Structural Robustness for abort vibe and shock by test**

Acknowledgements

MPCV Orion Small Cell Battery Project Team

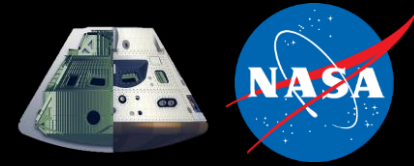

NASA JSC & GRC Project Team:

Chuck Haynes, Eric Darcy, Minh Tran, Gabriel Ortiz-Sanchez, Richard Hagen, Robert Bohot, Will Walker, Tara Sprinkle, Brad Strangways, Caleb Fisher, Tony Iannetti, Scott Hansen, Sarah Wright, Chip McCann, Ramon Lebron-Velilla, Frank Davies, Tim Fisher

NASA JSC ESTA Test Team:

Cindy Situ, Christina Deoja, Thomas Viviano, Mike Salinas, Tony Parish, Anita Thomas, Derick Lenoir, Henry Bravo, Pedro Sanchez, Aden Garza

NASA APW Hardware Program Mgmt:

Bob Ess, Gary Cox, Steve Johnson

LM APW Team participants:

Jim Martin, Dick Shaw, Dan Hall, Guy Conrad

NESC Consultants:

Chris Iannello, Rob Button, et.al.

NESC Funded Request: TI-15-01034 (Alternative Orion Small Cell Battery Design Support)