



# Making Safer Battery Packs by Mitigating and Controlling Ejecta from Lithium-ion Batteries During Thermal Runaway Using LHS Materials

November 2020



Gunnar O'Connor

Senior Product Development Engineer

Latent Heat Solutions

# Who We Are



- Latent Heat Solutions has roots back to 1990 as a part of Outlast Technologies.
  - Incorporated NASA thermal management technology into textiles.
  - Over 25 Years in the textile industry and the global leader for phase change, latent heat storage (LHS) thermal management materials.
  - Since 2012, a Subsidiary of CoorsTek Technical Ceramics, largest technical ceramics company globally.
  - In 2019, the industrial LHS® materials division renamed Latent Heat Solutions LLC to align with our growing EV and electronics business
  - Oct. 2020, LHS joined the CAVU Group family of brands



## Outlast Technologies LLC

- CoorsTek ownership
- Textile business division managed by EU
- Electronics and Industrial division managed by US



## Latent Heat Solutions LLC

- Remained under CoorsTek and renamed to LHS
- Li-ion battery, electronics and industrial businesses



## Outlast Technologies GmbH

- Divested 2019, MBO
- Textile business

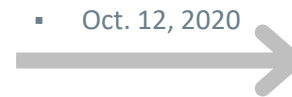

## CAVU Group

- Acquired to expand thermal management and thermal monitoring segments
- Global leader in Life Sciences, Medical Device, Pharmaceutical shipping, Industrial and now Energy Storage thermal control.

- Background of thermal runaway ejecta
- Proposed solutions
- Example Test Results
  - Testing methods
  - Test 1 - Customer A: 7 cell pack, no mitigation
  - Test 2 - Customer A: 7 cell pack, LHS material added
  - Test 3 - Customer B: 2s16p pack, LHS material added, no barrier
  - Test 4 - Customer B: 2s16p pack, LHS material added, w/ barrier
- Conclusions

- When lithium-ion cells go into thermal runaway, their temperature rapidly increases, vaporizing the electrolyte and increasing pressure until the cell vents. This venting behavior is crucial in terms of:
  - Amount of heat dissipated from the cell during failure.
  - Mechanical integrity of the cell or can.

Both have significant impact on their surroundings and are highly dependent on:

- Cell chemistry
- Cell manufacturer
- Cell arrangement/pack architecture.
- Energy and power densities

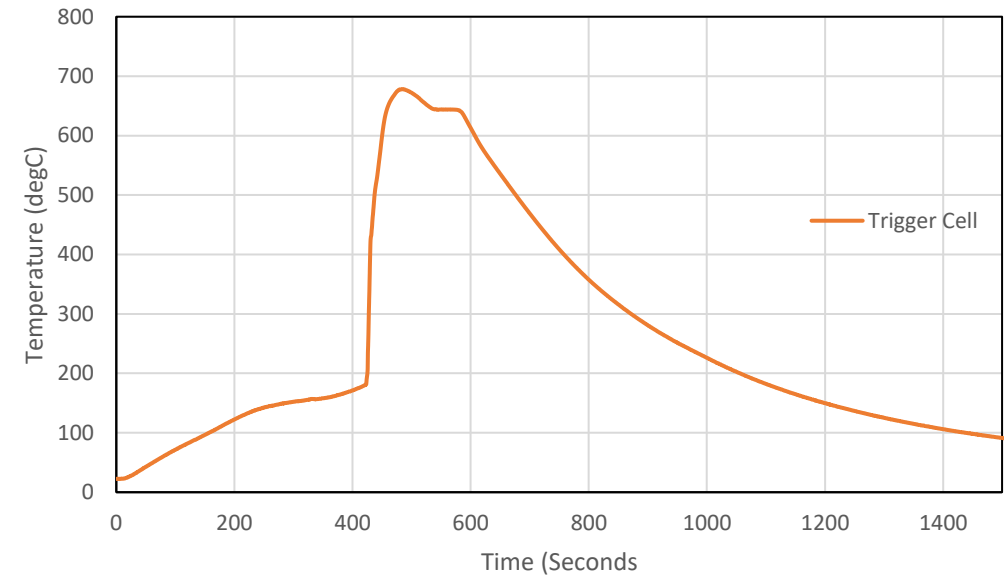

**Upward of 80% of total energy from a failure event can be released through ejecta material.**

# Background – Ejecta in Thermal Runaway



- All commercial lithium-ion cells are equipped with multiple safety devices (pressure relief, PTCs, CIDs, etc) to prevent excessive pressure through controlled venting. However, rapid rise in temperature and pressure can quickly overwhelm these resulting in:
  - A. Ejection gases and molten materials from the positive or etched rear vents.
  - B. Elongation and failure of crimp area, releasing high velocity crimp components and electrode internals.
  - C. Rupture of the can sidewalls and ejection from the side.

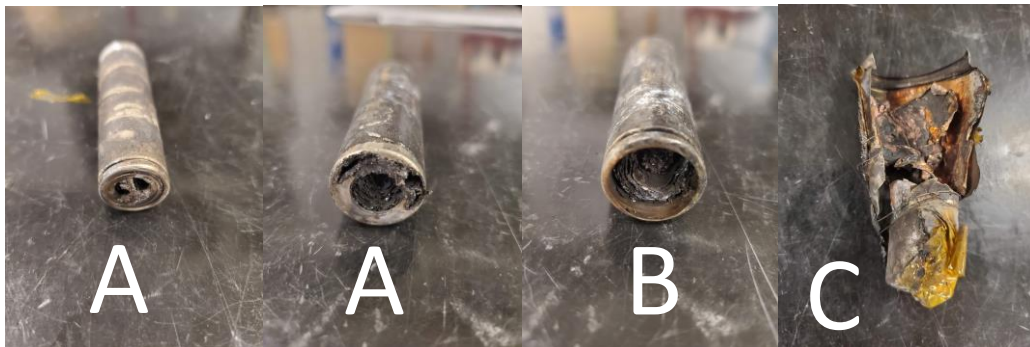

**All these scenarios can present catastrophic damage to nearby pack components, cells, etc.**

# Background – Ejecta in Thermal Runaway (cont.)



- Depending on cell chemistry, lithium-ion cells can reach upwards of 800 °C or hotter during thermal runaway.
  - Ejecta coming from these cells is very hot and pressurized, often destroying most components in its way. Most organic materials in proximity can rapidly decompose (even if UL94-V) rated), facilitating additional conflagration that adds additional heat to the system.

Every cell ejects and dissipates heat in different proportions through the positive terminal vents, negative terminal, and cell body. To the right is the breakdown of all results of an LG 18650 MJ1.

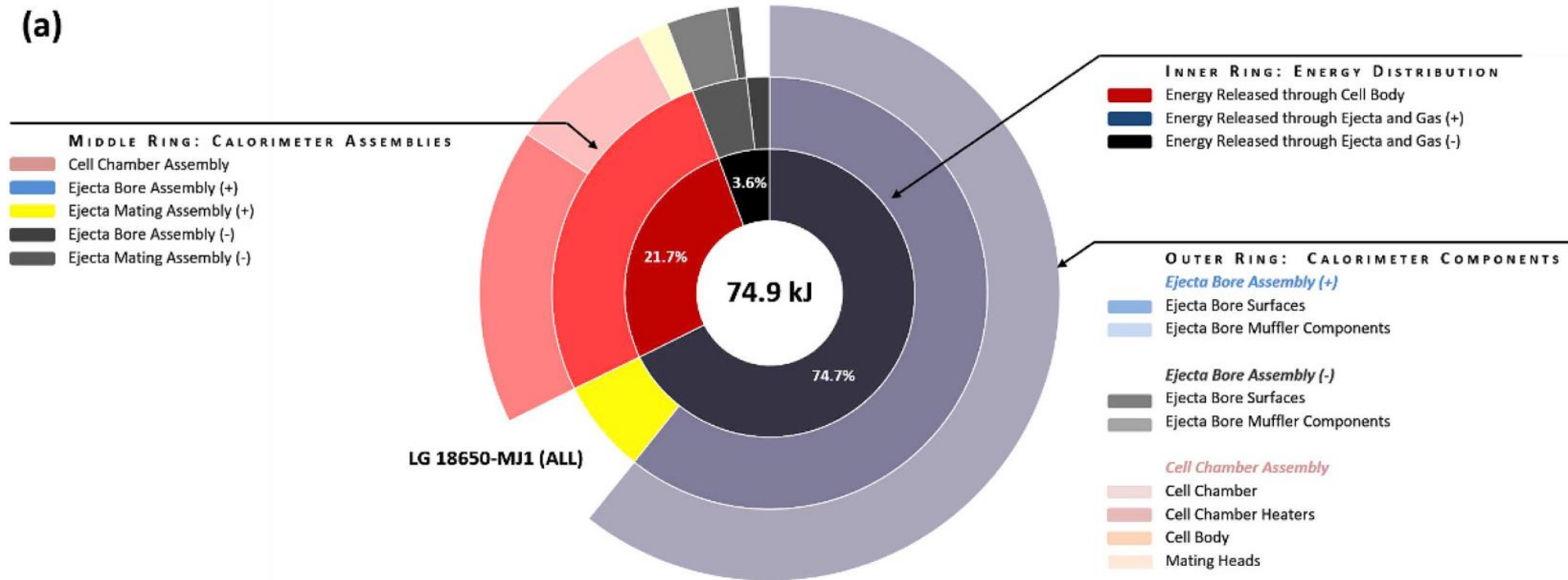

Walker, W. Q., Darst, J. J., Finegan, D. P., Bayles, G. A., Johnson, K. L., Darcy, E. C., & Rickman, S. L. (2019). Decoupling of heat generated from ejected and non-ejected contents of 18650-format lithium-ion cells using statistical methods. *Journal of Power Sources*, 415, 207-218. doi:10.1016/j.jpowsour.2018.10.099

- Capturing and converting thermal energy
  - Place high latent heat materials (phase change materials; PCM) at venting points
  - PCM material vaporizes into non-combustible vapor that absorbs substantial amounts of thermal energy.
- Quenching and extinguishing flaming
  - Non-combustible vapor/gas limits oxygen availability in enclosed pack space.
- Blocking or deflecting ejecta particles
  - This becomes important when side rupture and ejection into an adjacent pack are a risk.
  - Any material capable of withstanding extreme temperatures for a short period of time can be used, such as:
    - Metal sheet (aluminum, steel)
    - Ceramic plates
    - Some thermoplastics or thermoset composites, ideally fire retardant to potentially limit further flaming
  - Can be used to boost efficiency of organic heat sink to capture/convert ejecta thermal energy.

# Proposed Solution cont.



- LHS' solution is the XTS product
  - This product is a PCM gel that has an extremely high latent heat of upwards of 2000 J/g
    - Gel vaporizes to release non-combustible gases to quench flame
  - The gel is contained within an aluminized pouch to contain the material.
  - When thermal runaway occurs, the pouch ruptures, allowing gel to vaporize.
- LHS recommends a range of solutions to deflect/control ejecta
  - Our XTS SC1 product is a plastic PCM matrix that contains side ruptures.
    - This is only effective when used with the XTS pouches.
  - LHS may also recommend the use of additional barrier materials in front of or between cells to aid with in control.

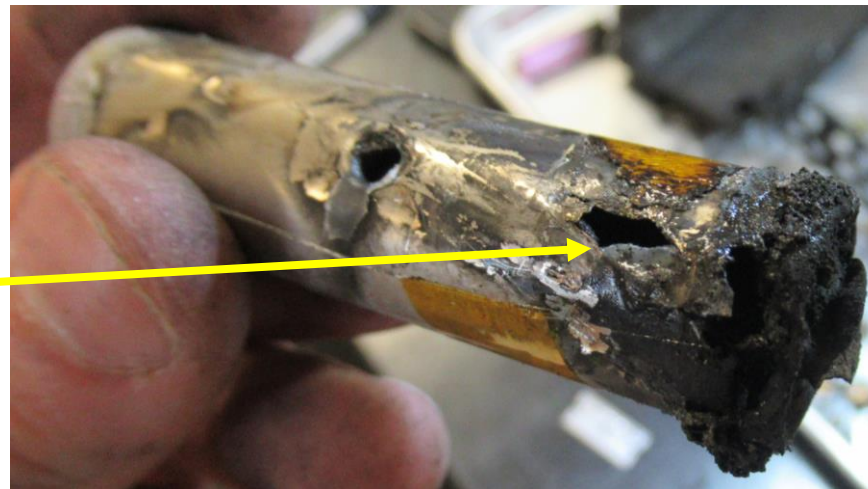
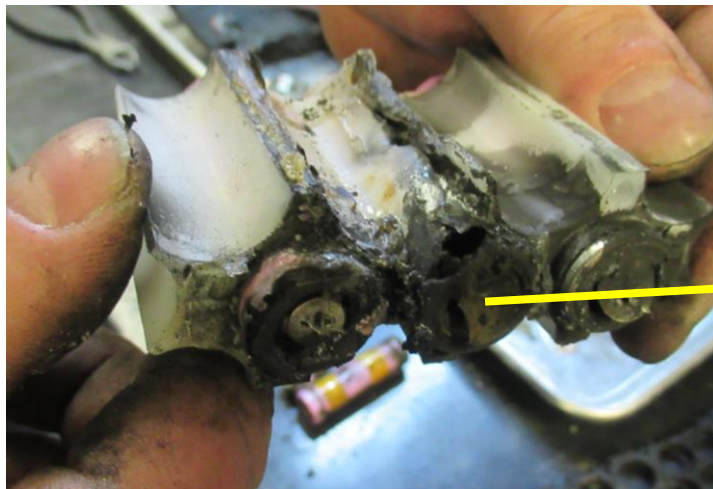





# Testing Methodology

---

- Most of our testing is solution oriented, implementing our products and design recommendations to get to a pack that prevents thermal propagation in numerous commercial applications.
- All tests include:
  - Omega K-type thermocouples attached to the trigger cell, surrounding cells, and other additional components
  - Tests initiated per customer request: hot-wire (5-10 °C/min), nail penetration (8 cm/s), or overcharge (less common).
  - Tests safely performed in ventilated fire-proof chamber behind multi-level plexiglass barrier.
  - One camera recording inside chamber; one camera recording outside chamber.
  - Extensive test setup and post-test destructive physical analysis reporting .

# Example Test 1

This is a control test, using a representative cell configuration used in a larger pack design. The enclosure and matrix surrounding the cells is made of an FR glass fiber composite (Garolite G10)

Test parameters:

- 7 cells, center cell is trigger cell
  - Samsung INR21700-50E cells
- Hot-wire initiated
- Thermocouples on sides and negative terminals
- FR composite parts
- PCB located in front of positive terminals

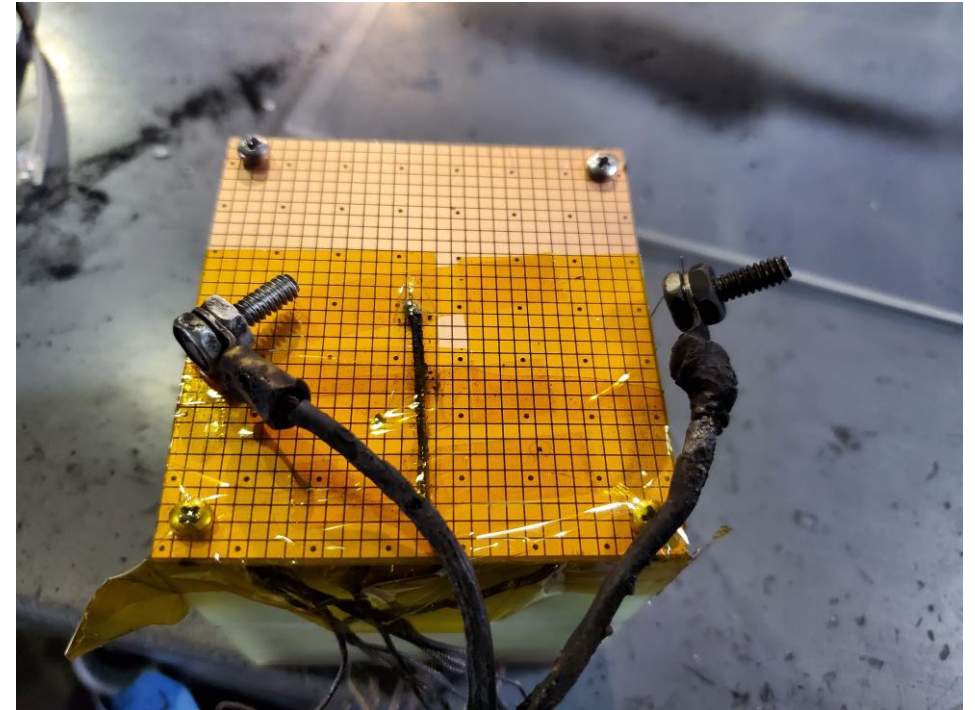

# Example Test 1 - Results



### Test 1.4 Cell Centers

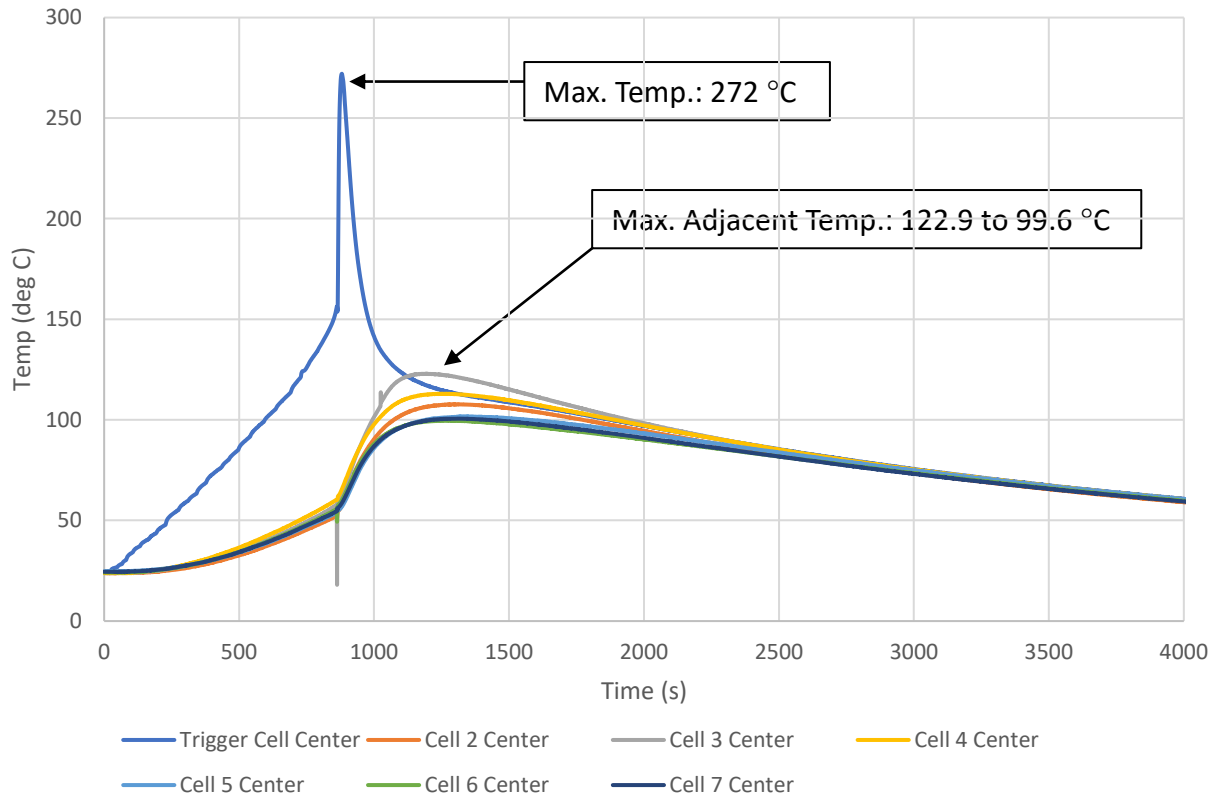

### Test 1.4 Cell Positive Terminals

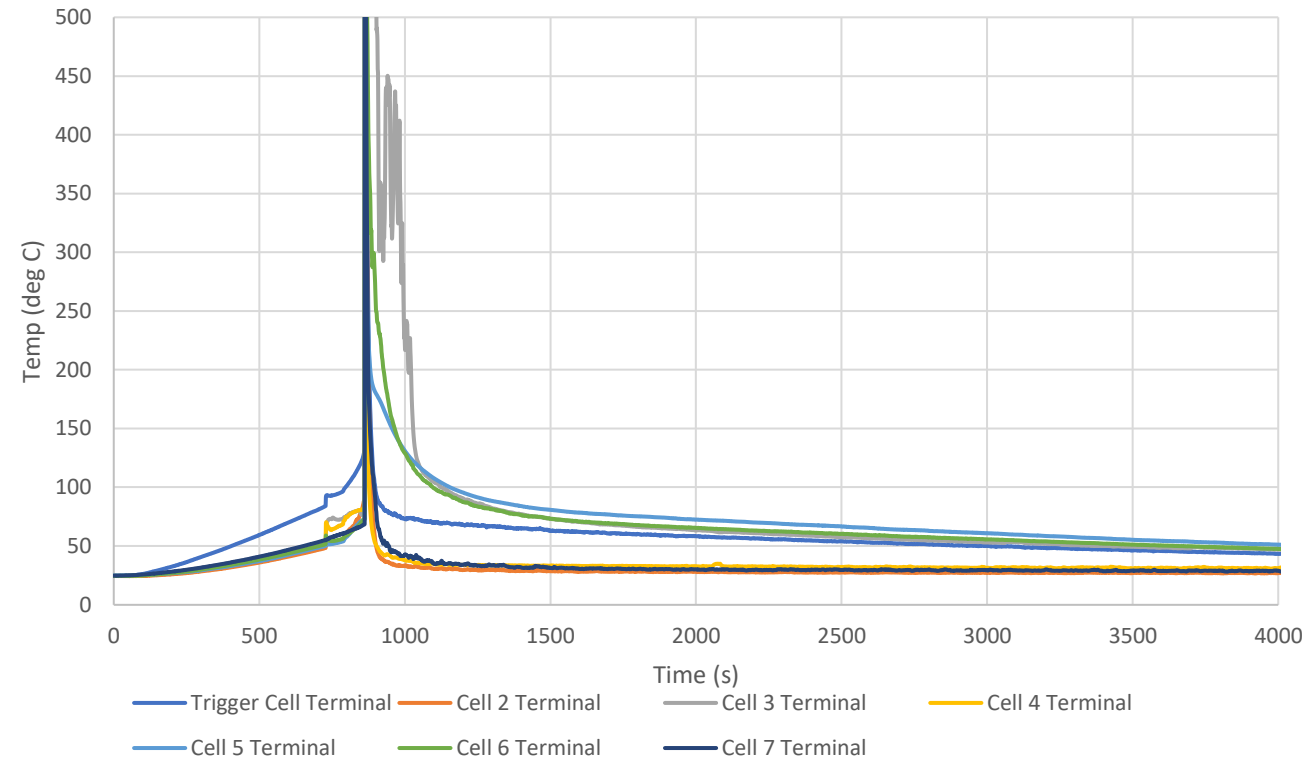

No cell went adjacent cell went to T.R., but temperatures reached dangerous levels.

# Example Test 1 - Results



Ejecta was reflected onto adjacent cells with none of the thermal energy captured, causing significant temperature increases and risk of T.R.

# Example Test 2

This is the same as test 1 except with a XTS pouch in front of the positive terminals. The enclosure and matrix surrounding the cells is made of an FR glass fiber composite (Garolite G10).

Test parameters:

- 7 cells, center cell is trigger cell
  - Samsung INR21700-50E cells
- Hot-wire initiated
- Thermocouples on sides and negative terminals
- FR composite parts
- Pouch located in front of positive terminals
- PCB secured in front of pouch, sandwiching it

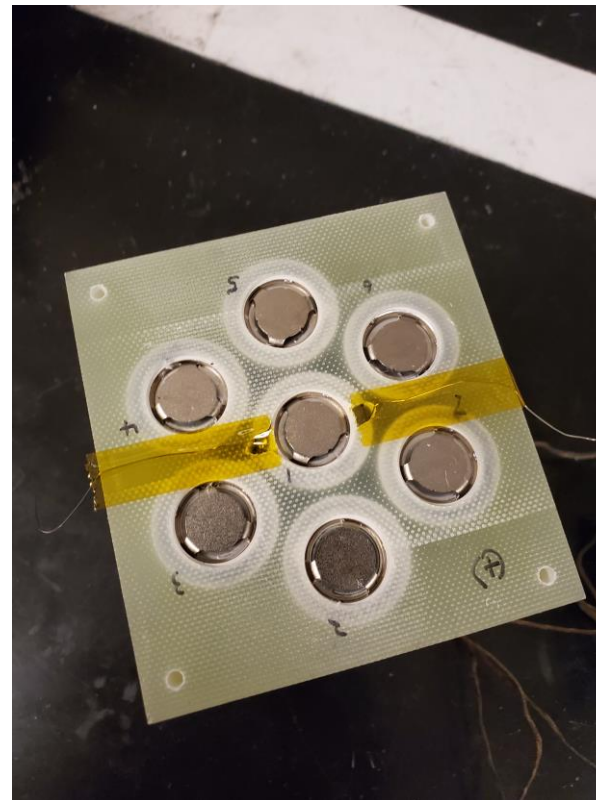
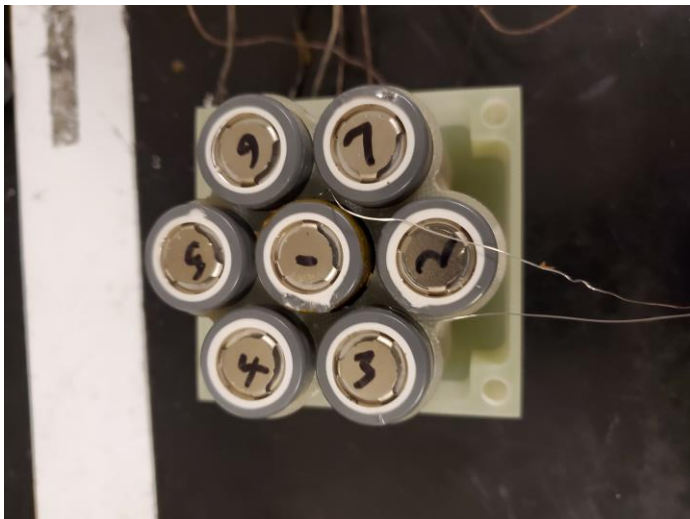

# Example Test 2 - Results



### Test 2 Side of Can Temperatures

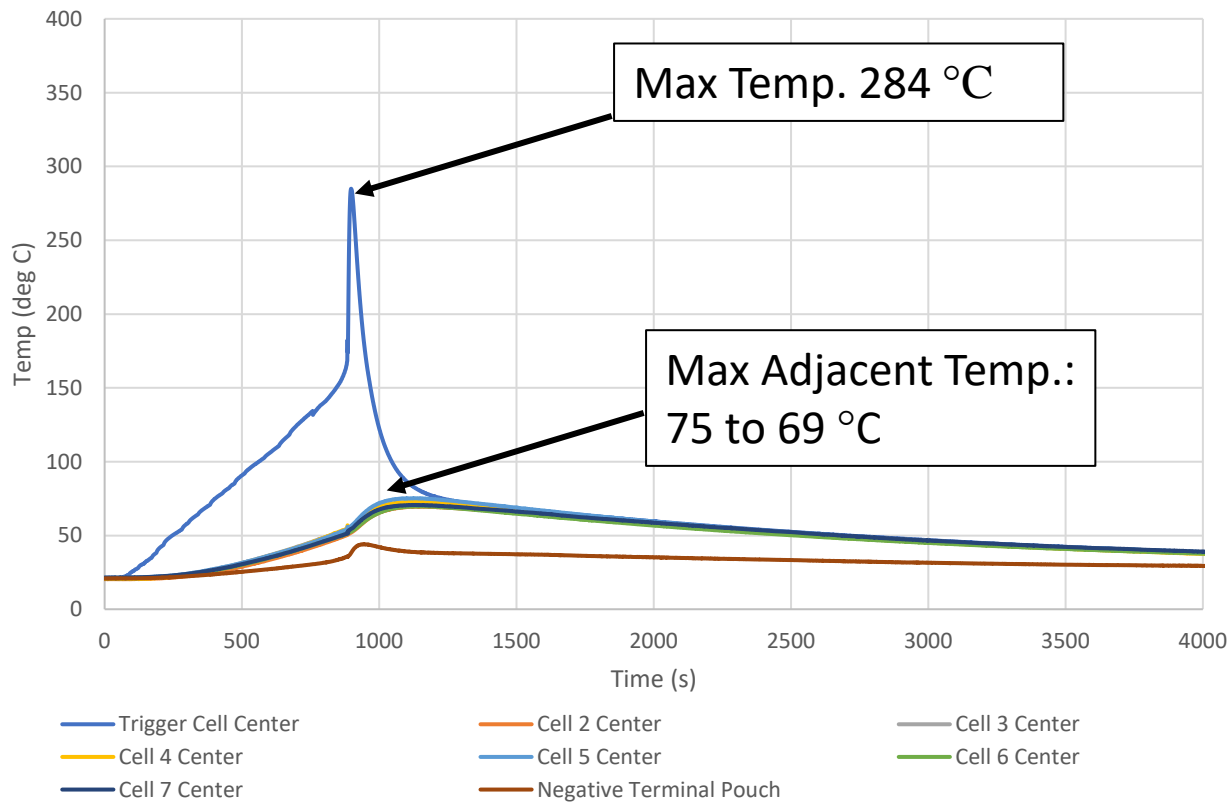

### Test 1.3 Cell Positive Terminals

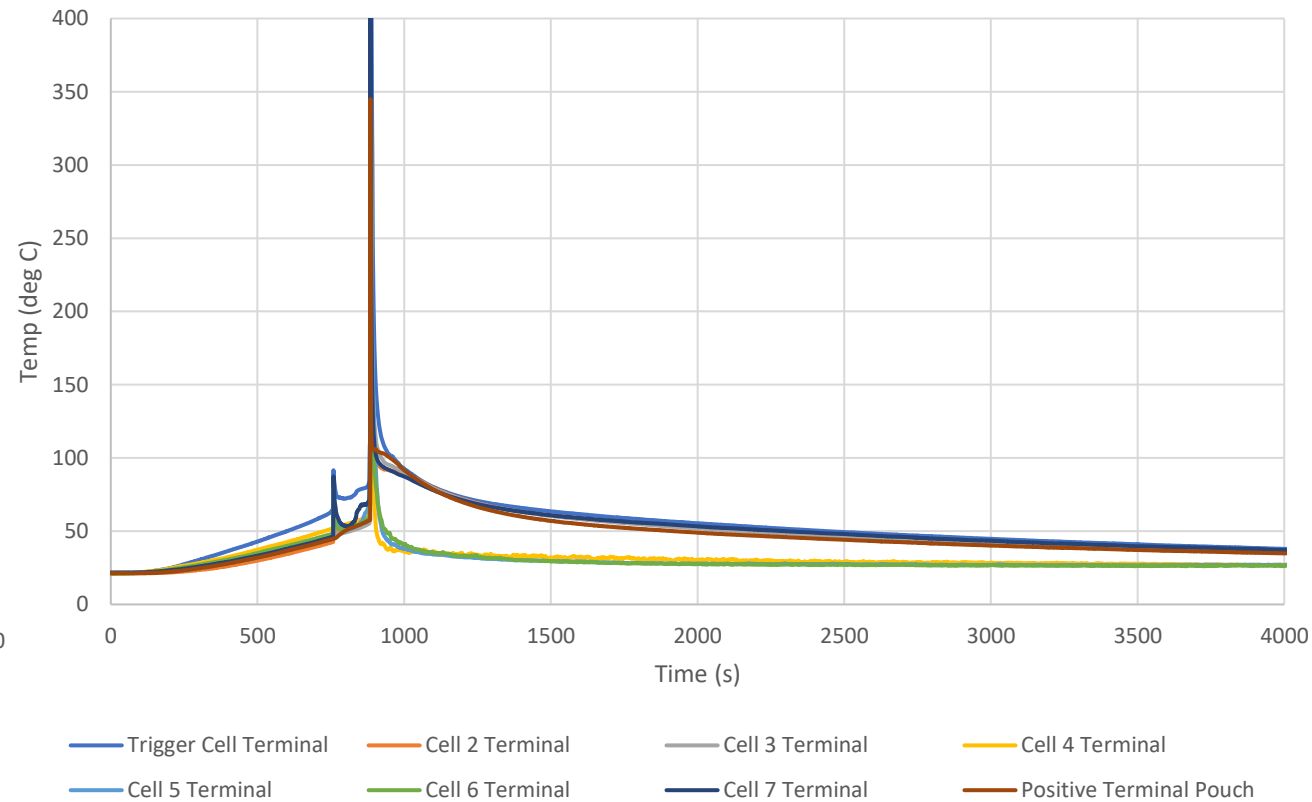

When the ejecta heat is captured, adjacent cell temperatures are below 100 C despite the trigger cell reaching the same temperature.

# Example Test 2 – Results Comparison



### Test 1 Side of Can Temperatures

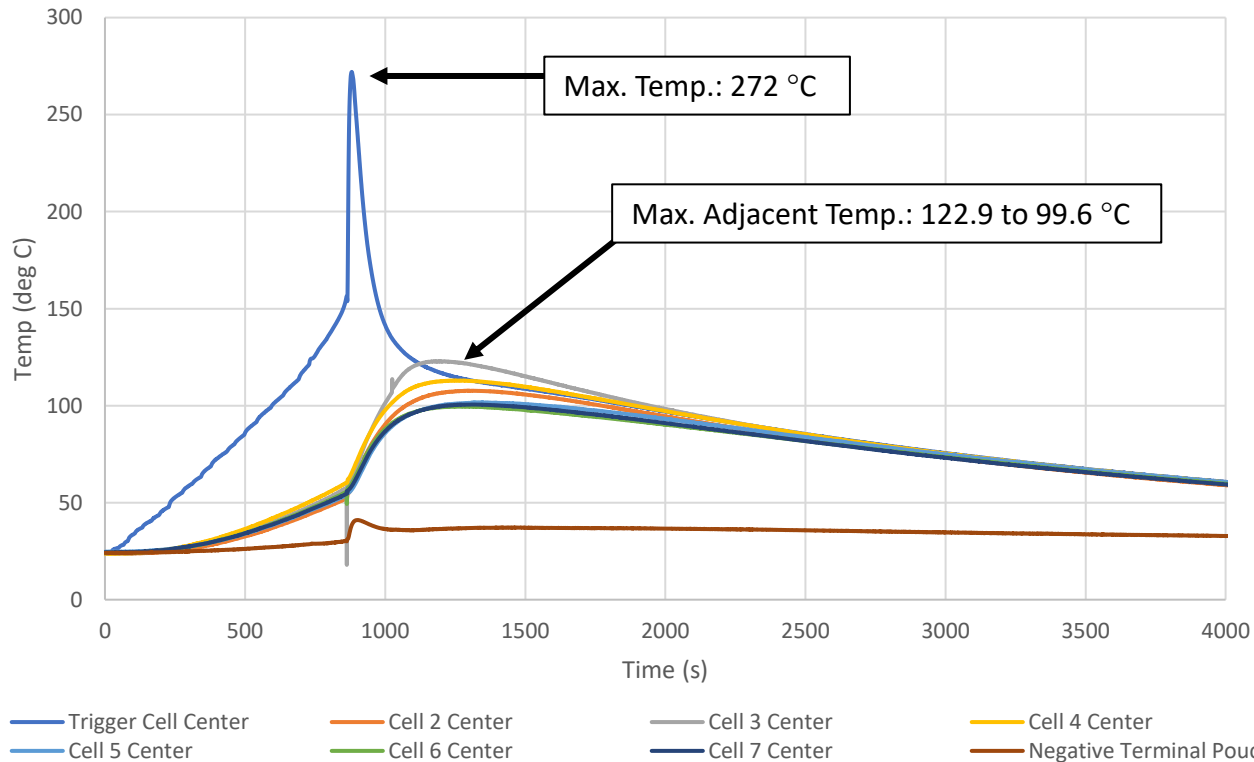

### Test 2 Side of Can Temperatures

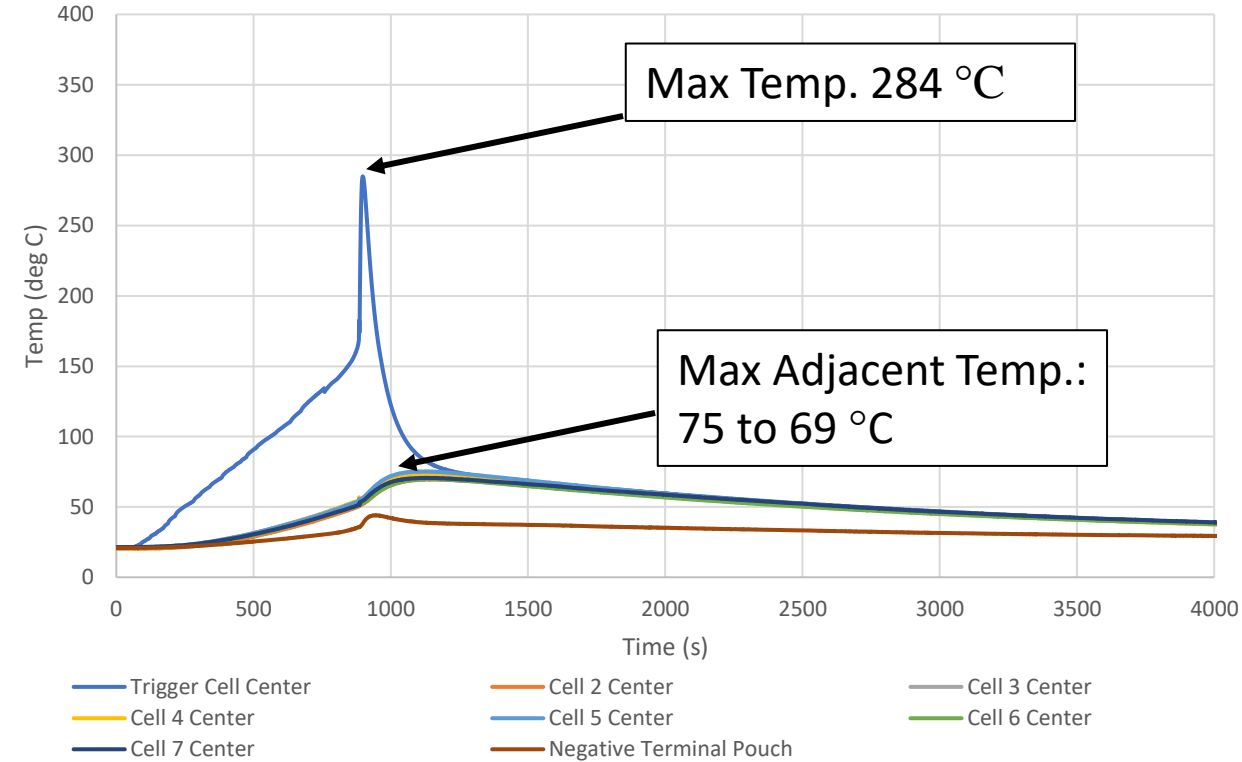

The use of XTS to absorb the heat and quench the flaming resulted in max adjacent cell temperatures 48 C lower than the test without XTS. This is because the heat was captured with a liquid to vapor phase change.

# Example Test 2 - Results

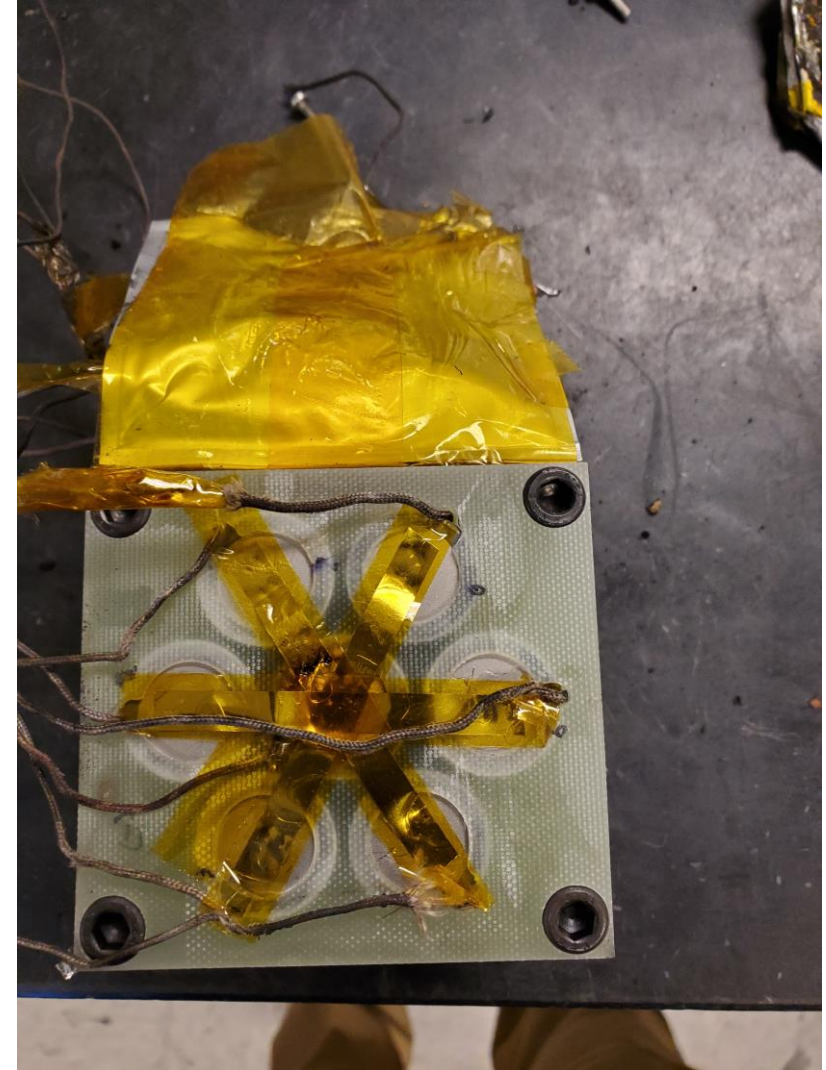
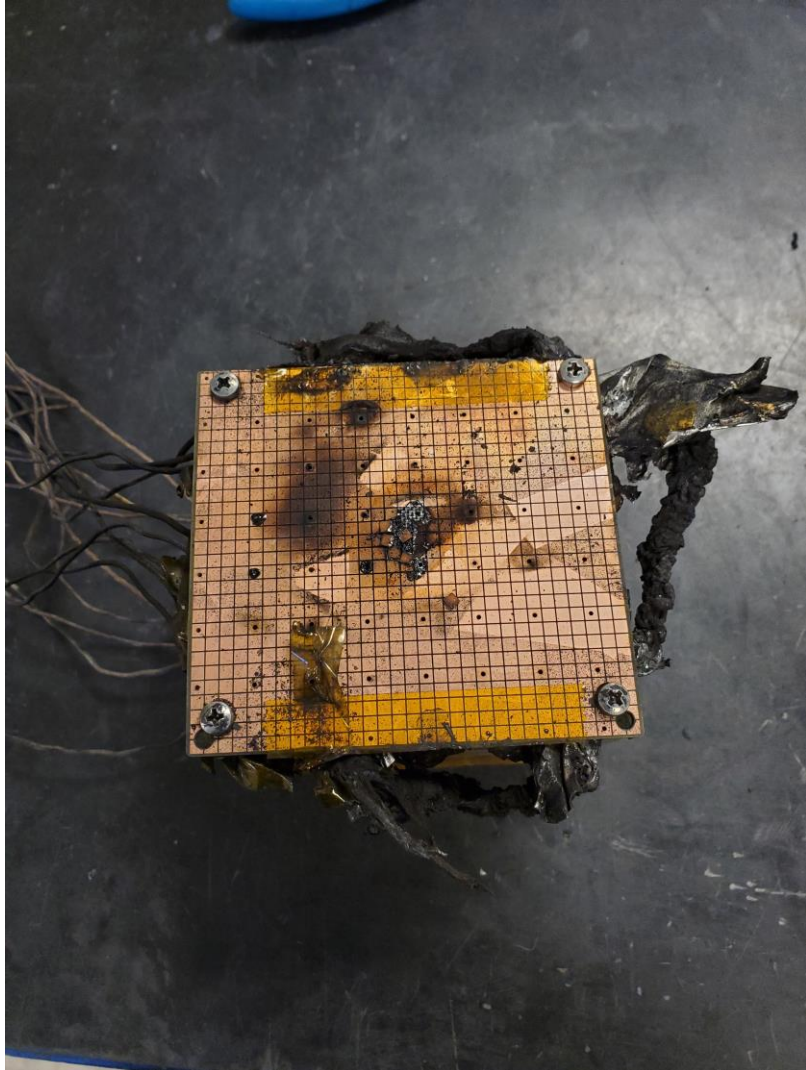



# Example Test 3

This test was performed for a different customer and is a larger format module

Test parameters:

- 2S16P LG MH1 18650
- Pouches surrounding all sides
- Thermocouples on 6 cells on each module
- Experimenting with Insulfrax between cells; no rigid barriers.
- Large amount of headspace requested by customer.

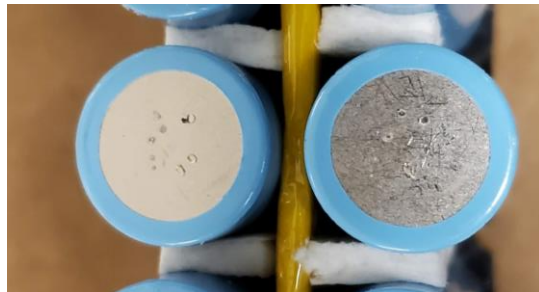
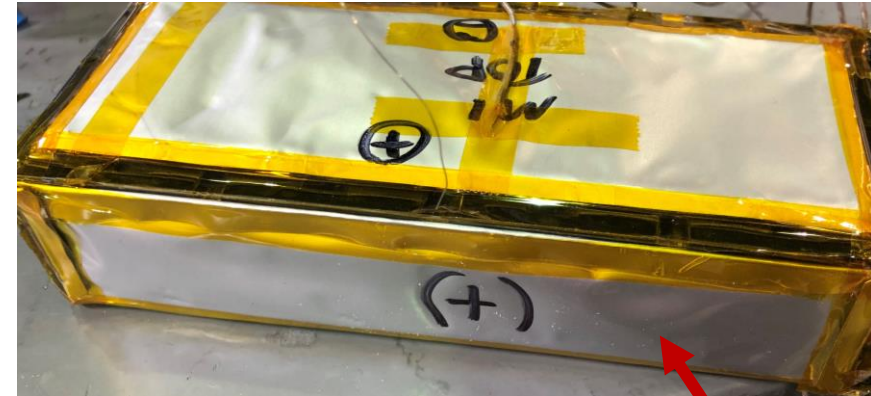

**Insulfrax barriers for side rupture/thermal insulation**



**XTS Terminal pouches placed on positive end of battery module to minimize impact on:**

- **Adjacent cells**
- **Adjacent module**

# Example Test 3

A sheet metal housing was used and secured in a  $\frac{3}{4}$ " aluminum box to contain it.

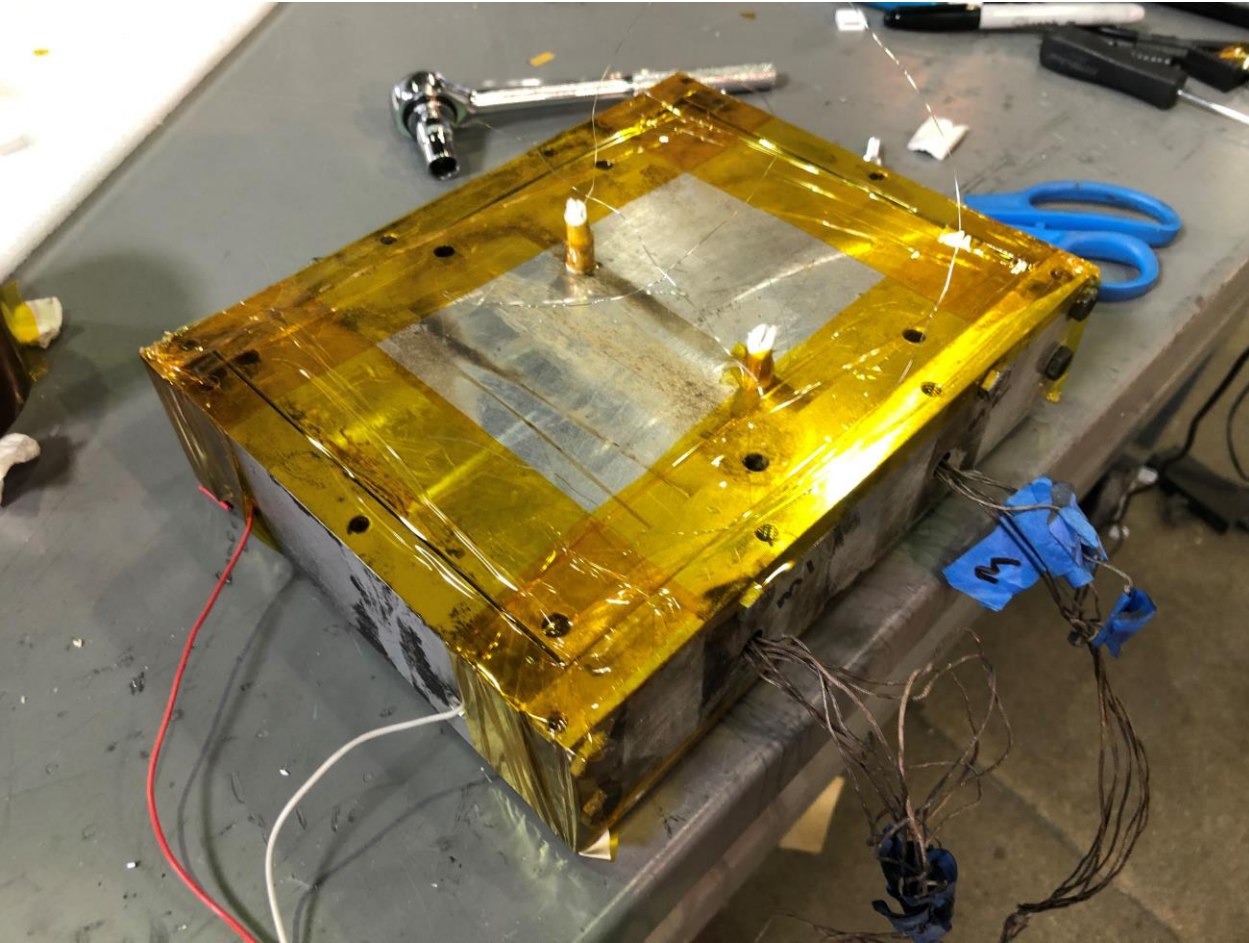
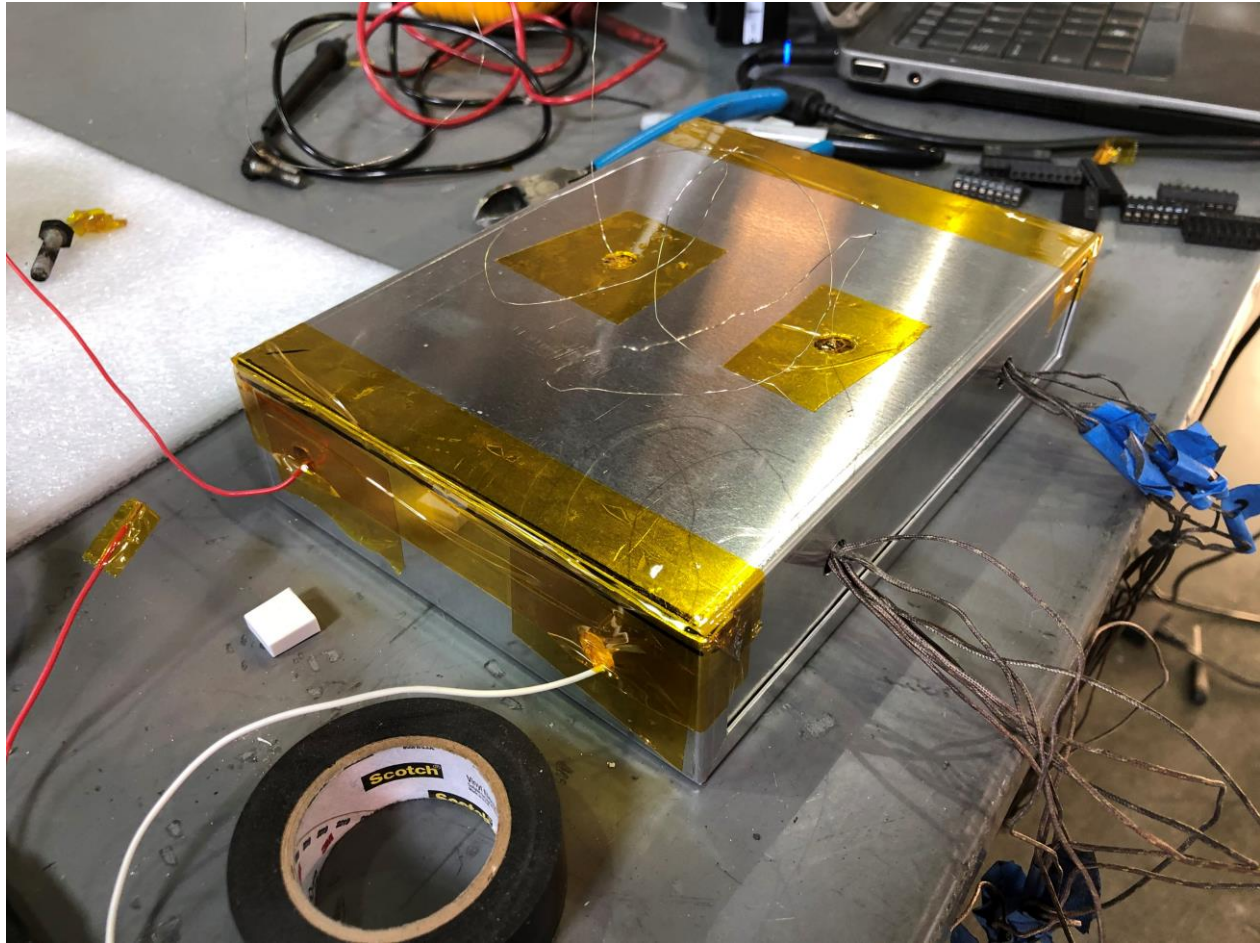

# Example Test 3 - Results



### Test 3 Module 1 Temperatures and Voltage

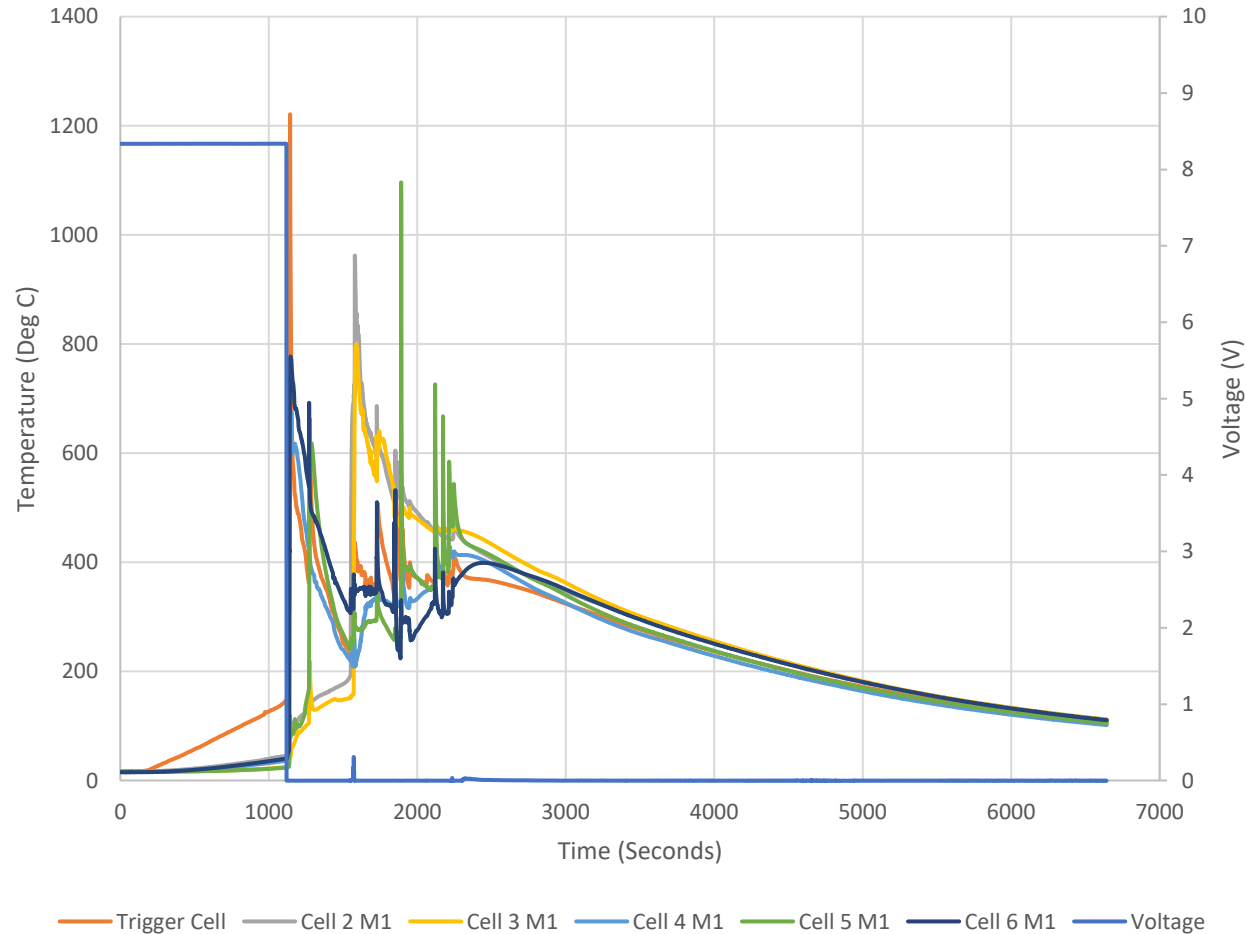

### Test 3 Module 2 Temperatures

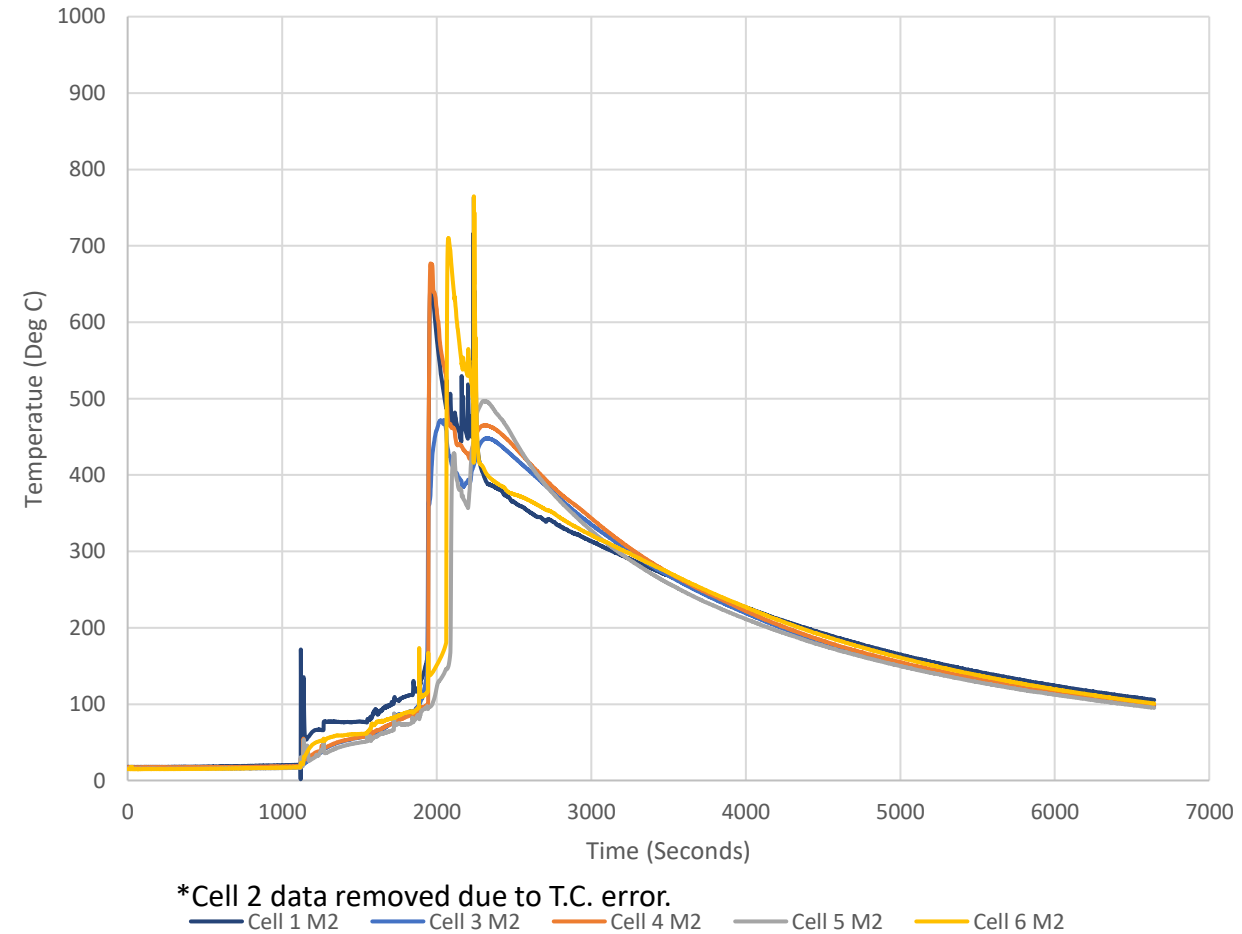

Complete thermal runaway of all cells occurred because there was no barrier material to deflect ejecta from hitting other cells and the other module.

# Example Test 3 - Results

Total loss of pack due to no ejecta mitigation.



Extensive side-rupturing was observed in nearly every cell. Insulfrax is insufficient in protecting against this cell-to-cell propagation. Trigger cell marked.



# Example Test 4

This test was similar in format to test 3 with stainless steel dividers and a new housing with vent relief ports:

- LG MH1 18650
- Pouches surrounding all sides
- Thermocouples on 6 cells on each module
- Placed stainless steel between each set of 2 cells. Another larger piece placed between the two modules.
  - S.S. pieces are electrically and thermally insulated w/ insulfrax and Kapton.

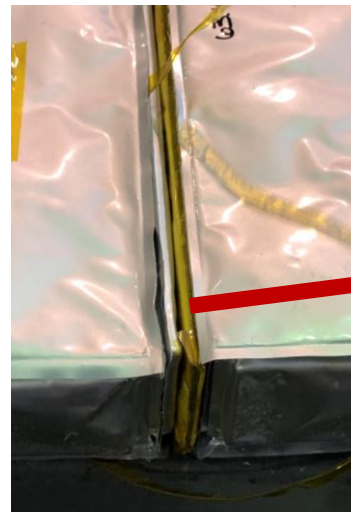
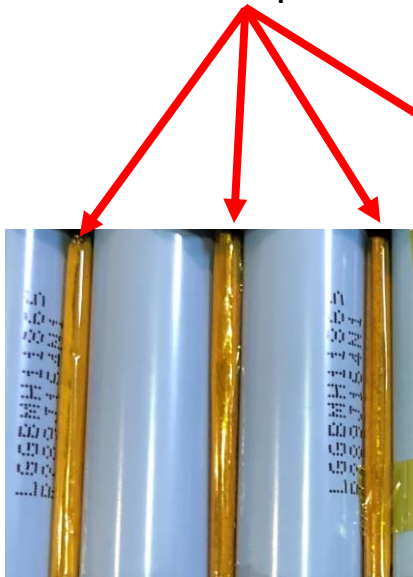

SS insert between XTS pouches

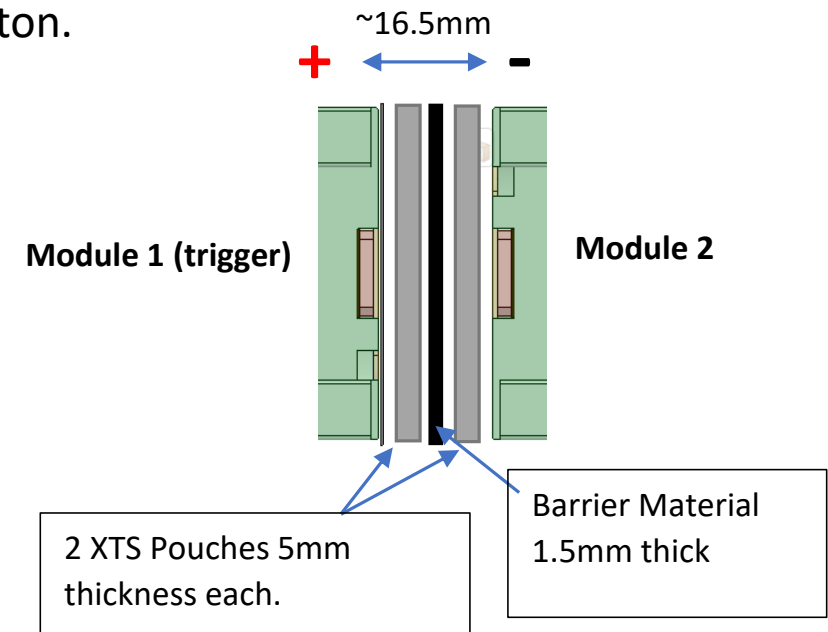

# Example Test 4

Per customer request, a similar housing was selected, and vent ports were cut, and packs were secured down.

This was done to prevent explosive rupture of the housing during the test as happened in the last test.

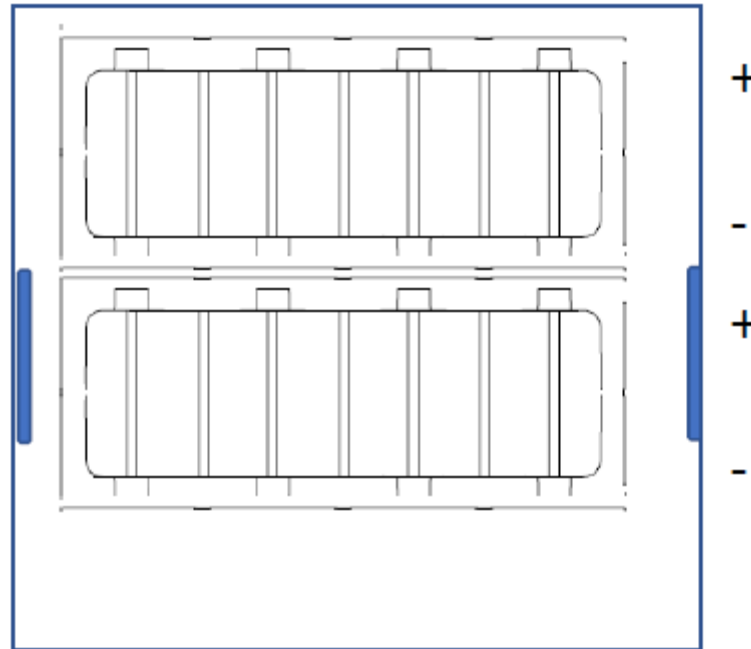

**Top View**

# Test 4 - Results



### Test 4 Module 1 Cell Temperatures and Voltage

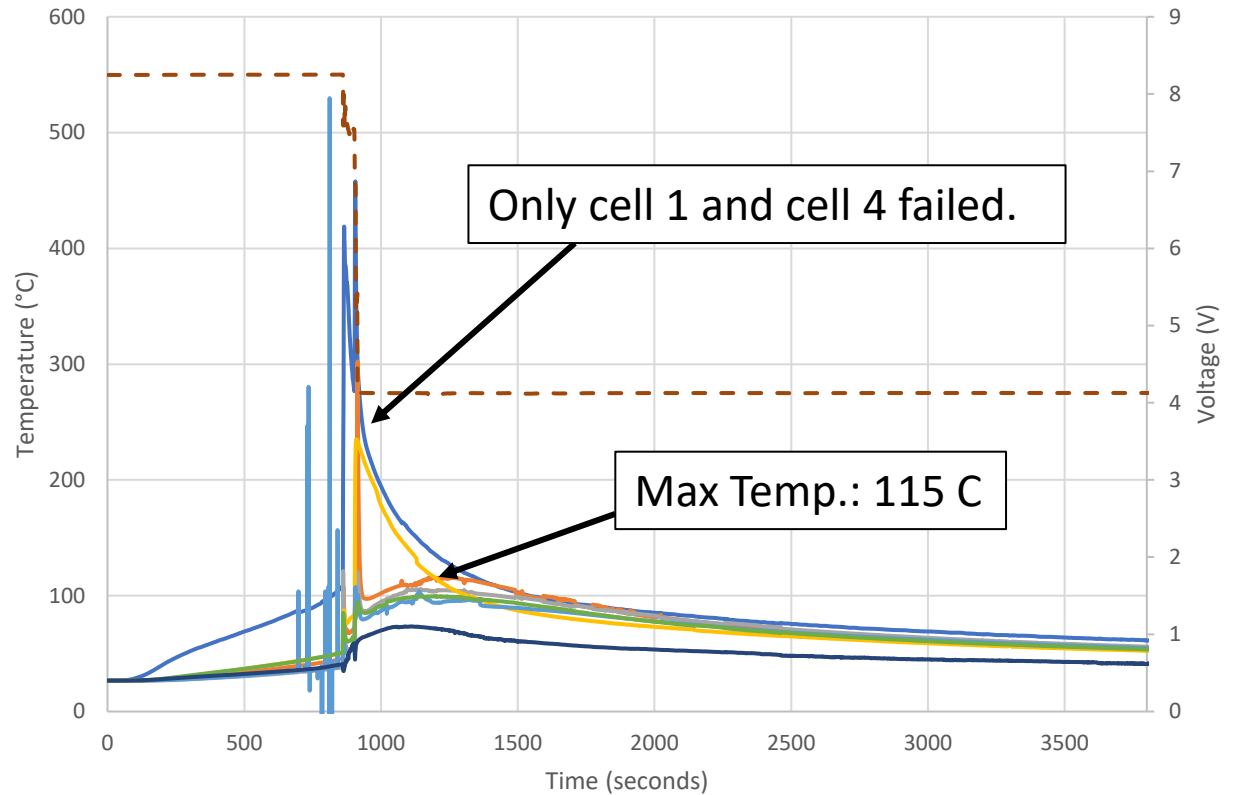

### Test 4 Module 2 Cell Temperatures

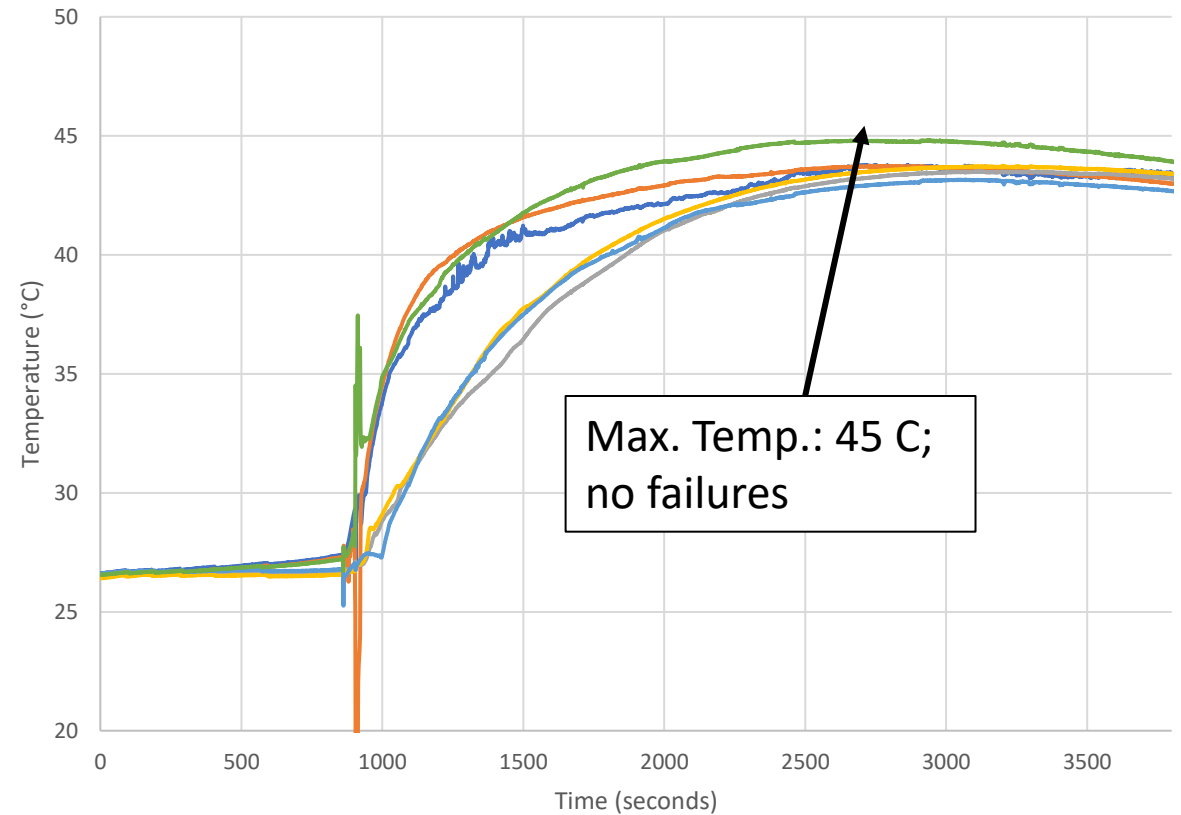

Trigger Cell Cell 2 Cell 3 Cell 4 Cell 5 Cell 6 Cell 7 Voltage

43.7916 43.7405 43.5134 43.7489 43.1651 44.8205

# Test 4 - Results



There is a single ejection point that was deflected off the S.S. in front of the positive vents and up to the top of the housing.



# Test 4 - Results



The T.R. event was localized to the 2-cell “unit” of the trigger cell and cell 4. Other cells got to 115 C but no other cells failed.

The utilization of the XTS phase change material was limited to the material directly in contact with the failed cells.



There are three main considerations when addressing ejecta thermal runaway:

- Capturing and converting the thermal energy.
- Quenching and extinguishing any flame that occurs.
- Blocking or deflecting ejecta particles and material.

These considerations must all be addressed. Just addressing one or two of these points will not completely mitigate thermal runaway.

Addressing thermal runaway is always a case-by-case problem. It requires reviewing the unique circumstances of each pack design.

- There is not a blanket off-the-shelf solution to addressing thermal runaway.

Companies like us at LHS are here for pack makers and designers to work with to make and test safer battery packs.

# LHS® Materials

## Safety and Pack Performance Improvement

Gunnar O'Connor  
Senior Product Development Engineer  
goconnor@lhsmaterials.com  
(303)-522-8292

Corporate Headquarters  
Latent Heat Solutions LLC  
831 Pine Ridge Road, Golden, CO 80403

[www.LHSMaterials.com](http://www.LHSMaterials.com)

