

Data-Driven Prediction of Long and Short-Term Li-ion Battery Degradation Using Public Datasets and Nail Puncture Testing

Presenter: Meghana Sudarshan¹

Casey Jones¹

Vikas Tomar¹

¹School of Aeronautics and Astronautics Engineering, Purdue University



Background

- High energy density from Li-ion batteries (LIBs) with various applications
 - Electric vehicles, electronic appliances like laptops, phones, etc.
- Thermal runaway in LIBs
 - Caused by short-circuits, over-charging/discharging, overheating

Safety Hazards

Samsung Galaxy Note 7^[1]



Tesla Accidents^[2]

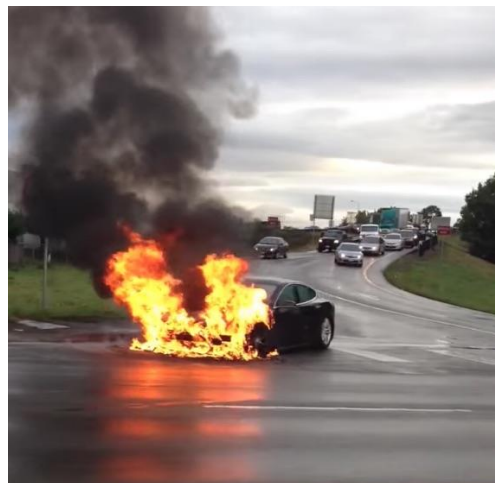

Boeing 787 Dreamliner^[3]



[1] https://news.softpedia.com/news/samsung-galaxy-s7-edge-catches-fire-while-charging-507925.shtml#sgal_1

[2] <https://www.cnn.com/interactive/2019/03/business/tesla-history-timeline/index.html>

[3] <https://www.npr.org/2013/01/25/170231466/boeings-787-problems-remain-a-mystery>

Background

- Safe operation is always a major concern for Li-ion batteries
- Many different factors can affect the response of batteries to physical damage
- Use of cycling and abuse testing datasets in Data-driven models
 - Good generalization capabilities, non-linear prediction, and self learning capabilities
 - They can analyze hidden information and patterns using battery sensor characteristic data

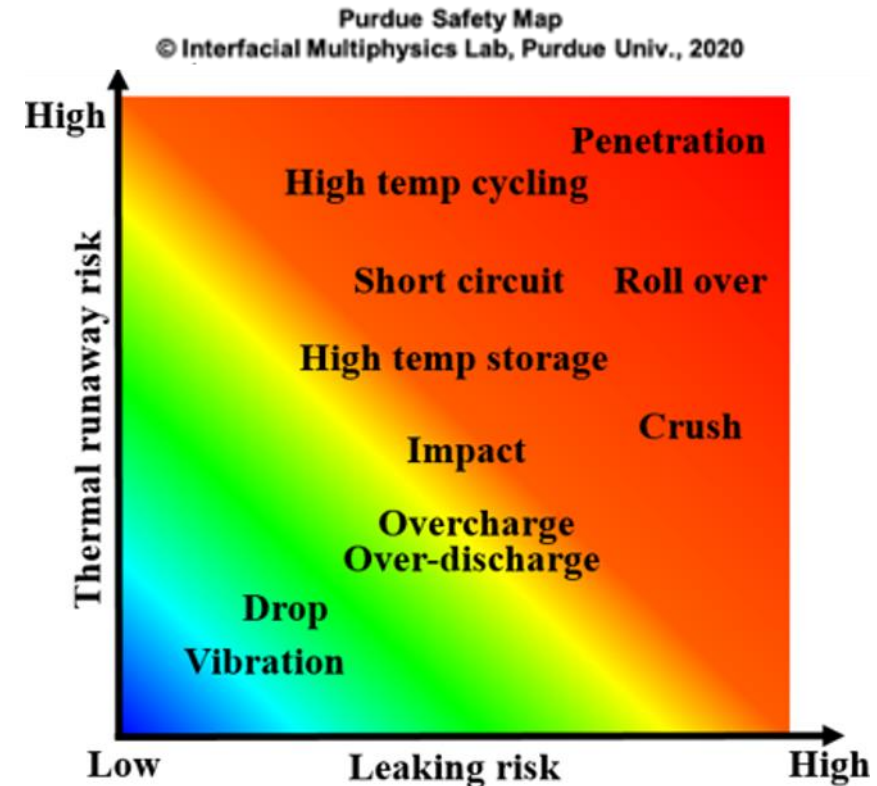

Interfacial Multiphysics Laboratory, developed by
Bing Li

Research Overview

- Battery state of health (SOH) cannot be measured directly
 - Estimated using externally measurable battery quantities like current, voltage, and temperature
- Classifying Li-ion battery datasets for long and short-term degradation
 - Public cycling datasets
 - Nail puncture testing data
- Propose data-driven models for long-term and short-term degradation
 - A correspondence between parameters of battery and internal state of charge of battery

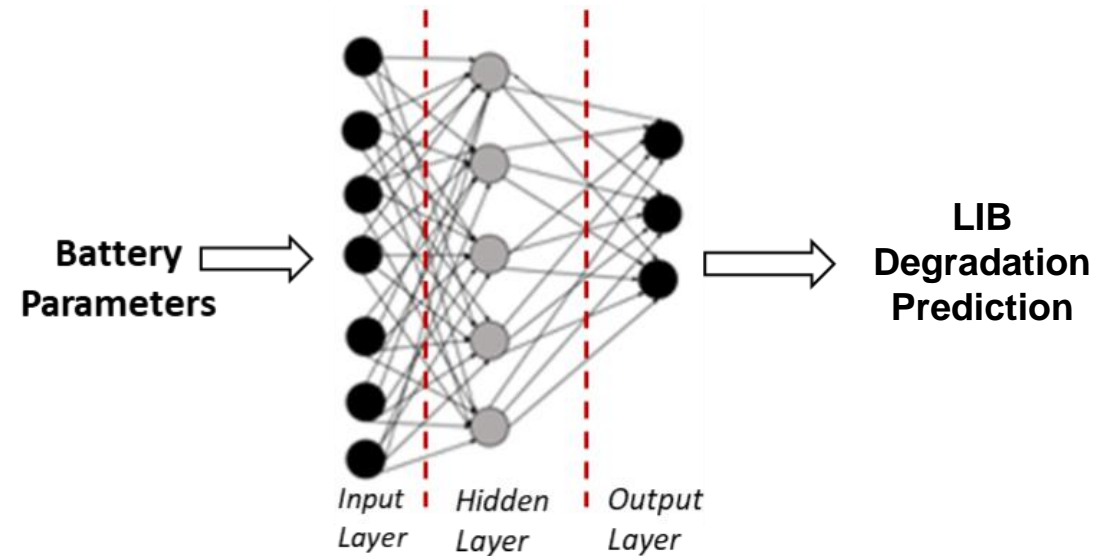

Long-term Degradation

- Classification of public datasets for BMS's is extremely beneficial in curating the data that is useful to input in ML applications
- Datasets improving model versatility

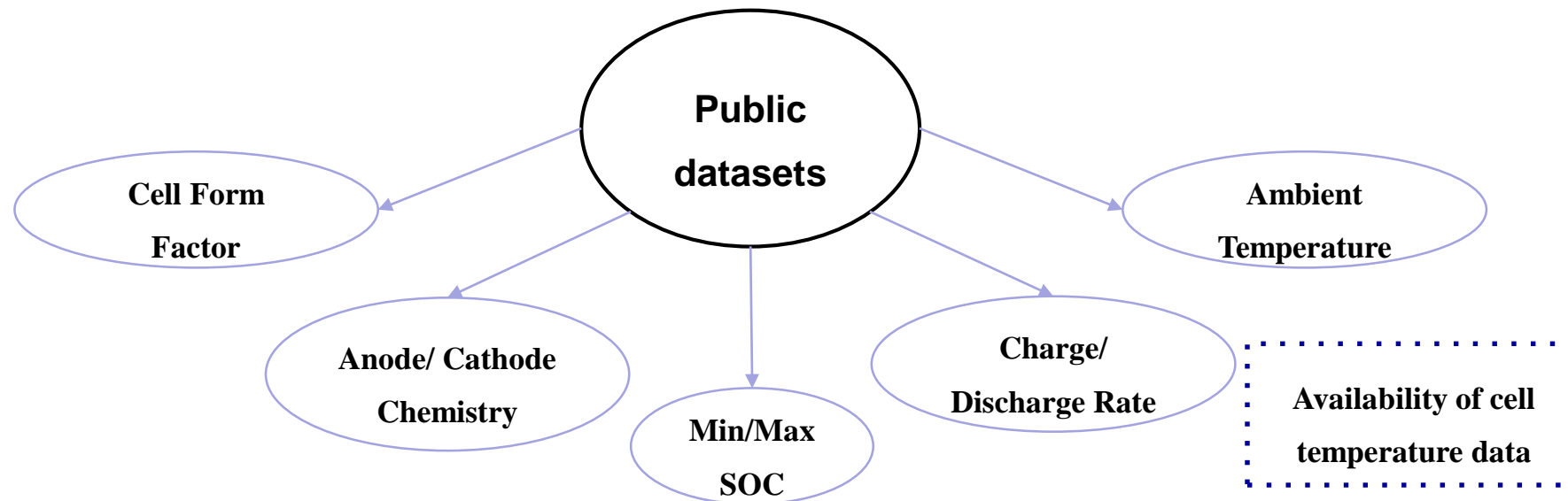

Publicly Available Data: Classification

Most large datasets became available in the past 5 years with *LFP* cell chemistry having largest amount of data

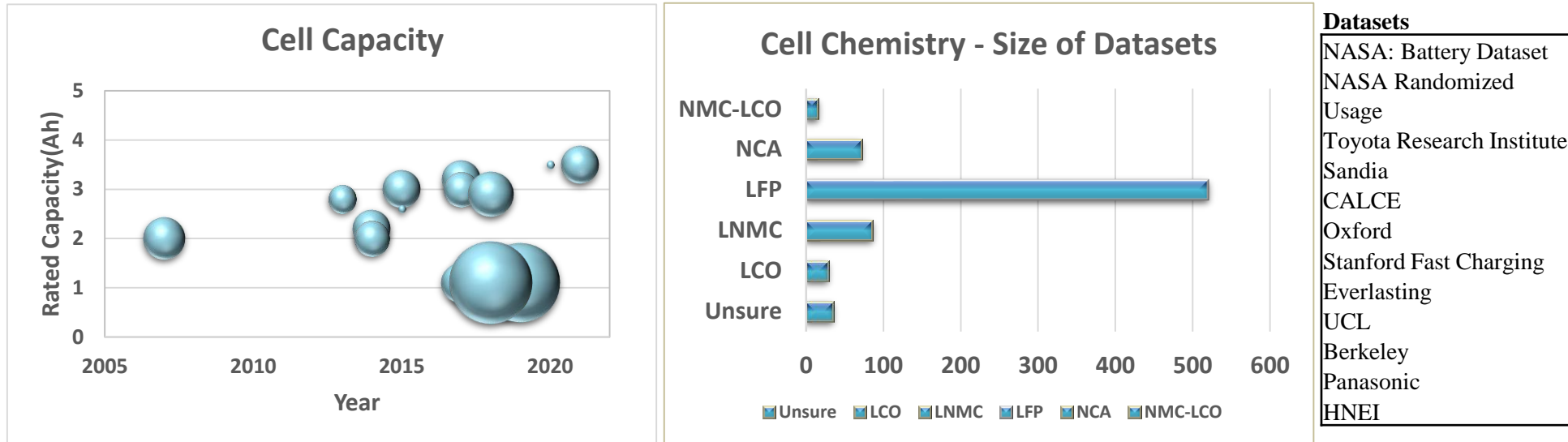

Public Datasets for Capacity Degradation

Capturing variabilities in battery cycling

- Different cycling profiles
- High/Low current
- High/Low voltage
- Charge/ Discharge rates
- Ambient Temperature

Features showing degradation

- Thermal runaway temperature
- Previous cycle capacity
- Cycle number

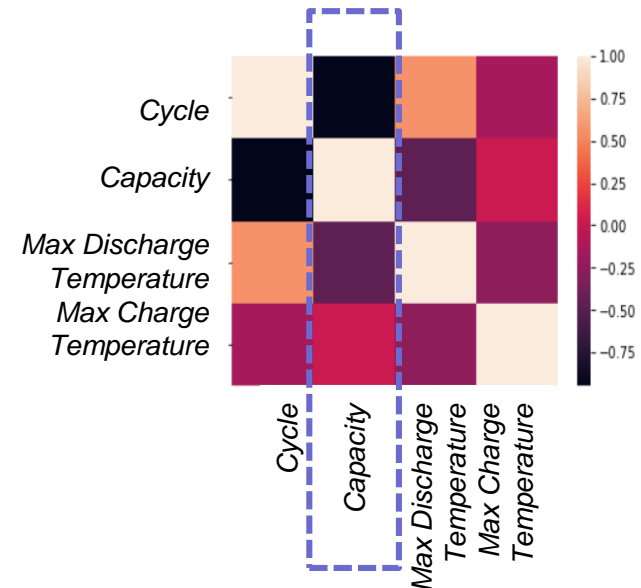
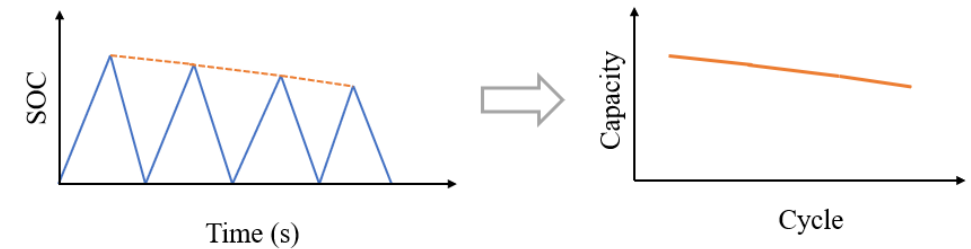

Short-term Degradation Data

- Short term degradation by abuse testing - nail puncture tests
- Use a drop hammer test rig with a nail attached to penetrate approximately halfway into cell
- Remove nail immediately after penetration to minimize time of short circuit
- Allow cell to cycle afterwards, monitoring temperatures and operating characteristics

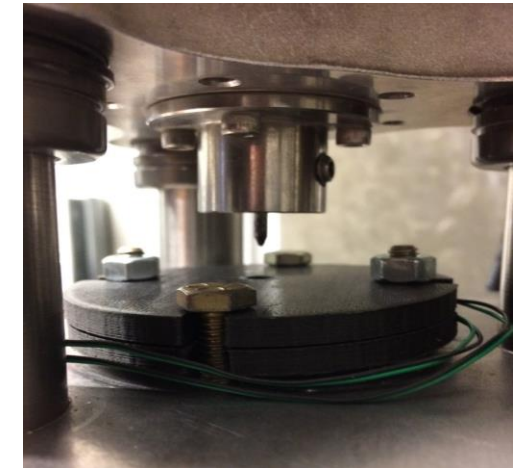
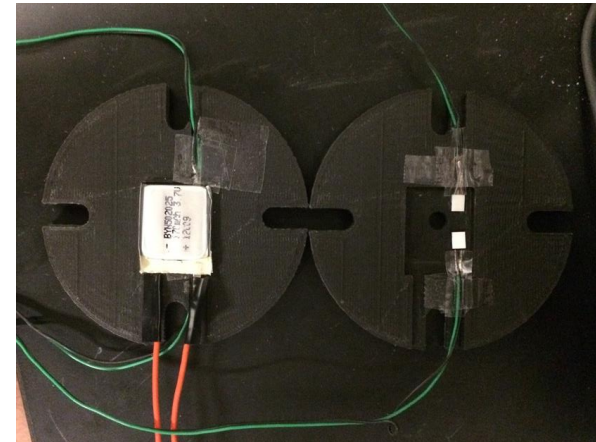
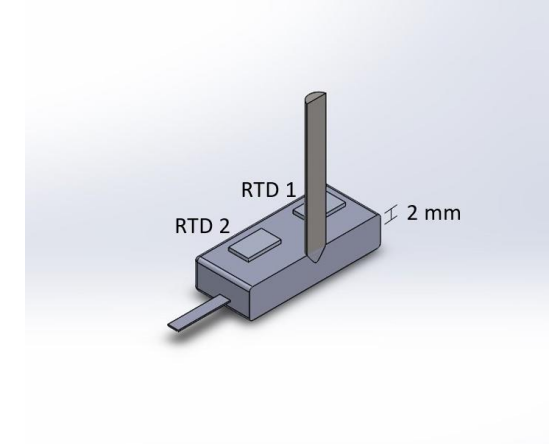
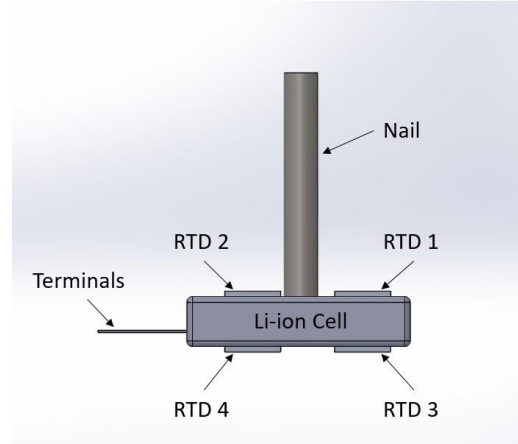

Jones, C., Li, B., and Tomar, V., "Determining the Effects of Non-Catastrophic Nail Puncture on the Operational Performance and Service Life of Small Soft Case Commercial Li-Ion Prismatic Cells," eTransportation 8 (2021): 100109

Short-term Degradation Data

- Cells experienced accelerated degradation during cycles after puncture
- Temperature increased rapidly on impact, peaking approximately 5-10 minutes afterwards

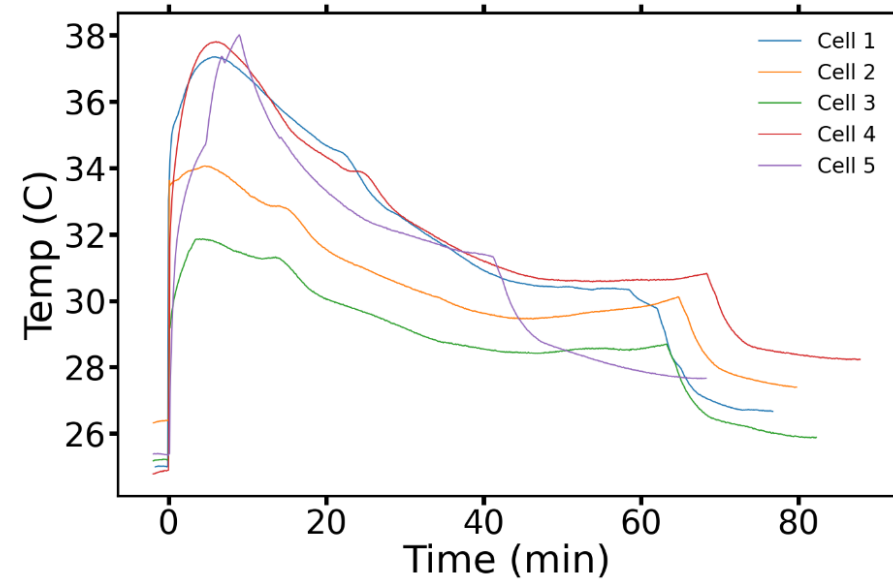
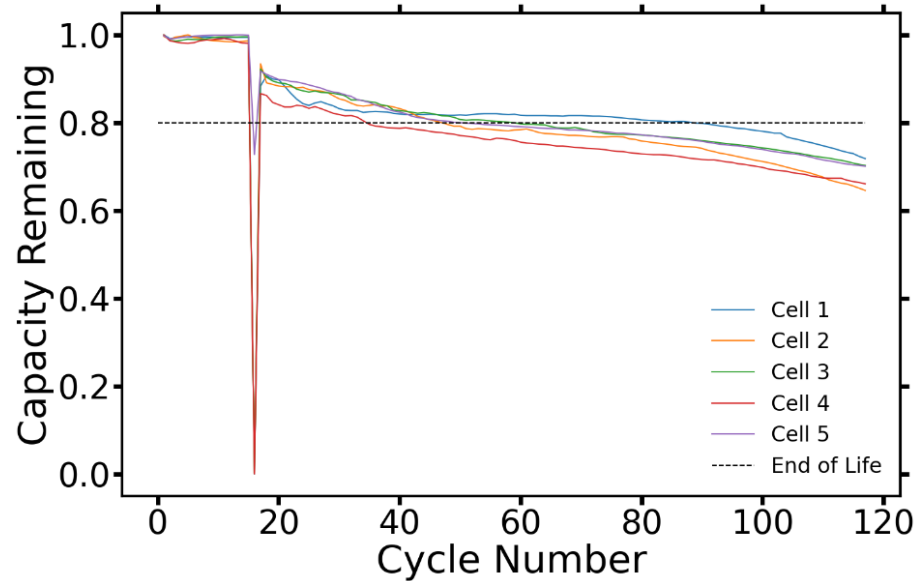

Jones, C., Li, B., and Tomar, V., "Determining the Effects of Non-Catastrophic Nail Puncture on the Operational Performance and Service Life of Small Soft Case Commercial Li-Ion Prismatic Cells," *eTransportation* 8 (2021): 100109

Nail Puncture: Capacity Degradation Prediction

- Operational factors can be used for linear regression-based predictions
- Features:
 - Cycle number
 - Charge capacity
 - Discharge capacity
 - Peak temperature
- To be predicted:
 - Fraction of capacity remaining

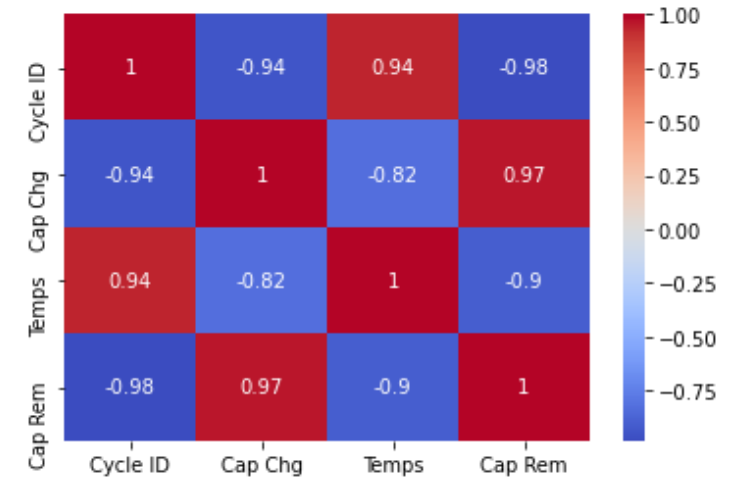

Results

For *long-term capacity degradation* prediction,

- Datasets used: NASA, Sandia National Laboratory, NASA Random Cycling, University of California at Berkeley
- MLP Regressor neural network model can be used for health estimation with an accuracy with test data of 94.3%
 - Can be improved with additional datasets based on factors applicable for usage

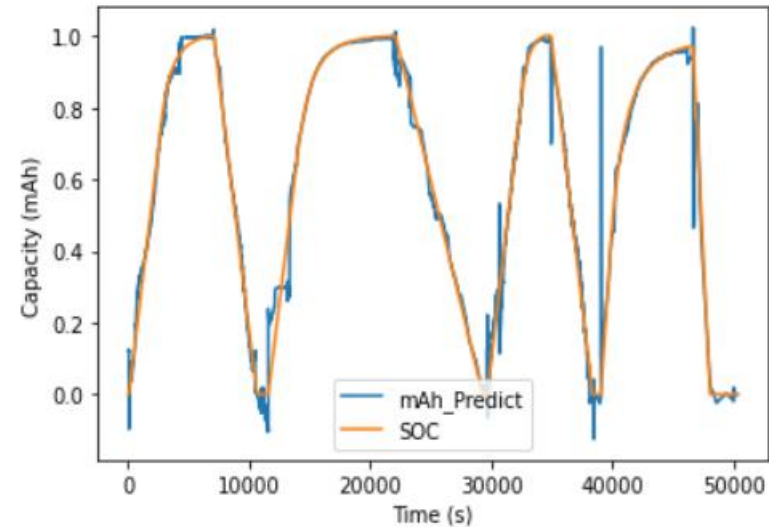

Results

For *short-term capacity degradation* prediction using nail puncture data,

- Perfect linear correlation between discharge capacity and capacity remaining
 - Capacity remaining is directly based on discharge capacity
 - Remove discharge capacity from model to eliminate false correlation
- Remove puncture cycle with significantly lower capacity
 - Outlier capacity value from nail puncture no longer skews results and predictions are much more accurate

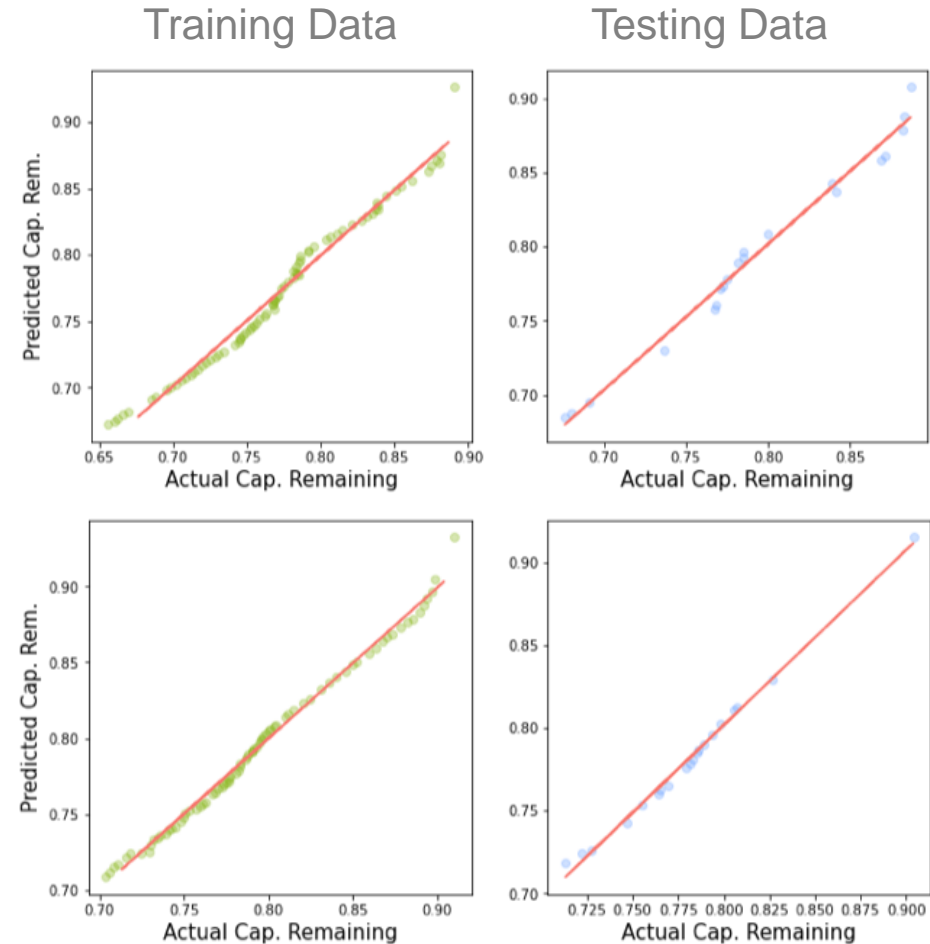

Summary

Long-term cycling degradation

Publicly available datasets were classified based on factors affecting health of LIBs

- Gathered usable datasets to cover maximum variability in cell cycling as input into the data-driven model
- Proposed neural network can be used for health estimation of LIBs for degradation prediction

Abuse testing degradation

Operational data from abusive testing was used to show how LIBs respond to damage

- Initiated and developed a method of predicting operational response of Li-ion batteries to nail puncture testing
- Began refinement of predictive method to discover other mechanisms of prediction and improve results of method

Future Work

- Combine data to make method more robust
 - Combine abuse testing data with cycling data for a single prediction model to study the combined effect before and after abuse
- Obtain more cycling data with nail punctures
 - Develop more accurate predictions and identify other operational factors for degradation
- Test different methods of capacity degradation prediction
- Additional features affecting life of batteries

Acknowledgements

- Office of Naval Research (ONR)
- Casey Jones, Bing Li, Dr. Vikas Tomar (Interfacial Multiphysics Laboratory, Purdue University)

Lab/Contact Information

- Interfacial Multiphysics Laboratory
 - www.interfacialmultiphysics.com
- Meghana Sudarshan
 - msudars@purdue.edu
- Dr. Vikas Tomar
 - tomar@purdue.edu





Questions?