



Executive Summary

During space missions, proper elimination and containment of human waste (feces, urine, menses, and vomit) and related hygiene is critical to consider when designing habitable volumes and capabilities for the crew. This should also include the periods of time when the crew will be suited for various activities or phases of the mission/flight. The waste management collection system and related products must be capable of collecting and containing maximum values of all forms of human waste.

Due to the close quarters and time spent in both microgravity and partial gravity, body waste and odors can be difficult to contain. Contamination from body waste can enter the body through the eyes, nose, mouth, ears, and cuts in the skin, which can lead to a variety of illnesses and infections. Additionally, microgravity conditions can cause unintended free-floating waste that can inadvertently (and unknowingly) soil a crewmember. Methods to prevent cross-contamination need to be considered during the vehicle design process. These methods may include isolating the body waste system from the personal hygiene areas and the food system, maximizing the distance between the systems, and employing appropriate cleaning and filtering techniques. The trash volume will need to consider the stowage of body waste and the associated trash (wipes, feminine hygiene products, etc.) that is not able to be reprocessed for water reclamation or other recycling activities.

Relevant Standards

NASA-STD-3001 Volume 2 , Rev C

- [V2 3006] Human-Centered Task Analysis
- [V2 6059] Microbial Air Contamination
- [V2 6063] Contamination Cleanup
- [V2 7016] Personal Hygiene Capability
- [V2 7017] Body Cleansing Privacy
- [V2 7020] Body Waste Management Capability
- [V2 7021] Body Waste Management System Location
- [V2 7022] Body Waste Management Privacy
- [V2 7023] Body Waste Management Provision
- [V2 7024] Body Waste Accommodation
- [V2 7025] Body Waste Containment
- [V2 7026] Body Waste Odor
- [V2 7027] Body Waste Trash Receptacle Accessibility
- [V2 7029] Body Waste Management Maintenance
- [V2 7035] Urine per Crewmember
- [V2 7064] Trash Accommodation
- [V2 7065] Trash Volume Allocation
- [V2 7066] Trash Stowage Interference
- [V2 7069] Labeling of Hazardous Waste
- [V2 7080] Particulate Control

- [V2 7081] Microbial Surface Contamination
- [V2 7082] Surface Material Cleaning
- [V2 7083] Cleaning Materials
- [V2 7085] Fecal and Urine Elimination Concurrence
- [V2 7101] Body Waste Isolation
- [V2 7102] Body Waste Quantities
- [V2 8001] Volume Allocation
- [V2 8005] Functional Arrangement
- [V2 8006] Interference
- [V2 10003] Crew Interface Operability
- [V2 11013] Suited Body Waste Management – Provision
- [V2 11014] EVA Suit Urine Collection
- [V2 11015] Suit Urine Collection per Day – Contingency
- [V2 11016] Suit Feces Collection per Day – Contingency
- [V2 11017] Suit Isolation of Vomitus
- [V2 11028] EVA Suit Urine Collection



Background

Previous Concerns from Crew

- Odor control is important and will affect a crewmember's appetite due to the strong smells following a bowel movement.
- Contamination from the Waste Management System (WMS) is difficult to mitigate when the food system is only 1-foot away.
- Maximum Absorbency Garments (MAGs) should be removed as soon as possible following suited ops due to skin irritations.
- Throughout the Apollo medical debriefs the crews reported that the system required ~45 minutes from start to finish for defecation.
- The fecal bag "doesn't stick to your butt well", so escapees happen and is described as "a complete mess."
- The Urine Collection Device (UCD) is uncomfortable, frequently leaks, and causes some irritation when used.
- The backpressure of the urine bag contributes to in-flight Urinary Tract Infections (UTIs).
- Concerns about voiding capability and hardware set-up time during time-critical operations.

Risks from Body Waste and Hygiene Contamination

In-mission risk:

- Cross contamination with fecal matter and other human waste is a known human health risk which can cause deleterious medical events to the crews' health and affect productivity (see medical event below).
- Due to the distance from Earth and limited resources, the inability to treat unexpected medical events can lead to loss of mission.

Possible medical events associated with contamination from body waste or use of body waste system:

- Gastrointestinal Distress (including gas, bloating, diarrhea, abdominal pain)
- UTIs
- Skin Rashes
- Infection
- Eye Irritation

Mission Duration

Shorter missions generally require less extensive personal hygiene facilities. Additional guidelines for determining facility needs are discussed in the Architectural Considerations section of the Human Integration Design Handbook (HIDH). For safety and health reasons, hygiene facilities must be designed to accommodate partial-body or full-body cleansing before and/or after these functions:

- Urination and defecation
- Exercise
- Medical activities
- Experimentation or other work requiring specialized washing
- Meal consumption
- Accidental exposure to toxic substances
- Eye contamination



Reference Information

Feces

- Fecal mass values are for the biological material only.
- Fecal collection and containment includes both the biological material and all hygiene products required for immediate body cleaning after defecation, but mass/volume quantities are limited to the body output only.
- The body will generate a predictable quantity of fecal material based on food consumption and an individual's metabolism. The variables to consider are the evacuation **frequency** and water **content**.
- The collection capacity requirements account for the **average healthy adult stool output/day (150 g/defecation at a rate of twice per day)**. The number of defecations per day is individually variable ranging from 2/week to 5/day, with the assumed average of 2/day.

Diarrhea







- Diarrheal events are assumed to be **in place of** normal fecal elimination with the increased quantity based on increased water content and minor amounts of intestinal cellular material.
- The 1.5 L of collection capacity requirement for diarrhea is based on the most likely maximal discharge in afflicted individuals. A crewmember could experience up to 8 diarrhea events (average volume of 0.5 L each) per day for up to 2 days, which must be accommodated.

Vomitus

- Space Adaptation Syndrome (SAS) occurs in up to 70% of first-time fliers (30% of whom may experience vomiting) during the first 48 to 72 hours of microgravity. In addition, a possible water landing may cause crewmembers to succumb to sea sickness. The average number of vomiting episodes per crewmember will vary from 1 to 6 per day, over a 2- to 3-day period.
- The waste management system must be capable of collecting and containing vomitus for up to 8 events of an average of 500 mL each. The maximum volume of expelled vomitus can be 1 L of solids and fluids, with a fully distended stomach. The average volume of vomitus is more likely to be 200 to 500 mL.

The Bristol Stool Chart

Adapted from the Bristol Stool Scale (Heaton et al 1992)

Type 1		Separate hard lumps, like nuts (hard to pass)
Type 2		Sausage-shaped but lumpy
Type 3		Like a sausage but with cracks on its surface
Type 4		Like a sausage or snake, smooth and soft
Type 5		Soft blobs with clear cut edges (passed easily)
Type 6		Fluffy pieces with ragged edges, mushy stool
Type 7		Watery, no solid pieces. ENTIRELY LIQUID

Note: Waste collection should accommodate all variations of stool, however "normal" feces is typically Types 3 & 4.

An artificial gravity study at the University of Texas Medical Branch and a Tufts University bed rest study examined the fecal weights of 32 subjects who consumed meals with a nutritional equivalent to that of current spaceflight meals. These studies resulted in an **average of 137.69 grams/event** with a **maximum event of 504.21 grams** (Warren et al.).

Reference Information

Urine

- The waste management system must be capable of collecting and containing a maximum total urine output volume of: $V_u = 3 + 2t$ liters per crewmember, where t is the mission length in days. Urine production on the first day after launch is 3 liters per crewmember. Urine output may be slightly greater or less in different phases of the mission (associated with g -transitions) and with different fluid intake levels. The average void will vary from 100 to 500 mL. Rarely, a single void might be as much as 1 liter, so the equipment must be able to accommodate this maximum.
- The capability must exist to collect 1 liter of urine per crewmember per hour. The rate of urinary delivery into the system from the body will vary by gender (greater for females because of lower urethral resistance) but averages 10 to 35 mL/s. Maximum flow rate with abdominal straining in a female may be as high as 50 mL/s for a few seconds and must be accommodated. The number of urinations per day is individually variable, with an average of six times per day, which must be accommodated.

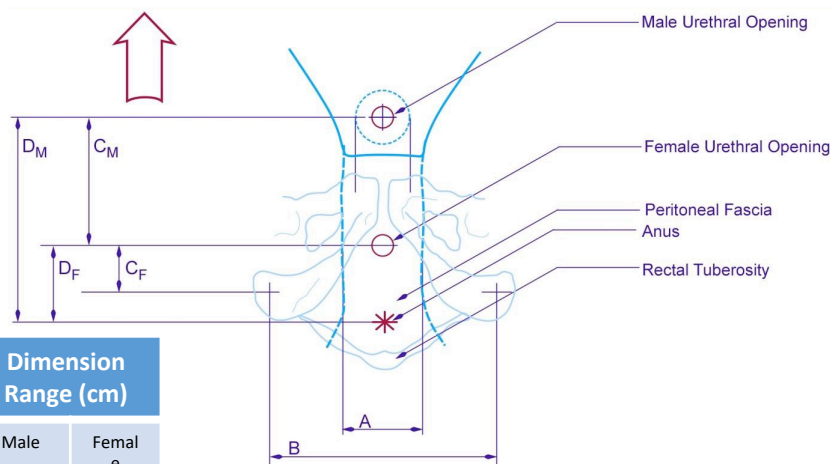

Anatomical Measurements for Body Waste Management Design

Anatomy	Description	Dimension Range (cm)	
		Male	Female
A	Lateral separation of ischial tuberosity	10-14	11-16
B	Width of perineal furrow	7.5-9	7.5-9
C	Anterior and posterior separation between tuberosities and exterior urethral opening	13-27	6-9
D	Anterior and posterior separation between anus and external urethral opening	15-30.5	9-11.5



Reference Information

Menses

Approximately once every 26 to 34 days and lasting 4 to 6 days, approximately 80% released during first 3 days. The capability must exist to collect and contain 113.4 grams per female crewmember per cycle.

TOILETS	Score	CLOTS	Score	TOWELS	TYPE	Score	TAMPONS	TYPE	Score in ml
	1ml		1ml		Day time	1ml		Regular	0.5
	3ml		3ml		Night time	1ml		Super	1.0
	5ml		5ml		Day time	2ml		Super Plus	1.0
					Night time	3ml		Regular	1.0
					Day time	3ml		Super	1.5
					Night time	6ml		Super Plus	2.0
					Day time	4ml		Regular	1.5
					Night time	10ml		Super	3.0
					Day time	5ml		Super Plus	4.0
					Night time	15ml		Regular	4.0
								Super	8.0
								Super Plus	12.0

The Menorrhagia Research Group 2004



ISS Waste Management System

Menses graphic illustrating the variability of flow and discharge during each cycle with corresponding product used. *Note: the type of product used is determined by the female, cycle day, and individual flow.*

Summary of Waste Standards

NASA-STD-3001 Volume 2 Rev C Table 16—Body Waste Quantities

Waste Type	Average Per Event	Maximum Per Event	Duration/Frequency
Feces^a	Volume: 150 mL (5 fl. oz.) Mass: 150 g (0.33 lb) Length: 4-23 cm (0.2-9.1 in)	Volume: 500 mL (16.9 fl. oz.) Mass: 500 g (1.1 lb) Length: 33 cm (13 in)	Average of two events per day
Diarrhea^b	Volume: 500 mL (16.9 fl. oz.) Mass: 500 g (1.1 lb)	Volume: 1500 mL (50.7 fl. oz.) Mass: 1500 g (3.3 lb)	Eight events per day for up to two days
Urine^c	Volume: 100-500 mL (3.4-16.9 fl. oz.) Flow Rate: 10-35 mL/s (0.34-1.2 fl. oz./s) Mass: 100.7-513.8 g (0.2-1.1 lb)	Volume: 1000 mL (33.8 fl. oz.) Flow Rate: 50 mL/s (1.9 fl. oz./s) Mass: 1027.6 g (2.3 lbs)	Average of six events per day
Vomitus	Volume: 500 mL (16.9 fl. oz.) Mass: (Varies dependent on stomach contents)	Volume: 1000 mL (33.8 fl. oz.) Mass: (Varies dependent on stomach contents)	Eight events per day for up to three days in-flight and post-landing
Menses per cycle^d	Volume: 30-50 mL (1.0-1.7 fl. oz.) Mass: (see footnote)	Volume: 114 mL (3.9 fl. oz.) Mass: (see footnote)	Approx. 80% released within the first 3-4 days

Note: a) Fecal material has a high water content and is assumed to have a specific gravity of 1.0 for the purposes of this specification. b) Diarrhea values account for fecal amounts. c) Normal values for urine's specific gravity are between 1.002 and 1.028, meaning a gallon of urine weighs between 8.362 and 8.579 pounds, or slightly more than water. d) Menses mass considerations will need to accommodate for the method of collection, i.e. pads and tampons.



Application

Design guidance and factors to consider:

- Protect crew from cross-contamination
 - Isolation of contaminant-generating functions (e.g., body waste, trash) is preferred
 - Physical separation of contaminant-sensitive functions (e.g., food prep and consumption) is an alternative
 - Provide adequate and appropriate provisions for cleaning and decontamination
- Control odor through ventilation and/or adequate containment
- Control microbial growth by using non-porous surfaces and providing appropriate and adequate cleaning provisions (NASA-STD-3001 Volume 2 Rev C [V2 6056] **Surface Cleanability**, NASA-STD-3001 Volume 2 Rev C [V2 7081] **Surface Material Selection**, NASA-STD-3001 Volume 2 Rev C [V2 7082] **Surface Material Cleaning**, NASA-STD-3001 Volume 2 Rev C [V2 7083] **Cleaning Materials**)
- Involve the intended user in development and testing for their input on usability in the operating environment
 - Impact of the lack of gravity during tasks
 - Body waste handling and personal hygiene for male and female crew
- Perform analysis to determine total waste expected for the mission and design for stowage and disposal

Note: See back-up slide Application Considerations for additional questions to consider when designing waste management systems.

Example daily collection and containment requirements during possible scenarios:

1) Three Healthy crewmembers for both Feces and Urine

Feces

Average per day: 150 g x 3 crewmembers x 2 defecations = **900 g avg/day**

Maximum per day: 500 g x 3 crewmembers x 2 defecations = **3000 g max/day**

Urine

Average per day: 320 mL x 3 crewmembers x 7 events = **6.7 L avg/day**

Maximum (assumption of only one max event):

(1 L x 3 crewmembers) + (430 ml x 9 events x 3 crew) = **12.6 L max/day**

2) Two Healthy crewmembers for Feces and One crewmember afflicted with Diarrhea

Feces

Average per day: 150 g x 2 crewmembers x 2 defecations = **600 g avg/day**

Maximum per day: 500 g x 2 crewmembers x 2 defecations = **2000 g max/day**

Diarrhea (value includes feces and expected higher water content)

Average per day: 500 mL x 1 crewmember x 8 events = **4.0 L avg/day**

Maximum: 1500 mL x 1 crewmember x 8 events = **12 L max/day**

Sample Urine Quantities Per Crewmember	
Metric (Average)	Qty
Events per day	~7
Maximum events per day	~9
Minimum events per day	~6.5
Volume (mL)	320
Maximum volume (mL)	430
Minimum volume (mL)	250

Note: Sample values from various crewmembers on ISS.

Note: Calculations use the sample values in table noted for average urine quantities and occurrences. The urine max, fecal, and diarrhea amounts use values found in NASA-STD-3001.



Back-Up



Application Considerations

Design and Operations Questions

- Where is the waste management system located in relation to the personal hygiene, sleeping quarters, food system, etc.?
 - Odors from body waste are expected to occur and are undesirable.
 - Contamination from the body waste system into the rest of the vehicle must be prevented.
 - Is the location of the body waste system near the food prep and consumption areas?
 - Are the crew and the food protected from microbial contaminants during waste management processes?
 - Are the locations of the body waste facilities, personal hygiene, food preparation, and trash area near each other? Are they at risk of cross-contamination? Will they be used simultaneously, risking cross-contamination?
- Is there adequate space for the expected output of waste and materials used during the collection process?
- Is the trash expected to be handled/transferred within another vehicle? Other crew? Or “dumped”?
- How will the trash management system minimize microbial growth or the spread of microorganisms?
- How will odors from elimination and trash stowage be controlled?
 - Will the crew be able to smell odors?
 - The crew have noted previously that the smell from the waste management system and body waste have been an issue during food consumption times leading to loss of appetite and reduced caloric intake.
- How much “involvement” from the crew is needed to control waste? (Do they have to “mix” their waste with product to neutralize?)
 - The use of fecal bags previously required that the crew use a finger slot to remove feces from the body and then mix within the bag to neutralize. This was not desirable by the crew.
- What kind of medical equipment will be used? How will medical waste and biological waste be contained?
 - Does the waste management system have the capability to contain sharp items and the associated biological waste?
 - What kind of biological hazards are expected to be stored?
 - How are biological hazards being stored? Is this storage near the food storage and prep areas? Or the personal hygiene and body waste areas?
- Can the crew immediately dispose of body waste and associated products after use?
 - The crew will need to be able immediately and easily dispose of body waste and product to avoid contamination of the vehicle and other common areas.
 - How are the crew collecting their waste (vomit, diarrhea, feces, urine, and menses)?
- Are the body waste management supplies within reach of the crew member during use?
- Will crew be able to immediately clean themselves or the area in case there is waste that is not properly contained or “escapes”?
- How will “splashing” be prevented?
- Will the crew be able to inspect their body to ensure they are clean of body waste due to difficulties in partial and microgravity, especially when waste is not contained properly?
- Will the crew have a level of privacy from the other crew (ex. curtain) during self-inspection, as well as during defecation, urination, or feminine hygiene activities?
- How will the system be cleaned and sanitized?
 - Can cleaning materials be used effectively without unwanted effects to the crew or systems?
 - Are the materials safe in areas where food is consumed? Compatible with the air/water systems?
 - Do the products leave unwanted or undesirable residues that could hinder or harm crew?
- Is daily or regular preventative maintenance required? If so, how long will this task take?



Major Changes Between Revisions

Rev B → Rev C

- Updated information to be consistent with NASA-STD-3001 Volume 1 Rev B and Volume 2 Rev C.

Rev A → Rev B

- Slide 2
 - Updated verbiage in examples.



Referenced Standards

NASA-STD-3001 Volume 2 Revision C

[V2 3006] Human-Centered Task Analysis Each human space flight program or project shall perform a human-centered task analysis to support systems and operations design.

[V2 6059] Microbial Air Contamination The system shall provide air in the habitable atmosphere that is microbiologically safe for human health and performance.

[V2 6063] Contamination Cleanup The system shall provide a means to remove or isolate released chemical and biological contaminants and to return the environment to a safe condition.

[V2 7016] Personal Hygiene Capability Personal hygiene items shall be provided for each crewmember, along with corresponding system capabilities for oral hygiene, personal grooming, and body cleansing.

[V2 7017] Body Cleansing Privacy The system shall provide for privacy during personal hygiene activities.

[V2 7020] Body Waste Management Capability The system shall provide the capability for collection, containment, and disposal of body waste for both males and females.

[V2 7021] Body Waste Management System Location The body waste management system shall be isolated from the food preparation and consumption areas for aesthetic and hygienic purposes.

[V2 7022] Body Waste Management Privacy The system shall provide privacy during use of the body waste management system.

[V2 7023] Body Waste Management Provision Body waste management supplies shall be provided for each crewmember and be located within reach of crewmembers using the body waste management system.

[V2 7024] Body Waste Accommodation The body waste management system shall allow a crewmember to urinate and defecate simultaneously without completely removing lower clothing.

[V2 7025] Body Waste Containment The system shall prevent the release of body waste from the body waste management system.

[V2 7026] Body Waste Odor The system shall provide odor control for the body waste management system.

[V2 7027] Body Waste Trash Receptacle Accessibility Body waste management trash collection shall be accessible to and within reach of crewmembers using the body waste management system.

[V2 7029] Body Waste Management Maintenance All body waste management facilities and equipment shall be capable of being cleaned, sanitized, and maintained.

[V2 7035] Urine per Crewmember The human body waste management system shall be capable of collecting and containing urine for either processing or disposal of an average total urine output volume of $V_u = 3 + 2.5t$ liters per crewmember, where t is the mission length in days.

[V2 7064] Trash Accommodation The system shall provide a trash management system to contain, mitigate odors, prevent release, and dispose of all expected trash.

[V2 7065] Trash Volume Allocation Trash stowage volumes shall be allocated for each mission.

[V2 7066] Trash Stowage Interference The system shall provide defined trash stowage that does not interfere with crew operations.

[V2 7069] Labeling of Hazardous Waste The hazard response level (HRL) of all liquids, particles, gases and gels shall be labeled on the outermost containment barrier in location(s) visible to crew.

[V2 7080] Particulate Control The system shall be designed for access, inspection, and removal of particulates that can be present before launch or that can result from mission operations.

[V2 7081] Microbial Surface Contamination The system shall provide surfaces that are microbiologically safe for human contact.

[V2 7082] Surface Material Cleaning The system shall contain surface materials that can be easily cleaned and sanitized using planned cleaning methods.



Referenced Standards

[V2 7083] Cleaning Materials The system shall provide cleaning materials that are effective, safe for human use, and compatible with system water reclamation, air revitalization, waste management systems, and spacesuits.

[V2 7085] Fecal and Urine Elimination Concurrence The body waste management system shall be capable of collecting and containing all waste during simultaneous defecation and urination.

[V2 7101] Body Waste Isolation For missions greater than 30 days, the system shall provide separate dedicated volumes for body waste management and personal hygiene.

[V2 7102] Body Waste Quantities The human body waste management system shall be capable of collecting and containing the various human body waste as specified in Table 16, Body Waste Quantities, for the expected needs of each mission and task.

[V2 8001] Volume Allocation The system shall provide the defined habitable volume and layout to physically accommodate crew operations and living.

[V2 8005] Functional Arrangement Habitability functions shall be located based on the use of common equipment, interferences, and the sequence and compatibility of operations.

[V2 8006] Interference The system shall separate functional areas whose functions would detrimentally interfere with each other.

[V2 10003] Crew Interface Operability The system shall provide interfaces that enable crewmembers to successfully perform tasks within the appropriate timeframe and degree of accuracy.

[V2 11013] Suited Body Waste Management – Provision Suits shall provide for management of urine, feces, menses, and vomitus of suited crewmembers.

[V2 11014] EVA Suit Urine Collection LEA suits shall be capable of collecting a total urine volume of $V_u = 0.5 + 2t/24$ L throughout suited operations, where t is suited duration in hours.

[V2 11015] Suit Urine Collection per Day – Contingency For contingency suited operations lasting longer than 24 hours, suits shall be capable of collecting and containing 1 L (33.8 fl oz) of urine per crewmember per day.

[V2 11016] Suit Feces Collection per Day – Contingency During contingency suited operations, suits shall be capable of collecting 75 g (0.17 lb) (by mass) and 75 mL (2.5 fl oz) (by volume) of fecal matter per crewmember per day.

[V2 11017] Suit Isolation of Vomitus Suits shall be shown to not create any catastrophic hazards in the event of vomitus from the crewmember.

[V2 11028] EVA Suit Urine Collection EVA suits shall be capable of collecting a total urine volume of $V_u = 0.5 + 2.24t/24$ L, where t is suited duration in hours.



Reference List

1. Apollo Medical Summit, NASA/TM-2007-214755
2. Apollo Flight Journal. *NASA History Division*. <https://history.nasa.gov/afj/>
3. Apollo Program Summary Report. *NASA Johnson Report JSC-09423*, April 1975. <https://www.hq.nasa.gov/alsj/alsj-JSC09423.html>
4. Human Integration Design Handbook (HIDH), Revision 1. (2014). https://www.nasa.gov/sites/default/files/atoms/files/human_integration_design_handbook_revision_1.pdf
5. Warrilow G, Kirkham C, Ismail KM, & Wyatt K. (2004). Quantification of menstrual blood loss. *The Obstetrician & Gynaecologist*, 6(2), DOI:10.1576/toag.6.2.88.26983.
6. Warren L, Paloski WH, & Camacho ME. (2007). Implementation of the NASA Artificial Gravity Bed Rest Pilot Study. *Journal of Gravitational Physiology*, 14(1).