



NASA HANDBOOK

NASA/SP-2010-3407/REV1

**National Aeronautics and Space Administration
Washington, DC 20546-0001**

**Approved: 06-05-2014
Expiration Date: NA**

**HUMAN INTEGRATION DESIGN HANDBOOK
(HIDH)**

BASELINE – January 27, 2010

REVISION 1 – June 5, 2014

DOCUMENT HISTORY LOG

Status	Document Revision	Approval Date	Description
Baseline		01-27-2010	Initial Release
Revised	1	06-05-2014	Revisions and Updates Throughout
Revised	2	10-20-2022	Revised Section 4: Anthropometry, Biomechanics, and Strength – See OCHMO-HB-004

ACKNOWLEDGMENTS

Primary points of contact: David R. Liskowsky, Medical Policy and Ethics Director, NASA Headquarters, and William W. Seitz, Habitability and Environmental Factors Division Chief, Johnson Space Center.

The following individuals are recognized as contributing practitioners to the content of this handbook:

- Core Team Member (or Representative) from Center, Directorate, or Office
- ◆ Supporting Team Member
- Subject Matter Expert Team

Christopher Allen, NASA / Johnson Space Center ●
Abbe Barr, Lockheed Martin / Johnson Space Center ●
Bettina Beard, NASA / Ames Research Center ●
Durand Begault, NASA / Ames Research Center ●
Jason Beierle, Lockheed Martin / Johnson Space Center ●
Charles Bowen, Lockheed Martin / Johnson Space Center ●
Jennifer Boyer, Lockheed Martin / Johnson Space Center ■●
Daniel Carr, Lockheed Martin / Johnson Space Center ●
Cynthia Collins, Lockheed Martin / Johnson Space Center ◆
Janis Connolly, NASA / Johnson Space Center ■●
Beth Cooper, NASA / Glenn Research Center ●
Richard Danielson, NASA / Johnson Space Center ●
John Dewitt, Wyle / Johnson Space Center ●
Charles Dodge, Wyle / Johnson Space Center ●
Laura Duvall, NASA / Johnson Space Center ●
Steve Ellis, NASA / Ames Research Center ●
Doug Ebert, Wyle / Johnson Space Center ●
Rick Evans, RHEvans Consulting ●
Meghan Everett, Wyle / Johnson Space Center ●
Garret Finney, Wyle / Johnson Space Center ●
David Fitts, NASA / Johnson Space Center ■
Tico Foley,* NASA / Johnson Space Center ■
Jerry Goodman, NASA / Johnson Space Center ●
Sandy Hart, NASA / Ames Research Center ●
Kritina Holden, Lockheed Martin / Johnson Space Center ●
Keith Holubec, Wyle / Johnson Space Center ■
Victor Ingurgio, Lockheed Martin / Johnson Space Center ●
John James, NASA / Johnson Space Center ●
Smith Johnston, NASA / Johnson Space Center ●

Kathryn Keeton, Wyle / Johnson Space Center ●
Jane Krauhs, Wyle / Johnson Space Center ◆
Keith Kreutzberg, Wyle / Johnson Space Center ■
Mark Leach, Wyle / Johnson Space Center ●
Stuart Lee, Wyle / Johnson Space Center ●
Lauren Leveton, NASA / Johnson Space Center ●
Jose Limardo-Rodriguez, NASA / Johnson Space Center ●
Jeffery McCandless, NASA / Ames Research Center ●
Torin McCoy, NASA / Johnson Space Center ●
Cherice Moore, NASA / Johnson Space Center ●
Darcy Miller, NASA / Kennedy Space Center ●
Cynthia Null, NASA / NASA Engineering and Safety Center ●
Judith Orasanu, NASA / Ames Research Center ●
Mark Ott, NASA / Johnson Space Center ●
Bonnie Park, NASA / Ames Research Center ●
Dennis Pate, SAIC / Johnson Space Center ●
Michele Perchonok, NASA / Johnson Space Center ●
Lynn Pickett, Lockheed Martin / Johnson Space Center ■
Duane Pierson, NASA / Johnson Space Center ●
Sudhakar Rajulu, NASA / Johnson Space Center ●
Mario Runco, NASA / Johnson Space Center ●
Dane Russo, NASA / Johnson Space Center ■
Aniko Sandor, Lockheed Martin / Johnson Space Center ●
Edward Semones, NASA / Johnson Space Center ●
Lou Silverstein,* Ames Research Center ●
Barry Spiering, Wyle / Johnson Space Center ●
Leland Stone, NASA / Ames Research Center ●
John Straub, Wyle / Johnson Space Center ●
Kenneth Stroud, NASA / Johnson Space Center ■●
Leah Stroud, Wyle Laboratories / Johnson Space Center ●
Richard Szabo, Lockheed Martin / Johnson Space Center ●
Sherry Thaxton, Lockheed Martin / Johnson Space Center ●
Barry Tillman, Lockheed Martin / Johnson Space Center ■●
Mary Van Baalen, NASA / Johnson Space Center ●
Kristian vonBengston, Consultant ●
Andrew Watson, NASA / Ames Research Center ●
Elizabeth Wenzel, NASA / Ames Research Center ●
Christopher Wickens, Alion Science and Technology ●
David Witwer, SAIC / Johnson Space Center ●
Neal Zapp, NASA / Johnson Space Center ●

*In memory of

TABLE of CONTENTS

1	SCOPE.....	4
1.1	PURPOSE.....	4
1.2	APPLICABILITY.....	5
1.3	HOW TO USE THE HIDH.....	5
2	APPLICABLE DOCUMENTS.....	9
2.1	GOVERNMENT DOCUMENTS.....	9
2.2	NON-GOVERNMENT DOCUMENTS.....	9
2.3	ORDER OF PRECEDENCE.....	10
3	GENERAL.....	13
3.1	INTRODUCTION.....	13
3.2	DERIVATION OF PROGRAM-SPECIFIC REQUIREMENTS.....	13
3.3	APPLICATION OF THE HIDH TO SYSTEM DESIGN AND DEVELOPMENT.....	20
4	ANTHROPOMETRY, BIOMECHANICS AND STRENGTH.....	38
4.1	INTRODUCTION.....	38
4.2	GENERAL.....	38
4.3	ANTHROPOMETRY.....	48
4.4	RANGE OF MOTION.....	62
4.5	REACH ENVELOPE.....	70
4.6	BODY SURFACE AREA, VOLUME, AND MASS PROPERTIES.....	77
4.7	STRENGTH.....	86
4.8	REFERENCES.....	93
5	HUMAN PERFORMANCE CAPABILITIES.....	102
5.1	INTRODUCTION.....	102
5.2	PHYSICAL WORKLOAD.....	102
5.3	SENSORIMOTOR FUNCTION.....	110
5.4	VISUAL PERCEPTION.....	127
5.5	AUDITORY PERCEPTION.....	155
5.6	COGNITION.....	178
5.7	COGNITIVE WORKLOAD.....	201
5.8	CREW COORDINATION AND COLLABORATION.....	237
5.9	REFERENCES.....	270
6	NATURAL AND INDUCED ENVIRONMENTS.....	335
6.1	INTRODUCTION.....	335
6.2	INTERNAL ATMOSPHERE.....	335
6.3	WATER.....	377
6.4	CONTAMINATION.....	394

6.5	ACCELERATION.....	398
6.6	ACOUSTICS.....	433
6.7	VIBRATION.....	466
6.8	IONIZING RADIATION.....	508
6.9	NON-IONIZING RADIATION.....	545
6.10	REFERENCES.....	564
7	HABITABILITY FUNCTIONS.....	583
7.1	INTRODUCTION.....	583
7.2	FOOD AND NUTRITION.....	583
7.3	PERSONAL HYGIENE.....	599
7.4	BODY WASTE MANAGEMENT.....	603
7.5	EXERCISE COUNTERMEASURES.....	607
7.6	MEDICAL.....	620
7.7	STOWAGE.....	623
7.8	INVENTORY MANAGEMENT.....	627
7.9	TRASH MANAGEMENT.....	630
7.10	SLEEP.....	636
7.11	CLOTHING.....	640
7.12	HOUSEKEEPING.....	643
7.13	RECREATION.....	650
7.14	REFERENCES.....	651
8	ARCHITECTURE.....	659
8.1	INTRODUCTION.....	659
8.2	OVERALL ARCHITECTURE DESIGN.....	659
8.3	LOCATION AND ORIENTATION AIDS.....	695
8.4	TRANSLATION PATHS.....	704
8.5	HATCHES AND DOORS.....	709
8.6	WINDOWS.....	712
8.7	LIGHTING.....	741
8.8	REFERENCES.....	793
9	HARDWARE AND EQUIPMENT.....	802
9.1	INTRODUCTION.....	802
9.2	GENERAL HARDWARE AND EQUIPMENT DESIGN.....	802
9.3	MAINTAINABILITY.....	806
9.4	TOOLS.....	812
9.5	DRAWERS AND RACKS.....	821
9.6	CONNECTORS.....	823
9.7	RESTRAINTS AND MOBILITY AIDS.....	828
9.8	CABLES.....	848
9.9	CREW PERSONAL EQUIPMENT.....	851
9.10	CLOSURES AND COVERS.....	853
9.11	FASTENERS.....	855
9.12	SAFETY HAZARDS.....	862

9.13	DESIGN FOR TRAINING.....	879
9.14	REFERENCES	885
10	CREW INTERFACES	900
10.1	INTRODUCTION	900
10.2	GENERAL	900
10.3	DISPLAYS DEVICES	907
10.4	CONTROLS	968
10.5	DISPLAY DEVICE AND CONTROL LAYOUT	1019
10.6	VISUAL DISPLAYS.....	1025
10.7	AUDIO DISPLAYS	1034
10.8	CREW SYSTEM INTERACTION	1041
10.9	CREW NOTIFICATIONS AND CAUTION AND WARNING	1045
10.10	ELECTRONIC PROCEDURES.....	1054
10.11	HARDWARE LABELS	1058
10.12	INFORMATION MANAGEMENT	1065
10.13	AUTOMATED SYSTEMS.....	1071
10.14	MOBILE SYSTEMS.....	1081
10.15	REFERENCES	1093
11	EXTRAVEHICULAR ACTIVITY (EVA).....	1105
11.1	INTRODUCTION	1105
11.2	LIFE SUPPORT FUNCTIONS	1105
11.3	EVA PERFORMANCE.....	1115
11.4	EVA SAFETY.....	1132
11.5	REFERENCES	1136
12	OPERATIONS - RESERVED	
13	GROUND MAINTENANCE AND ASSEMBLY - RESERVED	
	APPENDIX A ACRONYMS AND DEFINITIONS	1137
	APPENDIX B EXAMPLE DATA FOR ANTHROPOMETRY, BIOMECHANICS AND STRENGTH	1167
	APPENDIX C (Part 1) BASIC OPTICAL THEORY APPLIED TO WINDOWS & (Part 2) OPTICAL DESIGN GUIDELINES FOR GOOD WINDOWS	1235
	APPENDIX D OPTICAL PERFORMANCE REQUIREMENTS FOR WINDOWS IN HUMAN SPACEFLIGHT APPLICATIONS.....	1256

1 SCOPE

1.1 PURPOSE

The Human Integration Design Handbook (HIDH), NASA/SP-2010-3407, provides guidance for the crew health, habitability, environment, and human factors design of all NASA human space flight programs and projects.

The two primary uses for the handbook are to

- Help requirement writers prepare contractual program-specific human interface requirements – Users include program managers and system requirement writers.
- Help designers develop designs and operations for human interfaces in spacecraft – Users include human factors practitioners, engineers and designers, crews and mission / flight controllers, and training and operations developers.

The handbook is a resource document for NASA Space Flight Human Systems Standard (SFHSS), NASA-STD-3001. The SFHSS is a two-volume set of NASA Agency-level standards, established by the Office of the Chief Health and Medical Officer, that defines levels of acceptable risks to crew health and performance that result from space flight. Volume 1 of the SFHSS, Crew Health, sets standards related to crew health. Volume 2, Human Factors, Habitability and Environmental Health, defines the environmental, habitability, and human factors standards that are related to environmental health and human-system interfaces during human space flight.

The handbook is a resource for implementing the requirements in the SFHSS, and it provides the data and guidance necessary to derive and implement program-specific requirements that are in compliance with the SFHSS.

The scope of the handbook includes all crew operations both inside and outside the spacecraft in space and on lunar and planetary surfaces. It includes

- Design guidelines for crew interface with workstations, architecture, habitation facilities, and extravehicular activity (EVA) systems.
- Information describing crew human capabilities and limitations (both physical and cognitive)
- Environmental support parameters

The document uses the term “spacecraft” and “system” to refer to the volume in which humans live and work. The “humans” addressed in this document are the crew of the spacecraft. Spacecraft and system refer to all aspects of the crewmembers’ living and working conditions including the hardware, equipment, software, and environment. The term “human space flight program” is used to refer to the infrastructure assigned to design, develop, and deploy the spacecraft system.

1.2 APPLICABILITY

This handbook is applicable to

- All human space flight programs
- Internationally provided space systems as documented in distinct separate agreements, such as joint or multilateral agreements

This handbook is to be used to help meet the requirements defined in the SFHSS and may be referenced in contract, program, and other NASA documents for guidance. Individual portions of this handbook may be tailored (i.e., modified or deleted) by contract or program specifications to meet specific program or project needs and constraints.

1.3 HOW TO USE THE HIDH

The SFHSS is applicable to all human space flight programs. In accordance with the SFHSS, individual programs or projects must write a set of system-specific requirements that will meet the applicable standard requirements. The handbook provides the latest technological information and guidance for individual programs to meet the SFHSS. Program managers will use the handbook to craft requirements, and designers can use the handbook to help implement the requirements.

The handbook is divided into chapters that address major subject areas. Each chapter is divided into sections devoted to specific topics.

1.3.1 Chapters

The handbook is divided into 13 chapters, the last 9 of which address the range of human operations in space:

- Chapter 1, Scope – This chapter defines the scope and explains the content and use of the handbook.
- Chapter 2, Applicable Documents – This chapter lists the Government and non-Government documents applicable to the handbook. Each chapter also contains a list of references cited in that chapter.
- Chapter 3, Process and Requirements – This chapter contains general guidance on developing program-specific requirements and developing a human-system integration process throughout system design.
- Chapter 4, Anthropometry, Biomechanics, and Strength – This chapter includes information about the physical size, shape, reach, range of motion, strength, and mass of crewmembers. It explains how to determine the correct data for a project and how this information should be used to create a design that fits the crew.
- Chapter 5, Human Performance Capabilities – This chapter covers the physical, cognitive, and perceptual capabilities and limitations of humans in space flight. Topics covered include physical workload, visual and auditory perception, and cognitive workload.

- Chapter 6, Natural and Induced Environments – This chapter defines the habitable range for environmental factors (air, water, contamination, acceleration, acoustics, vibration, radiation, and temperature) that will ensure that humans can perform safely and effectively.
- Chapter 7, Habitability Functions – This chapter provides design considerations for the daily functions of the crew inside the spacecraft, including eating, sleep, hygiene, waste management, and other activities to ensure a habitable environment.
- Chapter 8, Architecture – This chapter provides guidance for the development and integration of overall spacecraft size and configuration, and layout of location and orientation aids, traffic flow and translation paths, hatches and doors, windows, and lighting.
- Chapter 9, Hardware and Equipment – This chapter provides overall human factors guidelines for the design of hardware and equipment such as tools, drawers and racks, closures, mounting hardware, handles and grasp areas, restraints, mobility aids, fasteners, connectors, visual access, packaging, clothing, and crew personal equipment.
- Chapter 10, Crew Interfaces – This chapter covers the design of interfaces through which information is exchanged between the crew and systems. Topics include visual displays, audio displays, controls, and labels.
- Chapter 11, Extravehicular Activities – This chapter covers the human factors design guidelines for EVAs performed by suited crewmembers outside the pressurized environment of a flight spacecraft (during space flight or on a destination surface). It also addresses off-nominal operations performed inside unpressurized spacecraft.
- Chapter 12 Operations - RESERVED
- Chapter 13 Ground Maintenance and Assembly - RESERVED

1.3.2 Chapter Organization

Each of the above chapters is subdivided into sections with detailed information. All the sections have a common format. The section elements are the following:

- Introduction
- Main Body – Design Guidelines, Lessons Learned, and Example Solutions
- Research Needs
- References

1.3.2.1 Introduction

The introduction identifies the topic(s) presented in the section and its scope. The introduction also identifies other sections of the handbook that might be of interest when

the subject matter is applied to space vehicles and habitations. For example, the contamination section refers to sections on food, housekeeping, water, and surfaces.

1.3.2.2 Main Body

The main body of the section contains data on human health and performance, guidance for human-system integration in spacecraft design, lessons learned from previous space flight or analog programs, and example solutions for design implementation.

The design guidelines provide designers and human factors practitioners with guidance and background information about the section topic. Background information and data needed for implementing program-level design requirements based on current research and subject matter expertise is also included. Information provided includes

- An overview of the section topic
- Background information
- Desirable design factors
- Design cautions or potential pitfalls
- Conditions (gravity environment, crew size, mission duration) under which the design features are applicable
- Data, including recommended limits and constraints
- Other factors that are important when considering the section topic (with references to other sections of the handbook)
- Problems that might occur when designing a system that meets design needs

Specific, concrete lessons learned from space or Earth-based analogs add examples from real life about previous successes to model, and mishaps or circumstance that compromise safety or efficiency to avoid.

Example solutions describe how human-system integration has been successfully implemented (specific hardware or operations) in designs. Specific constraints and peculiarities of the examples will be noted so that the program team can tailor the design solutions accordingly.

1.3.2.3 Research Needs

This element lists any specific unknowns (knowledge gaps) that are critical to the design of good human-systems interfaces. This information defines the limits of knowledge for system developers and can save them the time wasted in tracking down unavailable information. The HIDH will be updated to reflect the updated research and remaining needs.

1.3.2.4 References

Each chapter contains the references used in that particular chapter. These references are not an exhaustive bibliography of the topic, but rather a brief representation of useful classics and up-to-date materials.

2 APPLICABLE DOCUMENTS

2.1 GOVERNMENT DOCUMENTS

National Aeronautics and Space Administration

NASA-STD-3001	SFHSS, Volume 1, Crew Health SFHSS, Volume 2, Human Factors, Habitability, and Environmental Health
JSC 20584	NASA Spacecraft Maximum Allowable Concentration (SMAC) Tables
NASA-STD-6016 11 September 2006	Standard Materials and Processing Requirements for Spacecraft
JSC 63307	Requirements for Optical Properties for Windows Used in Crewed Spacecraft

2.2 NON-GOVERNMENT DOCUMENTS

American National Standards Institute (ANSI)

ANSI Z136.1	American National Standard for Safe Use of Lasers
-------------	--

American Society for Testing and Materials

ASTM D1003, Procedure A 10 June 2000	Standard Test Method for Haze and Luminous Transmittance of Transparent Plastics
ASTM D1044 1 November 2005	Standard Test Method for Resistance of Transparent Plastics to Surface Abrasion
ASTM E1559 10 May 2003	Standard Test Method for Contamination Outgassing Characteristics of Spacecraft Materials

Institute of Electrical and Electronics Engineers (IEEE)

IEEE C95.1	IEEE Standard for Safety Levels with Respect to Human Exposure to Radio-Frequency Electromagnetic Fields, 3 kHz to 300 GHz
------------	--

International Organization for Standardization

ISO 10110-7 1996	Optics and optical instruments - Preparation of drawings for optical elements and systems - Part 7: Surface imperfection tolerances
---------------------	---

United States Defense Standard (MIL-STD or MIL-SPEC)

MIL-C-48497 8 September 1980	Coating, Single or Multilayer Interference: Durability Requirements for
MIL-E-12397B 18 November 1954	Eraser, Rubber Pumice (For Testing Coated Optical Elements)
MIL-G-174 5 December 1986	Glass, Optical
MIL-PRF-13830B 9 January 1997	Optical Components for Fire Control Instruments: General Specification Governing the Manufacture, Assembly, and Inspection of
MIL-STD-1241 31 March 1967	Optical Terms and Definitions

2.3 ORDER OF PRECEDENCE

RESERVED

TABLE of CONTENTS

3	GENERAL	13
3.1	INTRODUCTION	13
3.2	DERIVATION OF PROGRAM-SPECIFIC REQUIREMENTS	13
3.2.1	Background and Preparation.....	14
3.2.2	Requirements Development.....	15
3.2.3	Verification Requirements.....	16
3.2.4	Review and Confirmation of Program-Level Requirements	19
3.2.5	Source of Requirements Information.....	19
3.3	APPLICATION OF THE HIDH TO SYSTEM DESIGN AND DEVELOPMENT	20
3.3.1	Introduction	20
3.3.2	Overview of the Design Process.....	20
3.3.3	Conceptual Phase	21
3.3.4	Preliminary Design Phase.....	22
3.3.5	Final Design and Fabrication Phase.....	23
3.3.6	Test and Verification Phase.....	24
3.3.7	Operations, Sustainability, Update, Retrofit, and Closeout Phases.....	24
3.3.8	Human-Centered Design	27
3.3.8.1	Concepts of Operation and Scenario Development.....	27
3.3.8.2	Task Analysis	29
3.3.8.3	Function Allocation between Humans and Systems	29
3.3.8.4	Iterative Conceptual Design and Prototyping.....	30
3.3.8.5	Empirical Testing (Design Evaluation and Iteration).....	30
3.3.8.6	Allocation of Roles and Responsibilities among Humans	32
3.3.8.7	In-situ Monitoring of Human-Systems Performance during Flight.....	32

TABLE of TABLES

Table 3.2-1 Verification Techniques..... 17
Table 3.3-1 HCD in System Design 25
Table 3.3-2 Example of Nominal Scenarios – Travel to ISS (Notional) 28

3 GENERAL

3.1 INTRODUCTION

This section provides information applicable to the overall design of a system. It describes the following:

1. How to use this handbook to write program-specific requirements that will meet NASA-STD-3001, Volume 2, Human Factors, Habitability and Environmental Health.
2. How to apply health and human factors information in this book to the design process throughout a development program to achieve a safe and effective design.

This document, the Human Interface Design Handbook (HIDH), is a companion to NASA-STD-3001, Volume 2.

NASA-STD-3001 is a broad set of criteria that ensures that humans are healthy, safe, and productive in space. Volume 1 focuses on human physiology and medical procedures and standards for maintenance and preservation of health. Volume 2 focuses on systems that interface with the human: controls, displays, architecture, environment, and habitability support systems. These systems must be configured for humans to carry out their mission effectively and safely.

The requirements in Volume 2 are a combination of both general and very specific criteria. In some cases, research and experience have determined an absolute need for a specific configuration or a specific set of environmental limits to maintain human health and productivity. In other cases, however, requirements are expressed in general terms (almost as goals). These requirements, though general, must also be met. The method for meeting the general requirements might vary with the specific system. Requirements may vary, for example, with such factors as crew size, mission duration, and gravity environment. There is no single, global method of meeting the standard.

In this handbook and in NASA-STD-3001, Volume 2, the term “requirement” refers to the global human interface design criteria in NASA-STD-3001. The term “system-specific requirements” refers to the design criteria for a specific system that will implement the requirements in NASA-STD-3001, Volume 2.

3.2 DERIVATION OF PROGRAM-SPECIFIC REQUIREMENTS

Program-specific requirements must be created for each individual program; creation of these requirements is specified in 3.2, Program-Specific Requirements [V2 3002], of NASA-STD-3001, Volume 2. Furthermore, all statements in NASA-STD-3001, Volume 2, with the word “shall” must be considered in the development of a program-specific set of human-systems design requirements. The creation of the program-specific requirements for Volume 2 must be started early in the program (in the conceptual stage).

Program-specific requirements will generally have two parts: human-systems design requirements and verification requirements.

1. Human-Systems Design Requirements – These specific design parameters will

ensure that the system meets the human performance and environmental requirements in NASA-STD-3001, Volume 2. Each “shall” statement in NASA-STD-3001, Volume 2, will have a corresponding human-systems requirement. These requirements may include the following:

- Habitability requirements that include upper and lower boundaries for environmental factors such as heating, vibration, noise, and atmospheric composition. These requirements can also define architectural features such as hatch sizes or workplace volume needs.
 - Design criteria to accommodate the human capabilities and limitations so that the crew can perform to meet system demands. These criteria might deal with the selection and placement of controls and displays or the interior layout of a spacecraft.
2. Verification Requirements – These requirements spell out steps to verify that the final system configuration meets the system-specific requirements.

Below is a description of the process for writing program-specific requirements and verifications, to assure effective and sustainable human-systems integration. The three phases to the requirement writing process include: 1) background and preparation, 2) requirements development, and 3) review. The background and preparation phase builds an adequate knowledge base to support the development of a comprehensive human-systems requirements set. The requirements development phase applies the knowledge gained from the preparation phase to develop the appropriate human-systems design requirements and verification requirements. The review phase ensures stakeholder concurrence and vetting of the proposed requirements set.

3.2.1 Background and Preparation

It is important to gather background information to develop an understanding of the intent of each NASA-STD-3001, Volume 2, standard and how these standards apply to the mission to be executed by the program under consideration. As with all system requirements, it is important that the preparation phase is completed before actual system development begins. Without an early understanding and definition of these requirements, the human-systems interface (including the entire system) could suffer, or costly corrections may be required later in the program development cycle. The background and preparation phase includes: 1) an in-depth definition of the program’s mission scope and design implementation methods (e.g., contract mechanism); 2) a thorough review of NASA-STD-3001, Volume 2, and other applicable Agency standards applicable to the program; and 3) a review of additional relevant documentation.

A careful review of the NASA-STD-3001, Volume 2, is necessary to clearly understand the intent of each standard. This handbook can be used as an important resource in achieving an in-depth understanding and intent of the NASA-STD-3001, Volume 2, standards. Within this handbook, the word “must” is used to help the requirement writer locate statements and criteria that may serve as resource material for program-specific requirements. Furthermore, a “should” in this handbook identifies a recommendation. In some cases, the criteria in NASA-STD-3001, Volume 2, are very detailed and specific. Translation of these specific standards into program-specific requirements may involve only slight modification of the original standard. For the “general” or nonspecific standards, the author will have to tailor the requirement for a particular system and mission. In this

case, the author must ensure the program-specific requirements meet the intent of the standard. Although some terminology in a “general” requirement in NASA-STD-3001, Volume 2, cannot be directly verifiable, the terms have meaning. For example, the word “minimize” means that design parameters need to fall within an acceptable range and should be as low as possible within that range.

A program mission scope must be developed to understand applicability of the NASA-STD-3001, Volume 2. For example, if the mission scope does not include a lunar destination, Agency standards related to lunar habitation or lunar dust exposure are not applicable to the program and are not incorporated into the program requirements set.

How NASA-STD-3001, Volume 2, has been applied to other programs can and should be reviewed to gain a comprehensive understanding of existing documentation and associated lessons-learned from other programs. In addition, a review of existing program documentation such as a program requirements document or a program operational concepts document should be conducted. Background and preparation activities should be coordinated with the other systems development groups (engineering, safety, reliability, training, etc.). A systems engineering effort can implement this coordination. This coordinated effort helps identify whether particular standards should be covered elsewhere, or whether any non-applicability is due to existing constraints or agreements. Any conclusions reached, assumptions developed, or methodologies employed as part of this discovery period should be described in the foreword or introduction section of a program requirements document so that this valuable data and scope is captured within the requirements set.

A tracking mechanism should be employed during the background and preparation phase to trace the Agency standards to the program-specific requirements, and to keep a record of rationale behind the applicability (or non-applicability) of those standards to the program mission. The tracking mechanism also documents related requirements from other documents (both within the program and from other programs) as well as the contributions from Subject Matter Experts (SMEs) and integrators who participate in the development of the requirements and verifications. Additionally, the tracking mechanism functions as a clear requirements trace and historical development path for each program requirement and associated verification. Before development of the program requirement set begins, the tracking mechanism must be approved by the governing NASA Technical Authority/Authorities. The focus of the approval is on the applicability of each requirement in the NASA-STD-3001, Volume 2, ensuring that the standard is applied appropriately.

3.2.2 Requirements Development

With an understanding of the intent of each Agency standard and how they apply to the program-specific mission(s) under consideration, development of the appropriate requirements and verifications set begins. Each of the applicable Agency standards must be addressed. It must be understood that, when developing program requirements, the program-level requirements must be written so that they are verifiable. Some, but not all, Agency standards are verifiable as written. Many of the verifiable standards are based on maxims of human interface that apply across all systems and environments. Little or no tailoring will be required when making these into program requirements. Other Agency standards are generic, are not verifiable as written, and must be adapted to the specific program to generate a verifiable requirement. In some cases, supplementary

documentation has been developed to assist with the transition from a generic standard to a verifiable program requirement. It is essential to note here that SME participation is important in the preparation of requirements and/or confirmation that developed program requirements meet the intent of Agency standards.

Program-level requirements may be either functional design requirements or design constraints. Basic requirements development rules are followed to clearly define design expectations and parameters. The characteristics of a good requirement statement are that it must be concise, simple, stated positively, grammatically correct, and unequivocal. Furthermore, program-specific requirements statements must be:

Clear

1. Interpreted in only one way
2. Stated positively (i.e., using “shall” instead of “shall not”)
3. Free of ambiguities (e.g., as appropriate, etc., and/or, be able to)
4. Free of indefinite pronouns (e.g., this, these)

Correct

1. Free of implementation (do not prescribe a design solution)
2. Free of descriptions of operations (ask “Does the developer have control over this?”)
3. Each requirement is necessary to meet the standard

Consistent

1. Not redundant with other requirements
2. Does not conflict with other documents
3. Defined at the correct level (again, ask “Does the developer have control over this?”)

Verifiable

1. Contains a clear and measurable pass/fail criterion

Once a requirement is written, a rationale statement must be written. A rationale statement should be written for all requirements. Rationale statements clarify the requirement by providing a brief background and justification for the requirement, explanation of intent of the requirement, and expectations for design implementation including any numerical values. If data values or limits are different or expanded from what is documented in the Agency standard, a justification for this difference is to be included in the rationale of the program requirement.

3.2.3 Verification Requirements

A verification requirement is necessary to ensure that requirements are properly understood, interpreted, and implemented. Verification statements are developed in parallel with requirements statements to ensure clarity of each. Verification statements specify a verification method of test, analysis, demonstration, or inspection, and define the steps to meet specified success criteria. The selection of a verification method is weighed against the importance, risk, precision, sensitivity, and consequences of the requirement. Verification statements must be objective: repeatable results must be obtained regardless of the measurement personnel. See Table 3.2-1 Verification Techniques for specific guidelines on developing verifications. The rationale of the verification statement clarifies intent by providing background information and details of the required methodology, as necessary.

Table 3.2-1 Verification Techniques

Verification Technique	Selection Criteria	Example
Inspection	<p>If a person can observe or use a simple measurement to determine whether the requirement is satisfied, Inspection is proper method.</p> <p>The risk with this method is inherent in the fact that an inspector makes the measurement or judgment.</p> <p>Inspection is typically the least expensive verification method.</p> <p>Attributes for verification: What is to be inspected, How is it to be inspected, Who will inspect it, What is the success criterion?</p>	<p><i>Requirement:</i> The system shall provide Personal Protective Equipment (PPE) for each crewmember in the event of an emergency.</p> <p><i>Verification:</i> The provision for stowage space of PPE shall be verified by inspection. The inspection shall include a review of the system design to ensure accessible stowage space for PPE. The inspection shall identify the presence of PPE. The verification shall be considered successful when the inspection identifies adequate stowage space and the presence of PPE.</p>
Test	<p>If an experiment and subsequent data analysis are needed for verification, Test is the proper method.</p> <p>A Test verification should provide a thorough description of the experiment.</p> <p>The success criteria for a Test may be best stated probabilistically.</p> <p>Test is typically the best and most effective method to quantify and reduce risk. Testing can be expensive. Attributes for verification: the measure, initial conditions, assumptions, experiment description, hardware and software to be used, success criterion.</p>	<p><i>Requirement:</i> The system shall limit impulse noise levels at the crewmember's head location to less than 83 dB during crew sleep periods.</p> <p><i>Verification:</i> The Impulse Annoyance Noise limit shall be verified by test. The measurements shall be made within the vehicle in the flight configuration with integrated Government-furnished equipment (GFE), portable equipment, payloads, and cargo installed. Hardware shall be operated at settings that occur during crew rest periods. Measurements shall be made, using a Type 1 integrating- averaging sound level meter, at expected sleep station head locations. Measurement locations shall be no closer than 8 cm from any surface. Peak-hold sound pressure level measurements (impulse noise) shall be made. The verification shall be considered successful when measurements show that the peak overall sound pressure levels are less than 83 dB.</p>

Analysis	<p>If verification can be accomplished by evaluation of equations, Analysis is the proper method.</p> <p>The risk with Analysis is inherent in the assumptions and model fidelity.</p> <p>Analysis is generally much less expensive than Test.</p> <p>Attributes for verification: the measure, initial conditions, assumptions, sources of equations, details of simulation, hardware and software to be used, success criterion.</p>	<p><i>Requirement:</i> The system shall provide a minimum of 2.0 kg (4.4 lb) of potable water per crewmember per mission day for drinking.</p> <p><i>Verification:</i> The provisioning of the specified quantity of potable water shall be verified by analysis. The analysis shall determine the amount of potable water stowage on the vehicle for all vehicle configurations. The verification shall be considered successful when the analysis shows sufficient volume and mass capacity for stowage of potable water in the amount of 2.0 kg (4.4 lb) of potable water per crewmember per mission day (in addition to other potable water requirements), using maximum crew size and maximum mission duration.</p>
Demonstration	<p>If verification can be accomplished with an experiment on actual system hardware or software, and only a single datum or result is needed (no data analysis, a simple pass/fail), then Demonstration is the proper method.</p> <p>A Demonstration is usually performed at the extremes in range of performance (i.e., worst-case environment or scenarios).</p> <p>The risk with Demonstration is that there is only one datum on which the pass/fail decision is made.</p> <p>Attributes for verification: the measure or function, initial conditions, assumptions, specific instructions, hardware and software to be used, success criterion.</p>	<p><i>Requirement:</i> Window covers, shades, and filters that are designed to be removed and replaced during flight shall be removable in less than 10 seconds and replaceable in less than 10 seconds.</p> <p><i>Verification:</i> Window cover, shade, and filter removal or replacement in less than 10 seconds shall be verified by demonstration. The demonstration shall occur in the vehicle or high-fidelity mock-up thereof. The demonstration shall consist of removing and then replacing each window cover, shade, and filter without the use of tools by a crewmember test subject who shall be selected by NASA. The verification shall be considered successful when the demonstration shows that each cover, shade, and filter is removable in less than 10 seconds and replaceable in less than 10 seconds.</p>

To determine the best verification method(s), several considerations need to be made concerning the type of requirement, the success criteria, and, to some extent, cost and schedule. The selection of verification method(s) should be weighed against the importance, risk, precision, sensitivity, and consequences of the functional requirement.

3.2.4 Review and Confirmation of Program-Level Requirements

The final step in development of program-specific requirements from Agency standards is to conduct a broad stakeholder review. It is important that the requirement set is distributed as a whole to ensure stakeholders have the context of each requirement during their review. Stakeholders and SMEs should also be provided with the assumptions and approach determined during the background phase of development. This is done to ensure that the context of how the standards were applied to the program under consideration is understood. Such information may not be evident from either the requirement or the rationale statement.

Reviewers should be given clear directions on what is expected from them during the review, including areas of focus and an overall schedule for the review. Reviewer comments are addressed openly by providing the reviewers with rationale to each recommended disposition. An agreement with the reviewers must be reached on the disposition for each comment. If agreement cannot be reached, the comment must be addressed at the appropriate review board.

Relevance to the Agency standards must be considered during the review process. If the program has accepted additional risk by waiving or deviating from the originating standards, the program must document the risk posture acceptance and associated rationale. If additional information that clarifies the standards is uncovered during the review, the information could be applied to modify the standards, add rationale to the standards, or modify an associated document, such as a handbook. Modifications to the standards should be considered, but are not mandated.

3.2.5 Source of Requirements Information

This handbook is an available source of information used to create the system-specific requirements. It contains information from the latest research about human health, habitation, and performance in space. However, NASA recognizes that handbook updates will lag science. Systems developers may wish to propose using supplemental or alternative information.

3.3 APPLICATION OF THE HIDH TO SYSTEM DESIGN AND DEVELOPMENT

3.3.1 Introduction

The following section discusses the development of a system and how the information in this handbook on human health, habitation, and performance can be integrated into the design. This section is meant to help program planners, designers, and human factors and health practitioners achieve a successful integration of humans and systems.

The information in this section coordinates with NASA/SP-2007-6105, Systems Engineering Handbook. In that reference, one can find further information on the design process and on human factors analytical techniques.

3.3.2 Overview of the Design Process

All design and development programs evolve through the same general phases:

- Conceptual
- Preliminary Design
- Final Design and
- Fabrication Test and
- Verification
- Operations and
- Sustainability Update
- and Retrofit
- Closeout

If the system includes a crew, the human component must be considered along with the other components throughout systems development. The procedure for including the human in the design process is often referred to as human-system integration (HSI); however, to more closely align with content within NASA-STD-3001, we will refer to this process as human-centered design (HCD).

In a systems development effort, a Human Factors group is usually responsible for the human component of the system (the “crew”). In this role, Human Factors is central to the HCD process and will have the primary responsibility for the use of this handbook. This section will focus on the Human Factors efforts during the systems development process.

Well-designed human-system interfaces are critical for crew safety, productivity, and ultimately mission success. An HCD program must address the physical and cognitive capabilities and limitations of the human occupant, the constraints of the spaceflight environment, and the tasks to be performed. The lack of a quality HCD program makes it more likely that problems will arise late in the systems development cycle, resulting in increased risk of slipped schedules and increased costs. Even worse, human interface problems may arise when the system is deployed, resulting in degradation of performance or safety.

A systems development program involves a variety of groups that focus on particular areas of the design. These groups have different names, depending on the organization. In this discussion, we will refer to the following groups:

Human Factors – Focuses on human performance and ensures the integration of the human- system requirements into the design

Systems Engineering – Coordinates all engineering specialties, sets design parameters, and conducts tradeoff studies

Design Engineering – Responsible for the final hardware and software configuration

Mission Planning – Responsible for defining the system mission and basic operating procedures

Safety – Responsible for human and systems safety

Health – Manages crew health

Crew Selection – Defines and enacts crew selection criteria

Training – Prepares the crew for safe and effective performance during the mission

An HCD program plan should be developed that defines how the Human Factors group integrates with the other organizations throughout a systems development program to ensure that humans are healthy, safe, and productive in support of human spaceflight missions. An HCD program plan should contain:

The general Human Factors Engineering (HFE) program goals and scope

A high-level concept of operations for the new system

HFE design team skills necessary to conduct subsequent HFE

Activities (responsibilities of the main design team and contractors should be clearly stated) Engineering procedures (such as quality assurance and the use of an issues-tracking system) to be followed

Description of HFE products and documentation of analysis and results

Key milestones and schedule to ensure the timely completion of HFE products

This section will briefly describe an HCD process during systems development, including the coordination of the systems development groups. Along with a brief description of each program phase, this section will show how this handbook can be used. Table 3.3-1 at the end of this chapter summarizes this information.

3.3.3 Conceptual Phase

During the Conceptual Phase of systems development, designers define what the system is intended to do and make broad assumptions about how the system will accomplish this. This includes defining the role of the human in the system.

In meeting its goal, any system follows a logical scenario of events. Mission scenarios are defined during the Conceptual Phase. Mission definition includes identification of operations during emergency, “off-nominal,” and contingency conditions. As the sequence of events and functional goals are defined, system developers begin to make assumptions and conceptual decisions about how these goals are to be accomplished. Functions can be allocated to possible combinations of hardware, software, and /or humans. These conceptual design decisions involve

making choices about the specific role and duties of the human in the system. To help with these decisions, human factors analysts may analyze critical tasks for each human role option. Techniques for predicting workload and human reliability, and assessing the consequences of task failure, will then be used to help select the optimal human roles in system operations. See Table 3.3-1 for more specific outputs from the Conceptual Phase.

During this phase, human factors personnel will work with a wide variety of project personnel. Establishing the human role requires coordination and tradeoffs with system and design engineers, and with persons and groups responsible for training, mission planning, safety, health, and crew selection.

Finally, during the Conceptual Phase, system developers will develop the set of system-specific requirements necessary to meet NASA-STD-3001, Volume 2.

Handbook Use in Conceptual Phase

The handbook will be used in three ways during the Conceptual Phase:

1. The Conceptual Phase involves defining the human role in the system. The first step is to identify the potential users of the system and describe this population. Chapter 4, “Anthropometry, Biomechanics, and Strength,” discusses how to determine the physical size and capabilities of a crew population.
2. System developers must trade off the use of humans or equipment to accomplish each of the system functions and goals. Doing this requires knowledge of human physical and cognitive capabilities. This information can be found in Chapter 5, “Human Performance Capabilities.”
3. The entire handbook will be used for development of program-specific requirements.

3.3.4 Preliminary Design Phase

During the Preliminary Design Phase, system developers expand on the decisions made during the Conceptual Phase. Basic decisions are made about locations within the system where people will live and work and the type of equipment they will use. The Human Factors group will provide inputs to the habitable volume needs and the overall layout of workplaces and living habitats. Early design will focus on equipment selection, configurations, and procedures that are simple, operable, and consistent throughout the system design. Decisions are also made about habitability and life support system design parameters.

During this phase, human factors analysts will make gross assessments of human activities. They will estimate how many people should be assigned to tasks and estimate task durations. The functional allocations made during the Conceptual Phase will be examined and in some cases revised. During this phase, human factors analysts will use tools including function and task analyses, human anthropometric and cognitive models, physical and virtual models of crew habitation areas and workstations, and preliminary performance and usability testing. Workload and human error assessments made during the Conceptual Phase will be updated and refined during Preliminary Design.

Human factors experts will work closely with system and design engineers and mission planning

groups during the Preliminary Design Phase. This process will be iterative, with design alternatives assessed through tradeoff studies coordinated by system engineers. Also, task analysis data developed by human factors analysts during this phase will be forwarded to training and Mission Planning personnel.

Handbook Use in Preliminary Design Phase

During the Preliminary Design Phase, designers and human factors personnel will use information directly from this handbook. The requirements will have been completed and the handbook will be the resource for fulfilling these requirements. Chapter 8, “Architecture,” describes the considerations to be made and information required for laying out a living and working habitat in space. For extravehicular activities (EVA), Chapter 11, “EVA,” will help designers define preliminary designs for EVA systems. Human environmental support (atmosphere and water) and protection from environmental effects (radiation, contamination, acoustics, acceleration, and vibration) are defined in Chapter 6, “Natural and Induced Environments.”

3.3.5 Final Design and Fabrication Phase

During the Final Design and Fabrication Phase, final dimensioned drawings are made of the user interfaces. Software systems are finalized. It is important that these systems meet the physical and mental needs and capabilities of the crew.

Human factors analysts will perform detailed task analyses and usability testing during this phase. These analyses help to define the details of the system configuration needed to support human performance

and health. This information is communicated to Design Engineering, Crew Selection, and Training personnel. The information developed will include these items:

- Design requirements for details (selection, placement, size) of controls and displays
- Size and configuration of workstations
- Requirements for special environmental support (lighting, ventilation, cushioning, etc.)
- Requirements for labeling
- Skill and training needs of the crew
- Time needed to do tasks (task time)
- Procedures for doing tasks

Design efforts will focus on maximizing crew effectiveness while minimizing training requirements, task time, and errors. This can be achieved through simplifying and standardizing crew interfaces.

Also during this phase, human factors personnel will finalize plans to verify that the system will meet the system-specific human factors requirements defined in the Conceptual Phase.

Handbook Use in Final Design and Fabrication Phase:

Again, the information in this handbook can be used directly by developers to finalize the system configuration. Chapter 4, “Anthropometry, Biomechanics, and Strength,” shows how to design a system that will accommodate the full size range of the selected crew. Chapter 7,

“Habitability Functions,” and Chapter 8, “Architecture,” contain information to help with the detailed design of the crew’s interior physical environment. Chapter 11, “Extravehicular Activity,” defines the detailed design needs for the EVA environment. Chapter 9, “Hardware and Equipment,” and Chapter 10, “Crew Interfaces,” both define detailed configuration requirements for crew interfaces.

3.3.6 Test and Verification Phase

During this phase, the final system configuration is tested to verify that it meets the requirements developed in the Conceptual Phase. In testing human performance or habitability accommodations, the human can be modeled. In some cases, however, modeling does not adequately represent the human, and human test subjects need to be used. Test subjects must be representative of the full range of potential crewmembers in both physical and cognitive aspects. As the responsible agent for the human, human factors personnel must participate in the testing to ensure that it is conducted according to plan, and then interpret the results.

Handbook Use in Test and Verification Phase

Some findings may fall outside predicted norms and various sections of the handbook may have to be consulted for assessment.

3.3.7 Operations, Sustainability, Update, Retrofit, and Closeout Phases

Human factors personnel are often used in standby mode during these phases. These personnel can be a valuable resource in monitoring human performance and feedback. Human factors personnel can help provide immediate solutions (using design data in the handbook) or diagnose situations (using tools such as task analyses and human modeling) and determine where improvements can be made. Some procedural or design changes may be large and may require a more fully developed program with human factors participation as outlined above.

Handbook Use in Operations, Sustainability, Update, Retrofit, and Closeout Phases

The handbook can be used as a resource to assess the severity of crew problems and for determining corrective actions.

Table 3.3-1 HCD in System Design

Phase	Input Info	Human Factors Activities	Output	Focus of Handbook Use During Phase	Coordination With
Conceptual	System goals and basic mission function requirements	Analysis of similar systems Identification of human capabilities and limitations in mission context Operational analyses to define system mission scenarios Allocation of functions to humans or to equipment or software Preparation of Human Factors requirements document Human error and failure consequence analyses	Lessons learned identifying potential problem areas and function allocation guidelines		Design engineering Systems engineering Training Mission planning Safety Health Crew selection
			Mission scenarios and concept of operations		
			Definition of human role in system (job type, basic skill requirements) to help ensure the system is operable	Section 9.13, Design for Training Chapter 5, Human Performance Capabilities	
			Number of crewmembers	Chapter 5, Human Performance Capabilities, Sections 5.6 – 5.8	
			Definition of crew anthropometric characteristics	Chapter 4, Anthropometry, Biomechanics, and Strength	
			Identification of equipment and stations that interface with crew		
			System-specific Human Factors requirements document (including preliminary verification test plans, potential safety issues, and trade studies)	Entire handbook	

Preliminary Design	Defined mission with performance requirements Preliminary exterior boundaries Identification of basic items and areas with which the crew interfaces	Gross task definition and analyses (usability studies of components, prototypes, and mock-ups) Human modeling Empirical testing	Crew duties		Design engineering Systems engineering Mission planning Training Health
			Selection and preliminary design of equipment that interfaces with crew (focus on operability and simplicity)	Chapter 4, Anthropometry, Biomechanics, and Strength Chapter 9, Hardware and Equipment Chapter 7, Habitability Functions Chapter 10, User Interfaces	
			Habitable volume requirements and overall architectural layout	Chapter 8, Architecture Chapter 7, Habitability Functions	
			Detailed environmental support range requirements	Chapter 6, Natural and Induced Environments Chapter 11, EVA	
			Final verification test plans		
Final Design and Fabrication	Basic system layout with crew duties and activity centers defined	Detailed task analyses and usability testing Workload assessment Development testing of human and system performance Provision of input to user interface designs and trade studies based on analyses	Crew skill and knowledge requirements		Design engineering Training Crew selection Mission planning
			Crew organizational behavior requirements	Section 5.8, Crew Coordination and Collaboration	
			Task procedures and times		
			Final crew control, display, and procedure interface designs	Chapter 10, Crew Interfaces	
			Detailed crew workstation and activity center designs	Chapter 7, Habitability Functions Chapter 10, Crew Interfaces Chapter 11, EVA	
			Detailed environmental support requirements defined (lighting, acoustics, ventilation, heating, restraints and padding)	Chapter 6, Natural and Induced Environments Chapter 11, EVA	
Test and Verification	Final system configuration	Conduct and monitoring of Human Factors testing in a complete and integrated system Assessment of results	Test report with recommendations for corrective action if necessary	Entire handbook as required for assessment of test results	Design engineering

Operations and Sustainability, Update and Retrofit, Closeout	Final system configuration User assessments System failure and repair reports	In-situ monitoring of user interface with system Identification of Human Factors problems Task analyses, workload assessment, human modeling as required for retrofit	Solutions to user interface problems	Entire handbook as required	Design engineering
--	---	---	--------------------------------------	-----------------------------	--------------------

3.3.8 Human-Centered Design

HCD, when incorporated into a program’s systems engineering approach, is a process by which end user considerations, limitations, and capabilities are integrated into the design of the product to maximize user performance. An HCD requirement, Human-Centered Design [V2 3005] within NASA-STD-3001, Volume 2, states “Each human space flight program **shall** establish and execute a human-centered design process that includes the following, at a minimum:

- a. Concepts of operation and scenario development
- b. Task analyses
- c. Function allocation between humans and systems
- d. Allocation of roles and responsibilities among humans
- e. Iterative conceptual design and prototyping
- f. Empirical testing, e.g., human-in-the-loop, testing with representative population, or model- based assessment of human-system performance
- g. In-situ monitoring of human-system performance during flight.”

This Agency requirement sets the stage for a program to implement an HCD process to ensure that user considerations, limitations, and capabilities are incorporated into system design. The following discussions break down each of the elements (a through g) that are included within the HCD requirement.

3.3.8.1 Concepts of Operation and Scenario Development

Concept of Operations (ConOps) and mission scenarios are developed by a program to document all mission scenarios and describe how mission objectives are to be accomplished using planned resources, including the crew and the system. The ConOps, developed initially during the conceptual phase, provides a broad view of operations. The ConOps should include the perspective of the users that will ultimately operate the system. As the conceptual phase progresses, the ConOps should evolve to cover all aspects of the system capabilities, including the user.

Table 3.3-2 provides an example of a tool that may be used to develop a ConOps. The table organizes key mission-specific information associated with specific crew activities, such as transit to the International Space Station (ISS). This example describes, at a high level, the planned crew activities for each crewmember for each phase of the mission. The table also identifies subsystems that may be impacted by crew activities. Similar tables can be created for other segments of a mission (e.g., quiescent docked phase, return to Earth, and post-landing) and for off-nominal and emergency scenarios. As a design matures, more information should be provided to capture the specific details associated with each mission phase.

Table 3.3-2 Example Nominal Scenario – Travel to ISS (Notional)

Mission Phase	Crew Activities					Subsystems Impacted
	Crew 1	Crew 2	Crew 3	Crew 4	Crew 5	
Vehicle Boarding	Ingress in suit	Ingress in suit	Ingress in suit	Ingress in suit	Ingress in suit	Architecture, environmental, monitoring, lighting
Launch Prep	Check procedures	Check procedures	N/A	N/A	N/A	Environmental, monitoring, lighting, windows, controls/displays
Launch	Check procedures	N/A	N/A	N/A	N/A	Environmental, monitoring
Ascent	Check procedures	Eat Waste Sleep	Eat Waste Sleep	Eat Waste Sleep	Eat Waste Sleep	Architecture, environmental, monitoring
Orbit	Eat Waste Sleep	Eat Waste Sleep	Eat Waste Sleep	Eat Waste Sleep	Eat Waste Sleep	Architecture, environmental, monitoring, hygiene, stowage, & trash
Proximity Operations	Check procedures	Check procedures	N/A	N/A	N/A	Environmental, monitoring, lighting, windows, controls/displays
Rendezvous	Check procedures	Check procedures	N/A	N/A	N/A	Environmental, monitoring, lighting, windows, controls/displays
Dock/Berth	Check procedures	Check procedures	N/A	N/A	N/A	Architecture, environmental, monitoring, lighting, windows, controls/displays

3.3.8.2 Task Analysis

Task analysis is a methodology used to break down an event, such as vehicle boarding (example from Table 3.3-2), into individual tasks, and to break down individual tasks into simpler components. The focus of a task analysis is on humans and how they perform the task, rather than on the system. The methodology is used to understand and thoroughly document how tasks are to be accomplished. Results can help determine the displays or controls that need to be developed and used for a particular task, the ideal allocation of a task to humans vs. automation, and the criticality of a task, which all help drive design decisions. As a means to understand the goals and operations of a vehicle, a high-level task analysis should be performed early in vehicle design. Early definition of tasks and task analysis occurs during the conceptual phase when mission, operations, and requirements are refined and clarified. Task definitions and descriptions continue to evolve as designs, ConOps, and crew utilization/functional allocation are determined. As the task-related products mature, the focus shifts to defining the lower-level crew to system interactions (physical and cognitive activities) that the vehicle needs to accommodate for successful mission completion. Common techniques for gathering task analysis data include: documentation review, surveys, questionnaires, interviews, observations, and verbal protocols.

As stated earlier, a task analysis involves defining the physical and cognitive (including perception [e.g., visual, tactile, and auditory], decision-making, comprehension, and monitoring) tasks that are to be performed. In addition, pertinent task attributes are also captured and documented. These task attributes include:

- User roles and responsibilities
- Task sequence
- Task durations and frequencies
- Environmental conditions
- Necessary hardware, clothing, and equipment
- Constraints or limiting factors
- Necessary user knowledge, skills, abilities, and/or training

Documenting the physical and cognitive tasks and the associated/supporting information should be completed for all functions allocated to users for the established mission objectives, phases, and scenarios. To make the task analysis activity as useful as possible, representatives from the user population should be involved in task analysis activities. Having representatives from the user population participate provides an opportunity for that community to share its experiences and expectations throughout the design process.

3.3.8.3 Function Allocation between Humans and Systems

A function allocation formulates a functional description of a system and of the allocations of functions among users and system components. A function allocation significantly influences design decisions by establishing which functions are to be performed by the users and which by the system. Based on the ConOps, function allocation determines the extent to which a given activity, task, function, or responsibility is to be automated, assigned to the user, or assigned to

some other asset (like a remote operator). Function allocation is based on many factors, including the relative capabilities and limitations of the user and the technology in terms of reliability, speed, accuracy, strength, flexibility of response, financial cost, the importance of successful or timely accomplishment of tasks, and user well-being. Decisions should not be based on determining which functions technologies are capable of performing and then simply allocating the remaining functions to users, relying on the user's flexibility to make the system work. The outcome can lead to user inattention and job dissatisfaction.

To conduct a function allocation, an initial task analysis should be consulted to determine what tasks are necessary to accomplish the goal of the system. Next, tasks that are more suited for a computer – such as persistent monitoring and/or performing large complicated calculations, and which are better for a human to complete – should be identified. This involves considering the strengths and limitations of the user and the general conditions of the situation. General things to consider include whether there are concurrent tasks, the time criticality of the task, the workload associated with the task, the need for specialized knowledge, etc. The responsibility for a task needs to be allocated to the component (human or machine) that is most capable of accomplishing the goal of the system. This ensures that the user has an acceptable workload during most interactions with the system, thereby leading to an increase in system performance.

Function allocation and task analysis should continue iteratively throughout the design lifecycle. As one becomes more detailed, assessment of the other for accuracy and completeness is required. Testing may be used to assess the accuracy of the allocations and determine whether any changes need to be made. Function allocations evolve as system capabilities, including the user, become better defined through iterative HCD process.

Human reliability analysis can also inform function allocation (such as with ISS emergency responses). When a failure is complex, an adaptable human may be more capable of a successful response than a machine.

3.3.8.4 Iterative Conceptual Design and Prototyping

Candidate design solutions are visualized through graphical or physical representations (prototypes) based on information gathered through ConOps, task analysis, and function allocation activities. Design concepts may be communicated in many forms, depending on the maturity of the design, and may range from paper and pencil sketches, to interactive prototypes, to high-fidelity mock-ups or computer-based simulations. During this activity, it is important to communicate ideas and involve the user in focused design reviews or evaluations to gather feedback. Designs and their physical representations are iteratively improved based on user feedback and evaluation results until acceptable solutions are achieved.

3.3.8.5 Empirical Testing (Design Evaluation and Iteration)

Within an iterative design process, evaluation activities evolve designs by identifying areas for design improvement through the gathering of quantitative and qualitative data. Evaluation of design concepts and alternatives is crucial to achieving optimal design solutions. Evaluations must begin early and continue throughout an iterative system design process. They can include a wide variety of activities, progressing in fidelity as the design progresses, from activities such as initial

informal reviews with SMEs and/or users to formal usability tests, human-in-the-loop (HITL) testing, or flight simulations gathering quantitative performance data or qualitative observations to assess things such as habitat layout, design of displays and controls, vehicular handling qualities, and vehicle controllability by pilots. Collection of objective, quantitative data is preferred to collection of subjective, qualitative data, understanding that this progresses as the design progresses. It is imperative to use representative users in the simulations and evaluations to ensure that results capture the capabilities of the user and are relatable to the mission situations.

Fidelity and integration of evaluations increase with maturation of the design. Early in the design, single-system or even single-component evaluations are performed. However, as the design matures, evaluations also mature to include entire subsystems, systems, and eventually integrated systems. Increases in fidelity include maturations such as progressing from Computer-Aided Design (CAD) analyses to HITL evaluations in a flight simulator, increasing the flight representation of the hardware, increasing from qualitative to quantitative data collection, and/or increasing the representativeness of the user sample. High-fidelity evaluations should be conducted later in the design lifecycle.

Evaluations need to focus on specific objectives, and evaluation plans need to be developed to include details such as:

HCD goals

Parts of the system to be evaluated and the fidelity of hardware and software (e.g., use of computer simulations, mock-ups/prototypes, test scenarios, etc.)

How the evaluation is to be performed (test set up, methodology, etc.) The procedures to be used in the evaluation

Resources required for evaluation and analysis, including users/test subjects

Scheduling evaluation activities and resources, including users/test subjects and concrete design proposals (e.g., models, simulations, mock-ups, etc.)

Intended use of results/feedback

An HITL evaluation is formulated, structured, and executed based on critical questions (objectives) and collection of measurements that lead to answering those questions. Critical questions that need to be answered are determined with stakeholder input, and the evaluation is structured by scientists or human factors professionals using research methods and rigorous experimental design to answer the questions set forth. For example, if two hardware designs need to be tested (compared), then an optimal test set up may include counterbalancing of hardware assessment order for a repeated measures analysis or blocking of the hardware design for a between-subjects analysis, collection of error rates for a quantitative performance measure, and collection of subjective workload ratings for a qualitative measure. The quantitative measure of performance can differentiate the designs objectively, whereas the qualitative measure allows for subject expertise, experience, and preference measures. The structure and rigor of an evaluation ensures that the results are valid and that proper information is available to make design decisions.

Evaluation findings are used to assess and reassess the understanding of the human-systems relationship and appropriateness of design solutions in an iterative, feedback loop. Therefore, as

designs mature, each successive evaluation should mature and be performed with more complete and flight-representative inputs and outputs, simulations, or hardware (e.g., mock-ups, qualification units, etc.). Intentional design iteration is a fundamental principle of HCD. In addition to ensuring an appropriate and usable design, design evaluation early and often contributes to lifecycle development cost control by helping to identify risks and issues early in the design cycle when they are relatively inexpensive to fix. Usability evaluations, task analyses, and function allocations are conducted, or reexamined, several times during the early stages of the system lifecycle. Results should have a direct influence on system design, providing continuous feedback to the designers of the system.

3.3.8.6 Allocation of Roles and Responsibilities among Humans

In conjunction with a function allocation and task analysis, the tasks that have been allocated to humans need to be distributed between the expected users (i.e., crewmembers), where some users have different responsibilities than other users. As an example, consider the responsibilities of a commander, pilot, and physician. System designers need to understand the capabilities of the various users and consider the assignment of tasks and when the tasks are expected to be completed by the various users during the systems development process.

Allocation of roles and responsibilities needs to include consideration of task timing, number of crew required, available space and time, privacy needs, information required, and other pertinent constraints.

3.3.8.7 In-situ Monitoring of Human-Systems Performance during Flight

Task analyses, function allocation, evaluation, and model-based assessment are all useful tools used to impact system design, aid in understanding how a human will interact with the system, and identify problems that hinder overall system performance. However, these tools are used only through the design process. In-situ monitoring occurs during mission operations and is key to understanding human- systems performance during flight.

In-situ monitoring is intended to provide data in support of system adjustments, during flight, that increase safety and performance. This capability is particularly important for systems that support life such as environmental control systems that maintain air and water quality. These data allow real-time operators to make modifications to ensure mission goals are achieved, as well as provide feedback to inform design changes for future flights.

TABLE of CONTENTS

4	ANTHROPOMETRY, BIOMECHANICS, AND STRENGTH	38
4.1	INTRODUCTION	38
4.2	GENERAL	38
4.2.1	Introduction	38
4.2.2	User Population	39
4.2.2.1	Selection and Validation of a Database	39
4.2.2.1.1	Example of Databases	40
4.2.2.2	Growth Trend	41
4.2.3	Methods for Accommodating Physical Dimensions	43
4.2.4	Population Analysis	44
4.2.4.1	Multivariate Anthropometric Analysis	44
4.2.4.2	Enhancement of Human-in-the-Loop Testing	45
4.2.5	Selection and Calculation of the Size of the User Population	46
4.2.5.1	Selecting a User Population Size Range	46
4.2.5.2	Estimating Percentiles from Anthropometric Data	46
4.2.6	Research Needs	47
4.3	ANTHROPOMETRY	48
4.3.1	Introduction	48
4.3.2	Anthropometry Data	48
4.3.3	Application of Anthropometry to Designs	49
4.3.3.1	Process for Accommodating Anthropometry in a Design	50
4.3.3.1.1	Clearance	50
4.3.3.1.2	Reach or Access	50
4.3.3.2	Things to Remember When Applying Anthropometric Data	51
4.3.3.3	Factors That Affect Anthropometry	53
4.3.3.3.1	Age Effects	54
4.3.3.3.2	Gender Effects	54
4.3.3.3.3	Clothing Effects	55
4.3.3.3.4	Pressurization Effects	55
4.3.3.3.5	Postural Effects	56
4.3.3.3.6	0g Effects	56
4.3.3.3.7	Hypergravity Effects	60
4.3.4	Anthropometric Data Collection	60
4.3.5	Research Needs	61
4.4	RANGE OF MOTION	62
4.4.1	Introduction	62
4.4.2	Application of Range-of-motion Data to a Design	64
4.4.2.1	Workstation Design and Layout	64
4.4.2.2	Design of Personal Clothing and Equipment	64
4.4.2.2.1	Sample Task Range of Motion to Use When Designing Personal Clothing and Equipment	65
4.4.3	Factors That Affect Range of Motion	66
4.4.3.1	Body Size	66
4.4.3.2	Age Effects	66

4.4.3.3	Gender Effects	66
4.4.3.4	Other Individual Effects	66
4.4.3.5	Multi-Joint Versus Single-Joint Effects	67
4.4.3.6	Clothing Effects	67
4.4.3.7	Pressurization Effects	67
4.4.3.8	Postural Effects	67
4.4.3.9	Gravity Effects	67
4.4.3.9.1	Hypergravity Effects	67
4.4.3.10	Restraint Effects	68
4.4.4	Collection of Range-of-motion Data	68
4.4.5	Research Needs	69
4.5	REACH ENVELOPE	70
4.5.1	Introduction	70
4.5.2	Reach Envelope Data	70
4.5.3	Application of Reach Envelope Data	73
4.5.3.1	Establishing Boundaries	73
4.5.3.2	Criticality of Operations	73
4.5.3.3	Restrictions	73
4.5.4	Factors That Affect Reach Envelope	73
4.5.4.1	Body Size	73
4.5.4.2	Age and Gender Effects	73
4.5.4.3	Clothing and Pressurization Effects	74
4.5.4.4	Postural Effects	75
4.5.4.5	Gravity Effects	75
4.5.4.6	Restraint Effects	75
4.5.5	Collection of Data	75
4.5.6	Research Needs	76
4.6	BODY SURFACE AREA, VOLUME, AND MASS PROPERTIES	77
4.6.1	Introduction	77
4.6.2	Body Surface Area	77
4.6.2.1	Body Surface Area Data	77
4.6.2.2	Calculation Procedure	77
4.6.2.3	Application of Body Surface Area Data	77
4.6.2.4	Factors That Affect Body Surface Area	78
4.6.2.5	Body Surface Area Data Collection	78
4.6.3	Body Volume	78
4.6.3.1	Body Volume Data	78
4.6.3.2	Application of Body Volume Data	79
4.6.3.3	Factors That Affect Body Volume	79
4.6.3.4	Body Volume Data Collection	79
4.6.4	Body Mass Properties	80
4.6.4.1	Whole-Body and Body-Segment Mass	80
4.6.4.1.1	Data for Whole-Body and Body-Segment Mass	80
4.6.4.1.2	Application of Whole-Body and Body-Segment Mass Data	81
4.6.4.1.3	Factors That Affect Whole-Body and Body-Segment Mass	81

4.6.4.2	Whole-Body and Body-Segment Center of Mass	81
4.6.4.2.1	Data for Whole-Body Center of Mass.....	81
4.6.4.2.2	Data for Body Segments' Center of Mass.....	82
4.6.4.2.3	Application of Whole-Body and Body-Segment Center-of-Mass Data.....	83
4.6.4.2.4	Factors That Affect Whole-Body and Body-Segment Center of Mass	83
4.6.4.3	Whole-Body and Body-Segment Moment-of-Inertia Data.....	83
4.6.4.3.1	Data for Whole-Body Moment of Inertia.....	83
4.6.4.3.2	Data for Body-Segment Moment of Inertia	84
4.6.4.3.3	Application of Whole-Body and Body-Segment Moment-of-Inertia Data.....	85
4.6.4.3.4	Factors That Affect Whole-Body and Body-Segment Moment of Inertia.....	85
4.6.5	Research Needs	85
4.7	STRENGTH.....	86
4.7.1	Introduction	86
4.7.2	Strength Data Presentation	86
4.7.3	Application of Strength Data	87
4.7.3.1	Maximum or Minimum Data	87
4.7.3.2	Criticality of Operations.....	87
4.7.3.3	Other Factors to Consider in Application of Data.....	87
4.7.4	Factors That Affect Strength Data.....	87
4.7.4.1	User Population	87
4.7.4.2	Activity Type.....	87
4.7.4.3	Anthropometry	88
4.7.4.3.1	Age Effects	88
4.7.4.3.2	Gender Effects.....	88
4.7.4.3.3	Clothing Effects	88
4.7.4.3.4	Postural Effects	89
4.7.4.3.5	0g Effects.....	89
4.7.4.3.6	Hypergravity Effects	89
4.7.4.3.7	Counter reactive Forces.....	90
4.7.4.3.8	Restraints.....	90
4.7.4.3.9	Deconditioning Effects.....	90
4.7.4.4	Collection of Data	91
4.7.5	Research Needs	92
4.8	REFERENCES	93

TABLE of FIGURES

Figure 4.2-1. Mean Male Stature Example	42
Figure 4.3-1. Sample of Commonly Provided Anthropometric Dimensions.....	49
Figure 4.3-2. Neutral Body Posture in 0g	59
Figure 4.4-1. Illustrations of Measured Motion Range.....	64
Figure 4.5-1. Side Reach Horizontal Planes	71
Figure 4.5-2. Example of Reach Envelope Data in the Horizontal Plane.....	72

TABLE of TABLES

Table 4.2-1.	Values of Z for Selected Percentiles.....	47
Table 4.3-1.	Lack of Correlation among Common Measurements.....	52
Table 4.3-2.	Operating Environment Values of Factors Affecting Anthropometric Dimensions.....	54
Table 4.3-3.	Spacesuit (Unpressurized and Pressurized) Effects on Anthropometry	56
Table 4.3-4.	Anthropometric Changes in $0g$	58
Table 4.3-5.	Neutral Body Posture and Clearance Envelope.....	60
Table 4.4-1.	Select Minimum Joint Range of Motion to Perform Functional Tasks with the Upper Body	65
Table 4.4-2.	Select Minimum Joint Range of Motion to Perform Functional Tasks with the Lower Body.....	65
Table 4.4-3.	Select Normal Joint Range of Motion during Walking Gait.....	66
Table 4.4-4.	Reach Movements Possible in a Multi-g Environment.....	67
Table 4.5-1.	Change in Body Envelope Data when Measured after Donning Liquid	74
Table 4.6-1.	Estimated Body Surface Area of the Crewmember.....	77
Table 4.6-2.	Whole-Body Volume of Male and Female Crewmembers	78
Table 4.6-3.	Select Body-Segment Volumes of Male and Female Crewmembers.....	79
Table 4.6-4.	Whole-Body Mass of Crewmember	80
Table 4.6-5.	Select Body-Segment Mass Properties for Male and Female Crewmembers	81
Table 4.6-6.	Whole-Body Center-of-Mass Location of Male and Female Crewmembers.....	82
Table 4.6-7.	Select Body-Segment Center-of-Mass Locations of Crewmembers.....	83
Table 4.6-8.	Whole-Body Moment of Inertia of the Crewmember	84
Table 4.6-9.	Select Body-Segment Moment of Inertia of the Crewmember	85
Table 4.7-1.	Examples of Strength Data Tables	86
Table 4.7-2.	Common approaches to strength data collection.....	88
Table 4.7-3.	Effect of Wearing a Pressurized Suit on Maximum Voluntary Torque	89
Table 4.7-4.	Effects of Spaceflight and Bed Rest on Strength	91

4 ANTHROPOMETRY, BIOMECHANICS, AND STRENGTH

4.1 INTRODUCTION

It is important to design spacecraft, spacesuits, and the equipment used therein, to accommodate the physical size, shape, reach, range of motion, and strength of the selected user crewmember population. Adjustments for the effects of external factors (e.g., gravity environments, clothing, pressurization, deconditioning due to mission duration) on crewmember anthropometry, biomechanics and strength must be included in the spacecraft design.

This chapter discusses the physical dimensions of humans and how to use this information to support the design of hardware to accommodate the full range of selected users and their physical qualities. The following physical dimensions are addressed:

- Physical Dimensions or Anthropometry
- Range of Motion
- Reach Envelope
- Body Surface Area
- Body Volume
- Body Mass

Section 4.3 provides an overview of factors that affect anthropometry, collecting anthropometric data from subjects, and proper application of the data. Section 4.4 presents considerations and design requirements for joint range of motion. Section 4.5 discusses human physical reach considerations and design requirements. Section 4.6 covers human body surface area, volume, and mass properties based on body mass properties. Section 4.7 presents information about human strength capabilities.

Further, this chapter provides information on how to develop and use human body dimension and strength data. The chapter does not provide specific data. Programs must develop their own dimensional dataset based on the selected user population, including any estimates or assumptions made relating to that population. Where they may be helpful, the sections below give examples of calculations and applications. The data provided in the examples is from a database developed specifically for NASA's Constellation program. The entire Constellation program database is in Appendix B. Also in Appendix B is a full example set of reach dimensional data extracted from NASA-STD-3000. The data in the appendices is primarily for example purposes and is not meant to apply to all NASA programs.

4.2 GENERAL

4.2.1 Introduction

This section describes general considerations for identifying the user population and methods of translating this population into dimensional data to be used in designs of hardware and systems to accommodate the user population.

4.2.2 User Population

One of the most important considerations in human-centered design is the user population. The question of who will be using the hardware must be addressed.

Choosing the user population is a very important consideration because it is a major driver in the overall design and operations of spacecraft as well as the equipment used. It is especially important to determine the range of critical dimensions or values that are significant to overall layout and design of the spacecraft and key equipment used such as couches and spacesuits.

Users should be defined in terms of age, gender, ethnicity, and other special considerations. This information is critical for selecting an appropriate database. Special considerations may include level of physical fitness. A user population of military personnel, for example, usually has a physical fitness level different from a user population of civilians. Other considerations might include the timeframe for hardware use. If hardware is intended to be used far into the future, this may affect the anthropometry needs, because attributes of populations tend to change over time (discussed further in section 4.2.2.2).

4.2.2.1 Selection and Validation of a Database

The selection of a database for use in the design of any type of hardware is dictated by the potential user population. The database needs to be appropriate for subject age, gender, and factors such as physical condition or other special considerations.

Though it may be ideal to collect data for each subject who will use a piece of hardware, it is rarely feasible to do so. Thus, the selection of a database that closely represents the expected user population is crucial to good ergonomic design.

A variety of published adult anthropometry data is available for use. Resources commonly used throughout ergonomic and human factors industries are shown below.

- 1988 Anthropometric Survey of US Army Personnel (ANSUR)
- Air Force surveys
- National Health and Nutrition Examination Survey (NHANES; Ogden, et al., 2004)
- Civilian American and European Surface Anthropometry Resource (CAESAR)

Although NASA maintains databases of astronaut anthropometry, this data is not necessarily the best estimate for future astronauts. While it may be useful for current and ongoing human factors analyses and investigations, it may not fully represent the variation among the population from whom the astronauts are selected. Also, the astronaut selection standards may change over time. Another problem is that the number of subjects in the astronaut databases is relatively small, especially for females. Therefore it is necessary to select a suitable database that is (a) current, (b) large enough to overcome statistical issues, and (c) representative of the anticipated user population. Thus, sources such as modified military or civilian databases may be more appropriate representations of a future astronaut population.

Various methods exist to adjust existing databases to better represent a user population. For instance, databases may be truncated to include only people of a specific gender, age, or ethnicity. Databases may also be combined to include a more diverse population. Finally,

populations may need to be adjusted by means of algorithms to indicate changes over time or between populations (see section 4.2.2.2).

To validate that the selected anthropometric database (for example, the ANSUR or CAESAR database) is the proper one to represent the user population of interest, the analyst must address the following two questions:

- 1) Does the database represent who will use the system?

Consider the following factors when answering this question:

- Age – NASA-STD-3000 (Man-Systems Integration Standards [MSIS], 1995) assumes an average crew age of 40 years.
- Ethnic origin – This should match the population from which the crew is being selected.
- Gender – Crews are always mixed gender. In most anthropometric dimensions, the female is smaller than the male. Therefore, a size range will span from the smallest female to the largest male.
- Physical fitness – Crewmembers are generally considered to be more fit than the general population. This makes military data a more valuable and appropriate resource than data from the general population.
- Education level – Crewmembers generally have postgraduate degrees, and, if possible, the database of interest should be screened for this criterion.

- 2) Is there a sufficient number of subjects in the database?

Collection of anthropometric data for a population is a large undertaking and not normally part of a system's development effort. System developers normally rely on data from surveys funded by large organizations. These surveys are sufficiently large (at least 1000 subjects) to account for population variances.

4.2.2.1.1 Example of Databases

For the International Space Station (ISS) program, NASA defined its user population to include people from a variety of international backgrounds. In general, Japanese females were considered to be the smallest potential users, with American males considered to be the largest.

Design standards and the extreme limits as defined by the current crewmember selection should be compatible. In NASA-STD-3000, design criteria were set at 5th-percentile Japanese female and 95th-percentile American male as the extremes. However, a review of past crew selections indicates that crewmembers exhibit anthropometric characteristics well beyond those of 5th-percentile Japanese female and 95th-percentile American male. Therefore, if astronaut selection and screening standards were to remain the same, a broader range of user population must be considered for design of future hardware to accommodate the crew. Specifically, new design standards should encompass the extreme limits as defined by the current crewmember selection.

The NASA Constellation program standards estimate the age (males and females aged 35-50 years) and dimensions of the NASA astronaut Constellation system user population in the year 2015. The dimensions are based on a military database adjusted to represent the astronaut population in the year 2015. A military database was selected to better represent the anthropometry of the astronaut population, because the obesity rate of civilian databases outpaces the foreseen obesity rate of an astronaut population.

A database for the NASA astronaut Constellation system user population is in Appendix B (*Constellation Program Human-Systems Integration Requirements*, CxP 70024 Rev. B, 2007).

4.2.2.2 Growth Trend

Past experience indicates that historical changes have occurred in anthropometric dimensions such as height, weight, and other physical measurements. These changes that occur from generation to generation are referred to as secular change, and the impact of such changes can be significant for hardware design.

To predict secular change, the first step is to select a population that is representative of the future user of the system under development. A database of dimensions should exist for this population. Next, use trend analysis to estimate the stature of a future user population. Finally, use the estimated future stature and the relationships between stature and other dimensions (including mass, body volume, and surface area) to calculate estimated future body segment lengths and other needed dimensions.

This procedure is described in step-by-step detail below (Tillman and McConville, 1991). The steps include example calculations using the year 2015 NASA astronaut data.

1. Select a population that is similar to the anticipated user population and for which data for stature over several decades is available. Ideally, the population should be similar to the crew population in both ethnic mix (world population sizes differ significantly) and level of fitness (the ratio of body stature to mass is important – see step 3). Plot the average stature and determine a trend. Project the mean stature to the desired future date.

One source of growth trend data for the United States population is published by the Centers for Disease Control from the National Health and Nutrition Examination Surveys that they conduct approximately every 10 years. For example, Figure 4.2-1 shows the mean (i.e., 50th percentile) stature growth data for the American male. As can be seen, growth seems to be leveling off at 69.5 in., and a reasonable estimate of American male stature in 2015 would be 69.5 in. Using the same trend data and the male astronaut population data (adapted from Air Force surveys), the mean stature is estimated to be 70.3 in. in 2015.

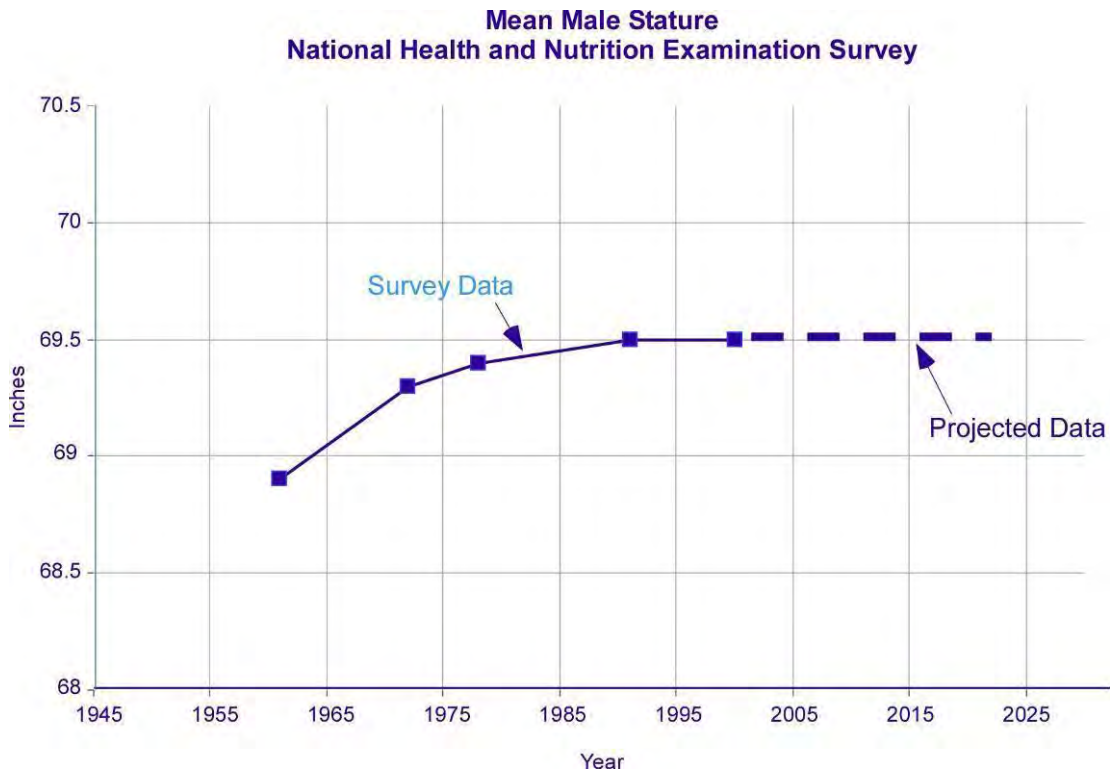


Figure 4.2-1 Mean Male Stature Example

- For the population similar to the anticipated future system user, use the database to create linear regression equations for the mean of each body length dimension based on mean stature and body mass (“weight”).

The equations will be in the following format:

$$\text{Dimension D} = A \times S + B \times W + C$$

where S is stature and W is whole body mass. A, B, and C are regression equation constants developed from the original dataset.

The data in Appendix B is based on linear regression equations created from the 1988 U.S. Army Anthropometric Survey (ANSUR) of approximately 4000 soldiers (Gordon et al., 1988).

- Estimate the future mean weight for the population by assuming a constant ratio between stature and weight and using the estimated future mean stature.

For example, if the mean weight in the baseline dataset is W_{now} and the stature is S_{now} , then to estimate future weight (W_{future}), we can use the following relationship:

$$S_{\text{now}} / W_{\text{now}} = S_{\text{future}} / W_{\text{future}}$$

and

$$W_{\text{future}} = W_{\text{now}} (S_{\text{future}} / S_{\text{now}})$$

The mass examples from Appendix B are based on an estimate of 181.6 lb (82.4 kg) for the mean male weight in the year 2015.

- Calculate the mean dimensions of the projected population using the regression equations developed in Step 2.

For example, using the regression equation constants derived from the ANSUR database, the mean waist height for the 2015 male would be calculated as follows:

$$\text{waist height (mean for 2015 male)} = 0.72 \times S_{\text{future}} - 0.39 \times W_{\text{future}} - 203.38$$

(for units in mm and grams)

Therefore,

$$\text{waist height (mean for 2015 male)} = 0.72 \times 1785.6 - 0.39 \times 82.4 - 203.38 = 1050.1 \text{ mm or } 105.01 \text{ cm}$$

The “goodness of fit” or correlation coefficient for this dimension is 0.827. The predictability is better for some dimensions than others.

- Determine the projected standard deviation for each dimension by assuming a constant ratio of standard deviation to mean stature for each dimension:

$$SD_{\text{dimension D now}} / \text{Stature}_{\text{now}} = SD_{\text{dimension D future}} / \text{Stature}_{\text{future}}$$

and

$$SD_{\text{dimension D future}} = SD_{\text{dimension D now}} \times (\text{Stature}_{\text{future}} / \text{Stature}_{\text{now}})$$

In our example, this would be

$$SD \text{ for waist height of 2015 male} = 2.65 \times (1.019) = 2.70 \text{ cm}$$

- Assume a normal distribution for calculation of projected dimensions for other percentiles. For example, 1st- and 99th-percentile values are calculated using the following equation:

$$1^{\text{st}}\text{- or } 99^{\text{th}}\text{-percentile dimension Value}_{\text{future}} = (\text{mean value for dimension D}_{\text{future}}) \pm 2.33 \times (\text{standard deviation for dimension D}_{\text{future}})$$

For the year 2015,

$$\text{standard deviation for dimension D}_{\text{future}} = 6.27 \text{ cm}$$

and

$$99^{\text{th}}\text{-percentile male waist height} = 105.01 + 2.33 \times (6.27) = 119.61 \text{ cm}$$

See section 4.2.5 for an explanation of the calculation of percentiles.

- Knowing the body mass and stature of the anticipated user population, it is possible to calculate estimates for body segment mass, moment of inertia, and surface area (see section 4.6).

4.2.3 Methods for Accommodating Physical Dimensions

Once the user dimensions are determined, the system or hardware must be designed to those dimensions. Three general methods for doing this are described below:

- Single solution for all – In the case of anthropometry, a single size may accommodate all members of the population. For example, usually if a workstation has a switch located within

the reach limit of the smallest person, everyone will be able to reach the switch. In the case of strength, setting the strength requirement at or below the capability of the weakest person will allow everyone to successfully exert effort without exhausting themselves.

2. Adjustment – The design can incorporate an adjustment capability. A common anthropometric example of this is the automobile seat. A common strength example is the setting up of resistance variations on an exercise device, enabling various resistance options for different users.
3. Several solutions – Several sizes of equipment may be required in order to accommodate the full population size range. This is usually necessary for equipment or personal gear that needs to closely conform to the body, such as clothing and spacesuits.

All three methods require the designer to use appropriate anthropometric, biomechanics, and strength data.

4.2.4 Population Analysis

Accommodating a widely varying user population presents a challenge to engineers and designers. It is often difficult to even quantify who is accommodated and who is not accommodated by designs, especially for equipment with multiple critical anthropometric dimensions. One approach to communicating levels of accommodation, referred to as “population analysis,” applies existing human factors techniques in novel ways.

The major applications of population analysis are providing accommodation information for multivariate problems and enhancing the value of feedback from human-in-the-loop testing or performance modeling. The results of these analyses range from the provision of specific accommodation percentages of the user population to recommendations of design specifications.

Ultimately, the benefit of population analysis is to use an analytical approach and test methodologies to determine a) whether the intended design would accommodate the entire range of population and b) in the event it does not, what extremes a design concept can accommodate.

4.2.4.1 Multivariate Anthropometric Analysis

Through analyzing multiple variables simultaneously, it is possible to take understanding beyond one-dimensional percentiles. It is relatively simple to place data into context for one-dimensional cases. For example, the height of a doorway can be based on stature. The door should be designed so that the tallest expected user can walk through it upright. If the height of the doorway is equivalent to 90th-percentile male stature, it can be deduced that approximately 10% of males in that population will have difficulty traversing the doorway.

However, it may also be necessary to determine an appropriate width for the doorway. This should be based on anthropometry as well, with the largest expected bideltoid breadth (shoulder breadth) as an example of a possible appropriate minimum width. If the width of the doorway is 90th-percentile male bideltoid width, approximately 10% of the male population will not be accommodated due to this dimension.

The trouble in defining accommodation arises when the height and width dimensions are taken into account simultaneously. For instance, combining the two previous examples, since stature and bideltoid breadth are not highly correlated it would be inaccurate to conclude that 10% of the

total population cannot use the doorway. The group of individuals that is not accommodated due to stature may share some members with the group that is not accommodated due to bideltoid breadth, and thus somewhere between 10% and 20% of the population will not be accommodated.

Through analysis of a sample database of population anthropometry, it is possible to determine a reasonable estimate of the percentage of the population that will not be accommodated in this simple example of a multivariate problem. The methodology for such an analysis is as follows:

1. Determine critical dimensions for accommodation specific to the task. In the doorway example, these dimensions are stature and bideltoid breadth.
2. Select an appropriate database to represent the user population.
3. Identify the extreme values of the critical dimensions that can be successfully accommodated. For clearance problems such as the doorway, any values smaller than the size of the doorway can be accommodated. If the task involves reaching, smaller dimensions may not be accommodated. In the doorway example, the height was determined to be equivalent to 90th-percentile male stature, and the width was determined to be equivalent to 90th-percentile male bideltoid breadth.
4. Filter the user population database through the critical dimension values selected. For each subject in the database, test to determine if the subject falls within the accommodated range for all critical dimensions. In the doorway example, for a subject to be considered successfully accommodated, both the subject's stature and the subject's bideltoid breadth must be less than the 90th-percentile male value for each dimension. The estimated percent accommodation for the user population is the percentage of the database remaining after any subjects who fall outside the accommodated range are filtered out.

4.2.4.2 Enhancement of Human-in-the-Loop Testing

Subject feedback becomes more valuable when it is examined in the context of the population as a whole. For example, subjective performance ratings can serve as valuable tools, and a subject may be asked to rate the difficulty of walking through the doorway suggested in the previous example. The subject may indicate that the doorway was completely acceptable. Perhaps a group of 10 subjects walks through the doorway and agrees that the doorway is completely acceptable.

Taken alone, these results might encourage designers to believe that the dimensions are appropriate for the population as a whole. However, it is imperative to consider the statures and bideltoid breadths of the subjects who provided these ratings. If the largest stature tested was 55th-percentile male and the largest bideltoid breadth tested was 60th-percentile male, then a conclusion, based on all positive ratings, that the dimensions were acceptable for larger subjects would be unfounded.

On the other hand, if the largest subjects tested met or exceeded the largest expected user, the positive user feedback could be valuable. This would indicate that the extremes of the population were in fact tested, and thus the feedback represents the predicted worst-case scenario.

Even for simple pass-fail tests, such as observing whether a subject is able to walk through the doorway without colliding with the frame, comparing the subject's dimensions to the user population's dimensions brings power to the evaluation that would otherwise not be present. The following are some suggested steps for use of population analysis for human-in-the-loop testing:

1. Determine the critical dimensions for accommodation specific to the task.
2. Select an appropriate database to represent the user population.
3. Calculate the percentile values for all critical dimensions of each test subject (see section 4.2.5 for information about the calculation of percentiles).
4. Compare the anthropometry of the test subjects to the expected extreme values to be accommodated.
5. Place subjects in the context of the population for all analyses that include their subjective feedback.

4.2.5 Selection and Calculation of the Size of the User Population

4.2.5.1 Selecting a User Population Size Range

The size range of the user population must be selected for each program, with the following considerations:

- A broad range may make it more difficult for designers, and the system could be more expensive: seat adjustments may have to be greater, body supports may have to be more structurally sound for heavier individuals, hatches might have to be larger, and so on.
- A narrow range will limit the population that can use the system. Valuable human resources (skills and abilities) may have to be rejected because the design will not accommodate a broad population range.

No matter which population range is selected, system developers must consider the implications of not accommodating users who are outside of the design limits. One option would be to change the limits. Further, it is important to pick the dataset that is closest to the user population.

4.2.5.2 Estimating Percentiles from Anthropometric Data

When estimating percentiles from a large population, a percentile is defined as the value of a variable (or measure) below which a certain percentage of observations fall. Our research has shown and corroborated that most anthropometric measures will follow a normal distribution. The term “percentile” is often used in the reporting of values from a norm-referenced database, such as the ANSUR database. Further, when estimating percentiles from an anthropometric database, the data is represented graphically as a normal curve. At the peak of the normal curve, in the center, stands the mean (i.e., 50th percentile) and median of the distribution being graphed. The mean (μ) and standard deviation (σ) define a normal distribution, and can be used to calculate percentiles.

The p^{th} percentile can be estimated by the percentile equation: $X_{(p)} = \mu + \sigma(z)$.

Values of Z are constant for a given percentile and can be found in a standard normal (Z) distribution table. See Table 4.2-1 for example values of z for selected percentiles. Complete Z tables can be found in the appendix section of most statistics books.

Table 4.2-1 Values of Z for Selected Percentiles

p	z	p	z
1	-2.33	99	2.33
5	-1.64	95	1.64
10	-1.28	90	1.28

An example percentile calculation is demonstrated below. The method used is based on the work of Stephen Pheasant in *Bodyspace: Anthropometry, Ergonomics and the Design of Work* (Pheasant, 1996).

Suppose one would like to calculate the 99th percentile of stature for the adult female from a certain population. It happens that two parameters regarding females' height for the example sample are known: $\mu = 64.0$ in. and $\sigma = 2.4$ in., for a sample of 70 females. From Table 4.2 1, we see that for $p = 99$, $z = 2.33$. Therefore, the 99th percentile of stature = 69.59 in. The 99th percentile estimate for the population is below 69.59 in. Alternately, one may wish to do the calculation in reverse, and determine the percentile for a particular stature. Thus, a stature of 60.0 in. is 1.66 standard deviations below the mean. That is, $z = -1.66$. This is equivalent to the 5th percentile.

4.2.6 Research Needs

RESERVED

4.3 ANTHROPOMETRY

4.3.1 Introduction

Anthropometry refers to the measurement of human body lengths and circumferences, specifically relating to clearance and fit. To select which measurements are pertinent, it is necessary to understand the task to be performed and the equipment that will be used. It is also essential to understand who will be performing the work, which ensures that the proper database has been selected.

This section provides an overview of factors that affect anthropometry, the collection of anthropometric data from subjects, and proper application of the data.

4.3.2 Anthropometry Data

Anthropometry data drives the guidelines for the design of a system:

- Selection of the user population determines which database defines the anthropometry data to be used by hardware designers. The user population defines those who will be using the system and have to be accommodated.
- Once the population is defined, system developers must decide on the range of personnel in that population who will be operating and maintaining the system. Section 4.2.5.1 lists considerations for making this decision.

The results of this analysis will be a range of persons (from smallest to largest) that the system must accommodate.

Figure 4.3-1 shows a small sample of measurements that are typically found in anthropometric databases. Depending on the database consulted, the measurements included may range from simply stature and weight, to lists of thousands of measurements, including multiple postures and detailed facial measurements.

For the NASA Constellation systems development program, the NASA astronaut population was extrapolated to the year 2015. Tables were developed detailing the range from the minimum-sized person (1st-percentile female in this case) to the maximum-sized person (99th-percentile male in this case) in the population. Anthropometric data for this program can be found in Appendix B.

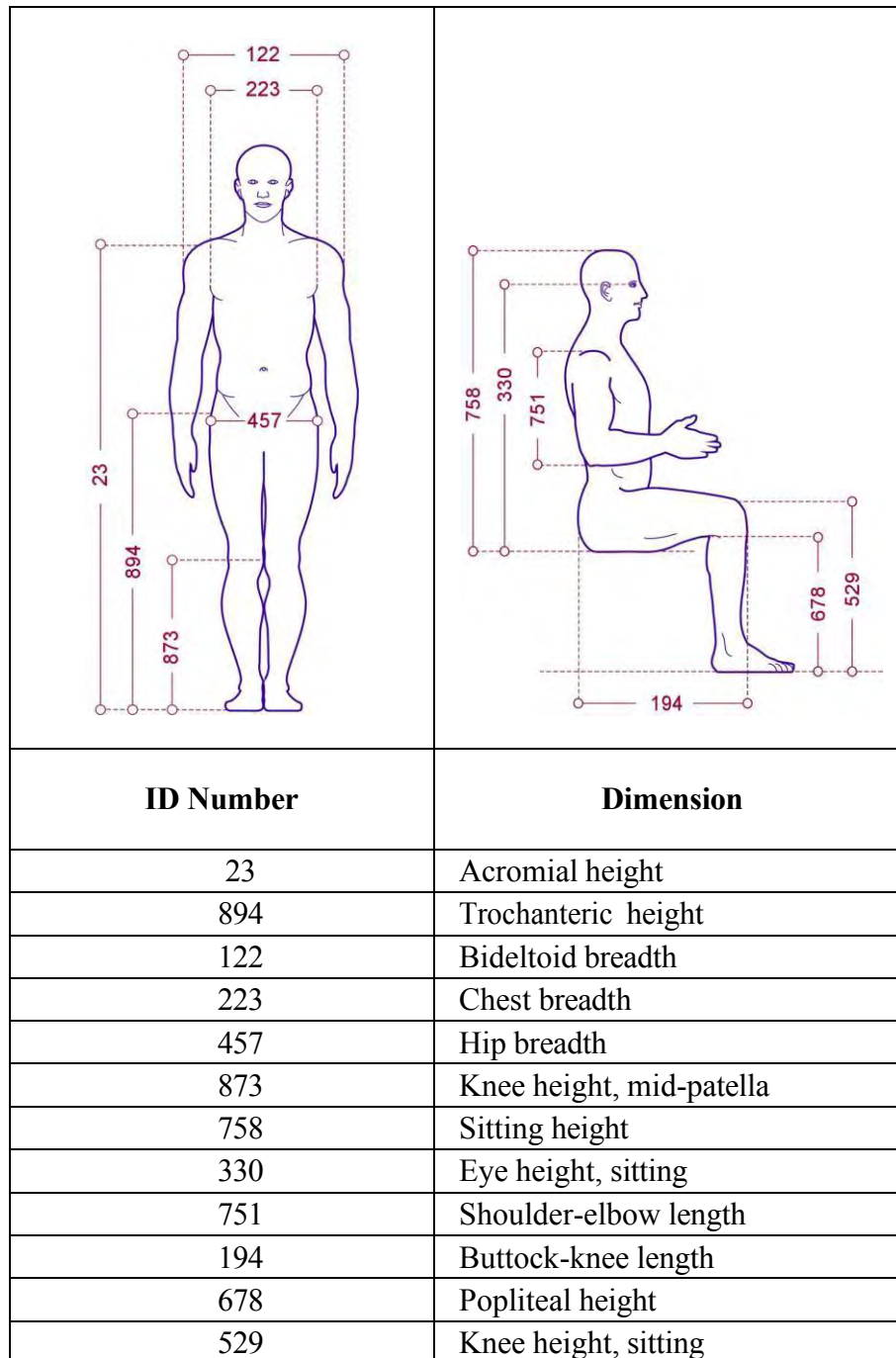


Figure 4.3-1 Sample of Commonly Provided Anthropometric Dimensions

4.3.3 Application of Anthropometry to Designs

Use of anthropometric data as design criteria should always consider (a) the nature, frequency, safety, criticality, and difficulty of the tasks to be performed by the operator or user of the equipment; (b) the position of the body during performance of these tasks; (c) the mobility and flexibility requirements imposed by these tasks; and (d) the increments in the design-critical dimensions imposed by the need to compensate for obstacles and projections. Where design

limits based on safety and health considerations are more conservative than performance criteria, they must be given preference.

4.3.3.1 Process for Accommodating Anthropometry in a Design

Two basic aspects of fitting a design to humans are clearance and reach. Evaluating clearance considerations usually addresses accommodation of larger people, whereas reach considerations accommodate smaller people. The following step-by-step processes can be used to determine the dimensions that will accommodate all of a target population.

4.3.3.1.1 Clearance

Sufficient room is necessary for all crewmembers (suited and unsuited) to fit through passageways and for unsuited crewmembers to safely and comfortably perform tasks in a workstation or activity center. It is important to note that the critical dimensions for body clearance in 0g will often differ from critical dimensions in a 1g environment. People do things differently in 0g, which may affect clearance. The following steps will be helpful to ensure that a design meets clearance requirements:

1. Identify the critical physical clearance dimension (using mock-ups, if necessary).
2. Define possible human body movements and positions relative to the critical dimension (consider the task being performed, including rescue operations or possible errors in an emergency situation, such as improper orientation for passage through a hatch).
3. Select the worst-case body position(s) that would cause clearance to be an issue.
4. Determine the body dimensions that are associated with the worst cases. Make sure to give due consideration to the involvement of other body dimensions in the worst-case body position(s).
5. Use the appropriate database to determine the value of the worst-case dimension(s) for the largest expected person. Also determine the full range (smallest person to largest person) that will define the position of the human.
6. Define the worst (bulkiest and largest) possible clothing and equipment worn or carried by the human and add this dimension to the worst-case body dimension. The results will define the design dimensions required to meet the clearance requirements.

4.3.3.1.2 Reach or Access

Controls, displays, and equipment should be positioned so that they can be accessed by all crewmembers. The following steps will help ensure that a design meets reach or access requirements:

1. Identify the critical physical access dimension (using mock-ups, if necessary).
2. Determine possible human body movements and positions relative to the critical dimension (consider the task being performed).
3. Determine the worst-case body posture(s) or dimension(s) that will cause a reach or access problem. Consider the effects of other body dimensions or body positions. For example, a person with a long torso may have to lower their seat to properly position their eyes. This must be considered when designing for an operator to reach an overhead control.

4. Determine relevant factors such as clothing, pressurization, gravity (such as spinal elongation in 0g), and any other environmental factors before using the data charts for the relevant data.
5. Use the appropriate database to determine the value of the body dimensions for the smallest expected person. Also determine the full range (smallest person to largest person), as well as other critical body dimensions that will define the worst-case scenario (i.e., body position of the human). The results will define the design dimensions required to meet reach or access requirements.

4.3.3.2 Things to Remember When Applying Anthropometric Data

Some basic considerations for the use of anthropometric data and its limitations follow:

- **Meaning of Percentile** – Use of percentiles is one way of ranking a specific physical attribute's value in a large population. Percentiles can also be used to inform us about value(s) that correspond to a specific measurement. For example, if a design accommodates a range of physical attribute values from the 1st to 99th percentiles of a population, then this design is said to accommodate that physical attribute for 98% of the user population. (It should be noted that males and females are considered to be separate populations. If a design accommodates all females with a dimension larger than 1st percentile and all males with a dimension smaller than 99th percentile, 99% of the combined user population will be accommodated.) Similarly, if a person is said to be in the 99th percentile in height, no more than 1% of the population is taller than this person, and “95th-percentile male stature” implies that the person's stature is taller than 95% of males in that specific population. It is important to note that percentile values depend on the population in which the dimension is compared; thus, a clear definition of the population is essential.
- **Missing Data** – Anthropometric databases do not contain percentile information on all possible critical anthropometric dimensions suitable for every design situation. For example, one of the critical design concerns for the hard upper torso of the pressurized extravehicular activity (EVA) suit is determining where the scye (armhole) openings fall on an individual crewmember's shoulders. The military database on which NASA's designs are based does not include a reference for this measurement. Special studies or estimations may have to be performed (depending on the criticality of the interface) when this occurs. Estimations should allow for the worst-case combination of size and interfacing hardware.
- **Size Combinations** – Where two or more individuals are located near each other (such as in a cockpit), be sure to consider all combinations of sizes (e.g., a large person and a small person reaching a common control, two large people positioned shoulder to shoulder, two small people passing equipment through a hatch). However, the maximum/minimum combination is not always the most cost-effective solution. For example, under the Constellation program, the accommodation of a full crew complement (crew of six for ISS, four for lunar) whose anthropometry are all maximum values (e.g. six crewmembers who all have 99th-percentile seated height and shoulder breadth) was far too cost prohibitive. As the requirements stated, the Orion vehicle must be able to accommodate individuals at both extremes of the anthropometric size range. However, trades were addressed on a case-by-case basis with NASA for cases in which the accommodation of a full crew complement of maximum dimensions drives excessive

cost or mass. For the case of crewmember seated height for Orion, NASA determined that it was acceptable for the vehicle to accommodate a 91st-percentile seated height male in the seat above/below a 99th-percentile seated height male, or a 95th-percentile seated height male in the seat above/below another 95th-percentile seated height male. Thus, the individual seats can still accommodate the full range of crew, but NASA must be selective about the crew complement that is flying to ensure proper overall accommodation. Also, care was taken to ensure that the crew complement selection would not be unduly impacted by the limitations. For example, if only a 30th-percentile male can fit underneath a 99th-percentile male, a larger majority of crew combinations would fail, resulting in unacceptable limitations on crew that could fly together. A balance must be struck between accommodation of crew within the design constraints and the ability of different crew combinations to fly.

- Variation of Sizes Within an Individual – Different human physical attributes from the same individual seldom have the same percentile ranking. For example, a 5th-percentile female in stature may have a 20th- or 40th-percentile arm length. Though there is some correlation among various physical attributes, the correlation is not strong across all measurements. Table 4.3-1 shows examples of correlations among dimensions based on the database of existing astronauts in 2004. It is inappropriate to refer to a “1st-percentile person” or “99th-percentile person,” because the percentile classification will not apply to all dimensions. It should also be noted that the worst-case scenario often depends on a combination of body dimensions. For example, a person with short arms but a long buttock-to-knee length may hit their knees on the dashboard of their car when they adjust their seat close enough to reach the steering wheel.

Table 4.3-1 Lack of Correlation Between Common Measurements

	Stature	Elbow Height	Knuckle Height	Fingertip Height	Waist Height	Hip Height	Knee Height	Ankle Height	Buttock to Knee	Foot Length	Arm Length
Stature	1.00	0.94	0.84	0.80	0.89	0.82	0.85	0.42	0.79	0.77	0.05
Elbow Height	0.94	1.00	0.90	0.87	0.86	0.79	0.82	0.42	0.74	0.70	0.01
Knuckle Height	0.84	0.90	1.00	0.94	0.74	0.68	0.69	0.39	0.64	0.55	0.02
Fingertip Height	0.80	0.87	0.94	1.00	0.71	0.66	0.65	0.38	0.59	0.47	0.01
Waist Height	0.89	0.86	0.74	0.71	1.00	0.85	0.86	0.41	0.78	0.69	0.08
Hip Height	0.82	0.79	0.68	0.66	0.85	1.00	0.81	0.38	0.73	0.61	0.09
Knee Height	0.85	0.82	0.69	0.65	0.86	0.81	1.00	0.44	0.75	0.67	0.07
Ankle Height	0.42	0.42	0.39	0.38	0.41	0.38	0.44	1.00	0.33	0.30	0.07
Buttock to Knee	0.79	0.74	0.64	0.59	0.78	0.73	0.75	0.33	1.00	0.65	0.03

	Stature	Elbow Height	Knuckle Height	Fingertip Height	Waist Height	Hip Height	Knee Height	Ankle Height	Buttock to Knee	Foot Length	Arm Length
Foot Length	0.77	0.70	0.55	0.47	0.69	0.61	0.67	0.30	0.65	1.00	0.04
Arm Length	0.05	0.01	-0.02	0.01	0.08	0.09	0.07	0.07	0.03	0.04	1.00

Source: Astronaut Candidate database, internal analysis, 2004.

- Lack of Correlation Between Stature and Reach or Strength – There is no strong, consistent correlation between anthropometric dimensions and strength or reach. For example, a person who is 5th percentile in stature does not necessarily have 5th-percentile reach or joint movement. Similarly, a person who is 95th percentile in height does not necessarily have 95th-percentile arm or leg strength.
- Cannot Add or Subtract Percentiles – Percentile data does not obey the laws of addition and subtraction. If the anthropometric tables list only the percentiles of forearm and upper arm lengths, for example, it is not possible to calculate the percentile of the entire arm length. One cannot add a 5th-percentile lower-arm length to the 5th-percentile upper-arm length and get the length of a 5th-percentile arm. The correct and best method is to use full arm-length data (measurement across upper and forearm lengths).
- Small-Sample Errors – Estimates of anthropometric percentiles are generated from the mean and standard deviation using large samples ($n > 100$) that are normally distributed. When using estimates, failure of either condition (small samples or non-normal data distribution) will lead to imprecise calculation of percentiles.

4.3.3.3 Factors That Affect Anthropometry

Multiple factors affect body size, including age, gender, clothing, pressurization, postures, and gravity levels. The application of anthropometry data is also affected by the environment in which a user will operate, such as ground operations versus intravehicular activity (IVA) or EVA operations.

Table 4.3-2 indicates values in different operating environments for factors affecting anthropometry. These factors are discussed in more detail below.

Table 4.3-2 Operating-Environment Values of Factors Affecting Anthropometric Dimensions

Operating Environment	Factors Affecting Anthropometric Dimensions		
	Clothing	Posture	Pressurization
Ground operations	Flight suit	Standing, sitting	None and Yes
EVA suit design	Minimal clothing	Standing, sitting	NA
Hypergravity (launch, entry)	Flight suit	Recumbent	None
Emergency during launch or entry	Flight suit	Recumbent, upright	Yes
Hypergravity (launch, entry)	Flight suit	Upright	None
Emergency during flight	Flight suit	Recumbent, upright, neutral body	Yes
IVA 0g	Minimal clothing	Neutral body	None
EVA 0g or partial-gravity	Spacesuit	Neutral body	Yes

4.3.3.3.1 Age Effects

The age of a person often affects anthropometry in individuals through changes in stature, weight, and mass distribution. Increases in stature and weight occur until maturity is reached, and then decreases in stature occur in elderly adults. Fluctuations in weight and mass distribution occur as well, with age playing an important role in these changes.

4.3.3.3.2 Gender Effects

The body size and strength of males and females follow a bivariate normal distribution and thus cannot be represented as a single population curve. However, some general observations may be made. Female measurements are typically smaller than male measurements, and female weight is typically less than male weight. The major exception to this generalization is hip breadth. The average female hip breadth, both sitting and standing, exceeds the average male hip breadth (Gordon et al., 1988).

These generalizations should not be used for design purposes where the safety and comfort of each individual is the prime concern. Because the distribution of data is separate, it is necessary to derive male and female data separately and not use any generalized relationships to represent a population of both males and females. In other words, any given male is not necessarily larger than any given female, because the two normal curves do overlap.

4.3.3.3.3 Clothing Effects

Safety concerns may require crewmembers to wear a flight suit that can be pressurized. The previous NASA design of such equipment consists of an undergarment to maintain and control temperature, a single-piece coverall suit, an oxygen mask or a helmet with a visor, and a parachute backpack.

The effects of clothing can be very important, especially for differences between shirtsleeve and suited operations. Clothing will affect size, sometimes very significantly. Different suits will affect anthropometry differently. For instance, a lighter launch/re-entry suit might be much less bulky than a hard-upper-torso planetary suit. In addition to affecting size, clothing can affect the postures that subjects select, which in turn has an impact on hardware design.

Considerations that must be included in design are the suit's impact on dimensions such as sitting height and thigh clearance, for unpressurized and pressurized conditions. This information is not available in standard anthropometric databases, so it is often necessary to derive values for the effects of clothing on anthropometry.

The suit designers have the responsibility to convey the suit's effects on the anthropometry.

4.3.3.3.4 Pressurization Effects

Pressure level is one clothing effect to consider. The dimensions of a person in a pressurized suit differ from those of someone in an unpressurized suit, and both of these differ from dimensions of a minimally clothed crewmember.

Pressurization increases the volume occupied by a crewmember by injecting breathing air inside the suit. This results in a ballooning effect of the suit, which affects the dimensions of the crewmember. Historically, few data have been available to document the effects of pressurization.

Because it may be unrealistic to obtain pressurized anthropometry data for an entire database, it is necessary to develop conversion factors to apply to more readily available anthropometric data for minimally clothed crewmembers. Data regarding pressurization effects can be obtained by testing male and female subjects who can comfortably fit into the extreme sizes of a pressure suit. (Suited measurements need to be determined with suits similar to the types of suits to be used.) Ratios between suited and unsuited sizes can then be obtained for key anthropometric dimensions. Anthropometric data for minimally clothed crewmembers can be multiplied by these ratios to provide an estimate of that subject's suited anthropometry. Even with test data, the final design must make allowances for variances in individual suit adjustments, tie-downs, restraints, and so on.

Table 4.3-3 provides an example of multipliers applied to data from unsuited crewmembers to estimate the anthropometry of suited crewmembers. These multipliers were derived from anthropometric data collected from subjects wearing an Advanced Crew Escape Suit (ACES).

Multipliers may differ for future programs, depending on the user population and the spacesuit architecture.

The suit designers have the responsibility to convey the suit’s effects on the anthropometry.

Table 4.3-3 Spacesuit (Unpressurized and Pressurized) Effects on Anthropometry

Dimension	Man		Female	
	Unpressurized	Pressurized	Unpressurized	Pressurized
Sitting Height	1.11	1.09	1.08	1.11
Eye Height - Sitting	0.99	0.95	0.92	0.85
Knee Height - Sitting	1.04	1.10	1.04	1.13
Popliteal Height	1.02	0.98	0.96	0.97
Bideltoid Breadth	1.18	1.26	1.40	1.54
Buttock-Knee Length	1.06	1.18	1.15	1.27

4.3.3.3.5 Postural Effects

Traditional anthropometric databases provide only standardized body dimensions. However, changes in posture may greatly affect body dimensions. Standard postures for anthropometry measurements are not always appropriate for application to human spaceflight.

At least two distinct postural effects must be considered during space operations: seated postural effects during launch and entry, and 0g effects during on-orbit stay. Though additional postural effects may be present due to partial gravity, this has not yet been quantified and therefore is not addressed.

During launch and entry, crewmembers are seated in a recumbent position while wearing a flight suit. Wearing a flight suit and being restrained to a seat may affect the anthropometry significantly, and recumbent seated anthropometry can differ from standard upright seated anthropometry.

The effects of 0g on posture are discussed in section 4.3.3.3.6 below.

4.3.3.3.6 0g Effects

The effects of 0g on human body size are summarized below and in Table 4.3-4. Some of these effects are independent of postural changes. The primary effects of 0g on human anthropometry are as follows:

- Standing Height Increase – Stature increases approximately 3%. This is the result of spinal elongation and the straightening of the spinal curvature (Brown, 1975; Brown, 1977; Thornton, Hoffler, & Rummel, 1977; Thornton & Moore, 1987; Webb Associates, 1978). For all standing measurements that include the length of the spine, 3% of stature must be added to allow for spinal elongation due to microgravity exposure. In addition,

clothing effects and suited anthropometry must be accounted for when determining the overall measurement growth for a crewmember wearing a suit in 0g.

- Seated Height Increase – Sitting height increases by approximately 6% of seated height. This is the result of spinal elongation, straightening of the spinal curvature, and postural effects. For all seated measurements that include the length of the spine, 6% of seated height must be added to allow for spinal elongation due to microgravity exposure (Young & Rajulu, 2011). In addition, clothing effects and suited anthropometry must also be accounted for when determining the overall measurement growth for a crewmember wearing a suit in 0g.
- Neutral Body Posture – The relaxed body immediately assumes a characteristic neutral body posture (Thornton et al., 1977; Webb Associates, 1978). Information about the impact of neutral body posture is given below.)
- Body Circumference Changes – Body circumference changes occur in 0g because fluid shifts toward the head (Thornton et al., 1977; Webb Associates, 1978).
- Mass Loss – The total mass of the body may decrease up to 8%. Mass loss can largely be prevented in current programs through better understanding of caloric needs (Webb Associates, 1978).

Table 4.3-4 Anthropometric Changes in 0g

Change	Cause	Physical Changes	Amount of Change	Critical Dimensions Affected
Spinal elongation	0g	Spinal decompression and straightening start in the first day or two of weightlessness and are retained throughout until re-exposure to 1g.	+ 3% of stature and + 6% of sitting height.	Upper body height measurements and sitting dimensions increase (including height, eye height, and overhead reach). Downward reaches will be difficult since there is no assistance from gravity.
Elimination of body tissue compression	Relief of pressure on body surfaces due to gravity	Seated height increases due to relief of pressure on buttock surfaces. Sitting knee height dimensions increase due to relief of pressure on heels.	Knee height dimensions increase minimally.	Sitting dimensions, such as sitting height, eye height, and knee height, increase.
Postural changes	0g	Body assumes the neutral body posture.	See Figure 4.3-1.	Ankle, knee, and hip heights increase; elbow, wrist, and shoulder are raised; elbows are abducted; head is tilted down.
Shifting of fluids	0g	Hydrostatic pressure is equalized.	0% to 6%.	Lower limb volume and circumferential measurements decrease. Upper torso circumference increases and face gets puffy.
Mass loss	Lack of countermeasures, inadequate diet, nausea	Muscle atrophy, body fluid loss, and bone loss occur.	0% to 8%.	Limb volume and circumferential measurements decrease.

In 0g, the fully erect standing posture of 1g is not comfortable. Instead, the human body naturally rests in a neutral configuration as illustrated in Figure 4.3-2 for a person constrained in foot restraints only. The illustration represents a mean, and individual variations should be expected and accommodated.

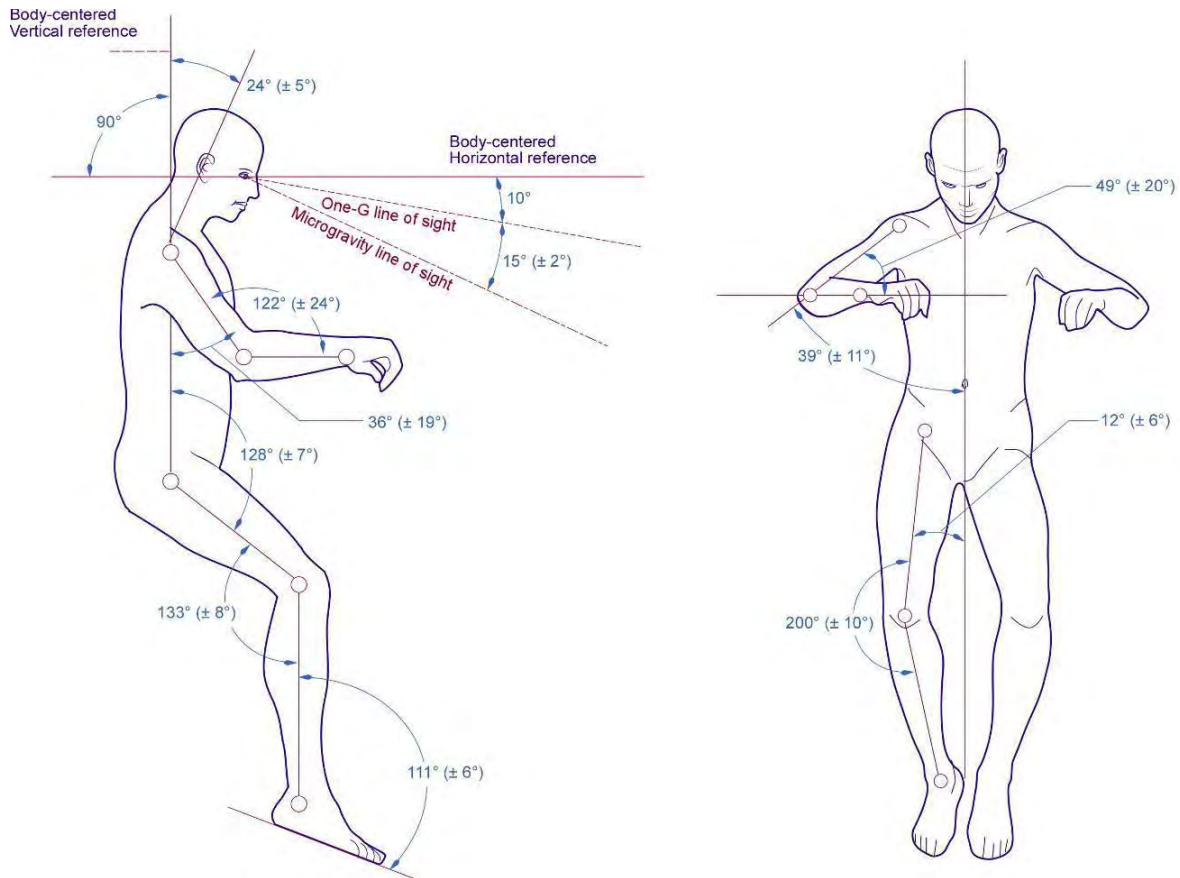


Figure 4.3-2 Neutral Body Posture in 0g

Designing to physically accommodate the human body in 0g differs from comparable accommodation for 1g. Maintaining a 1g posture in 0g will produce stress on the body as muscles are called on to supply stabilizing forces that gravity normally supplies. Stooping and bending are examples of other positions that cause fatigue in 0g. In 0g, the natural heights and angles of the neutral body posture must be accommodated. Some of the areas to be considered are the following:

- **Foot Angle** – Since the feet are tilted at approximately 111 degrees to a line through the torso, sloping rather than flat shoes or restraint surfaces should be provided (Webb Associates, 1978).
- **Foot and Leg Placement** – Foot restraints should be placed under work surfaces. The neutral body posture is not vertical because hip or knee flexion displaces the torso backward, away from the footprint. The feet and legs are positioned somewhere between a location directly under the torso (as in standing) and a point well out in front of the torso (as in sitting).
- **Height** – The height of the crewmember in 0g is between sitting and standing height. A 0g work surface should be higher than one designed for 1-g or partial-g sitting tasks.
- **Arm and Shoulder Elevation** – Elevation of the shoulder girdle and arm flexion in the neutral body posture also make elevation of the work surface desirable.

- Head Tilt – In 0g the head is angled forward and down, a position that depresses the line of sight and requires that displays be lowered.

4.3.3.3.6.1 0g Effects Lessons Learned – Neutral Body Posture and Clearance Envelope

Anthropometric dimensions can be combined with neutral body segment angles to estimate a total body envelope. Calculating maximum clearance envelopes for 1st-percentile American female dimensions and 99th-percentile American male dimensions provides an example of the use of neutral body posture combined with anthropometric data. Table 4.3-5 contains example envelopes for these specific sizes of individuals:

Table 4.3-5 Neutral Body Posture and Clearance Envelope

Dimension	1st-percentile American Female (cm)	99th-percentile American Male (cm)	Range (cm) ¹
Height ²	148.6	194.6	46.0
Height (with 3% spinal elongation) ³	153.0	200.4	47.4
Width (elbow to elbow)	38.9	66.0	27.2
Depth (back to longest fingertip)	65.0	90.9	25.9
Notes:			
1. Range is calculated by subtracting 1 st -percentile American female values from 99 th -percentile American male values.			
2. Standard (1g) height may be used for extremely short-duration missions (up to 48 hours after launch).			
3. Body height with spinal elongation must be used for 0g work envelopes in use 48 hours or more after launch.			

4.3.3.3.7 Hypergravity Effects

Currently, insufficient measurement data is available to adequately quantify the effects of hypergravity on anthropometry. Effects of hypergravity on reach are discussed in later sections.

4.3.4 Anthropometric Data Collection

In many cases, it may be necessary to measure subjects to determine missing anthropometric data. While this is not a discussion of anthropometric measurement techniques, the following points will help ensure that the data collected is useful and accurate.

Anthropometric data may be collected through traditional means such as anthropometers, tape measures, and calipers. It may also be collected through more advanced means such as three-dimensional laser scanning. Whichever method is used, several rules of thumb apply to data collection.

- Subject Clothing – The subject should be clothed appropriately for the design considerations. Traditional anthropometric measurements involve minimally clothed

subjects, for example wearing spandex shorts (with a sports bra for female subjects). However, it may be appropriate to collect additional measurements for subjects wearing mission-appropriate clothing. For example, in cockpit design, if the worst-case scenario for fit involves a large person in a pressurized suit, it would be appropriate to collect data from individuals wearing pressurized suits.

- Consistency of Measurements – Consistency is of great importance. If measurements taken are standard and intended to correspond to measurements from an existing database such as ANSUR, it is important to position subjects exactly as described and measured at the precise landmarks. If customized measurements are needed, it is important to carefully document the posture of the subject and the landmarks used in the measurement. An example of a customized measurement is the inter-wrist distance required for suit design. This measurement represents the distance between a subject's wrists when the arms are laterally extended, and it is not found in standard anthropometry handbooks.
- Measurement Accuracy – For traditional measurements, it is important to properly align measurement devices (e.g., for stature, the anthropometer should be exactly perpendicular to the floor), and measurements should be read carefully to the highest degree of accuracy made possible by the scaling on the measurement device.
- Marker Placement for Digital Scanning – For laser scanning measurements, markers should be placed on landmarks to enable measurement of a digital scan that cannot be palpated. For example, if biacromial breadth is needed during preparation for scanning, an investigator should palpate to find the correct location of the deltoids on each side and place markers appropriately.
- Advantages of Digital Scanning – Digital scanning can provide an advantage for anthropometric measurements in that the image will still exist to (re)check measurements in the future. It is not uncommon for clerical errors to lead to unrealistic dimensions in an anthropometric database, and if measurements were taken manually, the subject must return to determine the correct measurement.

4.3.5 Research Needs

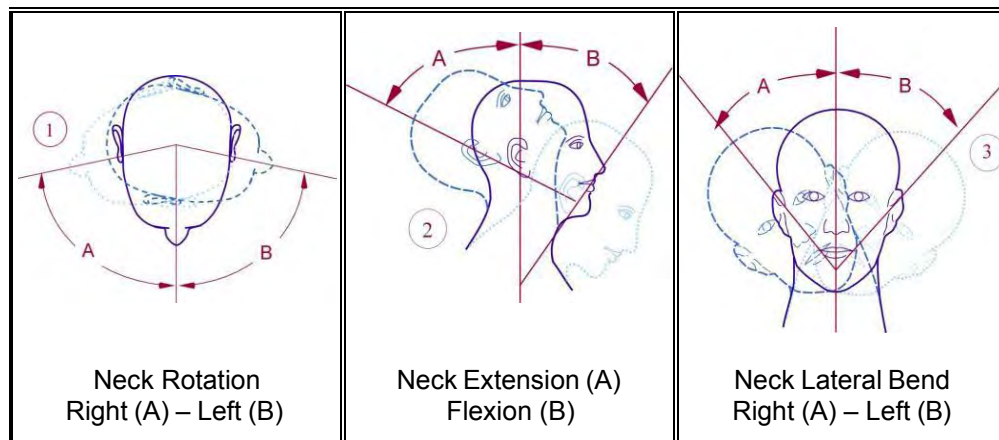
More data concerning suited anthropometry for different suit architectures is needed for unpressurized and pressurized conditions. Also, there is a need for more anthropometric data in zero- and partial-gravity (1/6 and 3/8) conditions.

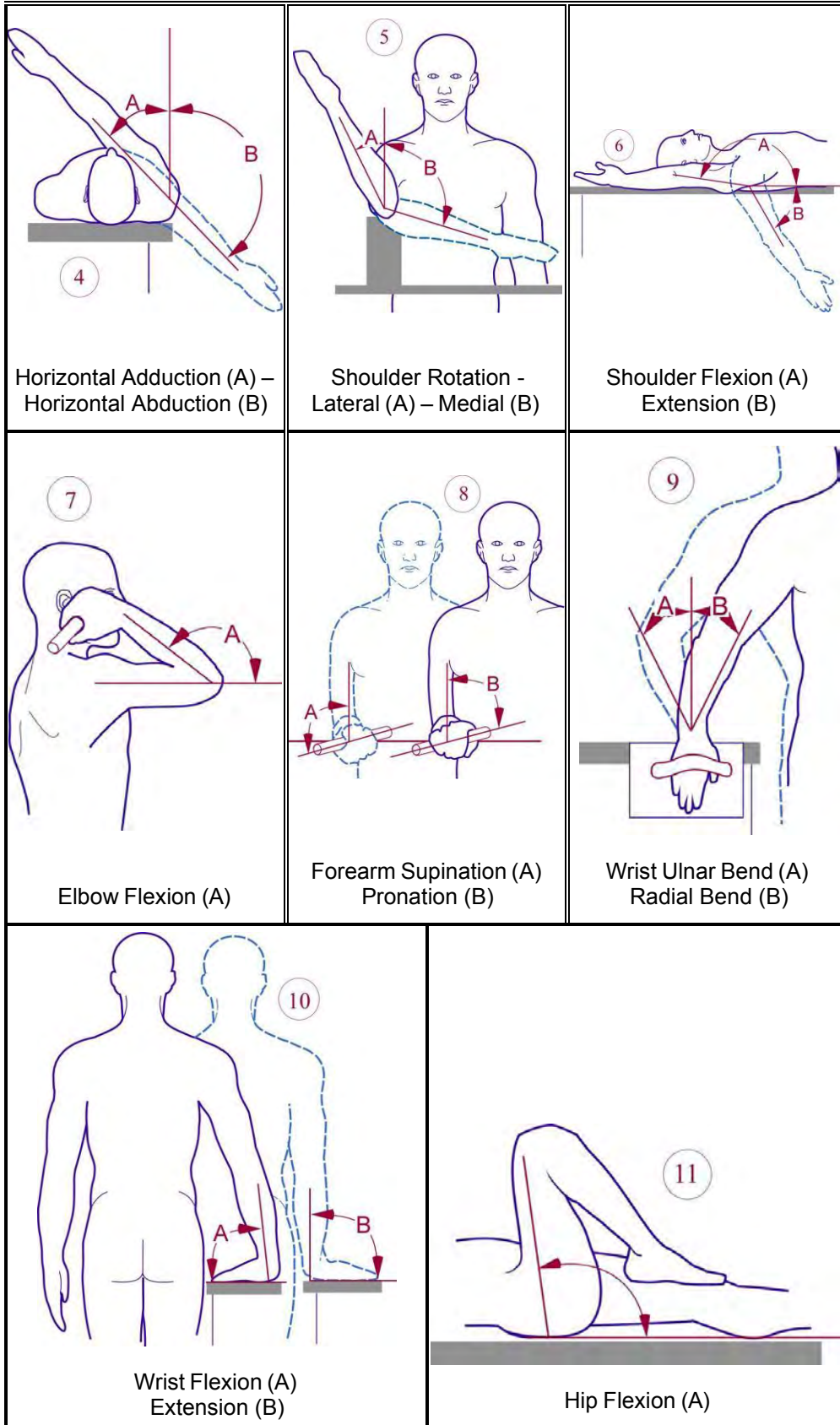
4.4 RANGE OF MOTION

4.4.1 Introduction

In this section, considerations and design requirements data regarding joint ranges of motion are provided. The information on anthropometric measurements in section 4.3 pertains to static postures and does not adequately address other human physical limitations and advantages of dynamic posture that are involved in the design of suits, garments, and other crew-dependent devices and interfaces. Humans do not maintain standard and static postures while performing a task. Furthermore, human movement varies from whole-body movement (e.g., locomotion or translation) to partial body movement (e.g., controlling a joystick with the right arm) to a specific joint or segment movement (e.g., pushing a button with a finger while holding the arm steady). Regardless of the type of movement involved, the entire body and/or various body segments are involved either by working together or by maintaining a posture while isolated or specific movements are involved.

Figure 4.4-1 illustrates upper- and lower-body movements. Descriptions and ranges of joint movement for the Constellation program males and females are in Appendix B. The range-of-motion data is applicable to shirtsleeve or unpressurized flight suit environments, while working in 1g, partial-g, and 0g conditions. At present, no data is available for 0g or hypergravity environments. Indications are that joint motion capability is not drastically affected in 0g, but hypergravity will have strong effects dependent on the vector of gravity and orientation of the body.





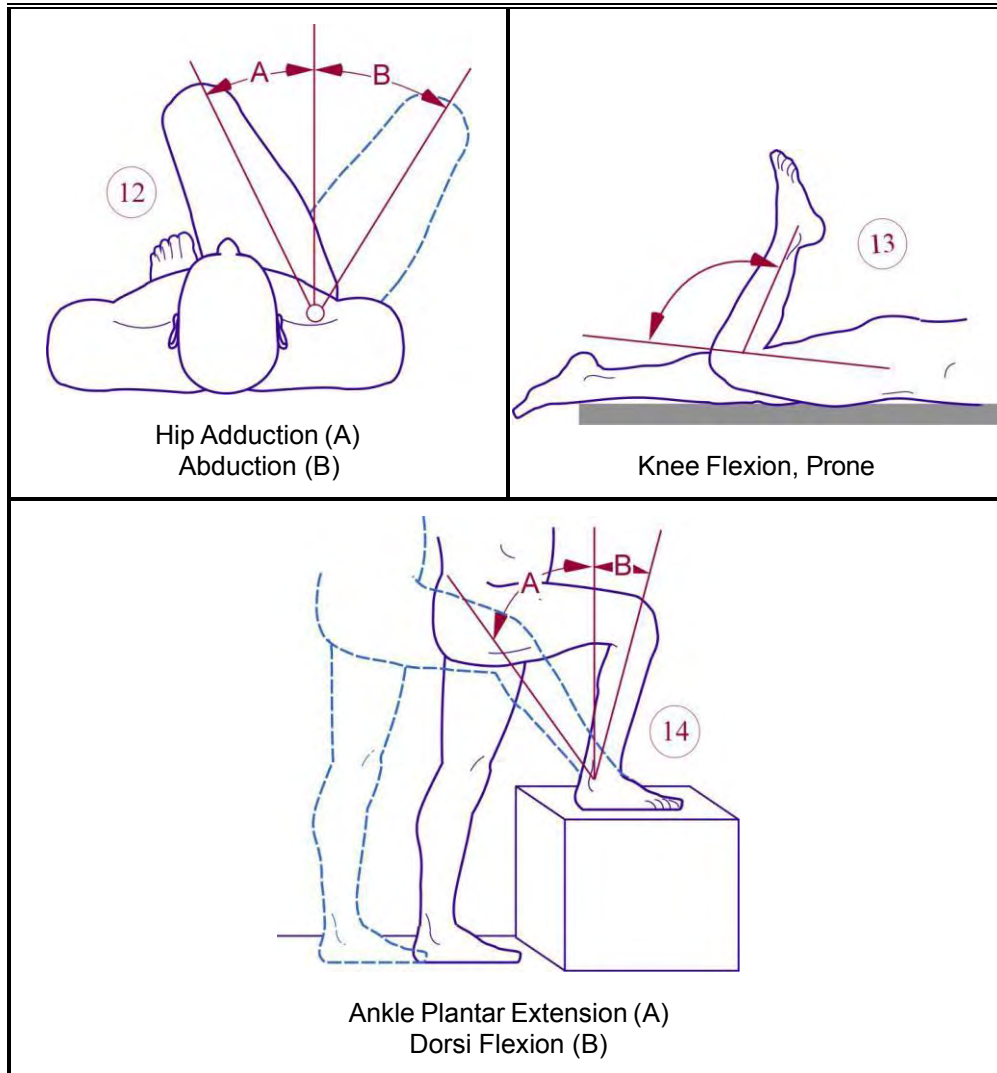


Figure 4.4-1 Illustrations of Measured Motion Range

4.4.2 Application of Range-of-Motion Data to a Design

4.4.2.1 Workstation Design and Layout

Range-of-joint-motion data will help a designer determine the proper placement and allowable movement of controls, tools, and equipment. Range-of-motion data can be combined with anthropometric dimensions and used to calculate reach and movement ranges. To sustain efficiency and accuracy of tasks that are critical or must be performed frequently or rapidly, it is important that they do not require operator movement or repositioning. This can particularly be a problem for operators who are restrained in seats or footrests.

4.4.2.2 Design of Personal Clothing and Equipment

Flight suits, spacesuits, and other worn equipment should not prohibit task performance. Some tasks that are normally performed with light IVA clothing may (under emergency conditions)

have to be performed while wearing pressure suits. Selected ranges of movement to be used for guidelines for the design of suits or other equipment that is worn by a human are shown in Tables 4.4-1 through 4.4-3. If the worn equipment can preserve the movement range, then the system is more likely to preserve crew safety and comfort. For a complete listing of Constellation program range-of-motion data, refer to Appendix B.

4.4.2.2.1 Sample Task Range of Motion to Use When Designing Personal Clothing and Equipment

Tasks usually require a number of joint movements, and each must be within the suited human capabilities. The selected list of simple tasks in Tables 4.4-1, 4.4-2, and 4.4-3 below is assumed to be typical of those required when suited operations are performed. Selected tasks were derived from the launch and entry spacesuit system manual (JSC25909, 2005). Proper use of this data will ensure the design of personal clothing and equipment that enable the user to perform many of the needed motions with ease and comfort. The data shown below is example data from the Constellation program. For the full example dataset, refer to Appendix B.

Numbers in the table cells refer to motions in the header bar, which has positive and negative defined as (+) and (-) respectively for the given motion. The following is an example of how the table is to be used. The first row entry (touch top of head) in Table 4.4-1 is as follows: The shoulder range of motion is 0° to 90° flexion (+), 20° abduction (+) to 20° adduction (-), and 10° external (+) to 45° internal (-) rotation. In addition, the elbow range of motion is 90° to 136° flexion (+) and 40° pronation (+) to 25° supination (-).

Table 4.4-1 Select Minimum Joint Range of Motion to Perform Functional Tasks with the Upper Body

Action	Example Task	Shoulder Flex(+) to Ext(-) (°)	Shoulder Ab(+) to Adduction(-) (°)	Shoulder Lateral(+) to Medial(-) Rotation(°)	Elbow Flex(+) (°)	Forearm Pronation(+) to Supination(-) (°)
Touch top of head	Lift helmet visor	0 to 90	20 to -20	10 to -45	90 to 136	40 to -25
Mobility	Open door	0 to 75	45 to -40	10 to -10	24 to 55	35 to -23

Table 4.4-2 Select Minimum Joint Range of Motion to Perform Functional Tasks with the Lower Body

Action	Example Task	Hip Flex(+) to Ext(-) (°)	Hip Ab(+) to Adduction(-) (°)	Knee Flex(+) to Ext(-) (°)
Lifting	Lifting (squatting)	0 to 117	0 to 28	0 to 117
	Lifting (bending)	0 to 117	0 to 21	0 to 117
Mobility	Sitting	0 to 104	0 to 20	0 to 93
	Kneeling	0 to 75	45 to -40	10 to -10

Table 4.4-3 Select Normal Joint Range of Motion During Walking Gait

Motion	Range	Axis of Rotation	Plane of Rotation
Pelvic anterior tilt	14.5 to 17.5	Z0	Sagittal plane
Hip flexion	0 to -46	Z1	Sagittal plane
Knee flexion	10 to 70	Z2	Sagittal plane
Tibial external rotation	0 to -15	Z2	Transverse plane
Ankle plantar flexion	0 to 16	Z3	Sagittal plane
Foot internal rotation	0	X3	Coronal plane

4.4.3 Factors That Affect Range of Motion

4.4.3.1 Body Size

Some generalities can be made regarding body physique and its relationship to joint mobility. For example, one may assume that slender humans have greater joint movement than obese humans. However, as with other physical properties, variability always exists. Individuals must be considered on an individual basis.

4.4.3.2 Age Effects

Age effects are both joint- and motion-specific. Joint mobility can decrease in some individuals as they age. Therefore, designers should consider minimal reaching tasks requiring high neck, trunk, and elbow motions in crew station design.

4.4.3.3 Gender Effects

Unless the equipment in the workspace is gender-specific (i.e., used by only one gender), then the designer should consider the upper and lower limits for the combined male and female population. In general, the female population has a slightly broader range of joint movement.

4.4.3.4 Other Individual Effects

- Exercise increases mobility; however, weight-training exercises aimed to increase muscle bulk may restrict mobility.
- Awkward and constrained body postures or loads carried by a person will restrict mobility.
- Fatigue and injury or pain affects a person's ability to maintain his or her normal range of mobility.

4.4.3.5 Multi-Joint Versus Single-Joint Effects

Frequently, human motion involves interaction of two or more joints and muscles. The movement range of a single joint is often drastically reduced by the movement of an adjacent joint. In other words, joint movement ranges are not always additive. For example, an engineering layout may show (using a scaled manikin) that a foot control is reachable with a hip flexion of 50° and the knee extended (0° flexion). Both of these ranges are within the individual joint ranges; however, the hip flexion is reduced by over 30° when the knee is extended. Therefore, the control would not be reachable.

4.4.3.6 Clothing Effects

Ideally, any flight suit with or without pressurization should be able to retain much of a crewmember's joint mobility. However, experience with the current launch and entry and EVA suits has shown that some restriction is unavoidable.

4.4.3.7 Pressurization Effects

Pressurization of flight suits does impede mobility; however, no quantitative data can be representative of all types of pressurized flight suits for space exploration, current and proposed.

4.4.3.8 Postural Effects

Sitting postures (both upright and recumbent) during launch and entry will undoubtedly affect range-of-motion capabilities because significant restraint is associated with these postures. More importantly, the reach envelope characteristics will be significantly different. These are covered in section 4.5.

4.4.3.9 Gravity Effects

4.4.3.9.1 Hypergravity Effects

The inability to reach and access controls is the most significant effect of a hyper-g environment on a crewmember's performance. This is valid for crewmembers in a recumbent or an upright position. Table 4.4-4 shows achievable body movements in a multi-g environment. However, with a limited reach capability, even if the crewmembers are able to exert these body movements, they may not be able to access the controls they may need to reach and operate, particularly during an emergency operation.

Table 4.4-4 Reach Movements Possible in a Multi-g Environment

Acceleration	Possible Reach Motion
Up to 4g	Arm
Up to 5g (9g if arm is counterbalanced)	Forearm
Up to 8g	Hand
Up to 10g	Finger

No actual range-of-motion data has ever been measured in space. Posture changes noticeably during an exposure to 0g, and these changes may affect the overall range of motion. For example, raised shoulders, a 0g effect, could both increase and decrease the capabilities of shoulder motion. However, for the most part, the range of motion may be very similar to that found on Earth. Thus, while working in shirtsleeve environments, crewmembers can safely use ranges of motion for 1g conditions under 0g conditions as well.

As far as the clothing and pressure suit effects on range of motion in 0g are concerned, it is safe to assume that the restrictions caused by these two factors in 1g conditions may also exist in 0g.

4.4.3.10 Restraint Effects

Restraint systems (e.g., torso, handholds, waist, and foot) hinder mobility during spaceflight. These systems should be used for stabilization and to help crewmembers exert a thrust or push. The following restraints are commonly used during spaceflight. Their description and limitations are provided to assist with design.

- Handhold Restraint – With the handhold restraint, the individual is stabilized by holding onto a handgrip with one hand and performing the reach or task with the other. This restraint affords a fairly wide range of functional reaches, but body control is difficult and body stability is poor.
- Waist Restraint – A waist restraint (for example, a clamp or belt around the waist) affords good body control and stabilization, but seriously limits the range of motion and reach distances attainable.
- Foot Restraint – A third basic system restrains the individual by the feet. In Skylab observations and neutral buoyancy tests, the foot restraints were judged to be excellent in reach performance, stability, and control. The foot restraint provides a large reach envelope to the front, back, and sides of the crewmember. Appreciable forces often cannot be exerted because muscles of the ankle rotators are weak. Foot restraints should be augmented with waist or other types of restraints where appropriate.

4.4.4 Collection of Range-of-Motion Data

Collection of range-of-motion data is dictated by the needs of the assessment. Several methods of measurement are available, each with associated limitations.

- A goniometer is a device with two straight edges that can rotate relative to a protractor, against which the angle between them is measured. The goniometer must be aligned with physiological landmarks on the subject, and the subjective nature of this alignment can cause variation in measuring technique between experimenters or different tests by the same experimenter.
- Photographs are another method of collecting range of motion data. Through this technique, data is extracted directly from photographs taken during the experiment. The subjective nature of data extraction can cause variation in measurements between extractors or tests.
- An inclinometer is a device that measures deviation from the vertical and can be used to measure trunk mobility. The limitation is that accuracy can be affected by initial misalignment or slipping where it is affixed to the subject.

- Motion capture is a more objective tool than goniometry or photography; however, the drawback is that the position of the markers used to track motion can shift or they can become occluded.
- In radiographic examination, range of motion is measured by taking a series of radiographs of the body and using visual inspection or a computer model to determine the relative rotation of body segments. The shortcomings of this technique are that it requires exposing subjects to large quantities of radiation and may not accurately measure rotations that are not in a single plane.
- Several specialized devices have also been designed to measure range of motion. The Lumbar Dynamometer, used to measure mobility of the back, is one example.

4.4.5 Research Needs

RESERVED

4.5 REACH ENVELOPE

4.5.1 Introduction

Human physical reach considerations and references for design requirements data are provided in this section. Reach envelopes can be defined for hand or foot controls.

It is necessary for designers to realize the impact of these reach restrictions when designing crew interfaces, particularly for flight control during hypergravity conditions in spacecraft cockpits.

4.5.2 Reach Envelope Data

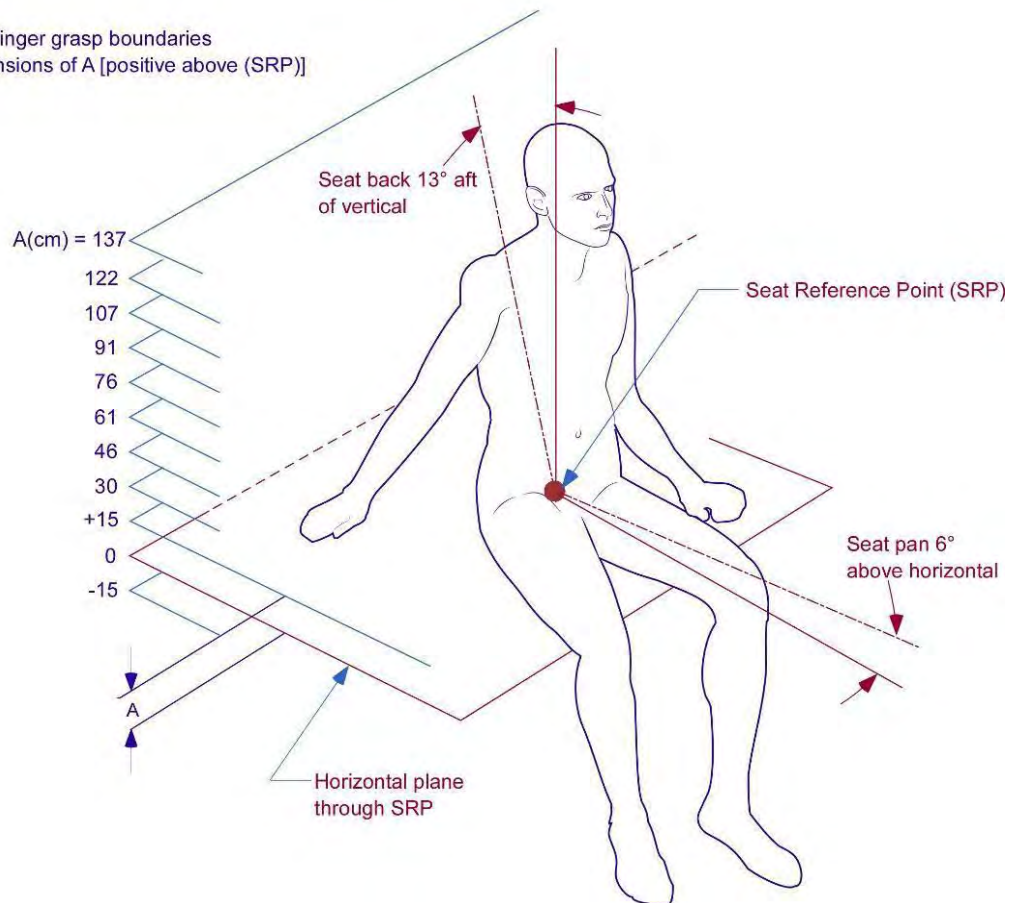
Reach envelope data is available for lightly clothed persons of varying sizes. Such information can be found in Kennedy, 1977; Pheasant, 1996; Sanders & McCormick, 1993; and Webb Associates, 1978.

An example of reach envelope is shown in Figures 4.5-1 and 4.5-2 below. For the full example dataset from Kennedy (1977), refer to Appendix B.

This reach envelope represents the limits in the horizontal plane that may be reached by seated crewmembers wearing specific restraints. (It is important to note that functional reach envelopes must be considered in the context of the activity to be performed.)

Horizontal Plane

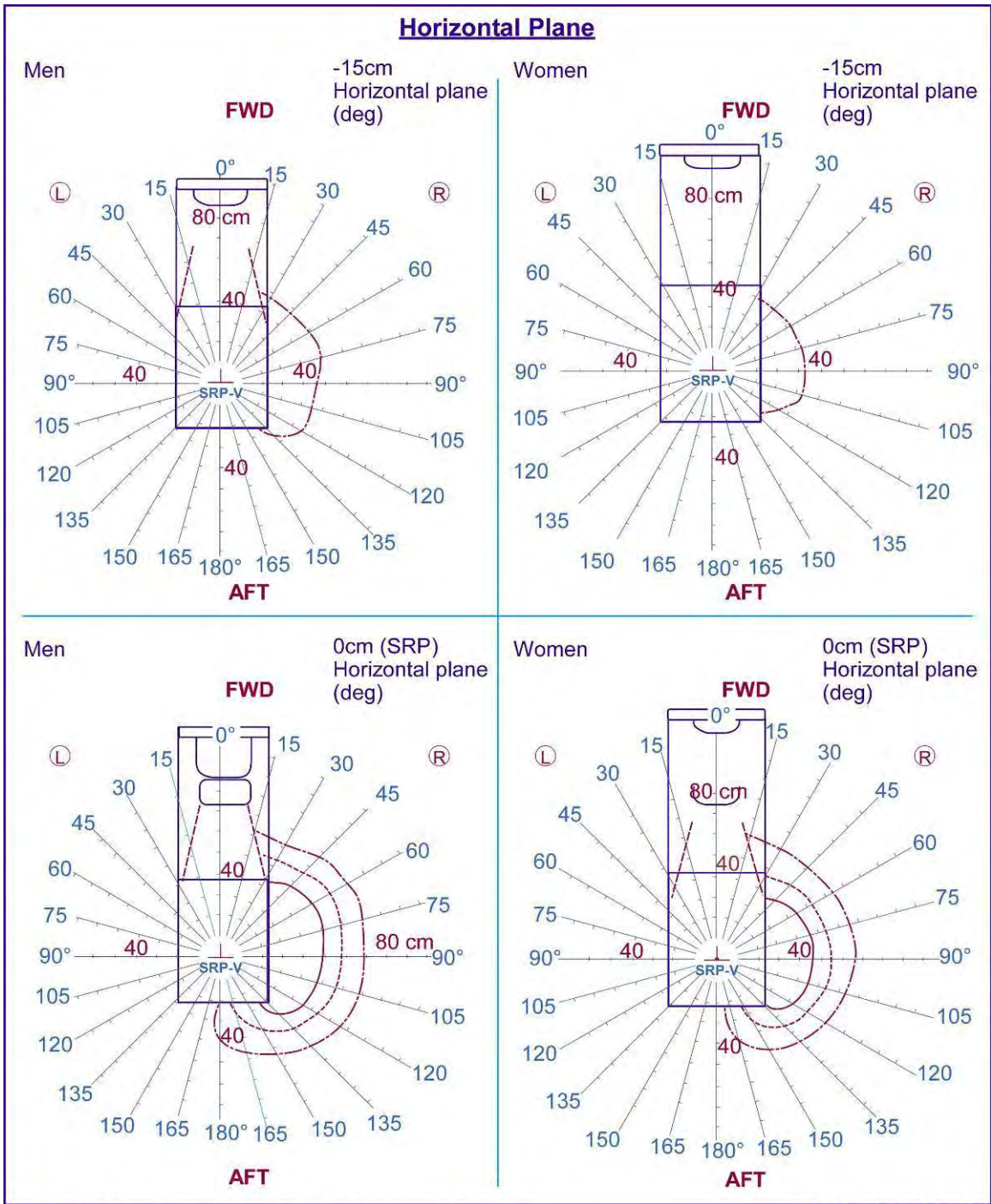
Thumb and forefinger grasp boundaries
for varying dimensions of A [positive above (SRP)]



Gravity conditions - the boundaries apply to 1g conditions only; 0g will cause the spine to lengthen, and adjustments should be made based on a new shoulder pivot location.

Subjects - the subjects used in this study are representative of the 1967 Air Force population estimated defined in NASA RP 1024, Chapter III.

Figure 4.5-1 Side Reach Horizontal Planes



— 5th percentile outer boundary and inner boundary (inner curve)
 - - - 50th percentile outer boundary
 - · - 95th percentile outer boundary

NASA-STD-3000 288b

Figure 4.5-2 Example of Reach Envelope Data in the Horizontal Plane

4.5.3 Application of Reach Envelope Data

4.5.3.1 Establishing Boundaries

In determining reach envelopes, designers need to define two boundaries:

- Maximum functional reach from the body
- Area close to the body that cannot be reached because of physical restrictions such as a lack of elbow room

The individual in the population who has the shortest functional reach should be used to define the maximum functional reach boundary, ensuring that all persons in the population will be able to achieve that reach. As a general rule, the largest individual should be used to define the boundary closest to the body. However, some exceptions to this rule may exist, such as individuals with short reach attempting to access controls on the front of a spacesuit.

4.5.3.2 Criticality of Operations

Within the overall reach envelope, some locations are visible and simple to reach, and require minimal stretching; these areas are within the optimal reach envelope. Safety-critical or frequently used controls and equipment should be located within the optimal reach envelope. Less frequently used or less critical items can be outside the optimal reach envelope. (Within the reach envelope, other location rules apply, such as sequence of use and location of controls adjacent to their associated displays.)

4.5.3.3 Restrictions

Reach data for space applications, like range-of-motion data, is greatly affected by the restricted postures maintained by crewmembers while they are wearing bulky flight suits and being restrained by straps in sometimes awkward postures. These factors are discussed in section 4.5.4. When placing controls and access panels, designers of human spaceflight equipment must ensure that they account for the reduction in crewmembers' reach capabilities.

4.5.4 Factors That Affect Reach Envelope

4.5.4.1 Body Size

Crew stations must accommodate the reach limits of the smallest crewmember. However, reach limits are not always defined by overall size. For instance, the worst-case condition for a constrained (e.g., seated with shoulder harness tight) person may be a combination of a long shoulder height and a short arm. These statistical variations in proportions should be accounted for in reach limit definitions.

4.5.4.2 Age and Gender Effects

- Age – Age effects are both joint- and motion-specific. Joint mobility can decrease in some individuals as they age. Because of this, designers should consider minimal reaching tasks requiring high neck, trunk, and elbow motions in crew station design.

- Gender – In general, the female population has a slightly broader range of joint movement. However, female limb lengths are typically shorter than male limb lengths. The combination of limb size and joint mobility must be taken into consideration.

4.5.4.3 Clothing and Pressurization Effects

Clothing and personal equipment worn on the body can influence functional reach measurements. The effect is most commonly a decrease in reach. This must be taken into account when designing work stations that will be used by crewmembers in flight suits.

Table 4.5-1 shows how the current ACES and D-suit reduce forward, vertical up-and-down, and side reach. The reduction varies from 3% to 12%, with the largest decrement occurring in vertical downward reach with an unpressurized ACES suit. When the suits are pressurized, the reduction in reach varies from 2% to 45%, with the largest decrement occurring in vertical downward reach with the pressurized D-suit.

If spacesuits are required during any phase of the space module operations, this will necessitate a substantial reduction in any design reach dimensions established for shirtsleeve operations. The extent of these differences would have to be determined from using the specific spacesuits and gear to be used in that mission.

Table 4.5-1 Change in Body Envelope Data When Wearing Pressurized and Unpressurized Flight Suits

	ACES Unpressurized		ACES Pressurized		D-Suit Unpressurized		D-Suit Pressurized	
	Change (cm)	Change Ratio	Change (cm)	Change Ratio	Change (cm)	Change Ratio	Change (cm)	Change Ratio
Recumbent								
Forward reach	0	1.00	-13	0.85	0	1.00	-4	0.95
Vertical reach - up	--	--	--	--	--	--	--	--
Vertical reach - down	-3	0.88	-6	0.85	-4	0.89	-7	0.83
Side reach	-4	0.95	0	1.00	-3	0.97	-2	0.98
Upright								
Forward reach	-14	0.87	-12	0.85	-4	0.95	-9	0.89
Vertical reach - up	-11	0.93	--	--	-10	0.94	-11	0.93
Vertical reach - down	-6	0.87	--	--	-3	0.91	-18	0.55
Side reach	-1	0.99	-6	0.93	-4	0.96	-6	0.93
"--" indicates data not available								

4.5.4.4 Postural Effects

The normal working posture of the body in a 0g environment differs substantially from that in a 1g environment (see Figure 4.3-1). The neutral body posture is the basic posture that should be used in establishing a 0g workspace layout.

4.5.4.5 Gravity Effects

During exposure to hypergravity, the range of motion for most joints will become restricted because of increases in effective whole body weight, limb weights, and segment weights. Most importantly, the neck mobility, leg mobility, and arm mobility will be severely restricted (i.e., all extremities are very heavy and it is difficult to perform useful work above approximately 3g).

4.5.4.6 Restraint Effects

While the absence of gravitational forces will usually facilitate rather than restrict body movement, this lack of gravity will leave crewmembers without any stabilization when they exert a thrust or push. Thus, some sort of body restraint system is necessary. Three basic types of body restraint or stabilizing device have been tested under neutral buoyancy conditions on Earth or 0g conditions in space. These are handhold, waist, and foot restraints. The following is a description of each type of restraint and its effect on reach:

- Handhold Restraint – With the handhold restraint, the individual is stabilized by holding onto a handgrip with one hand and performing the reach or task with the other. This restraint affords a fairly wide range of functional reaches, but body control is difficult and body stability is poor.
- Waist Restraint – A waist restraint (for example, a clamp or belt around the waist) affords good body control and stabilization, but seriously limits the range of motion and reach distances attainable.
- Foot Restraint – In Skylab observations and neutral buoyancy tests, the foot restraints were judged to be excellent in reach performance, stability, and control. The foot restraint provides a large reach envelope to the front, back, and sides of the crewmember. Appreciable forces often cannot be exerted because muscles of the ankle rotators are weak. Foot restraints should be augmented with waist or other types of restraint where appropriate.

4.5.5 Collection of Data

The collection of reach data is dictated by the needs of the assessment. Several methods of measurement are available, each with associated limitations.

- Photographs are one method of measuring reach data. With this technique, data is extracted directly from photographs taken during the experiment. The subjective nature of data extraction can cause potential variation in measurements between extractors or tests. Another limitation to this method is the type of lens used to take the photograph. Certain lenses can cause blurring or distortion of the image, thus producing an imprecise image from which data is being extracted.

- Motion capture tools, such as the Vicon Motion Analysis System (Vicon, Los Angeles, CA, USA), can be used to capture reach movements needed to generate work envelope data. The drawback is that the markers used to track motion can shift or become occluded.
- Video can also be used to collect reach data. With this method, video footage can be measured subjectively by extracting the data directly from the footage. A more precise analysis of the data can be achieved by using motion analysis software such as Dartfish (Dartfish, Ltd., Fribourg, Switzerland), which can take both angular and linear measurements from the images.
- Vertec is a specialized apparatus designed to collect reach data.
- Simpler methods are also available, for example having subjects place markers where they are able to reach and using a ruler or measuring tape to collect the distance.

4.5.6 Research Needs

RESERVED

4.6 BODY SURFACE AREA, VOLUME, AND MASS PROPERTIES

4.6.1 Introduction

This section covers the body skin surface area, volume, and mass properties based on body mass properties.

4.6.2 Body Surface Area

4.6.2.1 Body Surface Area Data

Table 4.6-1 presents data on estimated body skin surface area based on body mass and body stature. This data is based on the projected 2015 astronaut population.

Table 4.6-1 Estimated Body Surface Area of the Crewmember

Crewmember Body Surface Area, cm ²	
Female (5 th percentile in height with light weight)	15,300
Male (95 th percentile in height with heavy weight)	22,800
Notes: <ul style="list-style-type: none">• This data applies to 1g conditions.• Density was assumed constant at 1 g·cm⁻³.• References: Gehan & George, 1970; Gordon et al., 1988.	

4.6.2.2 Calculation Procedure

The body surface area of an American man is calculated as a function of stature and weight. DuBois and DuBois (1916) defined this procedure and Martin, Drinkwater, and Clarys (1984) validated the results. The calculation steps are as follows:

1. Determine the 5th-, 50th-, and 95th-percentile male stature and weight.
2. Substitute the stature and weight data into the equation below, where W is weight in kilograms, H is stature in centimeters, and the result is surface area in square centimeters.

$$Surface\ Area = 71.84W^{0.423}H^{0.723}$$

For additional information on calculating body surface area, refer to Appendix B.

4.6.2.3 Application of Body Surface Area Data

Body surface area data has several applications for space module design. These include

- Thermal control – Estimation of body heat production for thermal environmental control
- Estimation of radiation dosage

4.6.2.4 Factors That Affect Body Surface Area

- Gravity Environment – Body surface area estimation equations apply to 1g conditions only
- Fluid shifts and spinal elongation in 0g are not accounted for
- The body surface area data provided above is most accurate for the Caucasian or African American male and female body forms

4.6.2.5 Body Surface Area Data Collection

Recent advances in technology have produced a new method for collecting body surface area, volume, and mass properties data. This method is achieved via a three-dimensional whole-body scanner that accurately and efficiently captures the surface of the body. This data can then be used to compute both volume and mass property data for the whole body and body segments.

4.6.3 Body Volume

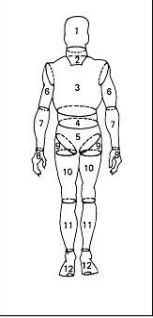
4.6.3.1 Body Volume Data

Tables 4.6-2 and 4.6-3 present select data on the volume displaced by the body as a whole and by the body segments. This data is based on the projected 2015 astronaut population. See Appendix B for a complete listing of Constellation program body volume data.

Table 4.6-2 Whole-Body Volume of Male and Female Crewmembers

Crewmember Body Volume, cm ³	
Female (5 th percentile in height with light weight)	53,685
Male (95 th percentile in height with heavy weight)	99,157
Notes: <ul style="list-style-type: none">• This data applies to 1g conditions.• Density was assumed constant at 1 g·cm⁻³.• References: Gordon et al., 1988; McConville, Clauser, Churchill, Cuzzi, & Kaleps, 1980, pp. 32-79; Young et al., 1983, pp. 18-65.	

Table 4.6-3 Select Body-Segment Volumes of Male and Female Crewmembers

	Segment	Mass, g	
		Female (5 th percentile in height and light weight)	Male (95 th percentile in height and heavy weight)
	Head	3761	4517
	Neck	615	1252
	Forearm	730	1673
	Hand	298	588

Notes:

- This data applies to 1g conditions.
- Density was assumed constant at 1 g·cm⁻³.
- References: Gordon et al., 1988; McConville et al., 1980, pp. 32-79; Young et al., 1983, pp. 18-65.

4.6.3.2 Application of Body Volume Data

Body volume data may be used for analysis of fit in suits and spacecraft. For example, a person's body volume can be compared to the internal volume of the spacesuit as a metric of fit. Estimates of volume accounted for by crewmembers may also be valuable for net habitable volume estimations. Volumes of body segments will be important in the developing role of three-dimensional anthropometric analysis.

4.6.3.3 Factors That Affect Body Volume

- Gravity Environment – Body surface area estimation equations apply to 1g conditions only. They do not account for the fluid shifts and spinal elongation in 0g.
- Population – The body volume data provided above is most accurate for the white or African American male and female body forms.

4.6.3.4 Body Volume Data Collection

Recent advances in technology have produced a new method for collecting body surface area, volume, and mass properties data. This method is achieved via a three-dimensional whole-body scanner that accurately and efficiently captures the surface of the body. The data collected from the scans can be used to calculate both volume and mass property data for the whole body and body segments.

4.6.4 Body Mass Properties

4.6.4.1 Whole-Body and Body-Segment Mass

Mass data for the whole body and body segments is provided in this section.

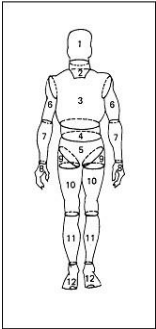
4.6.4.1.1 Data for Whole-Body and Body-Segment Mass

The select data in Table 4.6-4 and Table 4.6-5 for whole-body mass and body-segment mass is based on the projected 2015 astronaut population. All data is based on 1g measurements. For a complete listing of Constellation program whole-body mass data, refer to Appendix B.

Table 4.6-4 Whole-Body Mass of Crewmember

Crewmember Body Mass, g	
Female (5 th percentile in height with light weight)	53,685
Male (95 th percentile in height with heavy weight)	99,157
Notes: <ul style="list-style-type: none">• This data applies to 1g conditions.• Density was assumed constant at 1 g·cm⁻³.• References: Gordon et al., 1988; McConville et al., 1980, pp. 32-79; Young et al., 1983, pp. 18-65.	

Table 4.6-5 Select Body-Segment Mass Properties for Male and Female Crewmembers

	Segment	Mass, g	
		Female (5 th percentile in height and light weight)	Male (95 th percentile in height and heavy weight)
	Head	3761	4517
	Neck	615	1252
	Forearm	730	1673
	Hand	298	588
<p>Notes:</p> <ul style="list-style-type: none"> • This data applies to 1g conditions. • Density was assumed constant at 1 g·cm⁻³. • References: Gordon et al., 1988; McConville et al., 1980, pp. 32-79; Young et al., 1983, pp. 18-65. 			

4.6.4.1.2 Application of Whole-Body and Body-Segment Mass Data

Although body mass remains constant, body weight depends on gravity conditions. In 1g, body weight is calculated as indicated below:

$$\text{Weight in newtons} = \text{Mass in grams} \times 0.0098$$

and

$$\text{Weight in pounds} = \text{Mass in slugs} \times 32.2$$

4.6.4.1.3 Factors That Affect Whole-Body and Body-Segment Mass

The 0g environment causes fluids to shift upward in the body and leave the legs. This results in an upward shift of the center of mass for the whole body and a loss of mass in the leg segments. The data does not account for the fluid shifts and spinal lengthening in 0g.

4.6.4.2 Whole-Body and Body-Segment Center of Mass

This section defines the center-of-mass locations for both the whole body in defined positions and for body segments.

4.6.4.2.1 Data for Whole-Body Center of Mass

The data in Table 4.6-6 for whole-body center of mass is based on the projected 2015 astronaut population. All data is based on 1g measurements. Refer to McConville et al. (1980) and Young et al. (1983) for definitions of anatomical axes.

Table 4.6-6 Location of Whole-Body Center of Mass for Male and Female Crewmembers

Dimension	Female (5 th percentile in height and light weight)	Male (95 th percentile in height and heavy weight)
L(X)	-15.27	-6.40
L(Y)	-1.21	0.96
L(Z)	-3.81	8.16

Notes:

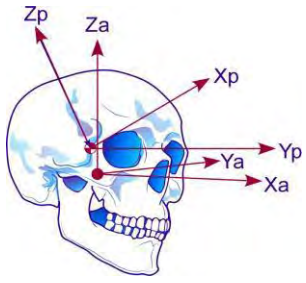
- This data applies to 1g conditions.
- Density was assumed constant at 1 g·cm⁻³.
- References: Gordon et al., 1988; McConville et al., 1980, pp. 32-79; Young et al., 1983, pp. 18-65.

4.6.4.2.2 Data for Body Segments' Center of Mass

The locations of the center of mass for select body segments in 1g are given in Table 4.6-7. The data is based on the projected 2015 astronaut population. All data is based on 1g measurements. For a complete listing of Constellation program body segment center of mass data, refer to Appendix B.

The values represented by X, Y, and Z in the Axis column relate to the coordinates for the location of the center of mass with respect to anatomical origin and are measured along the anatomical axes. The axes represented by X_a, Y_a, and Z_a are shown to represent the anatomical axes. Refer to McConville et al. (1980) and Young et al. (1983) for definitions of anatomical axes.

Table 4.6-7 Locations of Center of Mass of Select Body Segments of Female and Male Crewmembers

Segment	Axis	Female (5 th percentile in height and light weight) (cm)	Male (95 th percentile in height and heavy weight) (cm)
	X	-2.43	0.53
	Y	-0.60	0.60
	Z	2.24	4.05

4.6.4.2.3 Application of Whole-Body and Body-Segment Center-of-Mass Data

In 0g, the body mass properties define body reaction to outside forces. These forces can be

- Reactive to forces exerted by the crewmember or a hand tool
- Active forces from devices such as the Manned Maneuvering Unit

The reaction of the body to a force depends on both the mass and the relative positions of the body segments. The whole-body center-of-mass and moment-of-inertia data is provided for standing posture only. Whole-body mass properties for other positions would have to be determined by mathematically combining the mass properties of the individual segments and the appropriate postures maintained by these segments.

4.6.4.2.4 Factors That Affect Whole-Body and Body-Segment Center of Mass

The 0g environment causes fluids to shift upward in the body and leave the legs. This results in an upward shift of the center of mass for the whole body and a loss of mass in the leg segments. The data does not account for the fluid shifts and spinal lengthening in 0g.

4.6.4.3 Whole-Body and Body-Segment Moment-of-Inertia Data

This section defines the moment of inertia for both the whole body in defined positions and for body segments.

4.6.4.3.1 Data for Whole-Body Moment of Inertia

The data in Table 4.6-8 for whole-body moment of inertia is based on the projected 2015 astronaut population. All data is based on 1g measurements.

The moments of inertia for the whole body are given with respect to the principal axes of inertia, and these are denoted by X_p , Y_p , and Z_p . The relationship between the principal axes and the

anatomical axes can be found. Refer to McConville et al. (1980) and Young et al. (1983) for definitions of anatomical axes.

Table 4.6-8 Whole-Body Moment of Inertia of the Crewmember

Dimension	Female (5 th percentile in height and light weight) kg·m ²	Male (95 th percentile in height and heavy weight) kg·m ²
X _p	6.59	17.69
Y _p	6.12	16.43
Z _p	0.73	2.05
<ul style="list-style-type: none"> • This data applies to 1g conditions. • Density was assumed constant at 1 g·cm⁻³. • References: Gordon et al., 1988; McConville et al., 1980, pp. 32-79; Young et al., 1983, pp. 18-65. 		

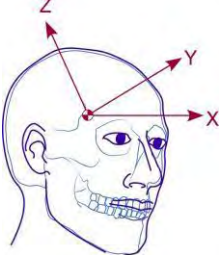
4.6.4.3.2 Data for Body-Segment Moment of Inertia

Body-segment moment-of-inertia data for the American male crewmember in 1g is in Table 4.6-9. For a complete listing of Constellation program body-segment moment-of-inertia data, refer to Appendix B.

The moments of inertia for body segments are given with respect to the principal axes of inertia, and these are denoted by X_p, Y_p, and Z_p. Refer to McConville et al. (1980) and Young et al. (1983) for definitions of anatomical axes.

The data is based on the projected 2015 astronaut population. All data is based on 1g measurements.

Table 4.6-9 Select Body-Segment Moment of Inertia of the Crewmember

Segment	Axis	5 th -percentile light Female $\times 10^{-3} \text{ (kg}\cdot\text{m}^2\text{)}$	95 th -percentile heavy Male $\times 10^{-3} \text{ (kg}\cdot\text{m}^2\text{)}$
Head 	X _p	14.81	21.56
	Y _p	17.85	24.74
	Z _p	13.58	15.97

4.6.4.3.3 Application of Whole-Body and Body-Segment Moment-of-Inertia Data

In 0g, the body mass properties define body reaction to outside forces. These forces can be

- Reactive to forces exerted by the crewmember or a hand tool
- Active forces from devices such as the Manned Maneuvering Unit

The reaction of the body to a force depends on both the mass and the relative positions of the body segments. The data for whole-body center of mass and moment of inertia is provided for standing posture only. Whole-body mass properties for other positions would have to be determined by using engineering vector analyses to combine the mass properties of the individual segments and the appropriate postures maintained by these segments.

4.6.4.3.4 Factors That Affect Whole-Body and Body-Segment Moment of Inertia

The 0g environment causes fluids to shift upward in the body and leave the legs. This results in an upward shift of the center of mass for the whole body and a loss of mass in the leg segments. The data does not account for the fluid shifts and spinal lengthening in 0g.

4.6.5 Research Needs

RESERVED

4.7 STRENGTH

4.7.1 Introduction

The term “strength” is often used to refer to a person’s ability to generate force. Because of the difficulty in measuring strength, it is difficult to formulate a clear definition of the term. One appropriate definition is “the magnitude of variable force that a [muscle group] exerts on the skeletal system at the attachment site of interest” (Kulig, Andrews, & Hay, 1984).

The content in this chapter primarily supports Volume 2 requirements in Section 4.8. Crew strength requirements (pre-, in-, and post-flight) can be found in Volume 1, Section 4.2.8.



Information related to physical workload can be found in HIDH Chapter 5.2. Information related to exercise countermeasures can be found in HIDH Chapter 7.5.

4.7.2 Strength Data Presentation

Unlike anthropometric data, strength data from different populations is not readily available. Even if it is available, sample sizes are often small. Thus it is difficult to find strength percentile data. Instead, strength data often shows maximum and minimum values based on the weakest and strongest members of the population.

Table 4.7-1 depicts a sample of strength data to illustrate typical information available. The full dataset can be found in Appendix B.

Table 4.7-1 Examples of Strength Data Tables

Type of Strength		Minimum Crew Operation Loads (N(Lbf))			Maximum Crew Operational Loads (N(Lbf))
		Critical 1 Operations	Critical 2 Operations	Other Operations	
One-Handed Pulls		One-Handed Pulls			
Seated Horizontal Pull In ¹ [Subject in a seated position pulls toward his/her body. Unilateral/isometric measurement]		111 (25)	147 (33)	276 (62)	449 (101)
Seated Vertical Pull Down ¹ [Subject in a seated position pulls downward. Unilateral/isometric measurement]		125 (28)	165 (37)	311 (70)	587 (132)

¹ Estimated strength decrement post-spaceflight. Range is 0%-26%. Average estimated is 20%. Based on max EDOMP data. Not all motions were measured on EDOMP missions.

4.7.3 Application of Strength Data

4.7.3.1 Maximum or Minimum Data

Instead of using percentile data for strength, the recommendation is to use the design limits that reflect the minimum strength exhibited by the weakest user group and the structural limits that reflect the maximum strength exhibited by the strongest user group.

Maximum Forces and Structural Integrity – System components and equipment that are intended to be operated by unsuited crewmembers should withstand the forces exerted by the strongest crewmembers without sustaining damage.

Normal Operating Forces – System components and equipment that are intended to be operated by unsuited crewmembers should require forces no greater than those exerted by the weakest crewmember.

4.7.3.2 Criticality of Operations

The criticality of operations may dictate whether factors of safety should be incorporated into strength requirements. In the example data in Appendix B, the following criticality definitions were selected:

- Criticality 1 load limits are to be used for crew safety situations and the design of items where a single failure could result in loss of life or spacecraft.
- Criticality 2 load limits are to be used for the design of items of which a single failure could result in a loss of mission.

Load limits are smaller for Criticality 1 processes, to protect the lives of the crew.

4.7.3.3 Other Factors to Consider in Application of Data

Important aspects of applying strength data to human-centered design include defining a user population, selecting an appropriate database, understanding the activity for which strength should be defined, and collecting data correctly. Endurance and fatigue must be considered in relation to strength as well, and strength is affected by many different factors. Some of these factors affect a person's strength during everyday life, and some are specific to spaceflight.

4.7.4 Factors That Affect Strength Data

4.7.4.1 User Population

As with any human-centered design consideration, the person who will be performing the activity must be considered. The database selected should reflect the likely user population in terms of age, gender, fitness, and other characteristics as closely as possible.

4.7.4.2 Activity Type

The type of activity and interactions between the human and environment will dictate whether minimum or maximum strength is of concern. The level of criticality will also determine if factors of safety are needed.

In most cases, the goal of understanding strength data is to ensure that the weakest crewmember can perform a task. For example, the torque required to open a hatch should be within the capability of the weakest member of the population.

In some cases, structural limits are in place to prevent accidental damage from crewmembers. For example, the torque required to break a piece of equipment might be required to be more than the maximum torque produced by the strongest crewmember.

The duration of the activity has a major effect on the strength a person can exert. Strength drops off significantly with the extended duration of an activity.

Strength data reflects the type of action being performed during data collection. The table below summarizes the most common approaches to strength data collection (Kroemer, Kroemer, and Kroemer, 1997).

Table 4.7-2 Common Approaches to Strength Data Collection

Isometric	Constant muscle length
Isovelocity / Isokinetic	Constant angular velocity
Isotonic	Constant muscle tension

4.7.4.3 Anthropometry

Because of the low correlation between strength and size, anthropometry should not be used to determine accommodation of strength and endurance. Though strength is related to the size of muscles, research has failed to predict an individual's strength for given activities based on anthropometry, including circumferences around major muscles (Kroemer, 1976).

4.7.4.3.1 Age Effects

Strength tends to peak around age 20 to 25, with gradual decreases over time. Leg strength tends to decrease more rapidly than arm strength (Konz, 1983). Age is not a reliable predictor of strength within a population because of large intersubject variability, but it is a factor in strength of individuals.

4.7.4.3.2 Gender Effects

The strength of the average female is generally less than the strength of the average male. Much of the published literature claims that the strength of females is 60% to 70 % that of males. This may be true when comparing the average strengths of 1000 men and 1000 females. But recent studies comparing males and females of the same height and weight show that the percentage goes up to 80% to 90%. Therefore, females have less strength mostly because of their smaller size and not because of their gender. Though it is important to consider gender when selecting a population for strength studies, gender is not an accurate predictor of strength.

4.7.4.3.3 Clothing Effects

Wearing a pressurized suit affects a person's ability to exert the maximum effort. Simply wearing the suit affects strength, and pressurizing the suit reduces strength further. A study by Gonzalez, Maida, Miles, Raiulu, and Pandya (2002) indicated that joint torque production

capabilities of subjects decreased up to 39% while they were wearing a pressurized suit, shown in Table 4.7-3.

Table 4.7-3 Effect of Wearing a Pressurized Suit on Maximum Voluntary Torque

Joint Motion	MVT (N·m)		Reduction or Increase in Percentage
	Unsuited	Suited	
Wrist extension	11	7	-36
Wrist flexion	18	11	-39
Elbow extension	43	34	-21
Elbow flexion	39	33	-15
Shoulder extension	63	67	+6
Shoulder flexion	61	42	-31
Shoulder abduction	50	34	-32
Shoulder adduction	54	41	-24
Shoulder external rotation	21	19	-10
Shoulder internal rotation	39	37	-5
Average	40	33	-18
Note: - refers to reduction, + refers to increase in torque produced			

Functional strength tests involving tasks such as pushing and pulling rather than isolated joint movements have shown that a pressurized I-suit reduces functional strength up to 50% (current NASA study, unpublished data).

4.7.4.3.4 Postural Effects

When gravity is present, the amount of force a person is capable of exerting depends on posture. The major example of this during spaceflight is recumbent seating versus upright seating. If a crewmember must overcome gravity to perform a given task, the force production capability will be greatly reduced.

4.7.4.3.5 0g Effects

The major effects of 0g on strength are related to counter-reactive forces, restraints, and deconditioning, discussed below. Though some activities, such as lifting a box, will require less strength in 0g, other activities, such as opening a hatch, will still require full strength.

4.7.4.3.6 Hypergravity Effects

In hypergravity environments, the weight of the body segments involved in a task increases in unison with gravity, and thus exerting the necessary force becomes an excessive burden. The

bulk of the effort exerted by the crewmember goes toward either bringing in or maintaining body segments in a required posture, causing simple tasks to be more difficult in hypergravity environments.

4.7.4.3.7 Counter-Reactive Forces

The lack of gravity leads to the absence of counter-reactive forces that allow people to effectively perform physical work in 1g. Traction (friction force), which depends on body weight, is also absent, as are forces that result from using body weight for counterbalance. Without proper restraints, a crewmember's work capabilities will generally be reduced and the time to complete tasks increased.

4.7.4.3.8 Restraints

The common notion is that when workstation design (including fixed and loose equipment) and task procedures are optimized for the 0g environment, crewmembers' work capabilities while they are restrained can approach their capabilities for performing Earth-based tasks. However, quantitative data (Poliner, Wilmington, & Klute, 1994) has shown that even with foot restraints, the strength exhibited by shirtsleeve subjects in 0g is about 17% less than their strength in 1g.

Situations do exist in which a crewmember can achieve improved strength performance in 0g. These situations occur when the crewmember uses the greater maneuverability in 0g to achieve a more efficient body position to be able to push off solid surfaces.

4.7.4.3.9 Deconditioning Effects

Strength is reduced with longer missions because of the deconditioning of muscles. Experience in space indicates that both the strength and aerobic power of load-bearing muscles in crewmembers decreases during missions exposing them to 0g. Exercise countermeasures have been used to counter these deficits, but to date have been only partially effective.

The results of a study by Adams, Caiozzo, and Baldwin (2003) indicate that spaceflight without exercise may cause greater muscle atrophy than bed rest. It should also be noted that greater loss of leg muscle strength than arm muscle strength is expected because locomotion is performed with the upper body during spaceflight (Cowell, Stocks, Evans, Simonson, & Greenleaf, 2002). Results of spaceflight studies are also affected by countermeasure efforts taken during flights of greater than 10 days (Adams et al., 2003).

Table 4.7-4 provides percent decreases in strength for muscle groups in spaceflight and bed rest studies with and without countermeasure exercise.

Table 4.7-4 Effects of Spaceflight and Bed Rest on Strength

Muscle Group	Spaceflight w/o Exercise			Spaceflight w/ Exercise			Bed Rest (w/o Exercise)		
	# days	% decrease	Description	# days	% decrease	Description	# days	% decrease	Description
Arm Extensor ¹	28	20	Isokinetic	28	0	Isokinetic	42	10	Isometric
	--	--	--	59	0	Isokinetic	--	--	--
	--	--	--	84	10	Isokinetic	--	--	--
Arm Flexor ¹	28	20	Isokinetic	28	15	Isokinetic	42	12	Isometric
	--	--	--	59	0	Isokinetic	--	--	--
	--	--	--	84	0	Isokinetic	--	--	--
Leg Extensor ^{1,2,3}	5-13	12	Isokinetic	11	10	Isokinetic	14	15	Isokinetic
	--	--	--	59	20	Isokinetic	30	21	Isokinetic
	--	--	--	84	0	Isokinetic	42	29	Isokinetic
	--	--	--	125-145	31	Unknown	119	30	Isokinetic
	--	--	--	125-145	12	Isokinetic	--	--	--
Leg Flexor ^{1,2,3}	5-13	6	Isokinetic	28	20	Isokinetic	30	10	Isokinetic
	--	--	--	59	20	Isokinetic	--	--	--
	--	--	--	84	14	Isokinetic	--	--	--
	--	--	--	125-145	27	Unknown	--	--	--
	--	--	--	125-145	27	Isokinetic	--	--	--
Trunk Flexion ³	--	--	--	11	20	Isokinetic			
Calf Muscle ³	--	--	--	17	0	Unknown	35	25	Unknown
	--	--	--	~180	42	Isometric	120	45	Unknown

¹ Cowell et al. (2002).

² Convertino and Sandler (1995).

³ Adams et al. (2003).

4.7.4.4 Collection of Data

Results of strength studies are highly dependent on the type of strength test done, the measurement techniques, and the measurement devices chosen. In addition, the selection of a population representative of the end-user to study is critical.

The most common types of strength tests are isometric, isokinetic, and isotonic testing (Kroemer, Kroemer, & Kroemer-Elbert, 2001). Isometric testing is static, with muscle lengths remaining the same throughout the exertion; isokinetic tests involve constant velocity; and isotonic tests consist of constant force.

One major factor involved in measurement technique is the device with which strength is measured. Measurements are most often taken with a dynamometer system. A dynamometer can be something as simple as a mechanical device to record maximum force during grip, or a much more advanced machine with computing capabilities that allows testing to be conducted in a variety of conditions.

Other facets of measurement technique are the speed of contraction, number of joints involved in a movement, and orientation of the subject with respect to gravity (Kulig et al., 1984). Concentric testing involves dynamic contractions in which a subject's strength overcomes the resisting force, and eccentric testing involves dynamic contractions in which a subject is overcome by a resisting force and the muscle actually lengthens during the contraction (Kroemer, 1976).

In addition, the interaction of test conductors with subjects can heavily influence results. It is highly recommended that test conductors follow a methodology such as that outlined by Caldwell et al. (1974), which specifies the following in regard to isometric (static) testing:

- Strength is assessed during a steady exertion sustained for 4 seconds
- Effort should be increased to maximum without jerking in about 1 second, then maintained
- No instantaneous feedback is provided during testing
- No goal-setting, rewards, or competition should occur during testing
- A minimum of 1 minute of rest is provided between trials

The aspects of the Caldwell methodology concerning lack of feedback, goal-setting, and rewards should be applied to any type of strength testing to obtain more consistent results. These external factors have been demonstrated to significantly affect force generated during trials (Kroemer, et. al., 1988).

4.7.5 Research Needs

RESERVED

4.8 REFERENCES

- Adams, G.R., Caiozzo, V.J., & Baldwin, K.M. (2003). Skeletal muscle unweighting: Spaceflight and ground-based models. *Journal of Applied Physiology*, 95(6), 2185-2201.
- Brown, J. (1975). ASTP002: Skylab 4 and ASTP crew height. *NASA Life Sciences Data Archive*. Retrieved from <http://lsda.jsc.nasa.gov>.
- Brown, J. (1977). Crew height measurement. In A. Nicogossian (Ed.), *The Apollo-Soyuz Test Project Medical Report* (pp. 119-121). Washington, DC: NASA.
- Caldwell, L., Chaffin, D., Dukes-Dobos, F., Kroemer, K.H.E., Laubuch, L., Snook, S., & Wasserman, D. (1974). A proposed standard procedure for static muscle strength testing. *American Industrial Hygiene Association Journal*, 35(4), 201-206.
- Convertino, V., & Sandler, H. (1995). Exercise countermeasures for spaceflight. *Acta Astronautica*, 35(4-5), 253-270.
- Cowell, S.A., Stocks, J.M., Evans, D.G., Simonson, S.R., & Greenleaf, J.E. (2002). The exercise and environmental physiology of extravehicular activity. *Aviation, Space, and Environmental Medicine*, 73, 54-67.
- Constellation Program Human-System Integration Requirements (HSIR) (CxP 70024)*, Rev. B. (2007). Houston, TX. NASA, Johnson Space Center.
- Crew Systems Reference Manual Vol. 1 (JSC 25909) Rev. A*. Houston, TX. NASA, Johnson Space Center.
- DuBois, D., & DuBois, E.F. (1916). Clinical calorimeter: A formula to estimate the approximate surface if height and weight be known. *Archives of Internal Medicine*, 17, (Part II).
- Gehan, E.A., & George, S.L. (1970). Estimation of human body surface area from height and weight. *Cancer Chemotherapy Reports*, 54, 225-235.
- Gonzalez, J.L., Maida, J.C., Miles, E.H., Rajulu, S.L., & Pandya, A.K. (2002). Work and fatigue characteristics of unsuited and suited humans during isolated isokinetic joint motions, *Ergonomics*, 45, 484-500.
- Gordon, C., Churchill, T., Clauser, C.E., Bradtmiller, B., McConville, J.T., Tebbetts, I., Walker, R.A. (1989b). *1988 Anthropometric Survey of US Army Personnel: Methods and Summary Statistics (No. Natick-TR-89-044)*, US Army Natick Research & Design Center, Natick, MA.
- Kennedy, K. (1977). *Reach capability of men and women: A three-dimensional analysis (AMRL-TR-77-50)*. Wright-Patterson Air Force Base, OH: Aerospace Medical Research Laboratory.
- Konz, S. (1983). *Work design: Industrial ergonomic*. (2nd ed.). Columbus, OH: Grid Publishing, Inc.
- Kroemer, K.H. (1976). The assessment of human strength. Safety in Manual Materials Handling Symposium, State University of New York at Buffalo.
- Kroemer, K.H., Snook, S.H., Meadows, S.K., Deutsch S., (1988). *Ergonomic Models of Anthropometry, Human Biomechanics, and Operator-Equipment Interfaces*. Proceedings of a Workshop, Washington, D.C. National Academy Press.

- Kroemer, K.H., Kroemer, H.J., & Kroemer, K.E. (1997). *Engineering Physiology: Bases of Human Factors/Engineering* (3rd ed.). New York, NY: International Publishing Company.
- Kroemer, K.H., Kroemer, H.B., & Kroemer-Elbert, K.E. (2001). *Ergonomics: How to design for ease and efficiency* (2nd ed.). Upper Saddle River, NJ: Prentice Hall.
- Kulig, K., Andrews, J., & Hay, J. (1984). Human strength curves. *Exercise and Sport Science Reviews*, 12, 417-460.
- Martin, A.D., Drinkwater, D.T., & Clarys, J.P. (1984). Human body surface area: Validation of formulae based on a cadaver study. *Human Biology*, 56, 475-488.
- McConville, J.T., Clauser, C.E., Churchill, T.D., Kaleps, I., & Cuzzi, J. (1980). *Anthropometric relationships of body and body segment moments of inertia* (AFAMRL-TR-80-119). Wright-Patterson Air Force Base, OH: Air Force Aerospace Medical Research Laboratory.
- Man-Systems Integration Standards* (MSIS) (NASA-STD-3000), Rev B. (1995). Houston, TX: NASA Johnson Space Center.
- Ogden, C.L., Fryar, C.D., Carroll, M.D., Flegal, K.M. (2004). *NHANES (National Health and Nutrition Examination Survey): Mean body weight, height, and body mass index, United States 1960–2002*. Washington, DC: U.S. Department of Health and Human Services.
- Pheasant, S. (1996). *Bodyspace: Anthropometry, ergonomics and the design of work*. Bristol, PA: Taylor & Francis Inc.
- Poliner, J., Wilmington, R., & Klute, G. (1994). *Geometry and gravity influences on strength capability* (NASA/TP-3511). Houston, TX. NASA Johnson Space Center.
- Sanders, M., & McCormick, E. (1993). *Human factors in engineering and design* (7th ed.). New York: McGraw-Hill.
- Tillman, B. & McConville, J. (1991). Year 2015 Astronaut Population Anthropometric Calculations for NASA-STD-3000, Houston, TX. NASA, Johnson Space Center
- Thornton, W., Hoffler, G., & Rummel, J. (1977). Anthropometric changes and fluid shifts. In R. Johnston and L. Dietlein (Eds.), *Biomedical results from Skylab* (pp. 330-338). Washington, DC: NASA.
- Thornton, W., & Moore, T. (1987). Height changes in 0g. In *Results of the life sciences DSOs conducted aboard the Space Shuttle 1981-1986* (pp. 55-57). Houston, TX: NASA.
- Webb Associates (Eds.). (1978). *Anthropometric source book: Vol. I. Anthropometry for designers* (NASA 1024). Yellow Springs, OH: Anthropology Research Project, Webb Associates.
- Young, J.W., Chandler, R.F., Snow, C.C., Robinette, K.M., Zehner, G.F., & Lofberg, M.S. (1983). *Anthropometrics and mass distribution characteristics of the adult female*. (FAA-AM-83-16), Revised Edition. Oklahoma City, OK: FAA Civil Aeromedical Institute.
- Young, K., Rajulu, S. (2011) *Spinal Elongation and its Effect on Seated Height in a Microgravity Environment*. Houston, TX. NASA Johnson Space Center.

TABLE of CONTENTS

5	HUMAN PERFORMANCE CAPABILITIES.....	102
5.1	INTRODUCTION.....	102
5.2	PHYSICAL WORKLOAD.....	102
5.2.1	Introduction	102
5.2.2	Aerobic and Cardiovascular Fitness.....	103
5.2.2.1	Aerobic/Cardiovascular Fitness Adaptations to Microgravity	104
5.2.2.2	In-flight Aerobic Fitness Requirements	105
5.2.2.3	Exercise Countermeasures for Aerobic/Cardiovascular Fitness	105
5.2.3	Muscle.....	106
5.2.3.1	Muscle Adaptations to Spaceflight.....	106
5.2.3.2	Muscular Fitness Requirements	107
5.2.3.3	Exercise Countermeasures for Muscular Fitness	107
5.2.3.4	Maintenance of Muscular Fitness	108
5.2.4	Bone	109
5.2.4.1	Bone Adaptations to Spaceflight.....	109
5.2.4.2	Exercise Countermeasures for Bone	109
5.2.5	Summary	110
5.2.6	Research Needs	110
5.3	SENSORIMOTOR FUNCTION.....	110
5.3.1	Introduction	110
5.3.2	Perceptual and Motor Performance.....	111
5.3.3	Spatial Disorientation	113
5.3.3.1	Acceleration and Hypergravity Effects	114
5.3.3.2	Acceleration and Hypergravity Countermeasures.....	115
5.3.3.3	0g Effects.....	118
5.3.3.4	0g Countermeasures	119
5.3.4	Oculomotor Control and Active Vision	120
5.3.4.1	Acceleration and Hypergravity Effects.....	120
5.3.4.2	0g Effects.....	120
5.3.4.3	Vibration Effects.....	121
5.3.4.4	Oculomotor Control Countermeasures.....	122
5.3.5	Hand-Eye Coordination.....	123
5.3.5.1	Acceleration and Hypergravity Effects	123
5.3.5.2	0g Effects	124
5.3.5.3	Vibration Effects.....	124
5.3.5.4	Hand-Eye Coordination Countermeasures	125
5.3.6	Balance and Locomotion.....	125
5.3.6.1	Postflight Effects.....	125
5.3.6.2	Countermeasures for Sensorimotor Function.....	126
5.3.7	Research Needs	126
5.4	VISUAL PERCEPTION.....	127
5.4.1	Introduction	127
5.4.2	The Eye and Visual Brain.....	127
5.4.3	The Visual Stimulus	127

5.4.4	Thresholds and Sensitivity	128
5.4.5	Visual Optics	129
5.4.5.1	Refractive Errors	130
5.4.5.2	Wavefront Aberrations	130
5.4.5.3	Pupillary Reflex	130
5.4.5.4	Light Scatter	131
5.4.6	Sensitivity vs. Wavelength	131
5.4.7	Light Adaptation	133
5.4.8	Spatial Sensitivity	135
5.4.8.1	Threshold vs Size	136
5.4.8.2	Acuity	137
5.4.8.3	Spatial Contrast Sensitivity Function	137
5.4.8.4	Masking	140
5.4.8.5	Models	141
5.4.8.6	Effects of Age	141
5.4.8.7	Summary	141
5.4.9	Temporal Sensitivity	142
5.4.9.1	Definition	142
5.4.9.2	Temporal Summation	142
5.4.9.3	Temporal Contrast Sensitivity Function	143
5.4.9.4	Critical Fusion Frequency	144
5.4.9.5	Spatial and Chromatic Effects	145
5.4.9.6	Models	146
5.4.9.7	Motion Sensitivity	146
5.4.9.8	Summary	147
5.4.10	Color Vision	147
5.4.10.1	Color Specification	147
5.4.10.2	Chromaticity Coordinates	148
5.4.10.3	Color Difference Metric	149
5.4.10.4	Opponent Color Representations	149
5.4.10.5	Spatial and Temporal Aspects of Color Vision	150
5.4.10.6	Anomalous Color Vision	150
5.4.10.7	Color Naming and Color Search	150
5.4.10.8	Color Context and Color Appearance	151
5.4.10.9	Summary	151
5.4.11	Other Visual Phenomena	151
5.4.11.1	Glare	151
5.4.12	Vision During Space Flight	151
5.4.12.1	Effects of Space Flight on Vision	151
5.4.12.2	Visual Environment in Space	152
5.4.13	Vision Correction	153
5.4.14	Mesopic vision	153
5.4.15	Research Needs	153
5.5	AUDITORY PERCEPTION	155
5.5.1	Introduction	155
5.5.2	The Nature of Sound	155

5.5.2.1	Sound Propagation	155
5.5.2.2	Sound Measurement	157
5.5.3	Auditory Response to Sound Intensity	158
5.5.3.1	Absolute Thresholds	158
5.5.3.2	Hearing Loss	160
5.5.3.3	Loudness	162
5.5.3.4	Loudness and Hearing Loss	164
5.5.3.5	Intensity Discrimination	164
5.5.4	Auditory Response to Sound Frequency	165
5.5.4.1	Frequency Selectivity and Masking	165
5.5.4.2	Frequency Selectivity and Hearing Loss	167
5.5.4.3	Frequency Discrimination	168
5.5.4.4	Pitch	169
5.5.5	Auditory Space Perception	169
5.5.5.1	Primary Localization Cues	169
5.5.5.2	Factors Affecting Localization Performance	171
5.5.6	Auditory Perception of Complex Multidimensional Sounds	173
5.5.6.1	Nonspeech: Auditory Pattern and Object Perception	173
5.5.6.2	Speech	175
5.5.7	Research Needs	176
5.6	COGNITION	178
5.6.1	Introduction	178
5.6.2	General Cognition	178
5.6.3	Human Cognitive Abilities	179
5.6.3.1	Reaction Time	180
5.6.3.2	Short-Term Sensory Register	182
5.6.3.3	Attention	182
5.6.3.4	Working Memory	185
5.6.3.5	Long-Term Memory	186
5.6.3.6	Problem-Solving, Reasoning, and Decision-Making	188
5.6.3.7	Creative Thinking	192
5.6.4	Space Flight Stressors	192
5.6.5	Cognitive Metrics	194
5.6.5.1	Cognitive Performance Tests	195
5.6.5.2	Test Validity, Reliability, Sensitivity, and Specificity	197
5.6.6	Quantitative Models of Human Cognition	197
5.6.6.1	Human Performance Models	198
5.6.6.2	Cognitive Models	199
5.6.7	Research Needs	200
5.7	COGNITIVE WORKLOAD	201
5.7.1	Workload Evaluation and Reduction in the System Development Cycle	201
5.7.2	General Description of Workload	202
5.7.2.1	Workload and Performance	202
5.7.2.2	Workload Demands and Resources	203
5.7.2.3	Single Versus Multiple Task Demands	205
5.7.3	Measures of Workload	205

5.7.3.1	Measures of Primary Task Performance	206
5.7.3.2	Measures of Secondary Task Performance	209
5.7.3.3	Measures of Physiological Functions	212
5.7.3.4	Subjective Rating	215
5.7.3.5	Workload Considerations	219
5.7.3.6	Conclusions: Workload Assessment	220
5.7.4	Predictors of Workload	221
5.7.4.1	Predictors of Workload: Table Lookup for Single Task	221
5.7.4.2	Predictors of Workload: Multiple Tasks	224
5.7.5	Establishing Workload Limits	229
5.7.5.1	Workload Limits for Single Task Demands	229
5.7.5.2	Workload Limits for Multiple Task Demands	230
5.7.5.3	Summary of Estimates of Workload Limits	231
5.7.6	Workload and Other System Factors	231
5.7.6.1	Workload and Training	231
5.7.6.2	Workload, Automation, and Situation Awareness	232
5.7.6.3	Workload Transition	233
5.7.6.4	Workload and Long-Duration System Operations in Extreme Environments	234
5.7.6.5	Workload and Stress	235
5.7.7	Research Needs	236
5.8	CREW COORDINATION AND COLLABORATION	237
5.8.1	Introduction	237
5.8.1.1	Definitions	237
5.8.1.2	Section Overview	239
5.8.2	Components of Effective Team Coordination and Collaboration	239
5.8.2.1	Shared Mental Models	239
5.8.2.2	Collaborative Decision-Making	241
5.8.2.3	Metacognitive Strategies	242
5.8.2.4	Adaptive Coordination Skills	243
5.8.2.5	Team Communication	243
5.8.2.6	Cohesion	244
5.8.3	Challenges to Effective Teamwork	245
5.8.3.1	Stressors in Space	245
5.8.3.2	Stress Effects on Teamwork and Performance	250
5.8.4	Supporting Effective Teamwork	252
5.8.4.1	Composing Crews	252
5.8.4.2	Training to Enhance Team Performance and Cohesion	258
5.8.4.3	Monitoring Tools	263
5.8.4.4	Technologies to Support Team Coordination and Collaboration	266
5.9	REFERENCES	270

TABLE of FIGURES

Figure 5.1-1.	Physical changes in 0g (Nicogossian et al., 1993)	103
Figure 5.4-1.	Threshold and the psychometric function.	129
Figure 5.4-2.	Pupil diameter as a function of light level and age	131
Figure 5.4-3.	Photopic and scotopic luminous efficiency functions.	132
Figure 5.4-4.	Relation between luminance and retinal illuminance for 4 ages.....	133
Figure 5.4-5.	Luminance range over which human vision operates.	135
Figure 5.4-6.	Contrast threshold as a function of target diameter (Blackwell, 1946)....	136
Figure 5.4-7.	Example acuity targets.	137
Figure 5.4-8.	Acuity vs. light level (Rabin, 1994).	137
Figure 5.4-9.	Sinusoidal grating targets varying in spatial frequency and contrast.	138
Figure 5.4-10	Contrast sensitivity functions for various light adaptation levels (van Nes & Bouman, 1967).	139
Figure 5.4-11	Spatial contrast sensitivity as a function of temporal frequency (Robson, 1966).	139
Figure 5.4-12	Contrast sensitivity for Gabor patterns as a function of eccentricity in cycles (Robson & Graham, 1981).	140
Figure 5.4-13	Spatial contrast sensitivity filter of the Spatial Standard Observer.	141
Figure 5.4-14	Contrast threshold for a 1° disk as a function of duration on various background light levels (Roufs, 1972)	143
Figure 5.4-15	Temporal contrast sensitivity function at various light levels (De Lange, 1958).....	144
Figure 5.4-16	Critical fusion frequency as a function of retinal illuminance for various wavelengths (Hecht & Shlaer, 1936).	145
Figure 5.4-17	Temporal contrast sensitivity at various spatial frequencies (Robson, 1966).....	146
Figure 5.4-18	CIE 1931 and 1976 chromaticity diagrams.	148
Figure 5.4-19	Spatial contrast sensitivity for luminance and chromatic modulation (Mullen, 1985).....	150
Figure 5.4-20	Refractive change in seven astronauts after long-duration space flight.	152
Figure 5.5-1.	A graphic representation of a sinusoidal sound wave	155
Figure 5.5-2.	Frequency weighting for dBA.	158
Figure 5.5-3.	Minimum sound levels that can be heard (Moore, 2004).....	159
Figure 5.5-4.	Examples of audiometric configurations.	161
Figure 5.5-5.	Equal-loudness contours for pure tones under free-field listening conditions (ISO 226:2003)	163
Figure 5.5-6.	Shape of the auditory filter as a function of level (2000 Hz sinusoidal input; Moore, 2004).....	166
Figure 5.5-7.	Bandwidth of auditory filters as a function of frequency (Moore, 2004).....	167
Figure 5.5-8.	Auditory filter shapes for a center frequency of 1 kHz (Moore, 2004)....	168
Figure 5.5-9.	Frequency discrimination as a function of frequency for a 200-ms pure tone (Plack, 2005).	169
Figure 5.5-10.	Primary localization cues.	171
Figure 5.5-11.	Representation of speech sounds.....	176

Figure 5.6-1.	Model of information processing (adapted from Wickens, 1992).	179
Figure 5.6-2.	Hierarchical levels of attention.	183
Figure 5.7-1	The effect of increasing task difficulty (or resource demand) from left to right on task performance	204
Figure 5.8-1	Group Diagrams of a unified group (left) and a polarized group (right).	264

TABLE of TABLES

Table 5.2-1 Percentile Values for VO ₂ max (mL/kg/min)	104
Table 5.2-2 Metabolic Workload During EVA.....	105
Table 5.2-3 Pre- and Postflight Musculoskeletal Data from <i>Mir</i> and ISS Missions 1-6 .	107
Table 5.3-1 Summary of Cockpit Design Considerations	117
Table 5.5-1 The Relationship Between SPL and Pressure Ratios for Typical Sound Examples	156
Table 5.5-2 Predictions of Hearing Loss – Reported as an Average of Hearing Thresholds at Four Frequencies: 500, 1000, 2000, and 4000 Hz) as a Function of Age (ACOEM, 2003).....	161
Table 5.6-1 Effects of Variables on Reaction Times	181
Table 5.6-2 Cognitive Biases	191
Table 5.7-1 Measures of Physiological Functions Used to Index Mental Workload (MWL).....	213
Table 5.7-2 McCracken & Aldrich Workload Demand Values.....	222
Table 5.7-3 Sources of Mental Workload	223
Table 5.8-1 Task and Relationship Conflict Correlated with Team Member Satisfaction and Team Performance in a 2003 Meta-Analysis	246
Table 5.8-2 Relationships Between Big Five Personality Factors and Team Performance in a Recent Meta-Analysis	253

5 HUMAN PERFORMANCE CAPABILITIES

5.1 INTRODUCTION

Like any other system component, humans have limits on their performance capabilities. System developers must be aware of these limits and must assign responsibilities and design systems so that humans work within their capabilities. Human perceptual capabilities include the abilities to see and hear. Cognitive capabilities include abilities to reason, remember, communicate, and understand. This chapter attempts to address multiple aspects of human capabilities and how those capabilities are altered during spaceflight. The reader should not assume that every topic related to human performance and the effect of spaceflight is covered in full detail and should search out other sources of information to supplement what is covered here.

5.2 PHYSICAL WORKLOAD

5.2.1 Introduction

The musculoskeletal and cardiorespiratory systems work in unison to perform activities of daily living and engage in physical activity of low to strenuous intensity. The ability to move heavy loads or perform long-duration endurance activities at a moderate to high intensity requires optimal functioning of these systems. Decrements in these physiological systems at a magnitude of 10% or more can severely reduce task performance. Exposure to microgravity causes adaptations to the cardiovascular system, muscles, and bones that can affect mission-critical task performance and increase the risk for injury upon return to 1g or other gravitational environments (Figure 5.1-1). The new “space-normal” statuses of these systems are different from Earth, and could increase injury risk during flight and when astronauts return to gravitational environments. As a countermeasure, crewmembers perform daily aerobic and resistance training sessions using exercise equipment to maintain pre-flight fitness levels. It is critical that exercise hardware be available to crewmembers for daily use during spaceflight – hardware that provides adequate intensity levels to maintain muscle, cardiovascular, and bone health.

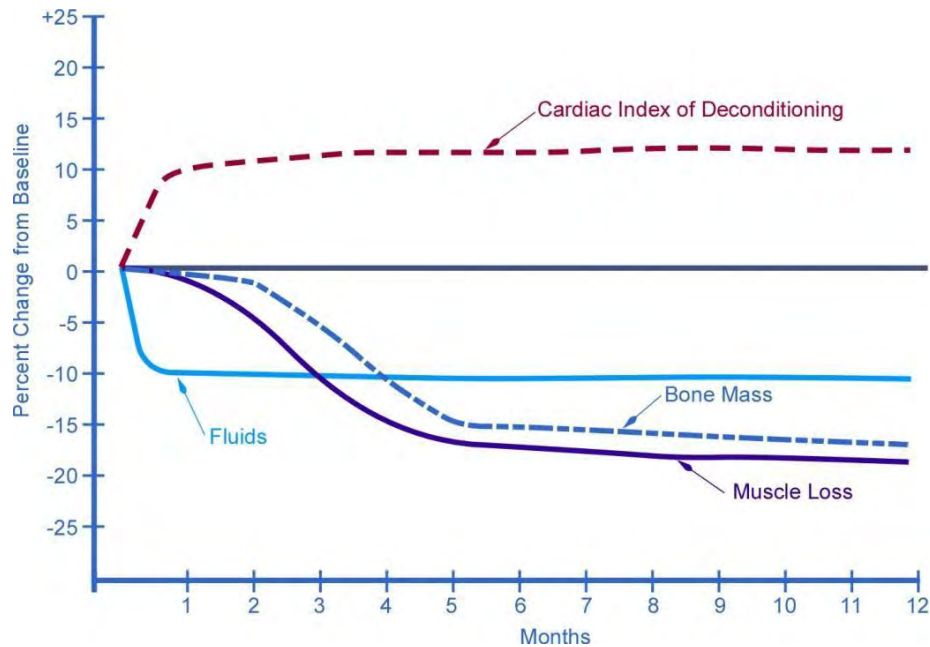


Figure 5.1-1. Physical changes in 0g (Nicogossian et al., 1993).

5.2.2 Aerobic and Cardiovascular Fitness

The cardiovascular system is made up of the heart, blood, and blood vessels, and is the major means by which fuel is delivered to the muscles and metabolic by-products are removed.

Aerobic fitness describes the overall efficiency of the cardiovascular system in delivering oxygen to muscles and the efficiency at which the muscle can use the oxygen to maintain prolonged submaximal work (e.g., running a marathon). The ability to deliver oxygen to the muscles depends on several physiological parameters including the volume of blood pumped from the heart to the working muscles, gas exchange between the blood vessels and the muscle, and the metabolic efficiency of the muscle. Maximal oxygen consumption or maximum aerobic capacity (VO_{2max}), maximal aerobic power, and lactate threshold are measures of cardiovascular fitness. VO_{2max} is expressed as the volume of oxygen used per unit time, and can be in absolute (L/min) or relative terms (mL/kg/min). Maximal aerobic power is the greatest amount of power generated at VO_{2max} . Lactate threshold refers to the highest exercise intensity that can be maintained for a prolonged period of time. Lactate threshold is a better predictor than VO_{2max} of an individual's ability to perform well in endurance events due to the ability to maintain a higher absolute workload for a longer time. Specifically related to spaceflight application, determination of lactate threshold could provide important information regarding readiness for extravehicular activity (EVA) tasks or exploration performance.

Table 5.2-1 shows VO_{2max} values for age and gender for different levels of aerobic fitness. Individual's ranking near or below the 20th percentile experience difficulty performing tasks of daily living and are at a higher risk for all cause mortality.

Table 5.2-1 Percentile Values for VO₂max (mL/kg/min)

Men:

Age	<u>20-29</u>	<u>30-39</u>	<u>40-49</u>	<u>50-59</u>	<u>60-69</u>
90 th Percentile	54.0	52.5	51.1	46.8	43.2
50 th Percentile	43.9	42.4	40.4	36.7	33.1
20 th Percentile	38.1	36.7	34.6	31.1	27.4

Women:

Age	<u>20-29</u>	<u>30-39</u>	<u>40-49</u>	<u>50-59</u>	<u>60-69</u>
90 th Percentile	47.5	44.7	42.4	38.1	34.6
50 th Percentile	37.4	35.2	33.3	30.2	27.5
20 th Percentile	31.6	29.9	28.0	25.5	23.7

ACSM Guidelines for Exercise Testing and Prescription, 6th ed., 2000. Note: These percentages were based on a modified Bruce treadmill protocol. Other types of maximal aerobic capacity testing may not be directly comparable to these values.

5.2.2.1 Aerobic/Cardiovascular Fitness Adaptations to Microgravity

Cardiovascular deconditioning during exposure to the weightlessness environment of space flight encompasses a wide array of physiological adaptations and subsequent functional consequences. Triggered by the absence of hydrostatic gradients, a cephalad fluid shift, and lower physical activity levels, cardiac work is reduced (Shibata et al., 2010); hence, there is a decreased reliance upon cardiovascular reflexes to maintain blood pressure and cerebral perfusion, and blood (Alfrey et al., 1996) and plasma volume (Frtisch-Yelle, et al., 1996; Leach et al., 1996) are reduced. Consequently, astronauts during and after microgravity exposure may experience decreased left ventricular mass (Perhonen et al., 2001), diastolic dysfunction (Dorfman et al., 2008), vascular dysregulation (Zhang, 2001), reduced exercise capacity (Levine et al., 1996; Moore et al., 2001, Trappe et al., 2006), reduced thermoregulatory responses (Fortney et al., 1998; Lee, et al., 2002), and orthostatic intolerance upon return to a gravity environment (Buckey et al., 1996; Fritsch-Yelle et al., 1996; Meck et al., 2004; Waters et al., 2002). Although some adaptations to space flight are rapid (e.g., reduced plasma volume) and do not appear to progress in severity (Platts et al., 2009), others may be exacerbated by longer exposures to weightlessness (Bringard et al., 2010; Dorfman et al., 2007; Meck et al., 2001), particularly when no or inadequate countermeasures are performed.

Cardiovascular deconditioning increases the risk of harm to the crew during and after space flight when it results in an inability of the astronauts to perform physically demanding tasks (e.g., planetary EVA, respond to an emergency (Bishop et al., 1999; Lee et al., 2010; Moore et al, 2010)) or maintain consciousness during acceleration or gravitational stress (re-entry and landing on Earth, deceleration when approaching and acceleration when departing from an extraterrestrial body (Platts et al., 2009; Stenger et al., 2010)). Thus, countermeasures have been adopted during flight (e.g., exercise) and immediately before return (e.g., fluid loading (Bungo et al., 1985)) or during return from spaceflight (compression garments and liquid cooling garments (Perez et al., 2003)) to minimize or prevent cardiovascular deconditioning or its consequences. Additional countermeasures, including artificial

gravity (Katayama et al., 2004; Lee et al., 2009; Stenger et al., 2012; Watenpaugh, et al., 2007), also are under investigation. It is estimated that aerobic capacity is reduced dramatically (~20%) in the first few weeks of space flight and slowly returns to near pre-flight levels throughout the mission. This dramatic reduction on VO₂max upon exposure to microgravity is likely due to a combination of factors including a rapid fluid shift and minimal usage of exercise countermeasures in the first week to 2 weeks upon arrival on the International Space Station (ISS). Upon landing and exposure to 1g, crewmembers experience an approximate 10% to 15% reduction in aerobic exercise capacity from pre-flight.

5.2.2.2 In-flight Aerobic Fitness Requirements

During Shuttle missions, EVA activity was generally low to moderate in intensity and ranged in duration from approximately 4-8 hours (Table 5.2-2). Additionally, some tasks required short bursts of higher intensity activity or high levels of absolute strength. Currently, it is not possible to identify a minimum aerobic fitness requirement for crewmembers to maintain during flight because the future EVA or explorations tasks have not yet been defined. However, it is expected that future exploration tasks will be even longer in duration and higher in intensity, and will require work in austere environments. Further, the additional costs of performing activities in a pressurized suit at different gravity levels and the stress of the situation are not known. As such, there are significant implications of a 20% reduction in aerobic fitness on the ability to perform EVA or extravehicular mission-critical tasks. It is critical for crewmembers to maintain aerobic fitness at or near pre-flight levels.

Table 5.2-2 Metabolic Workload During EVA

Mission	kcal/h, L/min
Apollo (1/6g)	234 kcal/h, 0.80 L/min
Apollo (0g)	151 kcal/h, 0.51 L/min
Skylab	238 kcal/h, 0.81 L/min
Shuttle (STS 1-54)	205 kcal/h, 0.76 L/min
Shuttle (STS 103-121)	220 kcal/h, 0.76 L/min

5.2.2.3 Exercise Countermeasures for Aerobic/Cardiovascular Fitness

The American College of Sports Medicine (ACSM) recommends a minimum of 30 to 60 minutes of moderate to vigorous aerobic activity (70% to 85% of maximum heart rate) five times per week and 2-3 days per week of resistance training to maintain cardiovascular health for normal healthy individuals in a 1g environment. Research shows that high intensity interval exercise most efficiently improves or maintains aerobic fitness across age ranges, genders, and fitness levels. Generally, interval training should include repeated bouts of high intensity exercise (ranging from 85% to supra-maximal) for 30 seconds to 4 minutes. The rest time should be equivalent to or less than the work time. This ground-based evidence strongly suggests that the availability of exercise countermeasures that allow for performance of high-intensity interval and continuous aerobic exercise are critical for astronauts to maintain cardiovascular health and aerobic fitness. Those with greater levels of initial fitness require higher training intensities; therefore, it is not possible to precisely identify a training intensity threshold either for improving performance or for managing cardiometabolic risk factors. There is some evidence that moderate to vigorous aerobic exercise has positive effects on mental health, particularly depression.

5.2.3 Muscle

The musculoskeletal system is composed of the muscles and bones in the body. Muscles are the force-producing tissue in the body, whereas bone is the structural tissue. Skeletal muscle is essential to human health and functional performance as both a contractile tissue responsible for force production and a metabolically active system with an indispensable role in glucose and amino acid metabolism.

Muscles can be activated in a concentric, eccentric, or isometric manner, and each type of muscle action is important for normal body motions.

- Concentric muscle actions – The muscle shortens while producing force. For example, your biceps muscle shortens while producing force when you pick up a glass of water and move it toward your mouth.
- Eccentric muscle actions – The muscle lengthens while producing force. For example, the biceps muscle lengthens while producing force when you lower a glass of water from your mouth to a table. In general, eccentric muscle actions are used to lower items or loads.
- Isometric muscle actions – The muscle creates tension, but the muscle does not change length. For example, the biceps muscle is activated isometrically when you hold a glass of water at your side, with your elbow bent at a 90° angle.

5.2.3.1 Muscle Adaptations to Spaceflight

Mechanical unloading, an inherent feature of microgravity environments, results in a loss of muscle mass and muscle strength. These alterations originate at the molecular level where down-regulation of anabolic pathways leads to a reduction in muscle protein synthesis that effects a decrease in muscle fiber cross-sectional area. The resulting strength decrements are a by-product of both the decreased muscle mass and neural adaptations that result in poorer activation of motor units.

Additionally, with prolonged inactivity (such as bed rest), muscles lose their ability to sense insulin; this impairs muscle metabolism and causes potentially harmful elevations in circulating sugars. An extreme example of this is seen when people are forced (or choose) to become completely sedentary: they lose significant muscle mass, the muscle mass that remains becomes insensitive to insulin, and they develop type II diabetes, a serious health concern. Insulin insensitivity occurs during space flight analogs (i.e., bed rest; Pavy-Le Traon, et al., 2007). Therefore, insulin insensitivity is a health concern during long-duration space flight.

When data from *Mir* and ISS missions were pooled, it was observed that whole-body lean mass was reduced after long-duration space flight (Table 5.2-3; Lee, et al., 2004). Similarly, crewmembers had lower leg lean mass, knee extension peak torque, and knee flexion peak torque after both *Mir* and ISS missions than before each mission.

Table 5.2-3 Pre- and Postflight Musculoskeletal Data from *Mir* and ISS Missions 1-6

	Whole-Body Lean Mass (kg)		Leg Lean Mass (kg)		Knee Extension, Peak Torque (N-m)		Knee Flexion, Peak Torque (N-m)	
	Pre	Post*	Pre	Post	Pre	Post	Pre	Post
<i>Mir</i>	60.5±1.6	58.4±5.5	19.6±0.7	18.3±0.9*	179±17	131±16*	103±12	79±10*
ISS	56.1±2.9	54.9±3.4	18.7±1.0	18.0±1.3*	176±10	136±10*	106±6	74±7*

Note: Data are represented as means ± standard deviation. *Significant ($P < 0.05$) change from before flight to after flight (Lee et al., 2004).

Most mass and strength losses occur in the locomotor and postural musculature of the trunk and lower extremities. Strength in these muscles groups declines 8% to 17% following a 6-month stay on the ISS.

5.2.3.2 Muscular Fitness Requirements

No quantitative standards exist for muscle strength during spaceflight, only that countermeasures must be used to maintain skeletal muscle strength at or above 80% of baseline (pre-flight) values (NASA-STD-3001, Volume 1). A qualitative understanding of the strength requirements for spaceflight muscle strength loss is problematic from both an individual and an operational standpoint. Upon return to Earth's gravity, astronauts may be at increased risk for falls and/or may experience difficulty with activities of daily living. Operationally, high strength levels are needed both during spaceflight (e.g., to free jammed hardware, or to move large mass objects) and during emergency egress from a vehicle, which would likely involve high force activities such as opening a hatch, raising oneself and other crewmembers out of the vehicle, and running from the vehicle, all performed while wearing a bulky, heavy space suit. Thus, it is clear that high strength levels are desirable both for the performance of routine tasks in space and for the safe egress from a vehicle during an emergency. Also see HIDH Chapter 4.7.3 for information on the application of strength data.

5.2.3.3 Exercise Countermeasures for Muscular Fitness

Inflight exercise countermeasures have been employed from early Skylab missions through current ISS expeditions. Resistance exercise is the primary countermeasure used to prevent spaceflight-induced muscular deconditioning. Research suggests that high intensity resistance exercise with a 1:1 (or greater) ratio of eccentric:concentric loading is optimal to increase or maintain strength.

The interim resistance exercise device (iRED) was in use on the ISS through 2008; it provided a 136 kg maximum load with a ~70% loading ratio. iRED's variable resistance is provided by elastic, polymer-based bands that are stretched as an exerciser raises a lifting bar. Because the mass of an exerciser contributes very little resistance (only some inertia) during exercise (e.g., squats) in microgravity, resistance exercise devices must provide rather high levels of loading. For instance, to provide an in-flight loading similar to a 90-kg crewmember that squats his bodyweight during 1g exercise, a resistance exercise device employed in a microgravity environment must provide ~180 kg of loading. Thus, iRED was unable to provide adequate high intensity loading for most crewmembers. Also, iRED's low eccentric loading was substantially less than that offered by free weights in a 1g environment.

The Advanced Resistive Exercise Device (ARED) was designed, built, and deployed on the ISS during Expedition 18 in 2009, particularly to increase the exercise intensity of the hardware. ARED provides up to 273 kg of loading – more than enough for the typical crewmember. Using the example above, a 90-kg crewmember would be able to exercise with up to 183 kg of resistance above the amount that would be required to replace body weight. Additionally, ARED provides ~90% of the concentric load during the eccentric phase of exercise and uses flywheels to replicate the inertia experienced during exercise in normal gravity. Not surprisingly, losses in knee extensor strength and endurance in astronauts who use ARED are about half of those observed in astronauts who used iRED during their mission. For more information on Exercise Countermeasures, please see Chapter 7.5.

General guidelines for improving each characteristic of skeletal muscle in 1 G:

- Muscle size
 - Mode of exercise: resistance exercise
 - Choice of exercise: exercises that involve large amounts of muscle mass (e.g., squat, dead lift, bench press)
 - Intensity: moderate (60% to 80% of 1 repetition max or a load that can be lifted 8 to 12 repetitions) to heavy (>80% 1 RM) exercise loads
 - Volume: multiple sets per exercise (i.e., 3 to 5 sets) and 6 to 12 repetitions per set
 - Rest periods: ~2 to 3 minutes of rest between sets
 - Frequency: 2 to 3 times/week
- Muscle strength
 - Mode of exercise: resistance exercise
 - Choice of exercise: exercises that involve large amounts of muscle mass (e.g., squat, dead lift, bench press)
 - Intensity: very heavy exercise loads (near maximal)
 - Volume: multiple sets per exercise (i.e., 3 to 5 sets) and 1 to 6 repetitions per set
 - Rest periods: ~3 minutes of rest between sets
- Muscle power
 - Mode of exercise: resistance exercise
 - Choice of exercise: exercises that involve large amounts of muscle mass and that can be performed rapidly (e.g., power clean, squat jump, push press)
 - Intensity: moderate exercise loads; perform the exercise as fast as possible
 - Volume: multiple sets per exercise (i.e., 3 to 5 sets) and 1 to 6 repetitions per set
 - Rest periods: ~3 minutes of rest between sets
- Muscle endurance
 - Mode of exercise: resistance exercise or endurance exercise
 - Choice of exercise: exercises that involve large amounts of muscle mass (e.g., squat, dead lift, bench press)
 - Intensity: light (<50% 1RM) to moderate loads
 - Volume: 2 sets with 15 to 25 repetitions per set
 - Rest periods: 2 to 3 minutes of rest between sets

5.2.3.4 Maintenance of Muscular Fitness

An ACSM position statement reviewed research related to the amount of exercise required to maintain fitness in 1g. It is generally believed that, in 1g, more exercise is required to improve fitness than to

maintain fitness. Among intensity, duration, and frequency of exercise, intensity is the most important factor – especially for maintenance of aerobic fitness. With respect to resistance training, the ACSM review notes that muscle strength and power are particularly vulnerable to loss of training adaptations and quickly reverse when training stops. Again, intensity seems to be the key component of maintaining the effects of resistance training.

During future exploration missions, the challenge for exercise countermeasures to spaceflight-induced losses of muscle mass and strength will be primarily the spatial limitations of the crew exploration vehicle. A 6-month, one-way trip to Mars in a small capsule will afford only a small volume both for the exerciser and the exercise device. The goal of having a resistance exercise device that is located onboard during space exploration missions and that provides high resistance, excellent eccentric loading, and inertial loading similar to free weights, represents a significant challenge.

5.2.4 Bone

The skeletal system provides a variety of functions including forming the body's basic shape and structure, providing leverage for directed movement by the muscles, protecting body organs, producing blood cells, and storing minerals. Normal healthy bone is continuously broken down and rebuilt to maintain a state of homeostasis. Osteoporosis is a disease defined by a net decrease in bone mineral density (BMD), which leads to an increased risk for bone fracture. Osteoporosis is typically treated with a combination of bone loading physical activity (i.e., resistance training) and pharmaceutical interventions (i.e., bisphosphonates). Post-menopausal women and the elderly are at high risk for osteoporosis due to changes in hormone levels and reductions in physical activity.

5.2.4.1 Bone Adaptations to Spaceflight

Astronauts experience decrements in bone mineral density during long-duration spaceflight at a rate of 1.0% to 1.5% per month, which is significantly more rapid (~10 times faster) than osteoporotic individuals in 1g (Shackelford 2004). The rate of loss is different among body locations and is particularly high in the hip. Additionally, there is evidence that bone micro-architecture changes as a result of spaceflight. These changes are concerning for astronauts participating in ISS missions due to increased susceptibility to fracture when an external load is applied or if an unexpected load is applied, such as a trip and fall in 1g. These risks are elevated for future exploration missions where astronauts may be exposed to microgravity for more than a year. Of further concern is the fact that not all of the BMD lost during spaceflight is regained and bone micro-architecture may not recover, which provides an increased risk for early onset osteoporosis and fracture risk later in life.

5.2.4.2 Exercise Countermeasures for Bone

According to Wolff's Law, bone will adapt to the load it is placed under. As such, exercises that provide a high ground reaction force and loading to the skeletal system such as resistance exercise, high speed running, and plyometrics are prescribed to prevent losses in bone mineral density. Specifically, exercise regimes aimed at maintaining bone health suggest frequent and diverse load application with a high strain rate (i.e., resistance training, treadmill running). Recent research has indicated that bone best responds to loads that are applied in a cyclic manner, create a high rate of change of force, and when bone loading exercise bouts are best separated over a period of time (Turner, 1998).

It is expected that the loading stimulus will need to be greater and more frequent in microgravity than in 1g to account for the lack of daily bone loading that is experienced on Earth during normal ambulation. These bone loading requirements are difficult to achieve in a microgravity environment due to limitations of exercise equipment and crew schedule constraints. However, it is critical for crewmembers to have frequent access (potentially multiple daily sessions) to exercise equipment that can provide high levels of loading, and diversity in load application, on the skeletal system. These exercise countermeasures should be targeted primarily toward protecting the lower body and hip regions.

5.2.5 Summary

The microgravity-induced adaptations to the cardiorespiratory and musculoskeletal systems cause a decrease in aerobic exercise capacity, muscle strength, and BMD. Reductions in these fitness and strength parameters can have severe implications on astronaut readiness and ability to perform EVA tasks, future exploration tasks, off-nominal landing scenarios, and tasks of daily living upon return to 1g. Astronauts need to perform daily sessions of high-intensity aerobic exercise and high load resistance exercise during spaceflight to mitigate losses in aerobic fitness, muscle strength, and bone health, and to reduce injury risk.

5.2.6 Research Needs

The following areas have been identified as needing further study:

- Risk of bone fracture.
- Risk of early onset osteoporosis due to spaceflight.
- Risk of impaired performance and injury due to reduced muscle mass, strength, and endurance.
- Risk of injury from dynamic loads.
- Risk of reduced physical performance capabilities due to reduced aerobic capacity.

5.3 SENSORIMOTOR FUNCTION

5.3.1 Introduction

A key component of human performance in aerospace tasks is the transformation of sensory information about the environment into appropriate motor commands to effect the proper action, such as sensing an aircraft's acceleration and orientation in order to maintain level flight. The combination of inputs from various senses — visual, vestibular, auditory, haptic (pertaining to touch), and proprioceptive (perceiving the movement or position of the body) — in conjunction with motor control output signals are all integrated to generate the timely, accurate, and precise sensorimotor responses needed for the safe and effective performance of tasks such as flight control, teleoperations, and system monitoring and intervention. A space mission includes multiple and changing environments that not only distort the three-dimensional (3D) perception of the environment and of one's own position and motion, but also interfere with the proper implementation and coordination of needed control actions. Furthermore, after extended exposure to altered gravitational and other environmental conditions, physiological adaptation processes make the situation more complicated, as these changes can end up maladaptive during and after g-transitions such as descent and entry. The induced environments and associated physiological

changes represent significant challenges to the crew's ability to perform their tasks, especially during dynamic phases of flight.

The unfamiliar or conflicting sensory inputs from space flight environments may lead to

- Spatial disorientation
- Altered oculomotor function and degraded active vision
- Compromised manual control
- Balance and locomotion deficits

To support proper vehicle control and crew safety, human-vehicle systems must be designed to enable adequate sensorimotor function in the face of these challenges, and to identify and mitigate sensorimotor dysfunction when it occurs.

5.3.2 Perceptual and Motor Performance

Humans have specialized visual and vestibular sensory systems that process both static and dynamic signals related to one's angular position and motion with respect to the environment, as well as the angular tilt and motion of external reference objects. In most cases, these sensory signals limit perceptual precision as well as voluntary sensorimotor control, either directly or indirectly through their inputs to gaze and postural stabilization reflexes.

With respect to sensorimotor performance, these are the key human perceptual capabilities and limitations:

- The human visual system is capable of estimating two-dimensional (2D) static angular orientation of objects with a precision better than 1° , although performance depends on stimulus size and contrast (Howard & Templeton, 1966; Philips & Wilson, 1984).
- The human vestibular system has a specialized tilt processing system, based primarily on the output of the otoliths, which on Earth signal the angular position of the head with respect to gravity with a precision of about 1° (Howard & Templeton, 1966). The ambiguity in otolith afferents between linear accelerations arising from tilt with respect to a gravitational vector and translation motions is resolved using both the frequency content of the stimulus signal and the input from other sensory systems (Mayne 1974). A peak in motion sickness susceptibility occurs during linear accelerations around 0.1 to 0.3 Hz due to frequency segregation being inadequate to distinguish between tilt and translation (Wood 2002).
- Thresholds for perception of whole-body translation are significantly higher in the vertical direction ($\sim 0.15 \text{ m/s}^2$) than thresholds for movement in the horizontal directions ($\sim 0.06 \text{ m/s}^2$) (Benson et al., 1986).
- The human visual system can compute precise estimates of the 2D motion of objects on a display with the precision of speed estimates being as good as 5% (McKee et al., 1986) and of direction estimates better than 1° (Pantle & Sekuler, 1969). Again, however, performance depends on stimulus size, contrast, direction, and training (Pantle & Sekuler, 1969; Ball & Sekuler, 1987; Watamaniuk & Sekuler, 1992; Stone & Thompson, 1992; Krukowski et al., 2003). Furthermore, the biases and limitations in the perceptual processing of 2D visual motion have been shown to shape and limit the accuracy and precision of motor performance in both gaze (Kowler &

McKee, 1987; Stone & Krauzlis, 2003; Krukowski & Stone, 2005) and manual control (Li et al., 2006) tasks. In particular, below 16% contrast, for every twofold reduction in luminance contrast, there is a 35-ms increase in reaction time and an 8% increase in root mean square error in a manual control task (Li et al., 2005) mirroring the known perceptual underestimation of target speed (Stone & Thompson, 1992).

- The human visual system can compute precise estimates of one's 3D direction of self-translation (heading) from the visually expanding "optic flow" with an accuracy and precision approaching 1° (Warren et al., 1988). However, the accuracy and precision of visual heading estimation during passive perception of or active control of combined translation and rotation is three to four times worse and is sensitive to the field of view and to the amount of depth variation across visible points (Stone & Perrone, 1997; Li et al., 2007; Peng et al., 2008). The monocular perception of 3D translation closing speed and, thus, time-to-contact is expected to be limited by the 5% to 10% precision of 2D speed estimation (slightly better than 10% precision and looming in time-to-contact was empirically observed by Regan and Hamstra, 1993). However, the binocular stereomotion estimate of 3D closing speed from interocular-velocity-difference and changing-disparity cues are less precise, typically 25% or higher (Brooks & Stone, 2004), with two eye views actually being worse than one, due to stereomotion suppression whereby the added depth information comes at the expense of a loss in motion information (Brooks & Stone, 2006).

These are the key visual and vestibular gaze-stabilization mechanisms that support voluntary sensorimotor control:

- The vestibulo-ocular reflexes (VOR) help to keep gaze stabilized on an object during head motion to preserve high-acuity vision. When the head rotates, head velocity signals allow the oculomotor system to rapidly (latency: ~10 ms) stabilize the eyes to effectively keep visual images stable on the retinal fovea over a wide range of motion frequencies from below 0.2 Hz up to about 12 Hz (Ramachandran & Lisberger, 2005). There are three different forms of VOR:
 - The rotational VOR (RVOR) or angular VOR (AVOR) generates dynamic eye yaw, pitch, or roll compensations for head rotation using primarily angular velocity signals from the vestibular semicircular canals. However, the roll and pitch RVORs also receive otolith contributions.
 - The translational VOR (TVOR) or linear VOR (LVOR) provides dynamic eye yaw, pitch, and vergence compensation for head translations in the inter-aural (IA), dorso-ventral (DV), and naso-occipital (NO) axes, respectively, using linear velocity signals from the vestibular otolith organs. The TVOR seems to be modulated by canal inputs that help disambiguate IA (side-to-side) translation from roll tilt and NO (front-to-back) translation from pitch tilt (Angelaki et al., 1999). However, a simple frequency-based filtering disambiguation clearly plays an important role in both vestibular-based motion perception and the associated TVOR response (Merfeld et al., 2005), with frequencies above 1Hz predominantly interpreted as translation and frequencies below 1 Hz as tilt (as originally proposed by Paige and Tomko, 1991; Paige and Seidman, 1999). The TVOR depends strongly on gaze direction and vergence angle, so that it plays a more critical role in gaze stabilization for near viewing (Paige et al., 1998).
 - The ocular counter-roll (OCR) reflex compensates for static head roll tilts using gravitational signals from the vestibular otoliths. The otoliths estimate the tilt angle of

the head with respect to the gravito-inertial axis, and the oculomotor system generates a compensatory torsional eye movement that rolls the eyes in the opposing direction to allow some gaze stabilization. The gain of the OCR is only about 10% to 30%, so it does not fully compensate for head roll (Howard & Templeton, 1966).

- The optokinetic reflex (OKR) and other ocular-following reflexes help keep gaze stabilized during slow head motion. When the head rotates or translates slowly, large-field visual image motion signals allow the oculomotor system to stabilize the eyes to keep visual images stable on the retinal fovea over a low-pass range of motion frequencies. The OKR (which dominates at low speeds and frequencies below ~ 0.5 Hz) and the VOR (which dominates at higher speeds and frequencies above ~ 0.5 Hz) act in concert to accurately stabilize the retinal image over a wide range of head and self-motion speeds and frequencies.
- The vestibulospinal reflexes (VSR) act to maintain posture and balance. In response to a head and body tilt to the left (right), VSR responses extend the left (right) limbs and flex the right (left) ones to oppose the perturbation. The VSR is directly affected by 0g, as it relies on vestibular responses to gravitational cues to maintain balance and posture in 1g. While the concept of balance means little in 0g, postflight ataxia due in part to maladapted VSRs may pose a significant risk during vehicle egress after landing, especially after extended exposure to 0g.
- The vestibulocollic reflex (VCR) helps to gyroscopically stabilize the head by generating compensatory head movements in response to torso movements. The VCR may not be helpful in 0g, as torso movements in 0g do not require the same postural readjustments as would be required on Earth. Upon entry and landing, however, a maladapted VCR may compromise the ability to maintain head position during locomotion.

The above critical visual-vestibular signals and reflexes are all, to some extent, adversely affected during space flight. During dynamic phases of flight, in addition to the health and safety implications of elevated g loading and vibration, sustained and random acceleration can disrupt gaze stabilization and visual function and, together with the associated biomechanical perturbations of the limbs, can also compromise manual control performance (Paloski, et al., 2008). Upon initial orbital insertion at 0g, one's Earth-based vestibular reflexes are initially inappropriate for gaze stabilization. This can hinder visual function and motor control in the first day or so of flight, and can contribute to space motion sickness (SMS). The 0g environment then drives adaptive perceptual, motor, and proprioceptive processes and retunes the above reflexes, and also drives low-level physiological processes that alter muscular and cardiovascular function. Upon gravitational reloading, one's space-tuned visual-vestibular reflexes are initially inappropriate, leading once again to compromised gaze stabilization; one's space-tuned perceptual interpretations of visual signals are initially inappropriate, leading to illusions of self-motion and spatial disorientation; and one's space-tuned motor control systems (manual and postural) are initially inappropriately tuned for weightless limbs and body, leading to an increased likelihood of motor errors, postural deficits, and ataxia (Reschke et al., 1999), with the added complication that muscular strength and cardiovascular function are also compromised (see sections 5.2.2.2 and 5.2.2.1). This situation amplifies the adverse impact of the postflight neurovestibular dysfunction.

5.3.3 Spatial Disorientation

The information for maintaining spatial orientation is provided by simultaneous inputs from the visual, vestibular, somatosensory, and, occasionally, auditory systems. Spatial disorientation (SD) can occur if

unfamiliar inputs are presented to any of these systems, which often occurs regardless of head movements during sustained linear acceleration with limited visibility (e.g., Benson, 1990) and with additional Coriolis and cross-coupling effects induced by rotation artifacts during centrifugation (Young et al., 2003), or during head movements on initial exposure to 0g or on returning to elevated gravity conditions after adapting to an extended exposure to 0g (Glasauer & Mittelstaedt, 1998; Harm et al., 1999).

5.3.3.1 Acceleration and Hypergravity Effects

SD during atmospheric flight often occurs as a result of rotational motion or linear acceleration with poor visual feedback. During a sustained turn or acceleration, a “somatogravic illusion” may occur, which is the sensation of level flight while in a constant bank, of a nose-up attitude during sustained acceleration, and the apparent nose-down attitude sensed with deceleration.

When tilting the head during a sustained turn in flight, SD and motion sickness may occur. As a general rule, a head movement made in one axis (roll) after rotating for some time about an orthogonal axis (yaw) produces an illusory sensation in the third orthogonal axis (pitch) (Benson, 1990).

Because vision is so reliable for maintaining orientation, a pilot can still maintain correct orientation with misleading vestibular cues as long as visual cues are good. A consequence of poor or absent visual information is that vestibular suppression, which is the process of visually overriding undesirable vestibular sensations, does not occur. An example of this is seen in figure skaters who can learn to eliminate the post-rotatory dizziness that normally results from the high angular decelerations associated with suddenly stopping their rapid spins on the ice. But even these individuals experience the dizziness expected from their rotation when deprived of vision by eye closure or darkness. As is the case with figure skaters, a pilot’s ability to prevent vestibular sensations is compromised when the pilot is deprived of visual orientation cues, during instrument flight or when looking away from the instruments (Gillingham & Wolfe, 1985). Therefore, under limited visual conditions, vestibular cues must assume the role of perceiving body orientation, but may be incorrect and give a misleading perception of spatial orientation.

Also, in the absence of good visual cues, transient and sustained motions are unlikely to be detected if the change in angular velocity is less than a certain threshold. Mulder’s constant, which describes this threshold, is approximately 2° per second, and remains fairly constant for stimulus times of about 5 seconds or less (Gillingham & Wolfe, 1985). Piloting a spacecraft during entry after a space flight could include all of the perception and orientation errors associated with conventional aircraft flight, as well as introduce the added complication of having crewmembers who are adapted to a different gravity environment, a condition that can lead to sensory misinterpretation, hypersensitivity to head movement, and illusions of self-motion. In addition, atmospheric entry may dictate a flight profile with a high deceleration phase coupled with simultaneous multi-axis accelerations, thereby creating other unique sensory problems.

Hypersensitivity of the vestibular system during entry and landing from space flight, as a result of adaptation to 0g, has been noted during several Space Shuttle flights. Entry loads of ~0.5g are often reported to feel more like 1g or 2g; after landing, small pitch or roll motions of the head are perceived as being much larger angles, and head tilts are perceived as translations (Parker et al., 1985; Reschke & Parker, 1987; Young, 2000).

Almost all astronauts experience illusions of self-motion and surround motion, during both the 0g and the entry and landing phases of space flight, with illusion intensity proportional to the length of time on orbit. Individual experiences vary, but three types of disturbances in self- and/or surround motion are commonly reported:

- Gain disturbances – perceived self-motion and surround motion seems exaggerated in rate, amplitude, or position after head or body movement. One astronaut reported that head or body movements made in any axis during entry and immediately after landing were perceived as being five to ten times greater than the actual physical movement. Another crewmember reported that a 20° roll head movement resulted in perceived surround roll motion of 70° to 80°. At wheels stop, one crewmember reported that the 20° head movement was perceived as 0.6 to 0.9 m of self-translation (Reschke et al., 1996).
- Temporal disturbances – the perception of self-motion or surround motion either lags behind the head or body movement, persists after the real physical motion has stopped, or both. One astronaut who made pitch head movements daily for the first 3 days of flight reported that perceived self-motion lagged the real pitch head movement and persisted after the head movement stopped. Lag and persistence times were approximately equal, and both increased over the first 3 days of flight from barely perceptible to 0.5 seconds. This subject also reported that lag and persistence were most marked during the 1.5g phase of entry (Reschke et al., 1996).
- Path disturbances – angular head and body movements elicit perceptions of linear and combined linear and angular self-motion or surround motion. These perceptual disturbances seem to be most intense during atmospheric entry and immediately after wheels stop, as opposed to during flight (Harm et al., 1994).

Given the opportunity for SD to occur during entry and landing, any spacecraft that will be piloted during those phases, either as the primary method of control or as a backup to automation, must be designed to minimize sensorimotor disturbances in conjunction with other relevant mission and human constraints.

5.3.3.2 Acceleration and Hypergravity Countermeasures

5.3.3.2.1 Cockpit Layout

Several cockpit design factors influence the occurrence of SD. The first tool for maintaining orientation during the complex task of flying is the wide array of information available in the cockpit that enables the pilot to understand the direction and position of the vehicle. This information is conveyed visually from the outside environment via windows and from inside the vehicle via various instruments or displays.

External Views – Since vision is the most valuable sense for maintaining orientation, the first design consideration should be optimal location of windows and displays to provide adequate visual cues for piloting that are consistent with vestibular and tactile cues, and to reduce Coriolis stimulation of the semicircular canals during head movement, which can cause disorientation and motion sickness. A cockpit that allows both forward and peripheral views of the horizon would provide the best visual cues for maintaining spatial orientation during a piloted landing phase. Window views, or stereoscopic displays, that allow proper depth perception provide more accurate visual cues than 2D representations of the environment from a single camera view.

Instruments and Displays – As the complexity of the vehicle increases, so does the need to rely on additional information provided by the cockpit displays, which can partially replace degraded visual information and provide navigation information, as well as indicate the health and status of the vehicle. Even with all of this information available, and sometimes because of it, there are opportunities for SD to occur. Even in visual meteorological conditions (VMC) where the pilot can clearly see the environment through the window, some displays are still relied on for safe flying, thus requiring continual shifting of attention from outside to inside the vehicle. Frequent head movements associated with this continuous scanning, especially during turns or high-g maneuvers, can induce the orientation illusions mentioned previously and also give rise to motion sickness. The multiple displays that provide various pieces of information to the pilot should be designed to be simple to interpret, and should be located together according to function. Grouping related displays together allows efficient display scanning and minimizes unnecessary head movement. In general, displays should be positioned in the direction of motion, with axes of motion as similar to those of the vehicle itself as possible. A heading indicator that is placed off to one side of the cockpit instead of straight ahead may provide correct information, but since it is located in a position that is not aligned with the vehicle motion, it will require increased head movement to read, as well as more thought and concentration to interpret. Displays must also be large enough to allow quick and accurate understanding. The small cockpit size of the F-16 aircraft required a drastic reduction in display size, resulting in suboptimal line of sight for a rapid recovery from SD (McCarthy, 1990).

Controls – The design of vehicle controls can also play a role in helping maintain spatial orientation. To be the most intuitive, a control should move in a direction similar to that of the resulting vehicle motion. For example, moving the control stick to the right should also move the vehicle to the right (right roll), and pulling the stick back should tilt the vehicle backward (upward pitch). This may seem an obvious point, but with today's "fly-by-wire" technology in which control devices are not physically connected to control surfaces, any input in any direction can move any control surface via computer interface. To ensure that the pilot responds in an expected manner, the location, size, and displacement of controls should also be standardized to a sufficient degree that flying skills acquired in one type of vehicle can be retained and transferred to other types. Critical switches, levers, and controls must also be safeguarded against inadvertent operation. Especially during emergency conditions, where response time is critical, control of the vehicle must be intuitive.

Seat Position – Individuals who have been in NASA's Remote Cockpit Van have reported getting sick and disoriented in the fully-reclined position (body and vehicle x-axes 90° out of phase) during vehicle motion, with symptoms being reduced as the seat angle was raised (Fox, 2003). Depending on the location of windows and displays, recumbent seating might also limit visibility. One option to minimize vestibular disturbances during a piloted landing phase is to ensure that the vehicle cockpit provides visual, vestibular, and tactile cues to the pilot that are as "normal" as possible. Minimal vestibular disturbances would likely occur with the crew facing the direction of travel (in a near-upright position for a plane-like design), which is most familiar to pilots, with symptoms increasing as a function of decreasing seat tilt. It is possible to maintain the head in a forward-facing position to provide proper vestibular cues, and have the body in a reclined position to counteract cardiovascular and impact problems. However, reclined seating would affect tactile cues, and upright seating may prevent the perception of self-motion and tilt.

5.3.3.2.2 Cockpit Technology

It has been demonstrated that cockpit displays provide information about an aircraft's motion and orientation, yet at the same time can also provide disorienting cues. Therefore, some nontraditional cockpit and display technologies have been developed specifically to help counter SD. Examples of these are described below:

Three-Dimensional (3D) Audio – Audio inputs of this type may include verbal commands for recovering from an SD incident, as well as a continuous tone indicating a specific direction such as gravitational “up” or “down.” Research on multiple processing resources has revealed that the auditory modality can process information in parallel with vision, and therefore should be able to support spatial orientation in an otherwise visually loaded or impaired environment (Wickens, 2002). The advantages of using a 3D audio device include not only the primary information conveyed in the signal itself, but also relevant directional information, depending on the virtual source of the sound in the headset. However, it should be noted that hearing is inherently less capable of providing spatial information than vision (Wickens et al., 1983).

Tactile Displays – Research has been conducted using several different types of tactile display systems in conjunction with traditional displays to provide orientation information. The tactile situation-awareness system developed by the U.S. Navy has shown to be a promising nonvisual tool for avoiding SD by allowing the pilot to sense the aircraft's attitude nonvisually (Rupert, 1999; Rupert et al., 1994). It does so using arrays of small pneumatically activated tactile stimulators, incorporated into a vest, that are cued by the aircraft's inertial reference system.

Automation – One design strategy for minimizing the negative effects that space flight may have on a crewmember's ability to pilot a vehicle is to increase automation to reduce the amount of pilot control needed. Given the likely complexity of an entry vehicle, some use of automation is likely, especially during descent and landing sequences. In spite of the benefits, cockpit automation also imposes costs, frequently expressed in the form of accidents and incidents attributed to a breakdown in coordination between the pilot and automated systems (Billings, 1997). Therefore, if automated systems are to be used, the amount and type of automation should be carefully considered (see section 10.13, “Automated Systems”).

Table 5.3-1 Summary of Cockpit Design Considerations

<p>Cockpit Design Field of view – full (forward and peripheral) Crew position – head and body facing motion Instruments and displays – in line with motion Controls – intuitive, in line with motion</p> <p>Technology & Training 3D audio Tactile displays Automation (phase- and task-dependent)</p>
--

5.3.3.3 0g Effects

5.3.3.3.1 Transition from 1g to 0g

Upon orbital insertion, the sudden disappearance of certain vestibular signals can contribute to SD during head movements, as head tilts no longer generate otolith responses, leading to strong visual-vestibular sensory conflict (as well as inadequate gaze stabilization – see below). In addition, because there is no “downward” pull from gravity, the usual tactile and proprioceptive cues are not available to replace missing vestibular cues; e.g., there is no sensation on the bottoms of one’s feet to indicate standing “up,” and no seat-of-the-pants cues to indicate sitting “down.” Especially during the first day or so of a mission, SD increases the overall potential for SMS and human error in doing onboard tasks. SD has also occurred during EVA, partly due to an unexpected location of the Earth or Sun in relation to the vehicle. Some EVA crewmembers also experience the sensation of falling that in some cases can be quite disturbing (Linenger, 2000). Without the visual cues provided by the inside of the vehicle, the unloading of the otoliths is interpreted as falling. This sensation is less prominent while crewmembers are located in the concave Shuttle payload bay.

Orientation discrimination and motion perception are significantly better along the cardinal axes than along oblique axes (Howard & Templeton, 1966; Krukowski et al., 2003). Faces and printed text are difficult to recognize when tilted by more than about 60° (Corballis et al., 1978). Unfamiliar relative orientations occur often in 0g, where both the crewmember and objects in the environment have six degrees of freedom of movement, allowing an infinite number of positional relationships to occur between them. Since astronauts spend great amounts of time in 1g-oriented trainers, their mental spatial maps are likely deeply encoded for a single orientation. Unless crewmembers become adept at mentally rotating themselves and/or their environment to a more familiar relative orientation and/or develop a wider array of internal spatial maps, they may become temporarily disoriented when confronted with the abnormal perspectives they experience while in the vehicle under 0g conditions. In 0g, especially early in missions, crewmembers prefer orientations that are similar to those encountered in 1g.

Susceptibility to visual illusions increases with age because a reduction in the efficacy of vestibular function increases visual dependence (Howard & Jenkin, 2000).

Spatial navigation also can be compromised. Astronauts on the Russian *Mir* space station and the ISS have on occasion lost situational awareness, which would be problematic should an emergency egress be necessary.

5.3.3.3.2 Transition from 0g to 1g or Partial-g

Upon gravitational reloading, the adaptive perceptual and oculomotor changes that had occurred in response to 0g suddenly become maladaptive. In particular, on Earth, otolith signals are associated with both head tilts and translation, while in 0g, they are associated exclusively with translation. Postflight illusions of self-motion are consistent with the theory of otolith tilt-translation reinterpretation (OTTR: Parker et al., 1985; Reschke & Parker, 1987; Young, 2000), which holds that in 0g the brain learns to interpret otolith signals as indicators of translation (and not tilt), so that postflight head tilts can be misperceived as translation or tumbling, leading to both SD and SMS. These transient postflight visual-vestibular disturbances can be associated with a significant decrement in sensorimotor performance, making actual Shuttle landings, on average, half as precise as preflight landings in trainers (Paloski et al., 2008).

Again, spatial navigation can be compromised. For example, in some cases, lunar module pilots became momentarily disoriented with respect to lunar surface reference points during some Apollo lunar landings (Paloski et al., 2008). Such navigational SD could also be dangerous during an emergency in which astronauts must find their way out of the spacecraft quickly.

Postflight changes in locomotor control and segmental coordination include disruption in spatial orientation during overground walking (Glasauer et al., 1995), alterations in muscle activation variability (Layne et al., 1997; Layne et al., 2004), modified lower limb kinematics (McDonald, et al., 1996; Bloomberg and Mulavara, 2003; Miller et al., 2010), alterations in head-trunk coordination (Bloomberg et al., 1997; Bloomberg and Mulavara, 2003), reduced visual acuity during walking (Peters et al., 2011) and decrements in the ability to coordinate effective landing strategies during a jump down task (Newman et al., 1997; Courtine and Pozzo, 2004). A postflight assessment of functional mobility after long-duration spaceflight (6 months) using an obstacle course showed that adaptation to spaceflight led to a 48% increase in time to complete the course 1 day after landing. Recovery to preflight scores took an average of 2 weeks after landing (Mulavara et al., 2010). Extensive use has been made of dynamic posturography to investigate alterations in postflight postural equilibrium control (Black et al., 1995; 1999; Paloski et al., 1992; 1993; 1994; Wood et al., 2011). The most substantial postflight changes in postural stability measured by these tests occurred when the subject was forced to rely primarily on vestibular feedback; i.e., the visual and proprioceptive feedback was altered and/or absent (Paloski et al., 1999).

5.3.3.4 0g Countermeasures

Defining a Local Vertical – In 0g there is no “up” or “down” in terms of gravity, and defining a local vertical direction in another way can minimize SD. Defining vehicle surfaces as ceilings, floors, and walls, and maintaining consistency throughout the vehicle provides familiar visual cues to help maintain orientation (see section 8.3.2, “Orientation”).

Preflight Adaptation Training – Most 1g trainers allow only one orientation at a time, and require reconfiguration to different orientations. Preflight training using computer simulations of a spacecraft, especially with a full field of view, can provide exposure to any spacecraft orientation in real time and may “preadapt” astronauts before the mission to the multiple orientations they will experience in 0g (Stroud et al., 2005). If they have a motion base, such trainers could be used to expose and potentially preadapt crewmembers to some of the abnormal visual-vestibular correlations experienced in 0g. If crewmembers could learn multiple adaptation states before flight for rapid recall during flight (Welch et al., 1998), then adaptation time could be minimized along with vulnerability to SD.

Sensorimotor Adaptability Training – The human brain is highly adaptable, enabling individuals to modify their behavior to match the prevailing environment. Subjects participating in specially designed training programs can enhance their ability to rapidly adapt to novel sensory situations. By applying these concepts for training astronauts, we can enhance their ability to “learn how to learn” by adapting when transitioning to new gravitational environments. A sensorimotor adaptability training program that exposes crewmembers to variations in sensory input and to balance challenges with repeated adaptive transitions among states can be used to enhance the ability to learn how to assemble and reassemble appropriate motor patterns in novel sensory environments (Seidler, 2004, 2010; Mulavara et al., 2009; Batson et al., 2011).

5.3.4 Oculomotor Control and Active Vision

Both voluntary and reflexive eye movements are adversely affected by altered gravity, which acts to disrupt gaze stabilization and ocular tracking, and therefore reduces dynamic visual acuity (Reschke et al., 1999). More specifically, the components of the VOR that use otolith signals become inaccurate under g-loading or g-unloading, and smooth ocular tracking, especially coordinated head-eye tracking, is compromised under 0g. High-frequency variations in g-loading (i.e., vibration) will exacerbate these visual deficits.

5.3.4.1 Acceleration and Hypergravity Effects

Sustained transverse-axis g loading has a number of significant impacts on human visuomotor performance:

- *Impaired accommodation and decreased visual acuity.* This effect is due to mechanical effects on the optics of the eye and to tearing (worse for $-G_x$ loads). Chambers (1961) reported difficulty focusing at levels as low as $+3G_x$. White and Jorve (1956) found that a target needed to be twice as large to be seen at $+7G_x$.
- *Decreased contrast sensitivity.* Acceleration forces produce an effective dimming of visual stimuli, presumably because of reduced blood flow in the retina. Chambers and Hitchcock (1963) describe a 50% increase in the contrast needed to make threshold discriminations at $+5G_x$. This effect decreases at high display luminance levels.
- *Decreased field of view.* Little quantitative information exists about the effect of transverse acceleration. Chambers (1961) found some loss of peripheral visual field at $+6G_x$, which increased dramatically above $+12G_x$. For positive acceleration ($+G_z$), the between-subject variability is about 30% (Zarriello et al., 1958). If a similar between-subject variability exists for transverse accelerations, this would suggest that some may experience at least some decrement in peripheral vision at g-loads as low as $+4G_x$.
- *Increased reaction time.* Reaction time to both visual and auditory stimuli is increased during exposure to hypergravity (Canfield et al., 1949), although isolating sensory latency effects from cognitive effects and motor output delays is problematic. In a visual spatial response task described by Chambers and Hitchcock (1962; 1963), reaction times were elevated at $+6G_x$ and some responses in mission-related tasks were elevated by more than a second. Although auditory responses are also subject to reaction-time increases, audition seems to be more robust to hypergravity than vision (i.e., audition can persist at g-levels above those that cause visual grayout or blackout).

5.3.4.2 0g Effects

5.3.4.2.1 Transition from 1g to 0g

Upon orbital insertion, all otolith contributions to tilt-compensating reflexes will disappear; thus, compensatory gains must at least be transiently decreased. The pitch and roll AVORs (which on Earth represent combined rotations and tilts with respect to gravity) show reduced gain; the OCR response will

be abolished, but there is no reason to expect the yaw AVOR to change, as it functions essentially independently of the otoliths. Therefore, pitch and roll head movements will generate larger than normal retinal slip and visual-vestibular mismatch (associated with an increased probability of SMS; Lackner & Graybiel, 1985), while yaw head movements should produce little or no degradation of vision. These findings have been borne out to a large degree by space flight studies of both humans and monkeys (Reschke et al., 1999; Clement & Reschke, 2008). Yaw head oscillations revealed little evidence of any systematic gain change during flight in humans or monkeys. However, human pitch VOR seems to be initially reduced during flight compared to upright preflight controls (Vieville et al., 1986). The roll VOR torsional response is also reduced during flight (STS-42 REF) and, as expected, the OCR disappears entirely during flight (Reschke et al., 1991).

An initially reduced pitch VOR gain seems to increase over time during flight (Vieville et al., 1986). Dynamic roll stimuli generate a large horizontal response in flight (STS-42 REF), consistent with the view that otolith signals generated during dynamic roll may be to some extent reinterpreted as IA translation.

In addition to its impact on the VOR, 0g also has an adverse impact on voluntary smooth tracking eye movements (pursuit), with the gain reduction (and associated increase in catch-up saccades) becoming more severe during combined head and eye tracking, particularly along the vertical axis (Andre-Deshays et al., 1993; Reschke et al., 1999; Moore et al., 2005). Furthermore, errors in acquiring information from instrumentation and in tasks requiring eye-head-hand coordination become more common (Reschke et al., 1999).

5.3.4.2.2 Return from 0g to 1g or partial-g

During combined head-eye active pursuit, the postflight pitch VOR gain seems to be greater than 1 (Reschke et al., 1999). Studies in both humans and monkeys generally showed a significant reduction of OCRs postflight as compared to pre-flight controls, and this reduction can last for many days (Arott & Young, 1986; Dai et al., 1994; Young & Sinha, 1998). Postflight responses to IA stimulation gave evidence for decreased torsional responses (Arott & Young, 1986; Dai et al., 1994; Clarke, 2006) and increased yaw responses (Parker et al., 1986), consistent with the OTTR hypothesis.

Thus, upon entry and landing, vision can be compromised, particularly during vertical head movements:

- *Target acquisition.* When targets (e.g., instruments) are outside of the effective oculomotor range, acquisition of the target is accomplished with both a head movement and eye movement. Acquisition of targets can be delayed by more than 1 second.
- *Pursuit tracking.* Visual pursuit of a moving target and reading can be difficult. Use of the Ball-Bar (visual ground-based final approach aid for runway landings) as a landing aid can be compromised because of space flight-induced errors in pursuit tracking.

These changes in head-eye coordination can lead to decrements in postflight visual acuity during head movements (Peters et al., 2011).

5.3.4.3 Vibration Effects

Display Vibration – Vibration-induced lateral image motion smaller than ± 1 arcmin (about ± 0.5 point at a 24-inch viewing distance) is below human visual resolving capability (Howard, 1982). Larger

amplitude vertical or horizontal image motion with low-frequency content (up to about 1 Hz) can effectively be tracked by the pursuit system, enabling slowly oscillating displays to be read when the observer is not moving, although these conditions will increase workload and the risk of motion sickness. Higher frequency oscillations ($> \sim 2\text{-}5$ Hz) above $\sim 0.2^\circ$ will cause blurring of the retinal image, negatively affecting legibility at standard font sizes, and increasing reading time, reading errors, and reading difficulty (O'Hanlon & Griffin, 1971).

Observer Vibration – When crewmembers are subjected to vibration, their VOR is able to stabilize images on the retina almost perfectly, compensating for head yaw rotation for frequencies up to about 12 Hz (Ramachandran & Lisberger, 2005). Despite the VOR, at $+0.5G_z$ root mean square (RMS), there is about a threefold decrease in acuity for short viewing distances (15.5 in., which is similar to that anticipated on Orion) in the range of 5 to 20 Hz (O'Briant & Ohlbaum, 1970), suggesting that VOR compensation for head translation may be less effective above 5 Hz. The eye itself, depending on seating posture and head support, demonstrates mechanical resonance with respect to the head beginning at 20 to 70 Hz (Griffin, 1990), which will act to exacerbate blurring of the retinal image. However, at these extremely high frequencies, staying below the health and safety limit will necessarily keep vibration amplitudes low and thus minimize interference with visual function. The vulnerable range is therefore 2 to 30 Hz, which includes the expected solid rocket booster thrust oscillation vibration peak near 12 Hz during launch.

These vibration effects have implications during flight regimes such as launch, orbital engine burns, and atmospheric entry.

5.3.4.4 Oculomotor Control Countermeasures

Robust Display Design – To mitigate the impacts of vibration, g-loading, and unloading on visuomotor performance, the following generic design guidelines should be applied to any display system to be used for flight control or system monitoring by the crew during altered-g and/or high-vibration phases of the mission. These guidelines should complement the “Displays” section recommendations as they are specific to displays that will be used to support tasks under conditions where sustained acceleration exceeds $3G_x$ or $2G_z$ (TBR), or vibration exceeds 0.15g zero-to-peak in any direction (TBR).

- Visual displays should be centrally positioned, bright (> 3 ft-lamberts TBR), have high contrast ($> 30\%$ TBR), and minimize demands on accommodation (viewing distance > 49 cm TBR) as well as acuity (any symbology or text should subtend at least 0.4° of visual angle, i.e., 10-pt font at 19 inches, TBR).
- Given that auditory signals seem more resistant to g-loading, the use of auditory caution and warning tones would seem particularly well suited for conveying critical information requiring a rapid response under high-g off-nominal conditions.

Conservative Operational Concept – Tasks should minimize the need for head movements with pitch, roll, or translation components (i.e., tasks should not require peripheral viewing or acquisition) during or immediately after g-transitions, especially during a transition back to a gravity-loaded condition after extended ($> 2\text{-}3$ days) adaptation to $0g$.

Periodic Centrifugation (Artificial Gravity) – During the Neurolab mission, a pre-, in-, and postflight study (Moore et al., 2003) of g forces applied along the IA axis by G_y centrifugation during flight yielded both a largely normal OCR response (i.e., normal torsional eye movements, not OTTR reinterpreted yaw eye movements) and a largely normal somatogravic illusion (i.e., appropriate perceptions of tilt, not of translation). Unlike the findings in most previous studies (see above), in the Neurolab study, the postflight OCR was found to be normal. The conflict between these recent results and earlier findings suggest that that periodic g loading of 0.5g or 1.0g may provide protection against oculomotor and perceptual adaptation.

5.3.5 Hand-Eye Coordination

5.3.5.1 Acceleration and Hypergravity Effects

Reaching – Humans can perform reaching movements at levels at least up to $+6G_x$, but reaches are on average ~ 50 ms slower than at $1G_z$ (Kaehler & Meehan, 1960). Even when veteran astronauts and aviators were used as subjects, suited subjects on average exhibited a 6% reduction in forward reach displacement at 3g (18% at 4g, 32% at 5g), with 40% of subjects declining to be exposed to loads over 4g (Schafer & Bagian, 1993). Thus, at and above 3g, even with highly motivated and trained subjects, the accuracy of gross limb movements is compromised, with “fatigue and suit interference” being significant concerns. Above 2g, reaching may begin to show direction errors; propagating a 6% displacement error into the forward component of oblique reaches predicts a closed-loop direction error of about 2° (approximately a toggle-switch or edge-key width) for oblique reaches directed more than 33° away from straight ahead. Note, however, that this crude calculation underestimates open-loop errors that will affect reaches under severe time constraints (e.g., critical reaches during off-nominal conditions) or reaches made by deconditioned crewmembers.

Manual Control – Under certain conditions, humans can remain conscious for many seconds and actuate a side-arm controller using hand-wrist-thumb movements at peak levels exceeding $+20G_x$ (Collins et al., 1958) and can even perform meaningful flight-control operations at $+15G_x$ (Chambers, 1961; Chambers & Hitchcock, 1963), although vertigo for up to 48 hours has been reported after exposure to $+15G_x$ for 5 seconds (Duane et al., 1953). However, even at the moderate levels of transverse g-force exposure ($+3G_x$ to $+6G_x$) expected during a nominal ascent and even with side-controller interfaces, there is reason to anticipate some compromising of performance in the form of increased reaction times, decreased accuracy, and increased time-to-completion of manual reaching and control tasks. These concerns nonetheless can be mitigated or overcome; the successful Mercury, Gemini, and Apollo programs are a historic testament to that fact.

Chambers (1961) and Chambers and Hitchcock (1962, 1963) examined tracking and flight-control performance under Mercury-like conditions with a number of candidate multi-axis hand-wrist side controllers under a range of transverse g-loads. At $+6G_x$, they found a small but objective decrement in performance for all candidate controllers that averaged $\sim 25\%$ compared to 1g. The magnitude of the decrement was dramatically different for the various candidate controllers, with some becoming completely inadequate at $+6G_x$. For example, a threefold difference across the five controllers occurred in the graphed data for the total integrated roll error. Interestingly, the subjective self-assessment of performance did not seem to correlate well with the objective performance data. The take-home message from these investigations is that, although many two- to four-axis side controllers (and associated toe pedals) can support adequate performance above $+4G_x$, the specific controller design matters greatly.

Under Apollo-like conditions, pilots who were asked to maintain a constant g level during entry simulations of essentially a 1-dimensional roll control task showed no effect of G_x loading at 3g in either pilot subjective workload ratings or in objective measures of control error (Wingrove et al., 1964). At and above 4g, G_x loading had increasing adverse effects, with about a ½-point increase in the Cooper-Harper rating and about a 25% increase in control error at 6g, such that pilots generated oscillations that could exceed $\pm 0.5g$ at about 0.03 Hz during +6 G_x runs. Similarly, subjective and objective performance in a 3D flight control task deteriorated markedly at levels greater than 4g when pilots were controlling a lightly damped spacecraft, such that “an increase in spacecraft dynamic stability was required with increases in the magnitude of the acceleration” (Creer et al., 1960). Furthermore, in a subjective comparison of controller interfaces, there was a unanimous preference for two-axis hand controllers for pitch and roll control combined with a toe pedal for yaw control, as this configuration (and not the three-axis side controller) was fully satisfactory under well-damped, moderately cross-coupled conditions, as well as acceptable under lightly damped and heavily cross-coupled conditions.

5.3.5.2 0g Effects

5.3.5.2.1 Transition from 1g to 0g

Reaching – Because of the sudden off-loading of the arm, rapid reaches will initially tend to be high, but this will likely adapt quickly, given visual and proprioceptive feedback (Cohen, 1970; Cohen & Welch, 1992).

Manual Control – One would not anticipate any significant impact on manual control as long as the arm is properly stabilized and supported.

5.3.5.2.2 Return from 0g to 1g

Reaching – Because of the sudden reloading of the arm, rapid reaches will initially tend to be low and require increased effort, but the crew will likely readapt quickly with visual and proprioceptive feedback (Cohen, 1970; Cohen & Welch, 1992).

Manual Control – Although one would not anticipate any specific impact on manual control as long as the arm is properly stabilized and supported, manual control will be vulnerable to any SD and gaze instability experienced on the reloading of a space-adapted vestibular system (see 5.2.3.3 above). More specifically, illusions of self-translation induced by head movements may adversely influence control inputs during entry. For Space Shuttle landings, there is a correlation between landing quality and postflight clinical vestibular assessment (McCluskey et al., 2001).

5.3.5.3 Vibration Effects

Vibration has adverse consequences on human hand-eye coordination, largely because of its effects on gaze stabilization and vision (see section 6.7, “Vibration,” and 5.4.12.2 above) but also because of its direct impact on motor control. Specifically, proper limb restraint or support is critical for enabling reliable performance and minimizing inadvertent control inputs. Furthermore, because of changes in biomechanical impedance, the impact of vibration interacts nonlinearly (i.e., unpredictably) with g loading. At +3.5 G_x , vibration levels exceeding 0.14g RMS begin to adversely affect performance

(Vyukal & Dolkas, 1966). Above 0.3g RMS, only coarse actions (e.g., switch activation not under visual control) are reliable, and above 0.5g RMS manual control is severely degraded, with potentially safety-compromising after-effects lasting minutes after the exposure.

5.3.5.4 Hand-Eye Coordination Countermeasures

Robust Controller Design – To mitigate the impacts of g-loading and unloading on hand-eye coordination, the following generic design guidelines should be applied to any interface to be used for flight control or system monitoring by the crew during high-g or high-vibration phases of the mission. These nominal guidelines should complement the “Controls” section recommendations (see section 10.4, “Controls” as they are specific to controls that will be used to support tasks under conditions where sustained acceleration exceeds $3G_x$ or $2G_z$ (TBR) or vibration exceeds 0.15g zero-to peak in any direction (TBR).

- Hand-wrist-finger actuators or toe pedals should be used for all crew operations. Although safe and effective reaches are possible from $2G_x$ to $3G_x$, the target display edge keys or switches should be positioned within a central 30° cone to minimize errors and effort.
- For manual control at or above $3G_x$ or $2G_z$, the dimensionality and difficulty of the control task should be minimized, and automated stability augmentation should be provided.
- Proper limb support and/or restraint must be provided to support accurate control and minimize inadvertent inputs.

Robust Operational Concepts – Reaches should be confined to a central 30° region for sustained acceleration levels above 2g and should not be used for nominal tasks during sustained g loading above 2g. At vibration levels above 0.5g zero-to-peak (TBR), only simple non-visual binary motor tasks (e.g., button pushes) should be planned.

Periodic Centrifugation (Artificial Gravity) – Periodic g loading of 0.5g or 1.0g seems to protect against oculomotor and perceptual adaptation (Moore et al., 2003); thus, it may also protect against long-term adaptation of hand-eye coordination to 0g, with respect to both neurovestibular and musculoskeletal functioning.

5.3.6 Balance and Locomotion

5.3.6.1 Postflight Effects

Vestibular and tactile responses as well as muscle strength and reflexes are affected by 0g and, on return to Earth, these effects can lead to problems with balance and locomotion, which are made worse by cardiovascular deconditioning (see section 5.2.4.1) and gaze stabilization problems (see section 5.3.4 above and Bloomberg and Mulavara, 2003). After long-duration flight these changes can persist for many days. Changes in balance and locomotor control have implications for the design of ladders and steps used to egress landing vehicles, and for the distance required to walk from a landing spacecraft to a habitation module or safe area.

Neural Adaptation – Just like the vestibuloocular reflexes, the vestibulospinal reflexes (see section 5.3.2 above), which are critical for making rapid automatic postural adjustments during locomotion on Earth, also adapt to weightlessness (Paloski, 1998). Thus, on return to Earth, astronauts experience varying

degrees of ataxia, postural instability, and locomotor dysfunction, especially under impoverished visual conditions (Paloski & Reschke, 1999; Bloomberg et al., 1999).

Muscular Deconditioning – Astronauts can lose up to 20% of their muscle mass on short-duration missions, and as much as 50% on long-duration missions, primarily in the postural muscles of the legs and back, if countermeasures are not used (Clement, 2003). After landing, this can affect both balance and locomotion, which are important for safe and rapid spacecraft egress. It has been observed that astronauts who have been on flight missions for less than 20 days require from 2 to 4 days to recover to their preflight balance performance, whereas crewmembers on longer, multi-month missions, such as those on the ISS and *Mir*, have taken 15 days to recover functional mobility to within 95% of preflight levels (Mulavara et al., 2010).

5.3.6.2 Countermeasures for Sensorimotor Function

Countermeasure strategies include preflight training to facilitate transition to microgravity, pharmaceuticals and restriction of some activities early on orbit, and inflight exercise to minimize deconditioning during longer-duration missions. Active motion is important to promote reconditioning upon return to Earth's gravity. A supervised reconditioning program uses exercises that challenge multisensory integration with an increasing level of difficulty customized to the individual's state of recovery (Wood et al., 2011). This program also serves to increase crew self-awareness of fall risk. New resistive and aerobic exercise capabilities onboard the ISS contribute to improved postflight mobility.

To maintain the sensorimotor functions, use of a treadmill device has been found to aid with adjustment back to a 1g environment after a 6-month ISS mission.

5.3.7 Research Needs

The following gaps in our critical knowledge about the impact of space flight have been identified:

- *Effects of g-loading and vibration in isolation and in combination on visual performance, gaze stabilization, and manual control*
- *Computational modeling of human performance limits in aerospace visuomotor tasks related to gaze stabilization, visual function, cognitive processing, and motor control in support of optimal space flight interface design*

An extensive discussion of these gaps can be found in Paloski et al. (2008).

5.4 VISUAL PERCEPTION

5.4.1 Introduction

The visual sense is our primary means of collecting information from the world around us: both information that is formatted for us by other humans and information that resides in the objects, events, and environments that surround us. Astronauts rely on the visual sense to perform every aspect of their missions, including reading text, scanning instruments, observing their environment, executing tasks, and communicating with other crewmembers. It is therefore appropriate to construct human factors standards that take into account the capacities and limitations of the human visual sense. Those standards are likely to apply to visual displays and communication systems, to visual aids such as visors and viewing aids, as well as to the design of tasks that involve vision.

The purpose of this section is to provide a brief compendium of the key attributes of human visual sensitivity. In addition, where possible, these capacities will be related to the unique conditions or demands of human space flight. This section serves in part as a point of reference for other chapters in this handbook, such as “Visual Displays” and “Lighting,” that address visual issues.

In the interests of brevity, only the most fundamental and well-established facts about human vision are dealt with here. The section is also restricted largely to functional aspects of the visual process, rather than the optical, physiological, anatomical, or neurological substrates.

5.4.2 The Eye and Visual Brain

Vision begins with light entering the eye, where it is shaped by the visual optics into an image on the retina, a tissue covering the back of the eye and composed of layers of photoreceptors and associated visual neurons. The photoreceptors are either rods, which are responsible for vision at low light levels (scotopic vision), or cones, which respond at higher light levels (photopic vision). There is a significant luminance range (mesopic vision) in which both rods and cones are active (see Figure 5.4-4). The different wavelength selectivities of the three types of cone underlie our perception of color.

Light is absorbed by photopigments in the photoreceptors, converted to electrical signals, and conveyed via various intermediary neurons to the optic nerve and thence to the lateral geniculate nucleus, and onward to the visual cortex. The visual cortex consists of numerous distinct areas, all located toward the rear of the brain, that seem to be specialized for various visual processing tasks. Together these areas contain several billion neurons and comprise a substantial fraction of the entire brain.

5.4.3 The Visual Stimulus

There is no unique or best way to characterize the stimulus for vision. It ultimately consists of the shower of photons falling on the two eyes, but this may be characterized in terms of reflective objects and illuminants, or wavefronts, or retinal images, depending on the purpose of the characterization. Here the perspective is drawn from the laboratory study of vision and is suited to description of flat imaging displays. The stimulus is considered to be a distribution of radiant intensity (I , radiance) in the direction of the eye over time (t), wavelength (λ) and two dimensions (x, y) of space, and a final dimension of eye (e , left or right). This can be written as a function: $I(x, y, t, \lambda, e)$.

The two dimensions of space, x and y , are conceived as the horizontal and vertical dimensions of an image, and their dimensions are measured in degrees of visual angle. Visual angle is the angle subtended by an object or image element at a specific distance from the eye. A standard formula for the angle

subtended by an object of height H viewed on a surface orthogonal to the line of sight from distance D to the center of the object is

$$\alpha = 2 \tan^{-1} \frac{H}{2D} \quad (1)$$

Visual angle is usually reported in degrees (deg), minutes (arcmin, $60 \text{ arcmin} = 1^\circ$), or seconds (arcsec, $60 \text{ arcsec} = 1 \text{ arcmin}$), or in radians (rad, $2 \pi \text{ rad} = 360 \text{ deg}$) or milliradians (mrad, $1000 \text{ mrad} = 1 \text{ rad}$). As an example, from Earth, the Moon subtends a visual angle of about 36 arcmin. The small angle approximation to equation (1) is

$$\alpha = K H/D \quad (1a)$$

K is 1 for radians, 1000 for mrad, $180/\pi$ for deg, $60*180/\pi$ for arcmin, and $3600*180/\pi$ for arcsec. If the above example had been computed with (1) and was recomputed with (1a), the result would be 36.0003 arcmin. The result for 10 deg is 10.026.

In the following sections, each of these dimensions of space, time, and wavelength is examined in turn. The above stimulus expression is often abbreviated. For example, in the discussion of spatial sensitivity, it is common to consider a luminance image, in which time, wavelength, and eye distributions are constant and are omitted, yielding an expression $L(x,y)$. The luminance image itself is often usefully converted into a contrast image, by subtracting and then dividing by a mean adapting luminance, L_0 ,

$$C(x,y) = \frac{L(x,y) - L_0}{L_0} \quad (2)$$

In this way, the image is converted into signed fractional differences from the mean. In the section on Light Adaptation below, this representation is a better description of the visual intensity of the image.

5.4.4 Thresholds and Sensitivity

In the following description of human vision, the primary concern is with the limits of vision: distinguishing between things that can be seen and those that cannot be seen. These limits will be specified in terms of the dimensions introduced above: primarily space, time, and wavelength. The boundary between visible and invisible is sometimes described as a Window of Visibility, through which we see the world (Watson et al., 1986). To define this boundary, the concept of the visual threshold is needed. Consider a visual target, for example a circular disk 1° in diameter with a duration of 100 milliseconds (ms) and some specified contrast on a steady uniform background. At a very low contrast, the target will be invisible; at a high contrast, it will be highly visible. Between those two extremes is a contrast at which the target is just visible, and this is called the contrast threshold. In practice, the threshold is determined in an experiment in which the target is presented many times at various contrasts, and a psychometric function (or “frequency of seeing curve”) is constructed that describes the probability of a correct detection as a function of target contrast. This is illustrated in Figure 5.4-1. The psychometric function separates the visible from the invisible, but because of variability in human judgments, this transition is not abrupt but gradual. To specify the location of this transition with a single number, the contrast T at which this curve reaches a specified probability (in this case $P = 0.632$), is defined as the threshold. Thus, in the example, if the target were detected 63% of the time at a contrast of 0.2, then the threshold would be $T = 0.2$. Further details on rationale and methods of threshold measurement are available (Farell & Pelli, 1999; Sekuler & Blake, 2006).

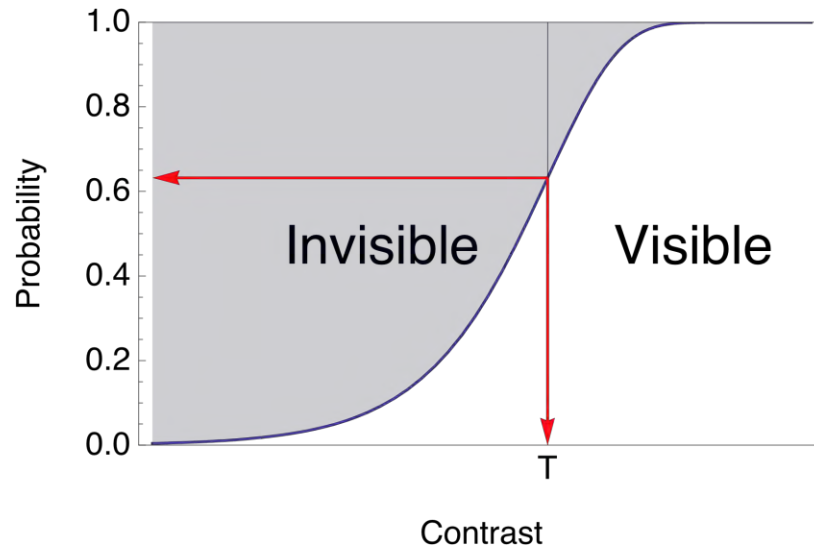


Figure 5.4-1. Threshold and the psychometric function.

Since T is the smallest amount of contrast that can be seen, it is also called the Just Noticeable Difference, or JND. Multiples of this quantity are said to be in units of JND. The inverse of the threshold, $S = 1/T$, is defined as the contrast sensitivity. A large contrast threshold corresponds to a small sensitivity, and vice versa.

In the remainder of this section, how threshold varies as a function of one dimension of the stimulus will often be considered. This is a useful and informative approach, but it should always be understood that the threshold is a consequence of all of the dimensions and attributes of the target. Thus threshold may be measured as a function of the size of the target, while keeping the duration fixed. But the results may differ if a new fixed duration is used. One challenge for modern vision science has been to integrate results from the various dimensions, and their interactions, into a general model of visual sensitivity.

The example of contrast threshold has been used here, but the same principles can be used to measure thresholds for other dimensions.

Since visual thresholds lie at the extremes of our visual experience, and since most of our productive visual experience occurs well above threshold, it could be asked, “Why study or care about thresholds?” One answer is that thresholds have proven extraordinarily valuable in uncovering the mechanisms of visual perception. Nearly all of what is known about human vision was at least initially discovered by this means, though much has been confirmed and elaborated by physiological methods.

But the more relevant answer here is that visual performance is remarkably uniform above threshold. In many aspects of visual performance, performance rises rapidly just above threshold, but then quickly reaches a plateau beyond which improvements are small or nonexistent. To take one example, reading rate increases rapidly as size or contrast just exceeds threshold, but then it remains constant at suprathreshold levels (Legge et al., 1987). Once again, the Window of Visibility provides a useful metaphor: outside the margins of the window, nothing can be seen, but within, all is about equally visible. Thus, from a performance point of view, it is important to use thresholds to demarcate the boundaries of this window.

5.4.5 Visual Optics

The optics of the eye impose the first limit on human visual performance. Understanding the optical status of the crewmember, and how that status is altered by age, lighting conditions, or long-duration

missions, is critical to design of visual displays and interfaces and to planning of visual tasks. As one example, recommendations for font size usually assume good optical focus; poor focus due to lack of accommodation or aberrations will require increased font size.

The optical components of the eye that are of greatest functional significance are the cornea, the lens, and the pupil. The cornea, the outermost optical element, is responsible for the bulk of the focusing power (about 40 diopters), while the lens performs a fine-tuning through a range of about 20 ± 8 diopters. The focus adjustment by the lens is known as accommodation. The ability to accommodate declines with age, and is essentially absent beyond the age of 50.

5.4.5.1 Refractive Errors

In a so-called emmetropic observer, an object at infinity is in focus on the retina; otherwise, refractive errors are said to exist. These are divided into myopia (focus in front of the retina), hyperopia (focus behind the retina), and astigmatism (different focus at different orientations). All of these spherical and cylindrical errors can be corrected with spectacle lenses.

5.4.5.2 Wavefront Aberrations

Perfect vision, in an optical sense, consists of a light wavefront that is an appropriate spherical surface as it enters the pupil. In recent years, it has become common to represent the optical state of an eye in terms of its wavefront aberration function, defined over the pupil area, describing the departure of the optical wavefront from the appropriate spherical surface. This function is usually represented by a set of mathematical functions known as Zernike polynomials (Thibos et al., 2002). In this formulation, defocus and astigmatism, which yield the refractive errors described above, are low-order aberrations; other more complex optical defects are high-order aberrations. High-order aberrations cannot be corrected with spectacles, though efforts to do so with refractive surgery and contact lenses are ongoing. With the Zernike formulation, one can mathematically describe an eye with specified defects, such as defocus, astigmatism, and higher-order aberrations, and can predict the image that would be formed on the retina by an object in view. Recently models have shown how letter acuity can be predicted from arbitrary wavefront aberrations (Watson & Ahumada, 2008).

Because image formation is a linear process, the wavefront aberration function can also be converted into a point-spread function or an optical transfer function, either of which can be used to render a retinal image from an object image. In a later section, we will discuss how the optical transfer function contributes to the overall contrast sensitivity function of the human observer.

5.4.5.3 Pupillary Reflex

The pupil is the aperture through which light passes, and its diameter, which covaries with ambient illumination through what is called the pupillary reflex, influences both the amount of light admitted and the ultimate degree of focus that can be obtained. Normal pupil diameters range from 2 to 8 millimeters, and are generally smaller in older individuals (Winn et al., 1994). The effects of light level and age on pupil diameter are shown in Figure 5.4-2. The curves in this figure are computed from a formula that includes luminance, area of the adapting field, age of the observer, and whether one or two eyes are adapted (Watson & Yellott, 2012). The figure assumes binocular adaptation and a 20-deg diameter adapting field.

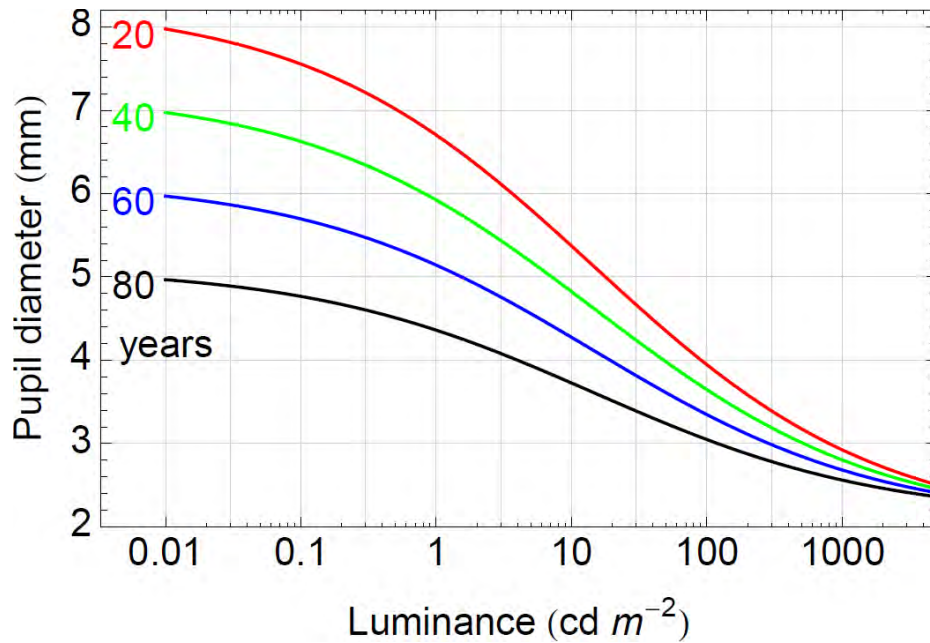


Figure 5.4-2. Pupil diameter as a function of light level and age.

5.4.5.4 Light Scatter

Another optical phenomenon with practical consequences is light scatter. This occurs when light entering the eye is dispersed broadly or uniformly over the retina. Scatter reduces the retinal contrast of targets. Scatter increases with age, and with conditions such as cataracts. Light scatter is responsible for glare, as will be discussed below. Estimates of the fraction of light scattered beyond the conventional point spread range from 0.1 in young eyes to 0.5 in older eyes (Westheimer & Liang, 1995; Ginis, Pérez, Bueno & Artal, 2012).

5.4.6 Sensitivity vs. Wavelength

Sensitivity of the eye to light is confined to a range of wavelengths from about 380 to 780 nanometers. The variations in sensitivity may be measured and depicted in various ways, but here they are defined by the Commission Internationale de l'Éclairage photopic and scotopic luminosity functions, $V(\lambda)$ and $V'(\lambda)$, as shown in Figure 5.4-3. These functions are expressed in normalized form, and show the relative effectiveness of light of various wavelengths. The scotopic function is appropriate for rod vision or dim illumination, and the photopic function is appropriate for cone vision or medium to bright illumination.

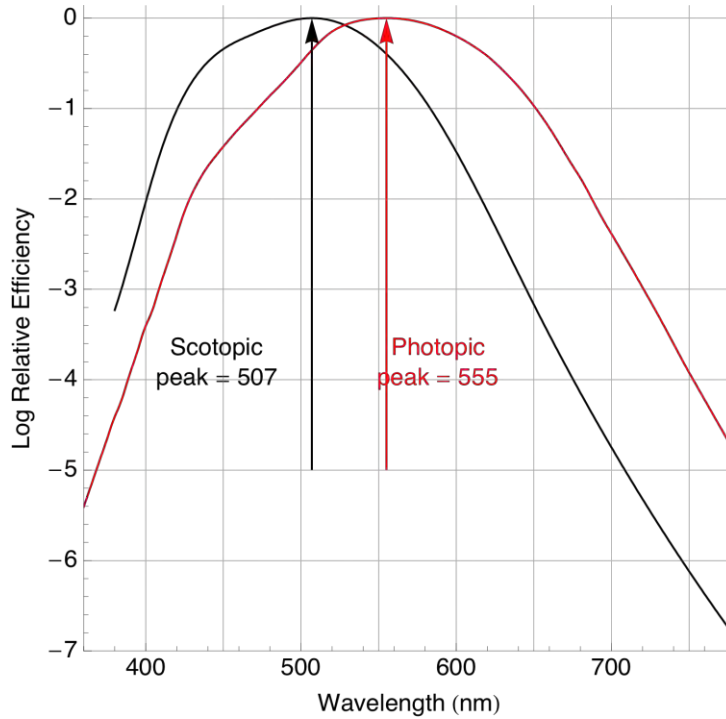


Figure 5.4-3. Photopic and scotopic luminous efficiency functions.

Most light sources are not monochromatic, but rather consist of a distribution of energy over wavelength, which is written here as $I(\lambda)$ and is specified in units of radiance (watts per steradian per square meter, $\text{W}\cdot\text{sr}^{-1}\cdot\text{m}^{-2}$). The effectiveness of such a light in conveying a sense of brightness is determined by the integral of the energy distribution, weighted by the luminosity function. This is formalized in the concept of luminance, defined as

$$L = K_m \int I(\lambda)V(\lambda)d\lambda \quad (3)$$

where K_m is a constant equal to 683 lumens per watt ($\text{lm}\cdot\text{W}^{-1}$), and the integral is taken over the range of visible wavelengths. The Système international d'unités (SI) unit for luminance is candela per square meter ($\text{cd}\cdot\text{m}^{-2}$). Luminance may be distributed over other dimensions, such as space and time, as noted above in discussion of the visual stimulus. A range of other photometric units related to luminance exist, and the reader is referred to a standard reference for further information (Rea, 2000).

Another photometric unit that is widely used in the study of vision is the troland (abbreviated Td). This is a measure of retinal illuminance, and takes into account the amount of light admitted to the eye by the pupil. The trolands (T) for a luminance (L) in $\text{cd}\cdot\text{m}^{-2}$ and a pupil area of P mm^2 is given by

$$T = L P \quad (4)$$

If the pupil diameter is not known, we can convert approximately from luminance to retinal illuminance (and vice versa) using the formula for the pupil diameter described above. Example calculations for four ages for binocular adaptation to a 20-deg diameter field are shown in Figure 5.4-4.

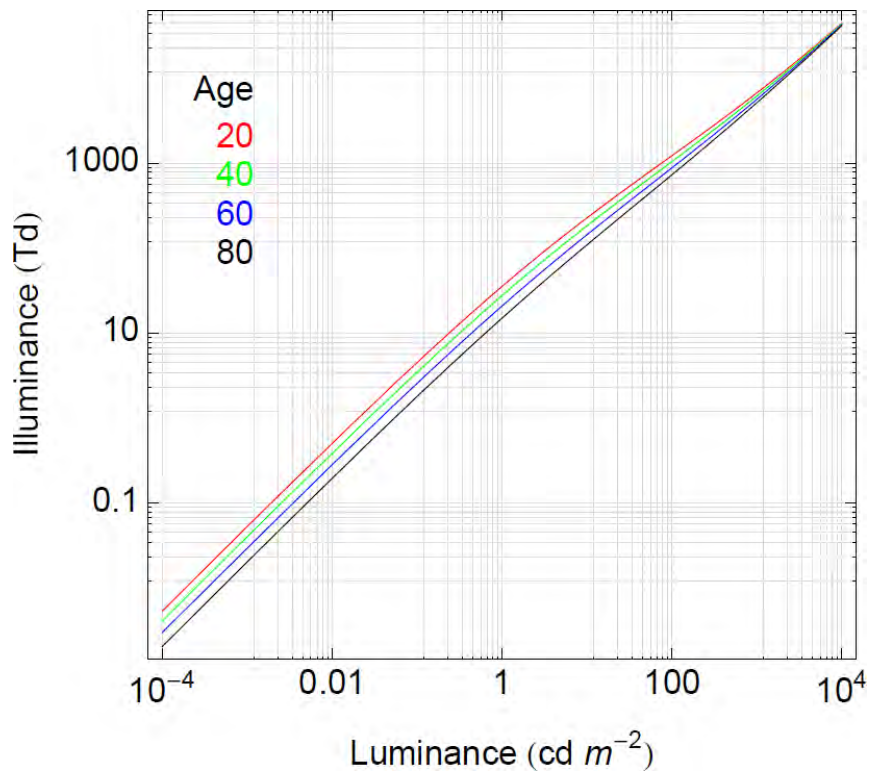


Figure 5.4-4 Relation between luminance and retinal illuminance for 4 ages.

5.4.7 Light Adaptation

The human visual system operates over a range of about 13 log units of light intensity. However, at any one time, it is sensitive to a much smaller range of about 2 log units; light adaptation shifts this window of sensitivity to the prevailing ambient level (Hood & Finkelstein, 1986).

Figure 5.4-5 shows the complete range along with this much smaller sliding window of sensitivity. Values indicate $\log_{10} \text{ cd}\cdot\text{m}^{-2}$. The red box indicates the extent of momentary sensitivity (Hood & Finkelstein, 1986; Kaiser & Ahumada, 2008; Parker & West, 1973)

Sensitivity is governed to a small extent (about a factor of 16) by the pupil, which regulates the total amount of light reaching the retina. The larger effects (around 10^{10}) are accomplished by photopigment and neural reactions. Because these latter effects are local, the eye may be differently adapted in different parts of the visual field.

As a simplification, light adaptation is often divided into so-called steady-state and transient regimes. The steady state refers to an eye that has been allowed to adapt to a temporally and spatially uniform luminance for an appropriate amount of time. Transient adaptation refers to changes in the state of adaptation that follow a change in the adapting luminance. The dynamics of transient adaptation are usually separated into light adaptation—a relatively rapid response to an increase in light—and dark adaptation, a much slower response to a reduction in light. Light adaptation may be essentially complete in several seconds, while complete dark adaptation from a bright adapting level may take as much as 10 minutes (Hood & Finkelstein, 1986).

The sensitivity of the observer is determined by the distribution of light over space and time, which in turn is determined by the luminance of objects in the operating environment, including displays, and the pattern and duration of eye fixations on those objects. Steady-state adaptation is an important factor

affecting display luminance and contrast requirements as well as the effective distribution and coding of gray levels in displayed images. Transient adaptation has important implications for the visibility of information in dynamic and complex illumination environments. Transient visual adaptation can have profound effects on the time course of display visibility and thus on luminance and contrast requirements for displays operated in dynamic viewing environments such as aircraft cockpits (Krantz et al., 1992; Silverstein, 2003; Silverstein & Merrifield, 1985).

To a first approximation, the effect of steady-state light adaptation is to convert luminance into contrast. With increasing light levels, the gain of the visual system is reduced almost in proportion, so that luminance detection thresholds remain a nearly constant fraction of the adapting luminance, that is, a constant luminance contrast. This gain change occurs separately in both rod (scotopic) and cone (photopic) systems. Increasing light levels also yield increases in spatial and temporal resolution, as will be discussed below.

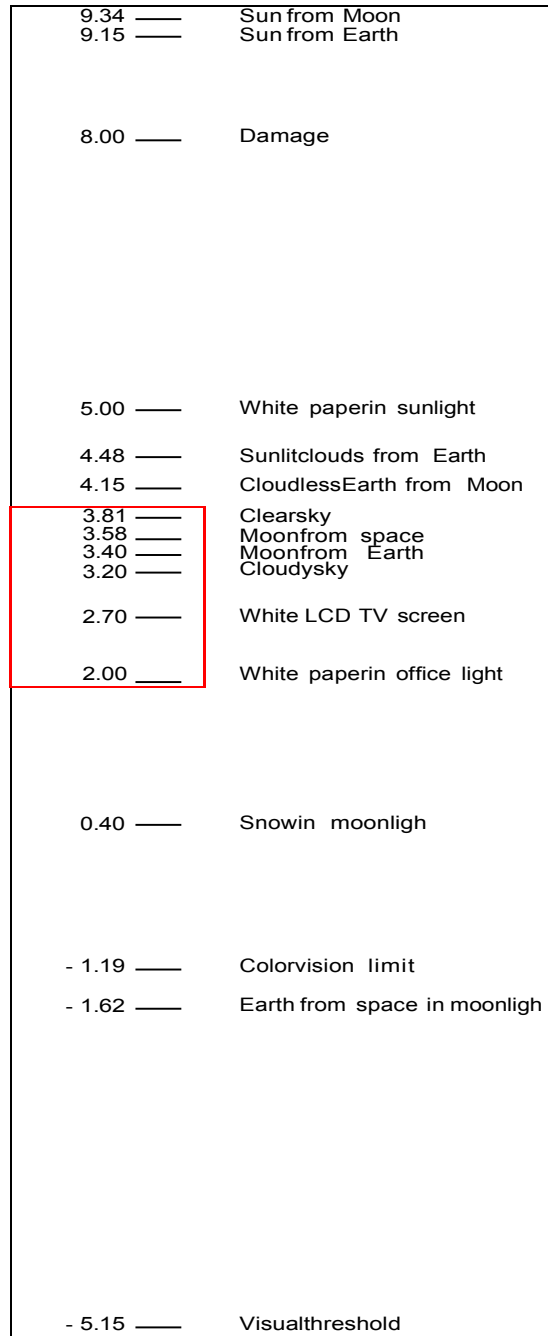


Figure 5.4-5. Luminance range over which human vision operates.

5.4.8 Spatial Sensitivity

Spatial sensitivity describes the ability of an observer to detect or discriminate spatial patterns. Here patterns contained in static monocular luminance images are generally considered. Spatial sensitivity is traditionally characterized in three ways: by spatial summation, by acuity, and by the contrast sensitivity function. From a modern viewpoint, all of these are different manifestations of the same thing, with the last being the most general, but each has a tradition and may be useful in particular contexts, so each is treated in turn. A more extensive review of human spatial sensitivity may be found in Olzak and Thomas (Olzak & Thomas, 1986).

5.4.8.1 Threshold vs Size

In general, thresholds for small circular disk targets against a uniform background decline in proportion to area, so that the product of contrast (or luminance) and area is constant. This is known as Ricco's Law, and it suggests complete summation of light energy within a small area. This complete summation occurs only up to a critical size, which varies with light level and other parameters. For brief peripheral flashes in the dark-adapted eye, using rod vision, the critical diameter is about 1° , and the threshold at that size is about $-5 \log \text{cd}\cdot\text{m}^{-2}$ (Hood & Finkelstein, 1986). The critical diameter is reduced by increases in background light level or duration. For short duration (8.5 ms) on a bright background, it is about 0.4° , and for long durations (930 ms) on a bright background, it is about 0.2° (Barlow, 1958). Beyond the critical diameter, thresholds continue to decrease with size, but at a slower rate, especially for long durations or bright backgrounds.

Figure 5.4-6 shows data for disk targets on various background light levels (Blackwell, 1946). In this experiment, observers scanned a uniform background 10° in diameter to locate a circular disk target at one of eight possible known positions. The total exposure duration was 6 seconds. Log adapting luminance ($\log \text{cd m}^{-2}$) is shown next to each curve. The horizontal axis is scaled by a factor of two so that Ricco's Law is indicated by a line at -45° , as shown by the gray lines extending from the first data point. Of the eight light levels shown, only the three brightest, at the bottom of the figure, are photopic. Note that at these brightest levels (which are not particularly bright) the curves begin to converge. This illustrates that, at photopic levels, contrast thresholds are nearly constant with light level, as noted above in the discussion of light adaptation. On these photopic backgrounds, the lowest threshold is 0.0077, or just under 1% contrast, for a target of 2° diameter.

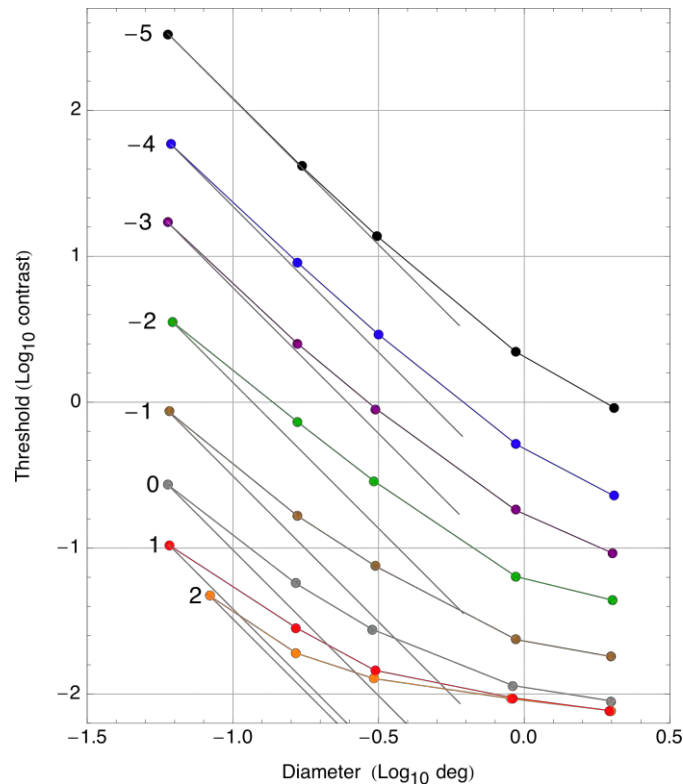


Figure 5.4-6 Contrast threshold as a function of target diameter (Blackwell, 1946).

5.4.8.2 Acuity

Acuity refers to the smallest size pattern that can be identified. In practice, acuity is measured as the smallest size of a set of specific patterns (optotypes) that can be identified with some specified probability, at a specific distance. Often both near (0.4 m) and far (6 m) acuities are measured, though the latter is more common. There is a wide range of optotype sets, as well as specific testing and scoring methods. Two example optotypes are shown in Figure 5.4-7. On the left is a Sloan letter, on the right is a Landolt ring. The red gridlines are provided to show size and geometry. At the standard size, the gridlines are 1 arcmin apart. The Sloan letters are a set of 10 letters in whose standard size the individual strokes are all 1 arcmin wide, and the total height and width are 5 arcmin (NAS-NRC, 1980). Acuity is defined as the smallest letter size M arcmin that can be identified 50% of the time, relative to the standard size of 5 arcmin. The Landolt ring (or Landolt C) is actually the same as the Sloan C, and consists of a ring with a gap of 1 arcmin at the standard size. The observer is asked to identify the location of the gap, which may occur at any of four positions (top, bottom, left, right).

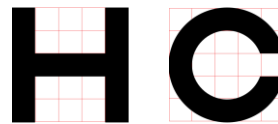


Figure 5.4-7 Example acuity targets.

Acuity may be reported as the decimal value of the required magnification, that is, the ratio of the threshold size to the standard size $M/5$. Often this score is reported as logMAR, given by the \log_{10} of the decimal acuity. The traditional measures such as 20/40 refer to the testing distance (numerator) and the product of the magnification and the testing distance (denominator). So-called 20/20 acuity corresponds to $\log\text{MAR} = 0$. Actual mean logMAR acuity for young adults is about -0.1 (Ohlsson & Villarreal, 2005).

Acuity depends weakly on light level (Rabin, 1994), as shown in Figure 5.4-8. The horizontal and vertical scales are equal. Once photopic levels are reached, further increases in light level produce only modest improvements in acuity. Acuity also declines somewhat with age (see below), and declines strongly with distance from the fovea.

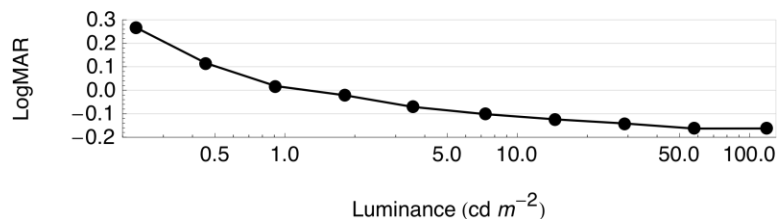


Figure 5.4-8 Acuity vs. light level (Rabin, 1994).

5.4.8.3 Spatial Contrast Sensitivity Function

Spatial summation (threshold vs. size) measures the smallest amount of contrast that can be detected in a large, uniform target, while acuity measures the smallest high-contrast target that can be distinguished. A more general measure of spatial sensitivity that can encompass both of the previous metrics is the spatial contrast sensitivity function (SCSF). The SCSF specifies the contrast required by a human observer to detect a so-called grating target: a sinusoidal modulation of contrast in one spatial dimension. To a first approximation, early visual processing of the spatial image may be regarded as a filtering operation, and the SCSF provides an approximation to the modulation transfer function (MTF) of the filter.

Several examples of sinusoidal gratings are shown in Figure 5.4-9. These examples vary in spatial frequency, specified by the number of spatial cycles per degree of visual angle, and the contrast: a) 2 cycles/image, 0.5 contrast; b) 2 cycles/image, 1.0 contrast; c) 8 cycles/image, 1.0 contrast. Measurement of the SCSF consists of a determination, for each of a number of spatial frequencies, of the minimum contrast required for detection.

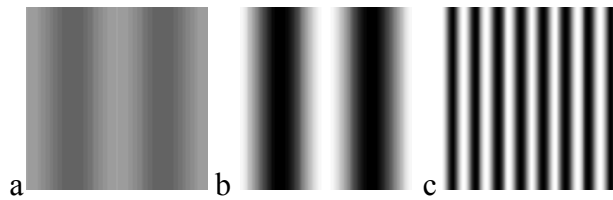


Figure 5.4-9 Sinusoidal grating targets varying in spatial frequency and contrast.

Example data are shown in Figure 5.4-10 (van Nes & Bouman, 1967). They illustrate a number of the fundamental features of the spatial contrast sensitivity function. Consider first the overall shape of the uppermost curve, obtained for patterns superimposed on a relatively bright background. The curve is bandpass in shape, with a contrast sensitivity peak of about 2.7 log units (about 500) at around 4 to 8 cycles/degree. At high frequencies, there is a rapid decline, approaching a minimum (log sensitivity = 0) at around 50 to 60 cycles/degree. There is also a more modest decline in sensitivity at frequencies below the peak.

In intuitive terms, the peak value of the function indicates the smallest contrast that can be detected by vision. Under optimal conditions of measurement (high luminance, large grating, static presentation, long duration, young observer), this is about 0.002. The frequency at which the peak occurs (around 4 cycles/degree or a stripe width of 0.125°) indicates the size of the image element to which the observer is most sensitive. The high frequency limit, at around 60 cycles/degree (a stripe width of 0.5 arcmin), indicates the smallest size of image element that can be detected.

The separate curves show that as light level increases, contrast sensitivity increases. However, it should be noted that this data covers a very wide range of light levels: only the uppermost three curves lie in the photopic range, and in that range, the increase in sensitivity with light level is much smaller. A second change with adapting level is a shift toward higher spatial frequencies, showing that as light level increases, resolution increases. And with increases in light level, there is also a change in shape from low-pass to bandpass, as the attenuation at low frequencies emerges.

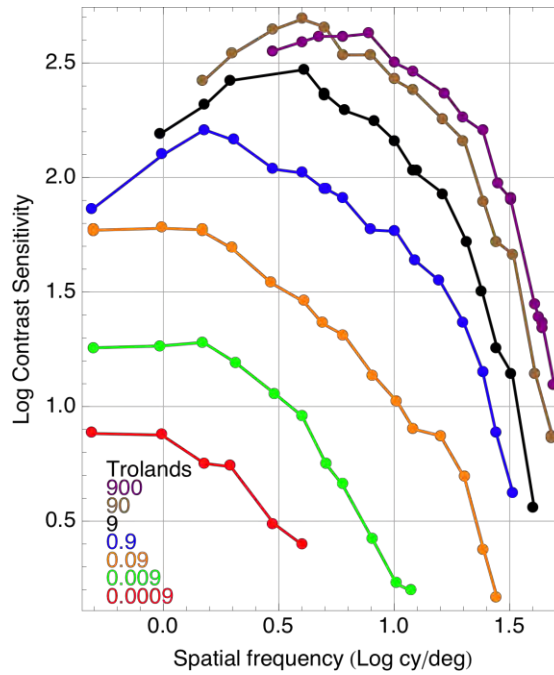


Figure 5.4-10 Contrast sensitivity functions for various light adaptation levels (van Nes & Bouman, 1967).

The SCSF has also been shown to depend on the size of the grating (Carlson, 1982), the location of the grating in the visual field (Koenderink et al., 1978; Robson & Graham, 1981; Rovamo et al., 1978), and the temporal frequency of the grating. In the last case, the grating is not presented statically, but its contrast is modulated sinusoidally over time. This yields results like those shown in Figure 5.4-11 (Robson, 1966). For the slowest rate of modulation (1 Hz), the results are similar to those for static targets. For higher rates, sensitivity declines and the overall curve becomes more low-pass. It is possible to combine spatial and temporal contrast sensitivity functions to create a spatio-temporal contrast sensitivity function (STCSF).

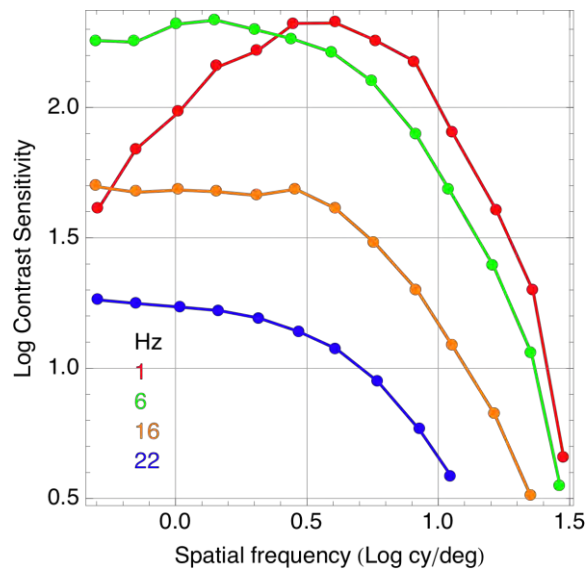


Figure 5.4-11 Spatial contrast sensitivity as a function of temporal frequency (Robson, 1966).

Eccentricity (distance from the point of fixation) has a profound effect on spatial contrast sensitivity (Koenderink et al., 1978; Robson & Graham, 1981; Rovamo et al., 1978). To localize the target, while avoiding the complicating effects of sharp edges, it has been found useful to use Gabor patterns, which are the product of a Gaussian distribution (which governs the size) and a sinusoid. Figure 5.4-12 shows the sensitivity to Gabor patterns as a function of spatial frequency and eccentricity (Robson & Graham, 1981). The curves are for different spatial frequencies, as indicated by the key (h and v indicate horizontal and vertical). Eccentricity is plotted in cycles of the Gabor spatial frequency, and all of the curves can be seen to decline at about the same rate. The gray line shows a decline of 1/40 log units per cycle. This means that high spatial frequencies fall in sensitivity much more rapidly than do low frequencies. For example, to decline by a 2, any frequency must be moved about 12 cycles away from fixation. For 24 cycles/degree, this is only 0.5 degree, while for 3 cycles/degree, it is 4 degrees.

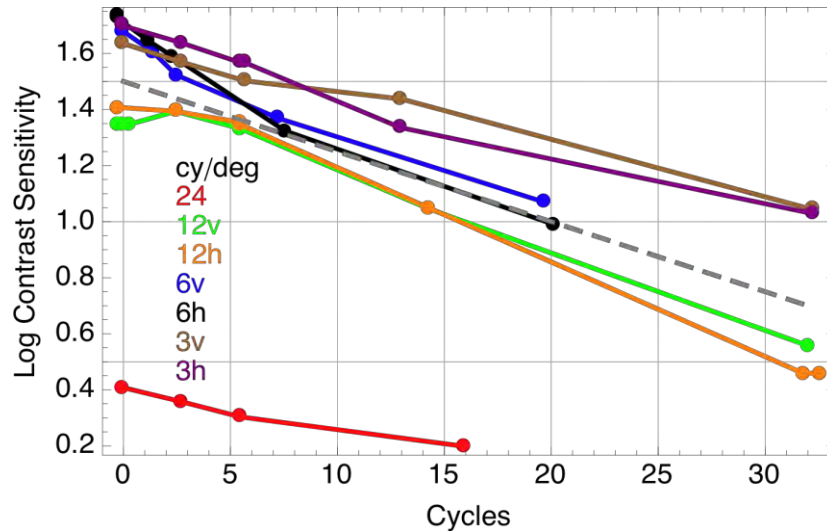


Figure 5.4-12 Contrast sensitivity for Gabor patterns as a function of eccentricity in cycles (Robson & Graham, 1981).

5.4.8.4 Masking

Visual sensitivity to spatial patterns can be markedly reduced by the presence of other patterns. This phenomenon is known as visual masking (Legge & Foley, 1980; Watson & Solomon, 1997). The strongest masking occurs when the mask is superimposed on the target. In general, masking increases as the contrast of the mask increases and as the similarity in frequency and orientation, and degree of superposition of test and mask increase. When the mask is noise or a superimposed grating, masks are effective only if they are within about 1 octave in spatial frequency of the target.

A related phenomenon is crowding, in which nearby patterns can greatly reduce the recognizability of a target pattern (Pelli et al., 2007). Crowding is primarily or exclusively a phenomenon of peripheral vision, but may have strong implications for design of displays.

Masking and crowding are important in the design of information displays. It is important that some display elements not mask others. In general, masking will become a problem when too much information is presented in too small a space. This is a reason to select or design display layouts that are simple and uncluttered, and contain only essential information.

5.4.8.5 Models

A number of mathematical formulas have been constructed that compute contrast sensitivity functions for parameters such as light level, grating size, and peripheral location (Barten, 1992; Rohaly & Owsley, 1993). However, a primary motive for use of the SCSF is to enable predictions of visibility for arbitrary spatial patterns, and these formulas fall short of this goal. Subsequent models provide methods to compute detection thresholds for arbitrary non-grating targets (Daly, 1993; Lubin, 1993), but these models are complex and as a result may be cumbersome to use.

More recently, a simple computational algorithm has been developed that predicts contrast thresholds for arbitrary foveal contrast patterns. This Spatial Standard Observer (SSO) incorporates a filter based on the SCSF, as shown in Figure 5.4-13 (Watson & Ahumada, 2005). The 2D filter on the right incorporates both the one-dimensional filter on the left and an effect of orientation (Watson & Ahumada, 2005). The SSO may be used in a variety of practical applications such as design of displays.

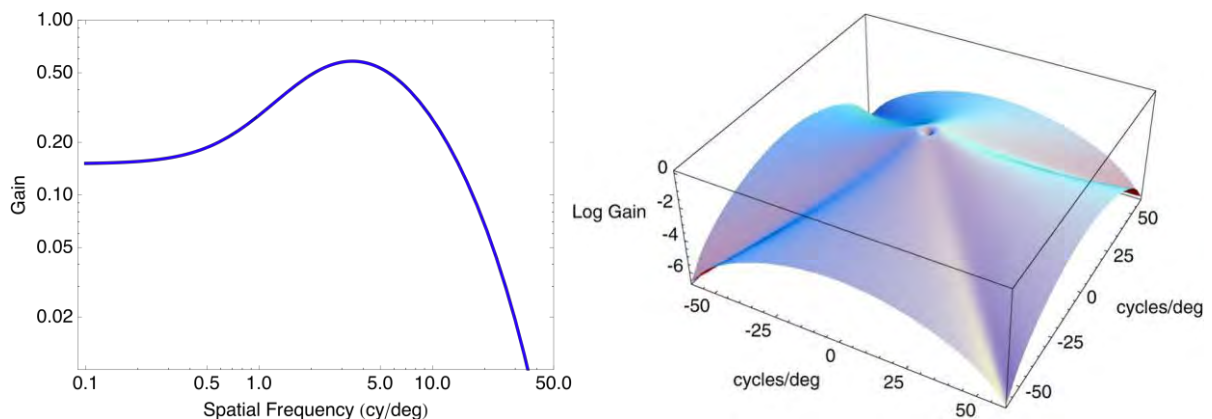


Figure 5.4-13 Spatial contrast sensitivity filter of the Spatial Standard Observer.

5.4.8.6 Effects of Age

Both contrast sensitivity and acuity decline with age in adults. In the case of contrast sensitivity, the decline is most pronounced at medium and high spatial frequencies, and absent at the lowest frequencies. From the 20s to the 80s, in the absence of obvious ocular pathology, contrast sensitivity at 16 cycles/degree declines by about 0.1 log unit per decade, while logMAR acuity declines by about 0.07 log unit per decade (Owsley et al., 1983). From ages 65 to 85, acuity declines about 0.09 log units per decade, and peak contrast sensitivity declines about 0.11 log unit per decade (Rubin et al., 1997). Thus from the peak of sensitivity in the 20s, by the 80s both acuity and peak sensitivity may have declined by as much as 55% to 70%.

5.4.8.7 Summary

- For moderate-size targets on moderate photopic backgrounds, contrast threshold is around 0.01.
- Minimum contrast threshold is around 0.002.
- Normal logMAR acuity in young observers is around -0.1 .
- The spatial contrast sensitivity function (SCSF) provides a general description of visual spatial sensitivity.
- The most visible spatial frequency is approximately 4 cycles/degree.
- The upper limit of contrast sensitivity is about 60 cycles/degree.

- Contrast sensitivity and acuity increase with adapting light level, but are largely unaffected at photopic levels.
- Contrast sensitivity is strongly affected by temporal modulation.
- Contrast sensitivity declines with eccentricity at about 1/40 log unit per cycle of spatial frequency.
- Acuity and contrast sensitivity in adults decline with age by 0.07-0.11 log unit per decade.

5.4.9 Temporal Sensitivity

5.4.9.1 Definition

The stimulus for vision is distributed over time, and the nature of that distribution can affect the visibility and appearance of the stimulus (Watson, 1986). Temporal sensitivity is relevant to any source of visual information that is brief or rapidly changing. A commonplace but important example is the apparently smoothly changing brightness of stroboscopic displays such as film and television.

Analogous to spatial sensitivity, three types of measurements have been used to characterize temporal sensitivity. These are temporal summation, critical fusion frequency, and the temporal contrast sensitivity function.

5.4.9.2 Temporal Summation

Temporal summation describes how light or contrast is summed over time. It is usually measured by varying the duration of a rectangular time pulse of light, and measuring the threshold at each duration. The spatial pattern is fixed, but as will be noted below, the results depend somewhat on the nature of the spatial target.

Figure 5.4-14 shows threshold as a function of duration for light increments to a disk target of the specified background level and 1° in diameter (Roufs, 1972). Here background refers to the brightness of the disk before and after the increment; the spatial area outside the disk (the surround) was dark. On a bright photopic background, contrast thresholds decline approximately in proportion to duration, up to a duration of about 30 ms. This reciprocity between contrast and duration is called Bloch's Law, and the point at which it ceases to hold is called the critical duration. The gray line at lower left illustrates a slope of -1, characteristic of Bloch's Law. For dimmer backgrounds, the critical duration is longer, approaching 100 ms for the dimmest photopic backgrounds. Similar results have been found for peripheral targets, and for foveal grating targets. A more extensive review of this literature is available (Watson, 1986).

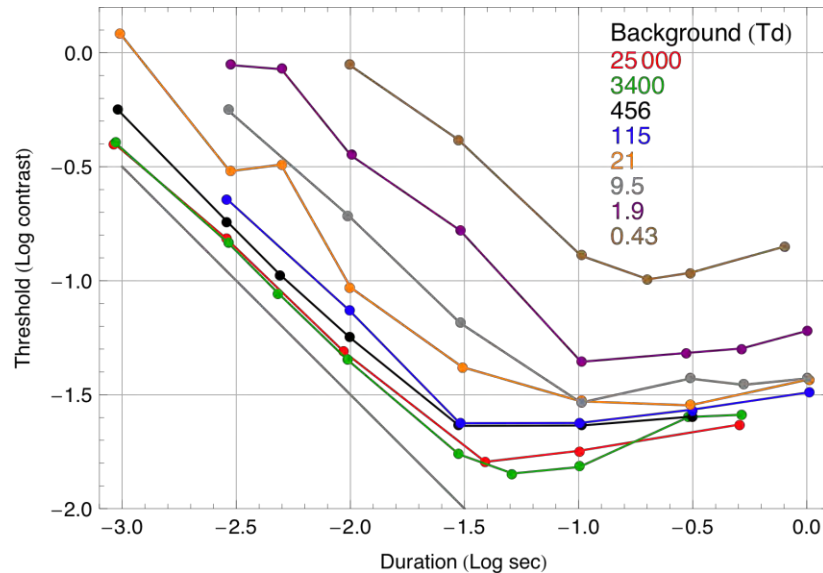


Figure 5.4-14 Contrast threshold for a 1° disk as a function of duration on various background light levels (Roufs, 1972).

Beyond the critical duration, thresholds seem to follow one of two patterns. For targets that are large or have low spatial frequency, threshold remains approximately constant regardless of duration, or may even rise slightly (see Figure 5.4-14). For targets that are very small or have high spatial frequency, thresholds continue to decline with duration, but at a more gradual rate.

Bloch's Law is consistent with perfect integration of the signal over time, and its prevalence has led to shorthand statements that "the eye integrates over a period of 100 ms." However, measurement of thresholds for pairs of brief pulses shows this is not strictly correct. Pairs of pulses with opposite signs can be more visible than pairs with the same sign, suggesting differentiating effects as well. To accommodate both integrative and differentiating effects, it is useful to consider a more general time filter, which leads to consideration of the temporal contrast sensitivity function.

5.4.9.3 Temporal Contrast Sensitivity Function

A more general approach is provided by the temporal contrast sensitivity function (TCSF), which describes the contrast threshold for sinusoidal temporal modulations of various temporal frequencies (De Lange, 1958). Examples of the TCSF for various retinal illuminances are shown in Figure 5.4-15. This figure is strikingly similar to the comparable data for spatial contrast sensitivity (Figure 5.4-11), with Hz exchanged for cycles/deg. At photopic levels (≥ 100 Td), the curve is bandpass, with pronounced falloff at both high and low temporal frequencies. Sensitivity depends strongly on light level over the full range of levels, but only slightly at photopic levels. The peak sensitivity here is around 200 Td, though this will depend on the other dimensions of the target, especially the spatial dimensions.

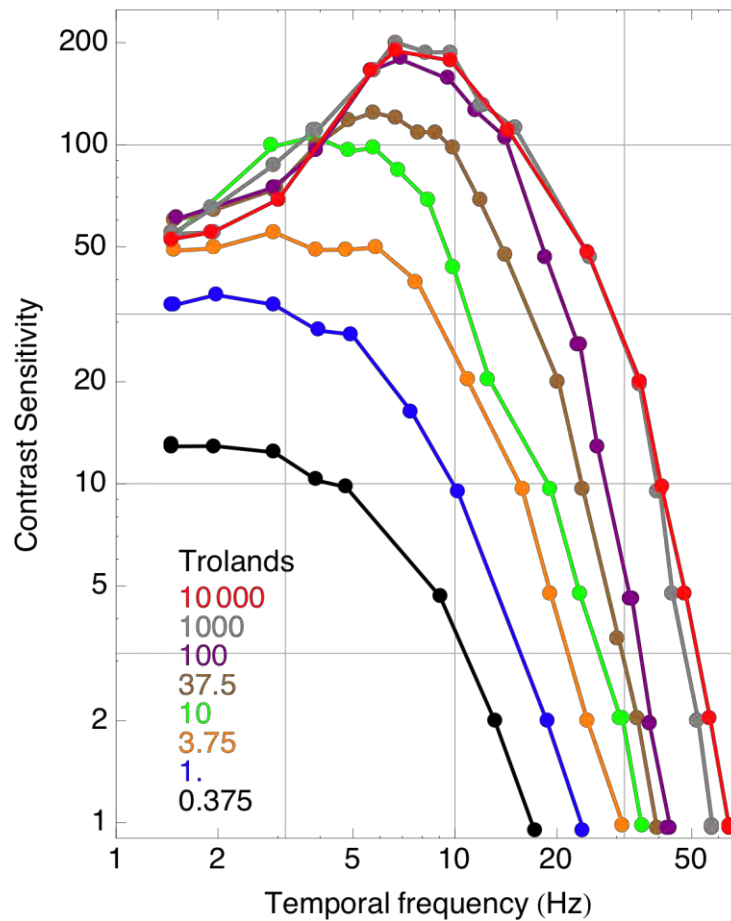


Figure 5.4-15 Temporal contrast sensitivity function at various light levels (De Lange, 1958).

5.4.9.4 Critical Fusion Frequency

The critical fusion frequency (CFF) is the highest frequency that can be seen at a contrast of 1, or in other words, the frequency at which a unit contrast flickering light seems to fuse into a steady one. This is illustrated by the points in Figure 5.4-15 at a contrast of 1, and as can be seen, they increase in frequency with light level, ranging from below 20 Hz to above 60 Hz. This is shown more comprehensively in Figure 5.4-16, which shows CFF vs. retinal illuminance for several wavelengths of light. The illuminance is measured in photopic trolands, which is why the curves converge at photopic levels and diverge at scotopic levels.

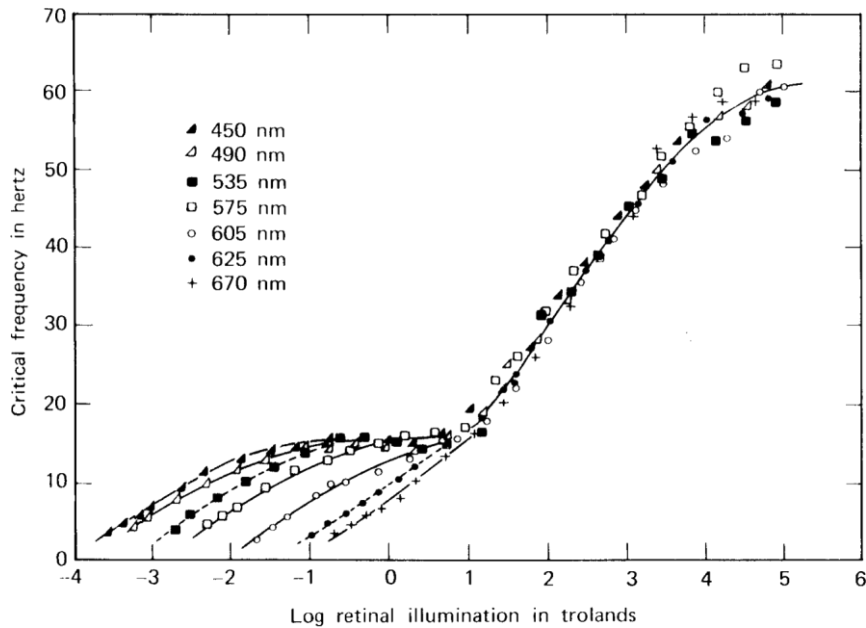


Figure 5.4-16 Critical fusion frequency as a function of retinal illuminance for various wavelengths (Hecht & Shlaer, 1936).

5.4.9.5 Spatial and Chromatic Effects

As noted in section 5.4.8, “Spatial Sensitivity,” spatial and temporal contrast sensitivity are interdependent. This is illustrated in Figure 5.4-17, which shows the TCSF as a function of the spatial frequency of a grating target. For a low spatial frequency, the curve is bandpass, but for medium to high spatial frequencies, it is low-pass. As noted above, spatial and temporal sensitivity can be combined into a single STCSF (Burbeck & Kelly, 1980, Koenderink & van Doorn, 1979). A highly simplified version of this function, called the Window of Visibility, defines a visible region of spatial and temporal frequency (Watson et al., 1986). This concept can be useful in predicting visibility of artifacts in visual displays. If the desired display and the actual display differ only in spatial and temporal frequencies that lie outside the window of visibility, then those differences will be invisible, and the actual display is satisfactory.

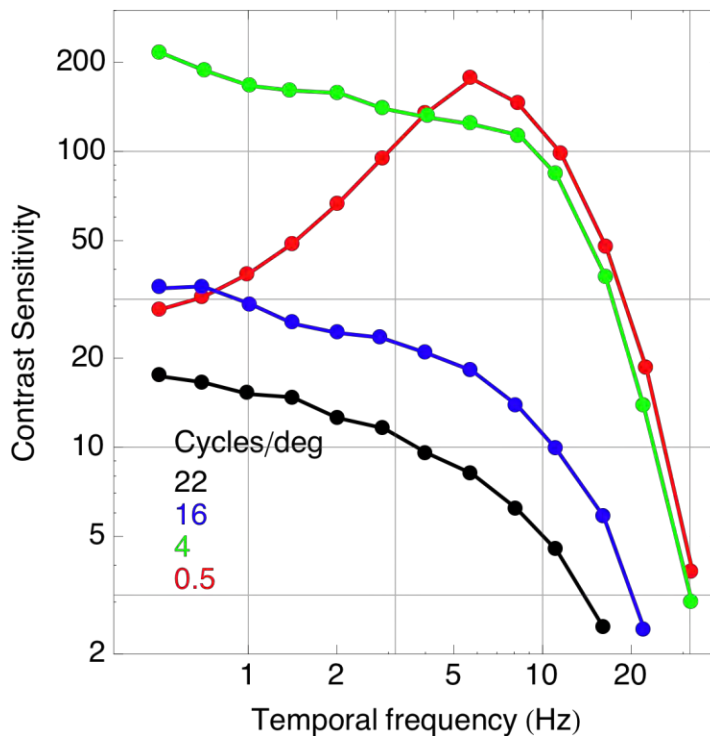


Figure 5.4-17 Temporal contrast sensitivity at various spatial frequencies (Robson, 1966).

Temporal sensitivity also depends on color, being much faster for luminance modulation than for chromatic modulation, as discussed below in the section on color (Varner, 1984). However, it is rare in practical situations that temporal modulation occurs exclusively in isoluminant dimensions, so sensitivity is usually governed by the luminance modulation.

5.4.9.6 Models

A simple linear filter model of temporal contrast sensitivity consists of the difference of two leaky integrators, which can be expressed as gamma densities,

$$h(t) = S \left[\Gamma(t; n_1, \tau) - T \Gamma(t; n_2, \kappa\tau) \right] \quad (5)$$

where $\Gamma(t; n, \tau)$ is a gamma density with parameters n and τ , n_1 , n_2 , τ , and $\kappa\tau$ are the parameters of each integrator, S is an overall sensitivity constant, and T is a measure of the transience of the response: when $T = 0$, the response is low-pass; when $T = 1$, the system is bandpass and there is no response to a constant input. Fits of this function to a range of TCSF data from various stimulus configurations yield parameters in the range of $S = 200-270$, $T = 0.9-1$, $\kappa = 1.33$, $n_1 = 9$, $n_2 = 10$, $\tau = 4.3-4.9$ ms (Watson, 1986). If this filter is followed by a Minkowski summation over time with an exponent between 3 and 4, the resulting model provides a good account of the visibility of both periodic and aperiodic temporal stimuli.

5.4.9.7 Motion Sensitivity

A moving target corresponds to a particular distribution of contrast over space and time. Sensitivity to moving targets can usually be understood in terms of the underlying spatial and temporal contrast

sensitivities (Watson, 1986). For example, a vertical sinusoidal grating of f cycles/deg moving horizontally at a speed of v deg/s has a temporal frequency of $f v$ cycles/s (Hz). Its contrast threshold can be determined by noting the value of the STCSF at f cycles/deg and $f v$ Hz. More complex moving targets can be decomposed into their spatio-temporal frequency components by way of the Fourier transform, and their resulting visibilities deduced in a similar way.

5.4.9.8 Summary

- For pulses less than 30 to 100 ms, threshold depends on the product of contrast and duration.
- Temporal sensitivity is well characterized by the TCSF.
- At photopic light levels, the TCSF peak is around 4 to 8 Hz, and the CFF is around 60 to 70 Hz.
- The TCSF depends strongly on light level over the full range, but only a little at photopic levels.
- The TCSF depends strongly on the spatial and chromatic content of the target.
- Simple linear filter models with nonlinear integration can explain many temporal thresholds.
- For targets that vary in both space and time, such as moving targets, the STCSF may be used to predict visibility.

5.4.10 Color Vision

Color consists of visual responses to variations in the wavelength dimension of the visual stimulus (Hunt, 2004; Kaiser & Boynton, 1996; Shevell, 2003). In nature, these variations usually arise from varying spectral reflectance of objects, and we attribute the resulting subjective experience of color to the objects. Color is thus an important attribute that humans use to identify objects, but is now also widely used in visual communication systems.

5.4.10.1 Color Specification

In the “Luminance” sections, the distribution of energy over wavelength was reduced to a single number, the luminance. In the photopic region of intensity (approximately $> 10 \text{ cd} \cdot \text{m}^{-2}$), an extended source, such as a patch of uniform color in a display, can be characterized by a distribution of energy over wavelength (spectral radiance), which is written as $I(\lambda)$ and specified in units of $\text{W} \cdot \text{sr}^{-1} \cdot \text{m}^{-2} \cdot \text{nm}^{-1}$. Color vision obeys the principle of univariance, which asserts that two lights yielding the same number of quanta absorbed by the three types of color photoreceptors (cones) will yield the same color sensation. This in turn leads to the principle of trichromacy, which states that any colored light can be visually characterized by three numbers: the quanta absorbed in the three types of cones, or indeed by any fixed invertible transform of those absorptions. Thus every spectral energy distribution can be reduced to three numbers. A specific standard transformation was established in 1932 by the CIE (CIE, 1932). In this transformation, the three numbers, known as tristimulus values, are given by

$$\begin{aligned}
 X &= K \int I(\lambda) \bar{x}(\lambda) d\lambda \\
 Y &= K \int I(\lambda) \bar{y}(\lambda) d\lambda \\
 Z &= K \int I(\lambda) \bar{z}(\lambda) d\lambda
 \end{aligned}
 \tag{6}$$

where \bar{x} , \bar{y} , and \bar{z} are the so-called CIE 1931 color-matching functions, and K is a constant of $683 \text{ lm}\cdot\text{W}^{-1}$. For convenience, \bar{y} is equated to the photopic spectral luminosity function $V(\lambda)$, so that Y is equal to luminance.

Trichromacy is somewhat complicated by modern findings of pigment polymorphism, which indicate that individuals may possess multiple variants of single pigments, but it remains a useful and standard approximation.

5.4.10.2 Chromaticity Coordinates

The chromaticity coordinates of a light are given by a normalization of the tristimulus values,

$$\begin{aligned} x &= \frac{X}{X+Y+Z} \\ y &= \frac{Y}{X+Y+Z} \end{aligned} \quad (7)$$

These quantities form the axes of the CIE 1931 Chromaticity Diagram, as shown in Figure 5.4-17. In this diagram, the boundary of the colored region is the spectrum locus, the set of all visible monochromatic lights. All visible lights lie within that boundary, and Figure 5.4-18 illustrates their approximate color. Color-capable photometers usually measure the luminance Y and the chromaticity coordinates x and y.

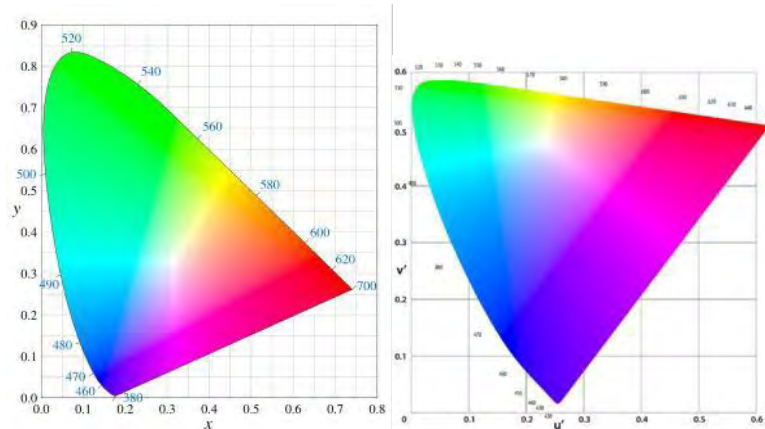


Figure 5.4-18 CIE 1931 and 1976 chromaticity diagrams.

It has been shown that a different chromaticity space can provide a more nearly uniform space, in the sense that equal distances correspond to equal apparent color differences. This is the CIE 1976 Chromaticity Diagram, illustrated in Figure 5.4-18. It is a simple transformation of the CIE 1931 coordinates:

$$\begin{aligned} u' &= \frac{4x}{-2x + 12y + 3} \\ v' &= \frac{9y}{-2x + 12y + 3} \end{aligned} \quad (8)$$

5.4.10.3 Color Difference Metric

Color-difference metrics convert a pair of colors into a measure of the magnitude of their perceptual difference. In general, these measures are valid only for “small” color differences, and become less accurate for larger differences. These metrics have proven useful for establishing color specifications, errors, and tolerances. Color-difference metrics can establish the tolerances around display color primaries and mixture colors, aid the selection of color palettes, and provide estimates of display color performance under varying illumination conditions (Brainard, 2003).

The CIE L*u*v* and CIE L*a*b* color-difference metrics are the most widely used and verified in practice. Comparisons of the predictive performance of these two metrics have revealed that the CIE L*a*b* metric provides the more accurate and consistent predictions of perceptible color differences. Although CIE L*a*b* remains in widespread use, it has been superseded by both the CIE94 and CIE2000 color-difference metrics, which contain component weighting factors to improve overall color-difference estimates.

The CIE L*a*b* metric is defined by a nonlinear transformation of XYZ tristimulus values:

$$\begin{aligned}
 L^* &= 116 \frac{(Y)^{\frac{1}{3}}}{\left(\frac{Y_n}{n}\right)} - 16 \\
 a^* &= 500 \left[\frac{(X)^{\frac{1}{3}}}{\left(\frac{X_n}{n}\right)} - \frac{(Y)^{\frac{1}{3}}}{\left(\frac{Y_n}{n}\right)} \right] \\
 b^* &= 200 \left[\frac{(Y)^{\frac{1}{3}}}{\left(\frac{Y_n}{n}\right)} - \frac{(Z)^{\frac{1}{3}}}{\left(\frac{Z_n}{n}\right)} \right]
 \end{aligned} \tag{9}$$

where $X_n Y_n Z_n$ are the tristimulus values for a defined nominal white. The perceptual distance between two colors is then obtained by computing their respective differences in each of these quantities, and combining them as follows:

$$\Delta E^* = \sqrt{(\Delta L^*)^2 + (\Delta a^*)^2 + (\Delta b^*)^2} \tag{10}$$

This difference metric applies directly only to patches of uniform color viewed side by side, and cannot by itself be applied to differences between color images. A recent proposal to extend CIE L*a*b* to images uses a separate spatial filter for each of three linear color channels, followed by transformation of each pixel to CIE L*a*b* (Zhang et al., 1997).

5.4.10.4 Opponent Color Representations

For both theoretical and practical reasons, colors are often represented in an opponent representation, usually consisting of a luminance component and two color-difference components, one red-green and the other blue-yellow. This opponent representation is important because, as shown below, these three opponent channels have markedly different spatial and temporal sensitivities. Furthermore, most processing of color at higher levels in the visual system is more easily understood in terms of these channels.

5.4.10.5 Spatial and Temporal Aspects of Color Vision

Spatial contrast sensitivity depends markedly on the color dimension over which the spatial modulation occurs (Mullen, 1985; Poirson & Wandell, 1993). Figure 5.4-19 shows contrast sensitivity functions for: (on the left) a green grating (modulation of luminance), and a red-green grating (color but no luminance modulation); (on the right) a yellow grating (luminance modulation), and a blue-yellow grating (color but no luminance modulation). When luminance is held constant, chromatic spatial contrast sensitivity is shifted toward lower frequencies by about a factor of four relative to luminance spatial contrast sensitivity. This much lower resolution of the chromatic opponent pathways is the basis for important efficiencies in image and video coding.

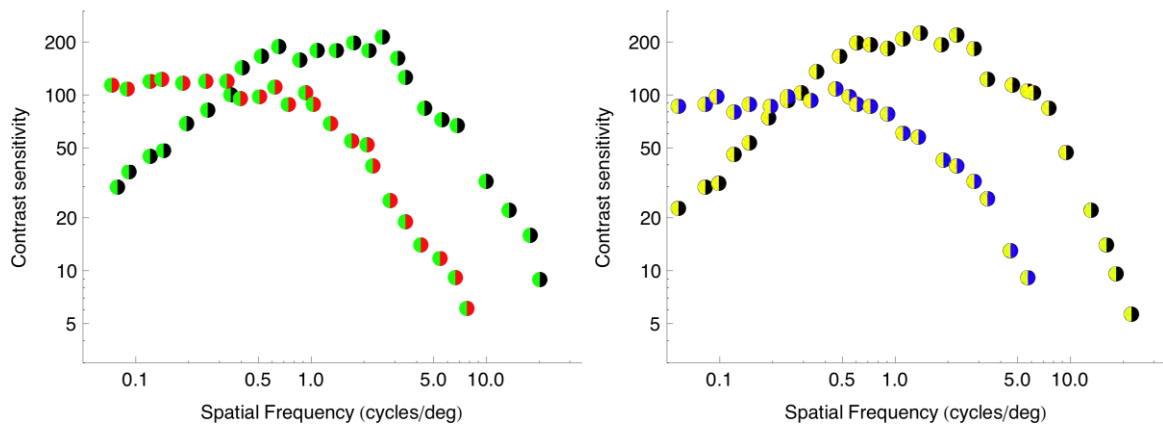


Figure 5.4-19 Spatial contrast sensitivity for luminance and chromatic modulation (Mullen, 1985).

5.4.10.6 Anomalous Color Vision

Anomalous color vision describes individuals whose color discriminations depart significantly from the standard observer. The major classes are rod monochromats (who lack all cones), cone monochromats (who have only one type of cone), dichromats (who have only two types of cone), and anomalous trichromats (who have three types of cone, one of which is anomalous). Dichromats are further divided according to which cone they lack: protanopes (L cone), deuteranopes (M cone), and tritanope (S cone). Anomalous trichromats are similarly divided into protanomalous, deuteranomalous, and tritanomalous. Anomalous color vision is much rarer in females than in males, having an incidence of less than 0.5 % (Gegenfurtner & Sharpe, 1999). In men, total incidence may be as high as 8%, with deuteranomaly the most common at about 4.6%, and with the other L and M cone cases at about 1% each. S cone defects are much rarer (around 0.002%), and probably equally common in both sexes.

From a human factors perspective, anomalous color vision presents a caution for either crew selection or the use of color to convey information. Because color is a powerful and ubiquitous dimension of visual experience and visual communications, it would be unwise to minimize or prohibit its use, but care should be taken in critical cases to ensure that relevant information is available to the crew.

5.4.10.7 Color Naming and Color Search

Color is a highly effective aid to visual segregation and cuing for visual search, but becomes less effective as the number of colors exceeds nine, or if the colors are not optimally chosen. Research supports the concept that there are eleven basic color terms, which are more reliable than others as well as easier and faster to name and discriminate (Boynton, 1989). These color terms are red, green, blue, yellow, orange, pink, purple, brown, gray, black, and white. Subsets of these colors have been shown to

segregate well in search tasks, though alternative color sets that are equally discriminable, but not basic, segregate just as well (Smallman & Boynton, 1990).

5.4.10.8 Color Context and Color Appearance

Color appearance is strongly influenced by visual context. Adapting backgrounds, or nearby or surrounding colors, may markedly alter the apparent color of an isolated patch. These effects are complex, though models are available to predict simple configurations (Moroney et al., 2002). When the specific appearance of a color is important, for example as a cue in an information display, care should be taken to ensure that the appearance is consistent in the contexts expected.

5.4.10.9 Summary

- On a neutral background, color is determined by the distribution of light over wavelength.
- Color can be specified by CIE tristimulus values.
- Color differences can be specified by CIELab color-difference metrics.
- Color is reduced in rapidly varying targets, or in very small or high-frequency patterns.
- Color context can have powerful effects on color appearance.

5.4.11 Other Visual Phenomena

5.4.11.1 Glare

Glare refers to the disabling effects of light that is too bright, either everywhere in the field of view (for example, at the beach), or more commonly, from one or a few sources that are away from the point of fixation. The light from the glare source is scattered within the eye, thereby reducing the contrast of the objects of interest. Glare is rare in interior environments, but outdoors may be caused by the sun during the day or bright lights at night. Corrective measures include visors or sunglasses (for uniform glare) or shades or rearranged working conditions in the case of localized glare. As noted below, in space, glare may be a particular problem during EVAs or on the lunar surface.

Formulas have been developed to estimate the effect of glare, by converting it into an equivalent veiling luminance. One example is

$$L_v = 9.2 \sum_{i=1}^n \frac{E_i}{\theta_i (\theta_i + 1.5)} \quad (11)$$

where L_v is the equivalent veiling luminance, E_i is the illuminance in lux at the eye of the i th glare source, and θ (theta) is the angle between fixation and the i th glare source. This veiling luminance is added to the actual luminances of target and background to compute the effective contrast (Rea, 2000).

5.4.12 Vision During Space Flight

5.4.12.1 Effects of Space Flight on Vision

Using handheld and ground-based targets during Gemini missions, Duntley found no significant change in acuity (Duntley et al., 1971). More extensive measurements on Space Shuttle missions found a significant but very small (0.04 logMAR) decrease in acuity relative to ground-based preflight and

postflight measurements (O'Neal et al., 1992). It should be noted that these missions were brief; the longest testing interval on Shuttle missions was 8 days.

Recently, evidence has emerged of significant changes in visual acuity following long-duration space flight (Mader, Gibson, Pass, Kramer, Lee, Fogarty, et al., 2011). Figure 5.4-20 shows largely hyperopic shifts averaging 0.84 diopters (D) observed in seven astronauts following ISS missions of 6 months. Each color is one astronaut; circles and squares indicate right and left eyes, respectively. Among these same seven astronauts, ophthalmic findings included disc edema (5), globe flattening (5), choroidal folds (5) cotton wool spots (3), and nerve fiber layer thickening (6). Postflight questionnaires completed by short-duration and long-duration mission crews indicate that 29% and 60%, respectively, report degradation in visual acuity.

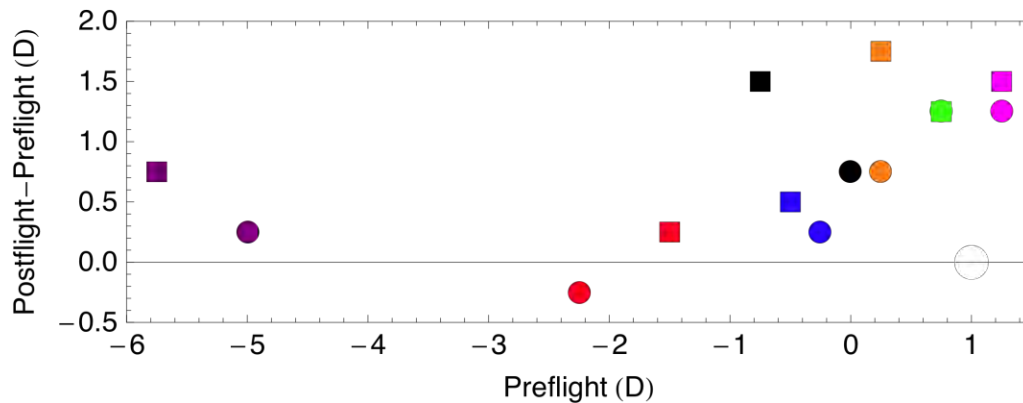


Figure 5.4-20 Refractive change in seven astronauts after long-duration space flight.

In a subsequent retrospective study of MR data from 27 astronauts, of 15 subjects with more than 30 days of cumulative lifetime exposure to microgravity, 40% showed posterior globe flattening (Kramer et al., 2012). Analysis also revealed various combinations of optic nerve sheath distension, optic disc protrusion, and increased optic nerve diameter. These results were hypothesized to result from intracranial hypertension, itself the result of cephalad fluid shifts.

One notable visual phenomenon of space flight is light flashes caused by interactions between energetic cosmic ray particles and elements of the visual system. These flashes occur at rates from 0.1 to 0.5 per minute, depending on shielding and other obstructions (Avdeev et al., 2002; Casolino et al., 2003; Fuglesang et al., 2006; Herrick, 1974; McNulty et al., 1977; Yasui & Ohtsuka, 1986).

5.4.12.2 Visual Environment in Space

The NASA Bioastronautics Databook provides a useful overview of the visual environment in space (Parker & West, 1973). The space lighting environment poses several challenges for vision, primarily due to the absence of an atmosphere. This lack somewhat increases light levels relative to sunlight on Earth (perhaps 25% greater), but more prominently eliminates indirect lighting from the sky (

Figure shows a number of examples of luminances that may be encountered in space, in the context of the complete range of operation of the visual system). Thus almost all natural light is direct, and consequently shadows are very dark, illuminated only by starlight or reflections from nearby objects. Brighter illuminated areas and darker shadows lead to very high luminance contrasts, but more significantly pose a challenge for light adaptation. An eye adapted to brightly illuminated surfaces will

have difficulty seeing objects in the shadows. And as noted above, dark adaptation following bright light may take several minutes. Likewise the unfiltered sun, especially at low sun angles of the sort encountered at the lunar poles, will create long shadows and pose a large risk of glare. Various strategies for ameliorating these effects have been proposed (Colford, 2002; Kaiser & Ahumada, 2008). The absence of an atmosphere also removes one cue to visual distance: atmospheric haze. This may lead to poorer estimates of the distance to remote objects. However, the absence of haze should significantly enhance visual ability to discern small targets at far distances.

EVA's pose additional lighting challenges. Low Earth orbit results in a 1.5-hour light-dark cycle, with about half of that in dark. Combined with possible motion of the astronaut relative to the sun and objects being observed or manipulated, these conditions result in a radically changing and sometimes difficult lighting environment.

Many visual activities in space contend with windows or visors, which may introduce distortions of shape or location, or may reduce contrast or produce multiple images. Additionally, special treatments such as coatings or polarization may distort colors or reduce visibility of polarized sources (e.g., LCD displays). Care should be taken in the design of windows, visors, and tasks to ensure that the necessary visual information is not obscured.

Weightlessness eliminates the natural basis for a unique visual vertical direction, and this has been reported to be the cause of disorientation and motion sickness (Colford, 2002). On the ISS, this has been dealt with by designing interiors with a consistent vertical.

Several anomalous conditions that may be encountered in space missions have potentially deleterious visual effects, notably g forces, hypoxia, reduced barometric pressure, and vibration (Tredici & Ivan, 2008). Accelerations of greater than +3.5G_z may cause loss of peripheral vision, while accelerations greater than +4G_z may cause complete loss of vision (blackout). At 4.5G to 6G, consciousness may be lost. Hypoxia produces well-known progressive deleterious effects on first night vision, then daylight vision. Reduced barometric pressure has been reported to produce transient scotoma (blind spot) or hemianopia (blind half-field). Vibration reduces acuity by blurring the target, and frequencies above 15 Hz that approach or exceed flicker fusion are likely to be the most problematic. The amount of blur will depend on the amplitude of vibration and the axis in which it occurs.

5.4.13 Vision Correction

RESERVED

5.4.14 Mesopic vision

RESERVED

5.4.15 Research Needs

- Efficient evaluation of visual function – Long-duration space missions will impose the need for testing of visual function during the course of the mission, both to ensure readiness for mission tasks and to anticipate possible decline or change in visual function. Research is needed to design a suite of tests that is broad, effective, reliable, and within mission constraints of time, space, energy, equipment, and workload.
- Visual quality metrics – Standards for visual quality of visual communications, such as requisite bitrates for digital video, are at present difficult to define, due to a lack of relevant research. Research that evaluated perceived quality as a function of bitrate for various video formats would be

helpful. More helpful still would be human vision models capable of providing this information without the need for human testing. These models could be developed from current models of spatial, color, and temporal sensitivity described above.

- Standard model of spatial contrast sensitivity – A very large number of standards in visual human factors depend on the human visual contrast sensitivity function. This function has been measured often, but existing measurements conflict and no standard data set has been designated. In addition, existing data did not adequately consider display calibration or the optical status of the observer. Careful, calibrated measurement of the CSF, combined with simultaneous measurement or correction of observer wavefront aberrations, would help to establish a standard dataset. This dataset would be able to distinguish between optical and neural components of the CSF. This in turn would allow prediction of CSFs for specified human populations, varying by age or degree of optical correction. This standard dataset could also serve as the basis for more reliable models of contrast detection, acuity, legibility, display quality, image, and video quality.

5.5 AUDITORY PERCEPTION

5.5.1 Introduction

Human perception of, and response to, sound is important for understanding how to design audio communication systems. While human auditory function is well understood, little evidence is available regarding changes in function during space flight. However, several factors (e.g., air pressure and air composition that are different from those in Earth environments, the effects of noise, the impact on sound of confined spaces such as spacecraft) should be considered in designing crewed spacecraft and extravehicular activity (EVA) suits. Auditory perceptual and cognitive factors should also be considered when designing user interfaces and controls. This section describes the nature of sound, and human response to and perception of it.

Discussion pertaining to acceptable noise levels under various conditions and phases of flight are described in section 6.6, “Acoustics.”

5.5.2 The Nature of Sound

5.5.2.1 Sound Propagation

The phenomenon of sound is caused by a physical disturbance of molecules within a medium—air, water, or solid—that can be detected by a listener. We are familiar with the atmospheric pressure of air molecules from barometric readings; the average atmospheric pressure at sea level is 101.325 kilopascals (kPa; a pascal is defined as 1 newton of force applied over an area of 1 meter squared). Changes in atmospheric pressure occur far too slowly to be audible. However, an object such as a loudspeaker that can vibrate at a frequency within the range of human hearing, approximately 20 to 20,000 cycles per second for a healthy young person, are experienced as sound.

In air, the cycles of sound vibration refer to the compression and rarefaction of air molecules that causes a series of low- and high-pressure moments in time, and is commonly referred to as a sound wave. A simple sound wave such as the sinusoid shown in Figure 5.5-1 has two fundamental properties: frequency and pressure. Frequency is typically referred to in units of hertz (Hz) to refer to cycles per second. In this example, the pressure excursions of the sound wave about the midpoint occur at a frequency of 50 cycles per second, or at 50 Hz (once every 20 milliseconds).

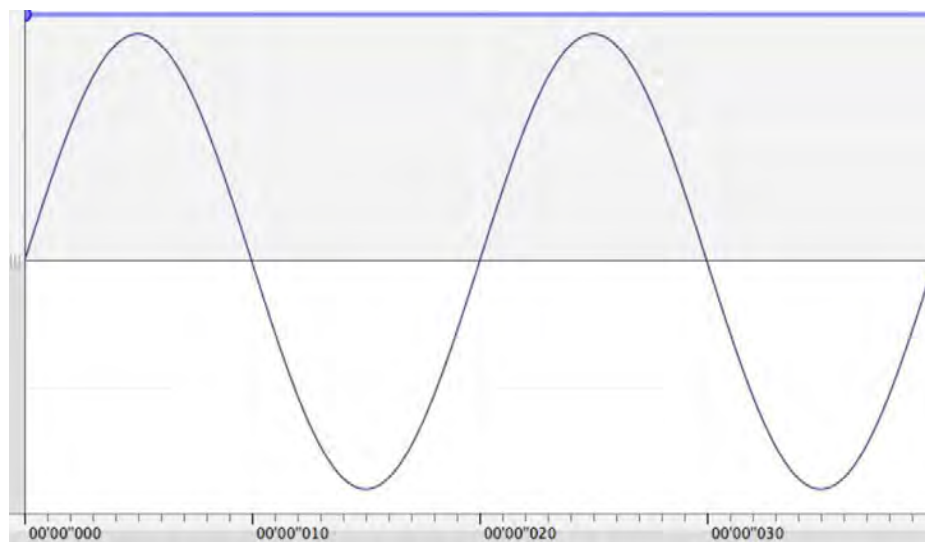


Figure 5.5-1. A graphic representation of a sinusoidal sound wave.

Knowing the speed and frequency of sound, it is possible to calculate a sound's wavelength, the distance from one pressure peak to the next. The speed of sound in air varies with altitude and temperature; a good approximation is 344 m/s (1,128 ft/s). The wavelength is calculated as the speed of sound divided by the frequency. Therefore, a 50-Hz waveform is about 6.88 m (22.6 ft) long, measured from pressure peak to the next pressure peak.

The concept of sound pressure relates to the magnitude of the positive and negative pressures shown in Figure 5.5-1. The range of sound pressures that humans can detect is remarkable. The quietest sound a healthy young person can hear is equivalent to 20 micropascals (0.00002 Pa), while the loudest sound a person can hear without pain is about 200 Pa. This is a 10,000,000-to-1 change in magnitude! A logarithmic unit known as the decibel (dB) is used to compress this range of magnitudes into a more convenient range of 0 to 140 decibels. In acoustics, the mathematical definition of sound pressure level (SPL) expressed in decibels is a ratio of two pressures:

$$L_p = 20 \cdot \log_{10}(P_1/P_0)$$

where P_0 is defined by international agreement as a sound pressure level of 0.00002 pascals, in most cases the quietest sound that can be heard; and P_1 is the averaged pressure of the sound under measurement. Thus, when $P_1 = P_0$, the sound pressure level is at the standardized reference level of 0 dB. Table 5.5-1 compares the range of sound pressures and of sound pressure levels in pascals and sound pressure levels in decibels, for example sound sources.

Table 5.5-1 The Relationship Between SPL and Pressure Ratios for Typical Sound Examples

Sound Pressure (Pa)	Sound Pressure Level: $20 \cdot \log_{10}(P_1/P_0)$	Example
200	140	Threshold of pain
20	120	Near a jet aircraft engine
2	100	Near a jackhammer
.2	80	Typical factory
.02	60	Normal conversation @ 1 m
.002	40	Quiet living room
.0002	20	Quiet recording studio
.00002	0	Threshold of hearing

Outdoors, particularly in a free field or in an anechoic chamber where there are hypothetically no effects of the environment, sound pressure is attenuated as a function of increasing distance from a source. Indoors, a sound source reaches a listener not only by a direct path but also by striking or grazing over objects, reflecting and refracting back toward the listener via additional reflected paths, in a manner similar to that of a light beam in a room full of mirrors. Acoustically, reflected paths are heard and

measured as reverberation. The effect of reverberation, particularly in small to medium-sized rooms, is to cause the overall sound pressure of a sound source to attenuate less as a function of distance than it would in a free field. In some cases, reverberation can cause the sound pressure level to be constant independent of the position of the sound source and the receiver.

In the space environment, sound propagation may be affected by such factors as atmospheric pressure and breathable gas mixtures that, in turn, may affect the perception of auditory signals. At sufficiently low pressures, sound transmission will be degraded so that crewmembers may have to speak louder to be heard at a given distance. As discussed in Lange et al. (2005), pressures below about 69.0 kPa (10 psia) result in degradation of a crewmember's ability to understand speech. The use of helium as a diluent has also raised concerns about verbal communication. Because of helium's low density, it causes a high-pitched distortion of the sound coming from the vocal cords, which may result in decreased intelligibility.

5.5.2.2 Sound Measurement

The ability to measure and then analyze the magnitude and frequency of sound waves has important practical applications for the design of audio displays, communication systems, environmental quality, and hearing conservation. A sound level meter is typically a calibrated, hand-held device used to quantify sound pressure level, but can also be a fixed device. It is designed to respond in approximately the same manner as the human ear so as to provide objective, repeatable measurements. All sound level meters consist of a microphone, a processor, and a data readout-memory. In simplest terms, the microphone converts sound pressure into an electrical signal, the processor applies frequency and time weightings to the input signal, and the data readout indicates the measured values to the user for analysis.

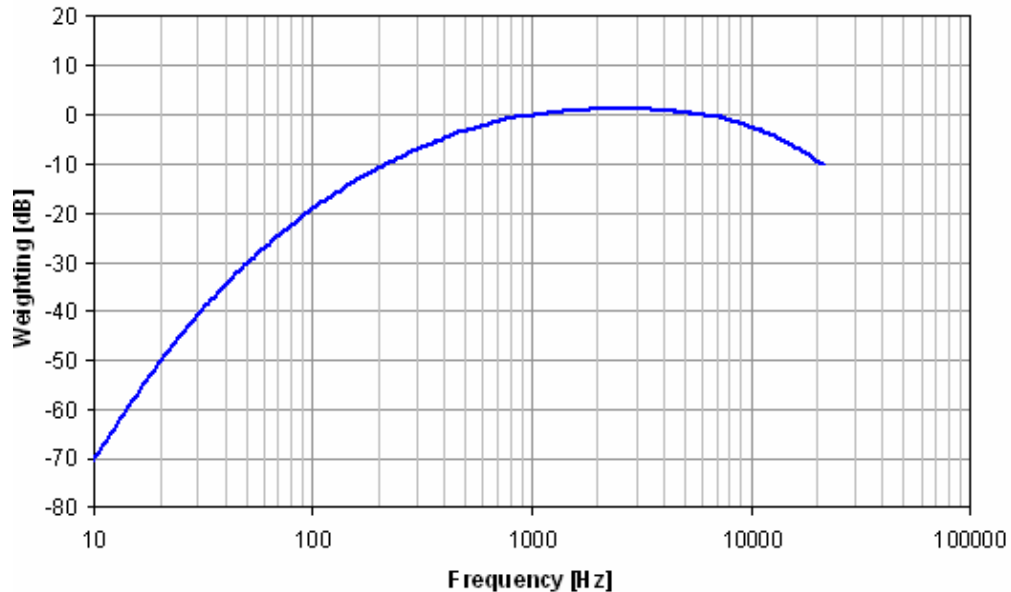
Frequency and time weighting is applied in the processing stage of sound measurement to make statistical descriptions of sound (e.g., peak or average level) and/or to make the measurements better correspond to human perception.

Time weighting refers to the integration of energy by the meter over a time interval. Most sound pressure measurements fluctuate rapidly on a moment-to-moment basis, making it necessary in most cases to integrate the variation in level across a time constant. Typically encountered time weightings include "fast" and "slow" time constants, which integrate energy exponentially over a period of 125 ms and 1.0 s, respectively. For detection of short bursts, such as noise from impacts, that can potentially harm hearing, the peak level is sometimes reported, which uses no time weighting other than the fastest interval that the measurement device is capable of sampling at, which is usually < 1 ms.

Although a meter can indicate an unweighted ("linear") value of sound pressure, it is often useful to apply a frequency weighting that reflects the human ear's sensitivity. The most common frequency weighting that is used in noise measurement is "A-weighting", which compensates for the fact that the ear is comparatively less sensitive to lower and very high frequencies. Figure 5.5-2 shows A-weighting. (According to ANSI Y10.11, the preferred method for indicating weightings is in the subscript of the level: for example, 60 A-weighted decibels with slow time weighting would be expressed as $L_{AS} = 60$ dB. However, it is more common to attach an A to the decibel indication although the decibel itself is not weighted; thus, the common usage would be "60 dBA").

Predicted risks of hearing damage are based on the noise source's level (typically reported in dBA) and duration of exposure. Sound measurements can be expressed statistically as an average level. One common application is to report the sound energy of sounds fluctuating over a measured period as being equivalent to a constant sound pressure level, notated as L_{eq} . For example, when acoustic dosimetry measurements are made in space flight missions, the data are reported in terms of a "16-hour crew work

period noise exposure level” (or $LA_{eq, 16h}$) and an “8-hour crew sleep period noise exposure level” (or $LA_{eq, 8h}$; ISS Flight Rule B13-152).



The frequency weighting corresponds to perceived loudness, and is commonly applied in acoustical engineering. (<http://www.diracdelta.co.uk/science/source/a/w/aweighting/source.html>).

Figure 5.5-2. Frequency weighting for dBA.

In the next sections, the relationship between the physical parameters of sounds, such as intensity and frequency spectra, and their corresponding perceptual qualities will be considered.

5.5.3 Auditory Response to Sound Intensity

5.5.3.1 Absolute Thresholds

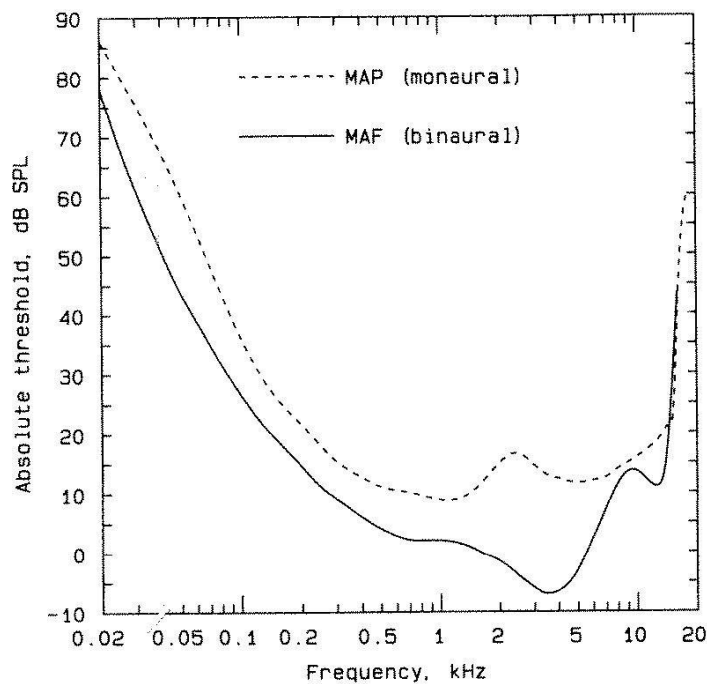
The absolute threshold of human hearing is defined as the minimum detectable level of a sound in the absence of any other sounds. Absolute threshold data delineates the lower end of the human sensitivity range for intensity; this threshold for human hearing is defined statistically, often as an average of hearing thresholds obtained in healthy ears. At the upper level of sensitivity, at about 110-120 dB SPL, sounds will begin to cause discomfort or pain and even short-term exposure to levels above 115 dB SPL may cause permanent damage to the ear. Also, the ability to detect a change in intensity begins to deteriorate at about 100 dB SPL. In between these extremes is the “working region” of the auditory system.

There are two primary methods for measuring absolute thresholds, the minimum audible pressure (MAP) and the minimum audible field (MAF).

- The MAP is the detection threshold for a sound under earphones and is measured using a small probe microphone placed as near to the eardrum as possible. The sounds (typically a sine wave with duration greater than 200 ms) are delivered to one ear via headphones.
- The MAF is the detection threshold for a sound in a sound field and is measured by presenting the sounds over a loudspeaker in an anechoic chamber (International Standards Organization

[ISO] 389-7, 1996). After the listener has indicated when a sound is at threshold, the level of the sound is measured at the position of the listener, but with the listener absent.

Absolute thresholds are measured as a function of frequency. Figure 5.5-3 shows the mean thresholds for many listeners for the MAP and MAF as a function of frequency and intensity. Both the MAP and MAF show greatest sensitivity in the region of 1 to 6 kHz with a steep rise in thresholds for both the low and high frequencies. Note that the binaural MAF thresholds are consistently about 6 to 10 dB lower than the monaural MAP. This is due to the fact that binaural hearing is more sensitive than monaural hearing since the sound at the two ears is summed by the auditory system. The monaural MAP shows only minor dips and peaks as a function of frequency, while the binaural MAF shows a large dip around 3 to 4 kHz and a peak around 8 to 9 kHz. This difference is produced by a broad resonance resulting from the interaction of sound with the pinna and ear canal that occurs in the MAP procedure. Absolute thresholds may vary considerably for individuals so that a 20-dB difference from the mean threshold at a particular frequency may still be considered “normal.”



The solid curve shows the MAF for binaural listening published in an ISO standard (ISO 389-7, 1996). The dashed curve shows the MAP for monaural listening.

Figure 5.5-3. Minimum sound levels that can be heard (Moore, 2004).

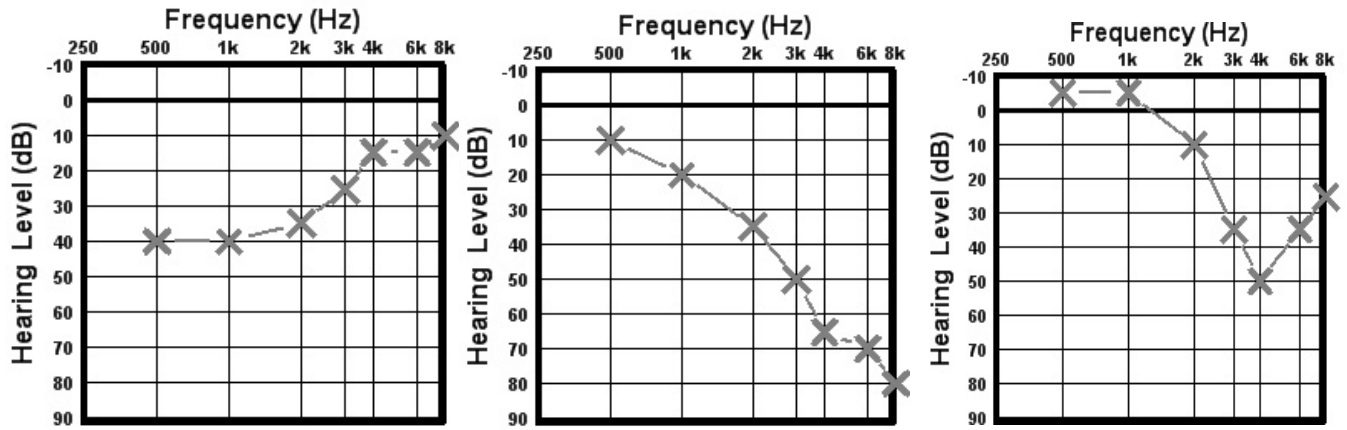
Another factor that influences absolute thresholds is the duration of the sound. Below about 200 ms, the minimum detectable intensity increases as the sound duration decreases; that is, shorter sounds are harder to hear. Above about 500 ms, the minimum detectable intensity is generally independent of duration. This suggests that the auditory system has a time constant for temporal integration on the order of 200 to 500 ms, although it is generally thought to be the result of repeated sampling of the sound (“multiple looks”) rather than a simple energy integrator. There is also some suggestion that this time constant is longer at low frequencies than at high frequencies. However, later studies found little variation with frequency (Moore, 2004).

5.5.3.2 Hearing Loss

Measurement of hearing sensitivity is important when considering health issues such as peripheral hearing loss. Hearing sensitivity is reported using an audiogram, a graph showing an individual listener's hearing level as a function of frequency. Hearing thresholds for pure-tone stimuli are measured with audiometry, using a MAP technique, to determine a given listener's threshold of audibility, or the minimum sound pressure level that is capable of evoking an auditory sensation in a specified function of trials. Pure-tone stimuli are presented to the listener's ears, using an audiometer and earphones that comply with national standards of calibration, so that they will yield equivalent results when used under comparable test conditions. In addition, audiometric testing is conducted in a relatively quiet environment (that must also meet national standards for maximum ambient environmental noise levels), to allow the listener to detect the auditory stimuli. Standardized audiometric test techniques, based on psychophysical principles, are used to obtain hearing thresholds that are then compared to the average values that have been previously measured for many normal, healthy young adults. On the audiogram, these "normal" thresholds are represented as 0 dB hearing level (HL). The individual's thresholds are plotted (usually in 5-dB increments, as shown in Figure 5.5-4) as their HL; that is, the HL is the difference between their measured threshold and the "normal" threshold. Hearing thresholds may be both positive and negative, since a particular individual may be more or less sensitive than the general population at a given frequency. Hearing loss is generally defined by thresholds that are greater than about 25 dB HL, with normal hearing ranging from -10 dB HL to 25 dB HL.

The shapes of audiometric configurations can offer clues to factors associated with the cause of the hearing loss (e.g., excessive stiffness or mass characteristics of middle-ear structures, damage in areas of the tonotopically organized cochlea). See Figure 5.5.4 for examples of audiograms that show hearing thresholds obtained with air conduction audiometry (e.g., using earphones). The cause of hearing loss may be conductive or sensorineural. Conductive hearing loss is produced by a defect in the outer ear or middle ear that results in an attenuation of the incoming sound; it generally manifests as an overall elevation of hearing thresholds. Disorders that cause conductive losses can often be treated by medications or surgery. When such medical treatment of the conductive loss is not feasible, making the sound louder with amplification (e.g., by increased volume on radio headsets or use of hearing aids) is effective in correcting the remaining hearing loss. Sensorineural loss most commonly arises from a defect in the cochlea, but may also result from defects in the auditory nerve or higher levels in the brain. Sensorineural hearing loss does not typically respond favorably to medical treatment, and it is typically described as an irreversible, permanent condition. Like conductive hearing loss, sensorineural hearing loss reduces the intensity of sound, but it might also introduce an element of distortion into what is heard, resulting in sounds being unclear even when they are loud enough. Individuals with sensorineural loss often have trouble understanding speech, particularly in noisy environments. Once any medically treatable conditions have been ruled out, the typical treatment for sensorineural hearing loss is amplification through hearing aids (or, in cases of severe or profound hearing loss, cochlear implants). However, since amplification cannot overcome physiological limitations of sensorineural damage (like changes in frequency specificity and selectivity), hearing aids do not fully restore "normal" hearing in cases of sensorineural hearing loss.

A mixed hearing loss exists when a sensorineural hearing loss occurs with an overlying conductive component.



Comparison of three typical air conduction audiograms, with data plotted in dB HL. Left: Hearing thresholds elevated in low frequencies but normal in highs (may be seen with conductive hearing loss due to middle ear disease, or with sensorineural hearing loss due to disorders that increase inner ear fluids). Center: Hearing thresholds sloping to severe high-frequency hearing loss (may be seen with presbycusis). Right: Normal hearing thresholds in low frequencies (even better than 0 dB HL), but showing significant “notch” at 4 kHz (characteristic of moderate noise-induced hearing loss). Note: actual diagnosis of whether a hearing loss is conductive, sensorineural, or mixed types requires more information than is provided by air conduction audiometry alone. For instance, audiometry can also be performed using a bone conduction oscillator (rather than air conduction earphones) to stimulate the inner ear directly (and bypass the outer and middle ear). When bone conduction hearing thresholds are better than air conduction thresholds at the same frequency, a conductive component is indicated (and the hearing loss is likely not entirely sensorineural in nature)

Figure 5.5-4 Examples of audiometric configurations.

One of the most common forms of sensorineural hearing loss is presbycusis, the hearing loss associated with aging. Presbycusis affects both ears equally and increases with age. It primarily results in loss of the ability to hear high frequencies. Presbycusis may be caused by a variety of age-related health factors, such as atherosclerosis, diabetes, and hypertension, that reduce the blood supply to the cochlea. Table 5.5-2 summarizes the results of a large-scale study by Davis (1995) that shows the percentage of people with losses greater than 20 dB HL and 40 dB HL (when averaging hearing thresholds at frequencies of 0.5, 1, 2, and 4 kHz) for two age populations.

Table 5.5-2 Predictions of Hearing Loss – Reported as an Average of Hearing Thresholds at Four Frequencies: 500, 1000, 2000, and 4000 Hz) as a Function of Age (ACOEM, 2003)

Age Range (years)	Percent of Population with Hearing Loss > 20 dB	Percent of Population with Hearing Loss > 40 dB
61-71	51	11
71-80	74	30

Another common form of sensorineural hearing loss is noise-induced hearing loss (NIHL). NIHL is of particular importance to NASA since astronauts and pilots are often exposed to high levels of noise in training and during missions that can both temporarily and permanently affect their hearing sensitivity.

Long-term exposure to excessive noise may produce both temporary and permanent changes in the responsiveness of the auditory system. Typically, the first sign of hearing loss due to noise exposure is an elevation of hearing thresholds at 3000, 4000, or 6000 Hz, with recovery at 8000 Hz (yielding a “notched” audiogram configuration, as shown in Figure 5.5-4). The exact location of the notch depends

on multiple factors, including the spectrum of the noise and the length of the ear canal. Therefore, in early noise-induced hearing loss, the average hearing thresholds at 500, 1000, and 2000 Hz are better than the averages at 3000, 4000, and 6000 Hz; and the hearing level at 8000 Hz is also usually better than the deepest part of the “notch.” This “notching” is in contrast to age-related hearing loss, which also produces high-frequency hearing loss, but in a down-sloping pattern without recovery at 8000 Hz (i.e., without a “notch”).

Temporary effects from excessive noise exposure include adaptation, in which the apparent magnitude of a sound decreases over time, and fatigue, in which the absolute threshold for the sound increases after exposure as measured by a temporary threshold shift, which is generally small for lower exposure levels, but increases rapidly for sounds above 90 to 100 dBA. According to the World Health Organization (Berglund et al., 1999) “hearing loss is not expected to occur at $LA_{eq, 8h}$ levels of 75 dBA or lower, even for prolonged occupational noise exposures.” This level corresponds to an $LA_{eq, 16h}$ of 72 dBA or lower, using the internationally accepted 3-dB equal energy exchange rate. Furthermore, the WHO states, “It is expected that environmental and leisure-time noise with an $LA_{eq, 24h}$ of 70 dBA or lower will not cause hearing impairment in the large majority of people, even after a lifetime exposure”.

When humans are exposed to high levels of noise, they can experience a temporary threshold shift (TTS), which improves most rapidly within the first 10-14 hours after the exposure. However, recovery times may be quite variable, depending on the nature of the fatiguing sound, and a TTS may last 16 hours or more after exposure to high intensities. If the hearing loss does not resolve (e.g., within 30 days after the exposure), it is considered a permanent threshold shift (PTS) and rarely recovers to pre-exposure levels. Single exposures to levels above 110 to 120 dBA are likely to produce PTS, particularly if the exposure duration is long (and recurs). If no TTS is seen after a noise exposure, no PTS will be generated; any subsequent hearing threshold changes are not attributed to the noise exposure. The rate of hearing loss due to chronic noise exposure is greatest during the first 10 to 15 years of exposure, and decreases as the hearing threshold increases. This is in contrast to age-related hearing loss, which accelerates over time. Noise exposure alone usually does not produce a loss greater than 75 dB HL in high frequencies and 40 dB HL in lower frequencies. However, individuals with superimposed age-related losses may have hearing threshold levels in excess of these values.

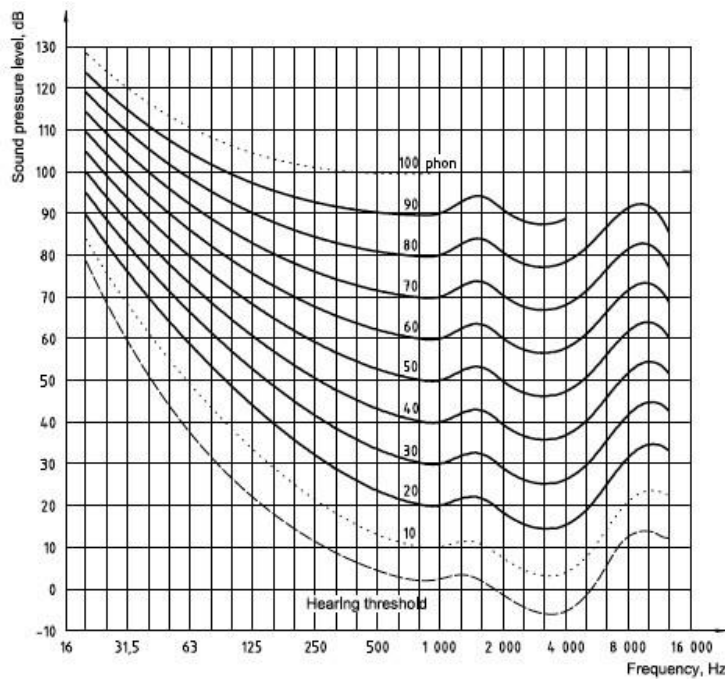
Further information about the impact of noise level and duration on human hearing can be found in section 6.6.2, “Human Response to Noise.”

5.5.3.3 Loudness

Loudness is the perceptual quality most related to the physical parameter of sound intensity, although loudness is also affected by the frequency content of the sound. The sensitivity of the human ear to intensity as a function of frequency can be characterized by a set of equal-loudness contours, originally measured by Fletcher and Munson (1933). These data were based on pure tone stimuli and used a loudness-matching technique in which listeners were asked to adjust the level of a test tone so that its loudness sounded equal to that of a standard tone of 1000 Hz. By definition, the level of the 1000-Hz standard was its level in dB SPL, and the level of the test tone that matched the standard was defined as its level in “phons.” For example, if a 1000-Hz tone at 40 dB SPL is loudness-matched by a 250-Hz tone at 50 dB SPL, both tones are defined as having a loudness level of 40 phons.

In the time since the Fletcher-Munson curves were first published, some disagreement has occurred about the best method for determining loudness levels and the “true” shape of the equal-loudness contours. Recently a new ISO standard (ISO 226:2003) was developed, based on extensive data from

several international laboratories using a binaural MAF procedure ([ISO], 2003). Figure 5.4-5 shows the new data.



The absolute threshold curve and loudness levels from 10 to 100 phons are shown for sounds presented binaurally in front of the listener. Contours for 10 and 100 phons are dashed, as they are based on interpolation and extrapolation of the measured data.

Figure 5.5-5. Equal-loudness contours for pure tones under free-field listening conditions (ISO 226:2003).

Compared to previous standards, very large differences up to about 15 dB occur in the frequency region below 1000 Hz. The overall pattern of the data, however, remains the same. The shape of the equal-loudness contours is similar to the MAF absolute threshold curve; listeners are most sensitive at intermediate frequencies (1000 to 6000 Hz) and less sensitive at lower and higher frequencies. As the phon level increases, however, the contours begin to flatten, so that the rate of growth in loudness with increasing intensity becomes greater at lower and higher frequencies than at intermediate frequencies. Thus the relative loudness of different frequency components in a signal depends on its overall intensity.

The change in tonal balance with overall level has important implications for auditory displays and communication. For example, human voices often sound “boomy” when played over loudspeakers at high levels because when the overall level is high, the ear is relatively more sensitive to low frequencies than high frequencies. For example, for a moderate level of 40 phons, the loudness of a 1000-Hz tone of 40 dB SPL is equal to the loudness of a 125-Hz tone of 60 dB SPL, corresponding to a 20-dB SPL sensitivity difference between the low and high tones. At a higher intensity level of 80 phons, the loudness of a 1000-Hz tone of 80 dB SPL is equal to the loudness of a 125-Hz tone of 90 dB SPL. Thus, at the higher intensity, an increase in SPL of only 10 dB is needed to equalize the loudness of the low and high tones. Further, the relative loudness of a given sound is not easily inferred from its measured intensity level. For example, studies of subjective loudness scaling suggest that the perceived loudness of a sound is proportional to its RMS sound pressure raised to the power of 0.6. Roughly, this corresponds to a doubling of perceived loudness for each 10-dB increase in level. Thus, an 80-dB SPL sound is not twice as loud as a 40-dB sound, rather it is perceived as about 16 times louder.

Other factors that can influence loudness perception include the duration of the sound and its bandwidth (the frequency range present in the signal). As noted above, absolute thresholds decrease with increasing duration up to about 200 ms. Similarly, at a given sound intensity level above absolute threshold, loudness will increase with increasing duration up to about 100 to 200 ms. For durations longer than a few hundred milliseconds, it is difficult for listeners to judge the overall loudness of a sound. Loudness-matching becomes highly variable, depending on which shorter segment (e.g., a particular word or phoneme) within the total signal (e.g., a speech phrase or sentence) the listener has focused on to make the judgment.

Loudness is determined by the spectral distribution as well as the intensity of sound. Loudness tends to be greater if a sound's power is spread over a wider frequency range; this frequency range has to be greater at higher frequencies than at lower frequencies to have an effect on perceived loudness.

5.5.3.4 Loudness and Hearing Loss

Loudness perception may be adversely affected by hearing loss, particularly when there is damage to the cochlea, in a phenomenon known as loudness recruitment. Recruitment is an abnormally rapid increase in perceived loudness with normal increases in sound level. With loudness recruitment, a listener's hearing threshold may be higher than normal, but perception of intense sounds can be considered to be "loud" at levels still considered to be "loud but okay" by a normal listener. Thus, if a simple hearing aid amplifier was to amplify loud sounds (e.g., applause) as much as less intense sounds (a child's solo), someone with loudness recruitment would consider the higher-level sounds to be much too loud. (New digital hearing aids are designed to use compression to limit output levels and not exceed a person's maximum loudness tolerance level, but hearing-impaired users of such hearing aids often still report problems hearing important speech signals in the presence of fluctuating background conversations and noises.) Recruitment is thought to be associated with damage to the outer hair cells in the cochlea, which can be induced by, among other factors, exposure to very intense, impulsive sounds such as those heard during launch, entry, and on-orbit engine burns.

5.5.3.5 Intensity Discrimination

Intensity discrimination is the ability of the auditory system to detect a difference between the intensities of sounds over time. Common methods for measuring intensity discrimination include asking listeners to detect the louder of two successive signals that differ only in their intensity or to detect a brief increase in the intensity of a continuous sound. Over the course of many such trials, the intensity difference is reduced until the listener achieves some criterion such as 75% correct. This "just-noticeable difference" (JND) for intensity discrimination for wideband noise remains approximately constant as the overall baseline level of the sound increases from about 30 to 110 dB SPL (i.e., approximately a +0.4-dB change in level corresponds to a 10% increase from the baseline level). Below a baseline of 30 dB SPL, discrimination deteriorates and the JND increases as the overall level decreases. For example, the noise has to approximately double in intensity to be detectable when the baseline level is around 10 dB SPL. Intensity discrimination for pure tones is somewhat different in that JNDs continue to decrease as the overall baseline level of the sound increases from about 10 to 100 dB SPL. This means that at higher overall levels when sounds are pure tones, listeners can discriminate even smaller differences in intensity than 10%. Other studies have shown that listeners are most sensitive to small changes in a sound's intensity when the task is detection of a brief increment in the intensity of a continuous sound. Listeners can also detect differences of only a few decibels between two complex sounds in which one tone out of several is briefly increased, even if the overall levels of the two sounds are different. That is, listeners are able to compare the relative level of components across frequency and thus detect brief changes in spectral shape.

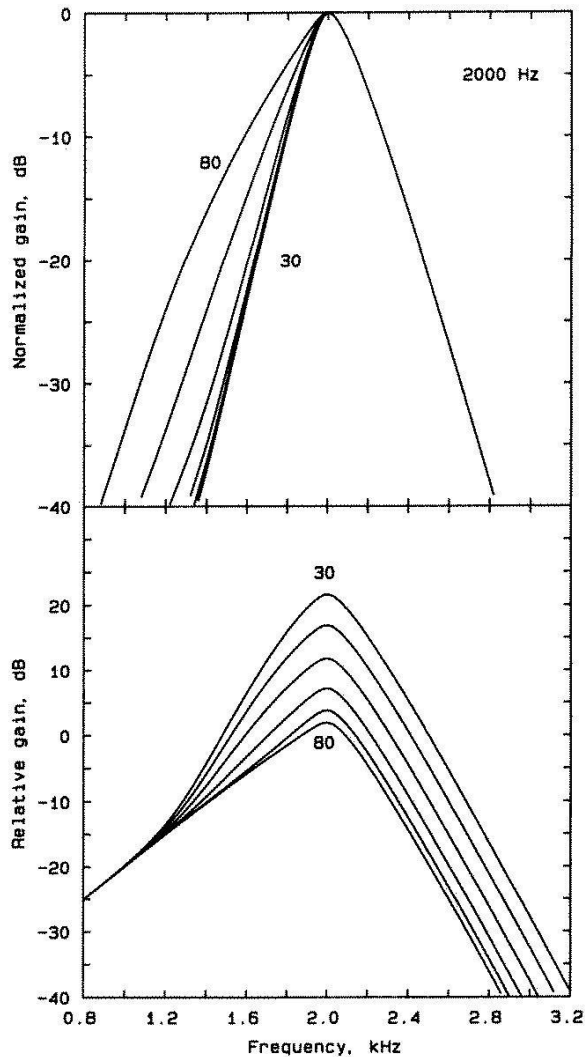
The auditory system's sensitivity to sound intensity, and its ability to discriminate intensity changes across frequency and time, have important implications for the ability of humans to identify individual sound streams as well as simply detect their presence. The upper and lower limits of sensitivity, and the shape of the equal-loudness curves, circumscribe the "working region" of the auditory system across the audible frequency range. Discrimination characteristics affect the ability to understand and distinguish between different sound streams in auditory displays, such as different voices and different caution and warning alerts.

5.5.4 Auditory Response to Sound Frequency

5.5.4.1 Frequency Selectivity and Masking

The frequency selectivity of the auditory system refers to the ability to perceptually resolve or detect the individual sinusoidal components that are present simultaneously in a complex sound. Frequency selectivity affects many aspects of hearing but is most often considered in the context of masking. Masking is defined as "the process by which the threshold of audibility for one sound is raised by the presence of another (masking) sound. The unit customarily used is the decibel" (American Standards Association, 1960). The impact of masking is obvious in everyday experience; speech may be obscured in a noisy environment, or a loud car radio will mask the sound of the engine.

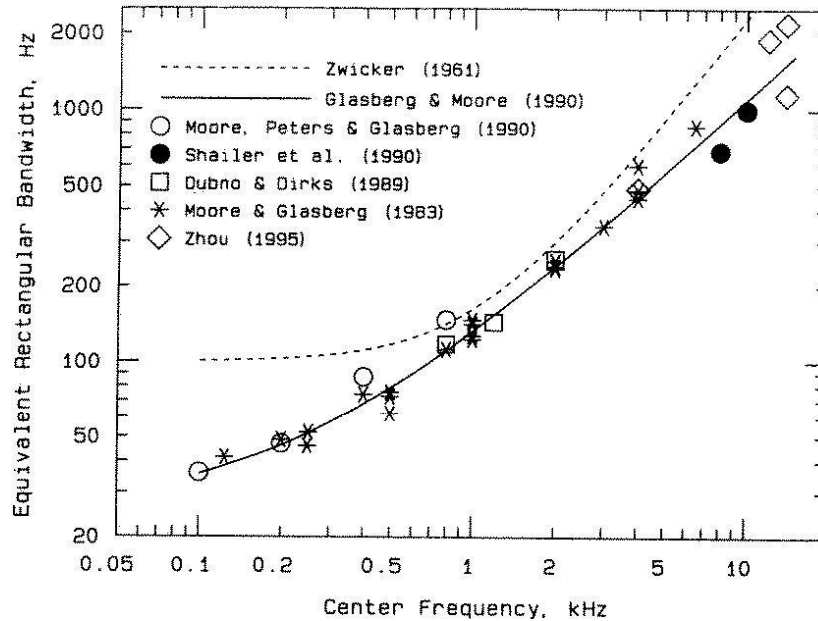
A variety of masking studies over the years have resulted in the concept of the critical band, or auditory filter, as the underlying mechanism for the auditory system's frequency analysis. It seems that the auditory system behaves as though it were composed of an array of overlapping bandpass filters that are determined by the response of the basilar membrane and the outer hair cells in the cochlea to incoming sound. Listeners' percepts of complex sounds depend on whether the sound components fall into one critical band or are spread over several critical bands. Components within the same critical band will mask one another and components in neighboring critical bands may also be masked if one component is sufficiently more intense than the other. As shown in Figure 5.5-6, the shape of the auditory filter at a given center frequency (linear frequency scale) is symmetrical at moderate sound intensities but, with increasing stimulus intensities, the bandwidth broadens and becomes increasingly asymmetrical. The slope of the filter decreases for frequencies lower than the center frequency compared to the slope for the higher frequencies, which remains steep as intensity increases. As shown in Figure 5.5-7, auditory filter bandwidths increase in a roughly logarithmic manner with increasing center frequency and thus the auditory system's resolution decreases with increasing frequency.



The upper graph shows the output of the filter when the output is normalized to have a gain at the tip of 0 dB for every input level. The lower graph shows the filter shapes as gains without this normalization, but assuming that the gain at the tip approaches 0 dB.

Figure 5.5-6. Shape of the auditory filter as a function of level (2000 Hz sinusoidal input; Moore, 2004).

Auditory filter bandwidths are often estimated in terms of their equivalent rectangular bandwidth (ERB). For frequencies above 1000 Hz, the ERB of normal listeners is about 10% to 17% of the center frequency of the filter. Thus, how small a tonal difference can be distinguished depends on the frequency region of the neighboring tones, with greater resolution at lower than at higher frequencies. For example, at a center frequency of 200 Hz, a tone has to be about 20 to 34 Hz away from the 200-Hz tone to be distinguished, while at 1000 Hz, a tone has to be at least 100 to 170 Hz away to be distinguished. Auditory filter interaction and masking has important practical implications for the design of auditory caution and warning alarms, as well as communication systems. For example, in section 10.9.2.3 of the chapter on crew notification and caution and warning (10.9), a case is discussed in which the class 2 and class 3 alarms on the ISS can be confused. When heard at a distance, the high-frequency tonal component of the class 2 alarm is inaudible, while the low-frequency components of the class 2 and 3 alarms are close enough in frequency that they affect neighboring auditory filters and are thus hard to distinguish.



The dashed curve shows the “old” value of the critical bandwidth as a function of frequency (Zwicker, 1961). The solid curve shows the value of ERB of the auditory filter as a function of frequency. This curve was obtained by combining the results of several experiments using Patterson’s notched-noise method of estimating the auditory filter shape.

Figure 5.5-7. Bandwidth of auditory filters as a function of frequency (Moore, 2004).

5.5.4.2 Frequency Selectivity and Hearing Loss

Frequency selectivity is impaired by damage to the cochlea resulting from such factors as exposure to loud noise, reduced oxygen supply (a frequent cause in older adults), or ototoxic agents. With cochlear hearing loss, auditory filters are much broader and flatter than normal, particularly on the low-frequency side of the center frequency (Figure 5.5-8). The perceptual consequence of these broader filters is a greater susceptibility to masking; detecting and discriminating sounds, including speech, in a background of interfering noise or other sounds becomes much more difficult. Moreover, the ability to perceptually analyze complex sounds, such as speech or music, by detecting differences in their spectral content or timbre is impaired. A listener may not be able to distinguish between different consonant sounds, different musical instruments, or different caution and warning signals. A hearing aid that simply amplifies sounds will not correct the difficulties that arise from impaired frequency selectivity. Avoiding or mitigating such hearing damage is an important issue for NASA, as such a hearing disorder will affect the crew’s ability to perform communication tasks and monitor caution and warnings, as well as impair their long-term hearing health.

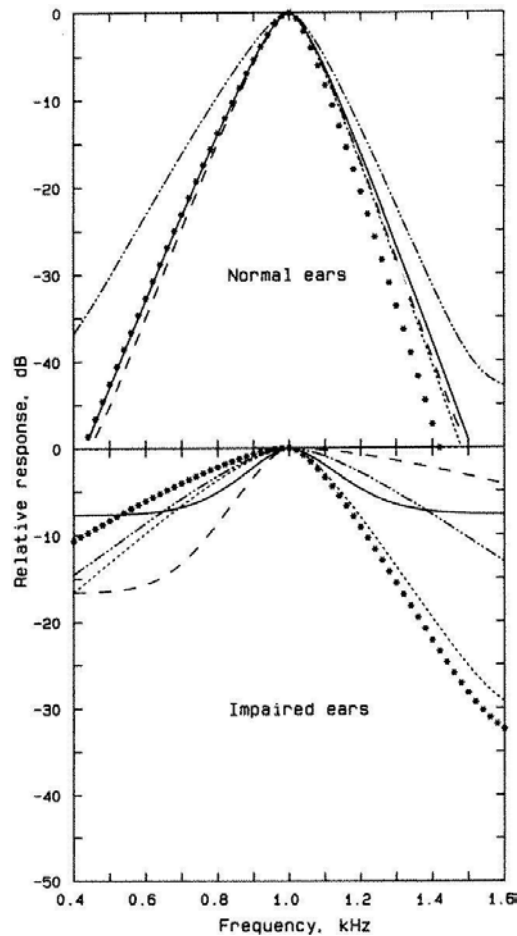
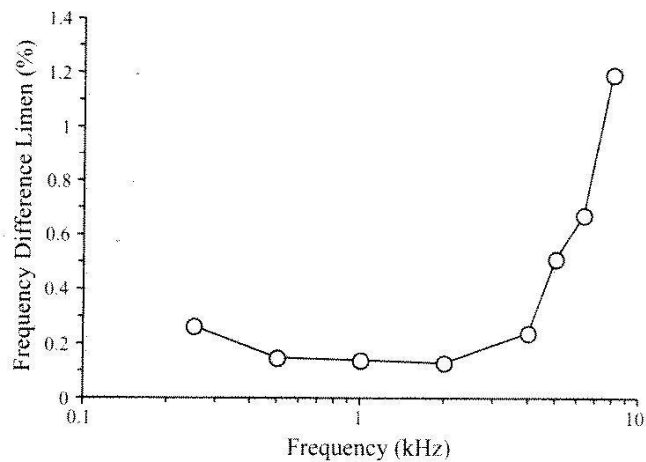


Figure 5.5-8 shows estimation for five subjects, each having one normal ear and one ear with a cochlear hearing loss. The relative response of each filter (in dB) is plotted as a function of frequency. The filter shapes for the normal ears are shown at the top and those for the impaired ears at the bottom. Each line type represents the results for one subject. Note that the filters for the impaired ears are broader than normal, particularly on the low-frequency side.

Figure 5.5-8. Auditory filter shapes for a center frequency of 1 kHz (Moore, 2004).

5.5.4.3 Frequency Discrimination

As discussed previously, frequency selectivity is the ability to resolve the simultaneous components of a complex sound. Frequency discrimination, on the other hand, is the ability to detect changes in the frequency of pure tones over time, as when two tones with different frequencies are presented in succession. Under these conditions, JNDs for frequency discrimination tend to be quite small. Figure 5.5-9 shows that for tones of 4000 Hz or below, the JND is on the order of 0.1% to 0.2% of the frequencies being compared. For example, listeners can just discriminate the difference between a 1000-Hz and a 1002-Hz tone. For frequencies of 5000 Hz and above, the JND increases from about 0.5% to 1.2% at 8000 Hz, corresponding to frequency differences ranging from about 25 to 96 Hz.



The smallest detectable increase in frequency is expressed as a percentage of the baseline frequency.

Figure 5.5-9. Frequency discrimination as a function of frequency for a 200-ms pure tone (Plack, 2005).

5.5.4.4 Pitch

Another important aspect of the auditory response to sound frequency is the sensation of pitch. The American National Standards Institute (1994) defines pitch as “That attribute of auditory sensation in terms of which sounds may be ordered on a scale extending from low to high.” That is, pitch is a subjective quality that gives rise to a sense of melody. Pitch is related to the repetition rate of a sound. For pure tones, this corresponds to the frequency of the sound. For complex periodic tones, pitch is related to the fundamental frequency (i.e., the lowest frequency present that corresponds to the repetition rate of the complex composed of harmonically related tones). For both pure tones and the fundamental frequencies of complex tones, the existence region for pitch ranges from about 30 to 5000 Hz and corresponds roughly to the lowest and highest possible notes of orchestral instruments. Outside of this range, variations in the repetition rate no longer result in a sense of changing pitch or melody.

Frequency analysis begins at the peripheral, or cochlear, level of the ear; the auditory system performs a simultaneous frequency analysis at each ear so that information from the two ears can be compared at higher levels of the brain.

5.5.5 Auditory Space Perception

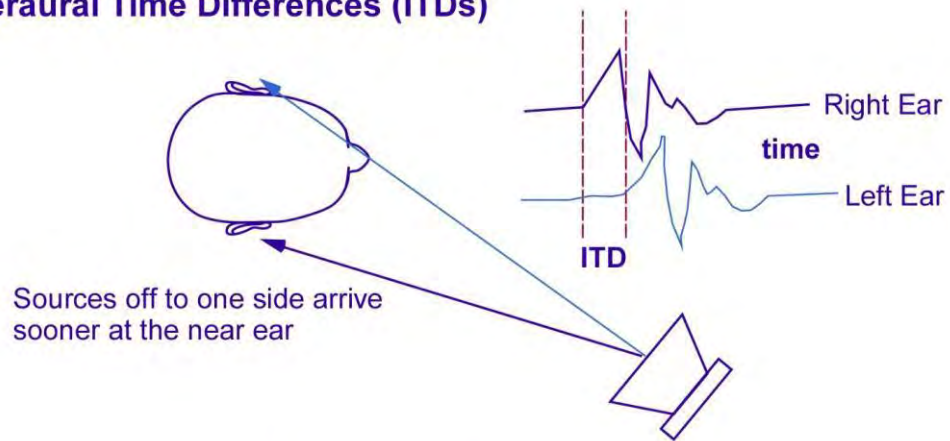
5.5.5.1 Primary Localization Cues

Auditory spatial perception refers to the ability to localize individual sound sources in 3D space even when multiple, simultaneous sources are present. Much of the research on human sound localization has derived from the classic “duplex theory,” which emphasizes the role of two primary cues (top two panels of Figure 5.5-10): interaural differences in time of arrival and interaural differences in intensity. Because the theory had been based primarily on experiments with single-frequency (sine wave) sounds, the original proposal was that interaural intensity differences resulting from head-shadowing determine localization at high frequencies, while interaural time differences were thought to be important only for

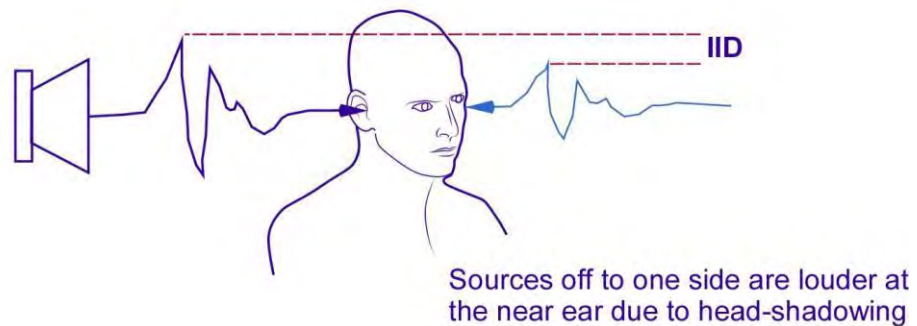
low frequencies because of the phase ambiguities occurring at frequencies greater than 1500 Hz. Binaural research over the last few decades, however, points to serious limitations of this approach. For example, it has become clear that interaural time differences in high-frequency sounds can be used if they have sufficient bandwidth within a critical band to produce relatively slow modulations in their envelopes.

The duplex theory also cannot account for the ability of subjects to localize sounds on the vertical median plane (directly in front of the listener), where interaural cues are minimal. Similarly, when subjects listen to stimuli over headphones, the sounds are perceived as being lateralized inside the head even though interaural temporal and intensity differences appropriate to an external source location are present. The results of many studies now suggest that these deficiencies of the duplex theory reflect the important contribution to localization of the direction-dependent filtering that occurs when incoming sound waves interact with the outer ears or pinnae and other body structures such as the shoulders and torso (bottom panel of Figure 5.5-10). As sound propagates from a source (e.g., a loudspeaker) to a listener's ears, reflection and refraction effects tend to alter the sound in subtle ways and the effect depends on frequency. For example, for a particular location, a group of high-frequency components centered at 8 kHz may be attenuated more than a different band of components centered at 6 kHz. Such frequency-dependent effects, or filtering, also vary greatly with the direction of the sound source. Thus, for a different source location, the band at 6 kHz may be more attenuated than the higher frequency band at 8 kHz. It is clear that listeners use these kinds of frequency-dependent effects to discriminate one location from another. Experiments have shown that spectral shaping by the pinnae is highly direction-dependent, that the absence of pinna cues degrades localization accuracy, and that pinna cues are primarily responsible for externalization or the "outside-the-head" sensation.

Interaural Time Differences (ITDs)



Interaural Intensity Differences (IIDs)



Spectral Shaping by the Pinnae (Outer Ear) Structures

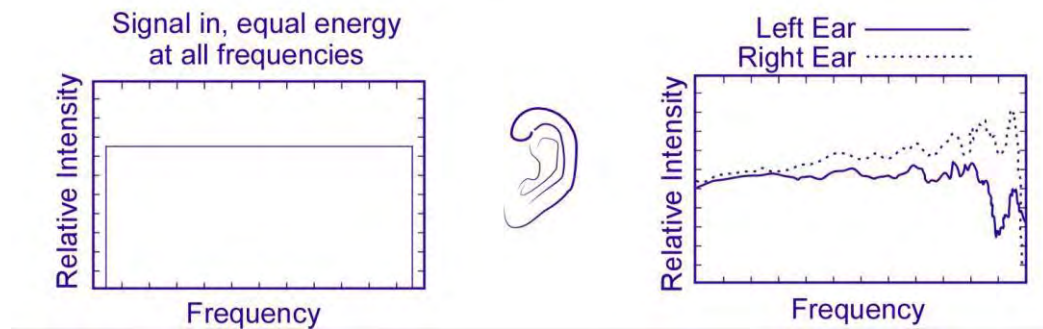


Figure 5.5-10. Primary localization cues.

5.5.5.2 Factors Affecting Localization Performance

In addition to the primary localization cues, the localizability of a sound also depends on other factors such as its spectral content: narrowband (pure) tones are generally difficult to localize while broadband, impulsive sounds are the easiest to locate. A closely related issue in the localizability of sound sources is their degree of familiarity. Logically, localization based on spatial cues other than the interaural cues, e.g., cues related to spectral shaping by the pinnae, is largely determined by a listener's a priori knowledge of the spectrum of the sound source. The listener must "know" what the spectrum of a sound

is to begin with to determine that the same sound at different positions has been differentially shaped by the effects of his or her ear structures. Thus, the perception of both elevation and relative distance, which depend heavily on the detection of spectral differences, tend to be superior for familiar signals like speech. Similarly, spectral familiarity can be established through training.

Several kinds of error are usually observed in perceptual studies of localization when subjects are asked to judge the position of a static sound source in the free field. One, which Blauert (1983) refers to as localization blur, is a relatively small error in resolution on the order of about 5° to 20° . A related measure of localization accuracy is the minimum audible angle (MAA), the minimum detectable angular difference between two successive sound sources. MAAs increase from about 1° for a sound straight ahead to 20° or more for a sound directly to the right or left. The minimum audible movement angle (MAMA) is the minimum detectable angular difference of a continuously moving sound source. The MAMA depends on the speed of the moving sound source and ranges from about 8° for a velocity of $90^\circ/\text{s}$ to about 21° for a velocity of $360^\circ/\text{s}$.

Another class of error observed in nearly all localization studies is the occurrence of front-back “reversals.” These are judgments that indicate that a source in the front hemisphere, usually near the median plane, was perceived by the listener as if it were in the rear hemisphere. Occasionally, back-to-front confusions are also found. Confusions in elevation, with up locations heard as down, and vice versa, have also been observed.

Although the reason for such reversals is not completely understood, they are probably due in large part to the static nature of the stimulus. In the absence of other cues, both front-back and up-down reversals would seem to be quite likely.

Several cues are thought to mitigate reversals. For example, presumably because of the orientation and shell-like structure of the pinnae, high frequencies tend to be more attenuated for sources in the rear than for sources in the front. For the case of static sounds, such cues would essentially be the only clues to disambiguating source location. With dynamic stimuli, however, the situation improves greatly. A variety of studies have shown that allowing listeners to move their heads substantially improves localization ability and can almost completely eliminate reversals. With head motion, the listener can apparently disambiguate front-back locations by tracking changes in the magnitude of the interaural cues over time.

Whether distance can be reliably judged is more problematic. It seems that humans are rather poor at judging the absolute distance of sound sources and relatively little is known about the factors that determine distance perception. Distance judgments depend at least partially on the relative intensities of sound sources, but the relationship is not a straightforward correspondence to the physical roll-off of intensity with distance (the inverse-square law). For example, as noted previously, distance judgment also depends heavily on factors like stimulus familiarity.

The addition of environmental effects can complicate the perception of location in other ways. Blauert (1983) reports that the spatial image of a sound source grows larger and increasingly diffuse with increasing distance in a reverberant environment, a phenomenon that may tend to interfere with the ability to judge the direction of the source. This problem may be mitigated by the phenomenon known as precedence. In precedence, or the “law of the first wave front,” the perceived location of a sound tends to be dominated by the direction of incidence of the original source even though later reflections could conceivably be interpreted as additional sources in different locations.

The impact of the precedence effect is reduced by factors that strengthen the role of the succeeding wave fronts. For example, in large enclosed spaces with highly reflective surfaces, reflections can occur that are both intense enough and delayed enough (i.e., echoes) to act as “new” sound sources, which can

confuse the apparent direction of the original source. Use of absorbent material on surfaces and walls can help mitigate such effects. Space environments are more likely to involve small enclosures with highly reflective surfaces and irregular shapes. The primary difference between small and large enclosures is that in a large room the statistical reverberant field dominates the sound field, while in a small room the sound field is dominated by resonant room modes. In fact, a reverberant sound field does not exist in a small room because the sound energy is not able to develop a diffuse, uniformly random distribution. Since no reverberant field exists in a small room, random placement of absorbing material will not improve the acoustic quality of the room. Instead, placement should coincide with resonant room modes, and consider reflected paths.

5.5.6 Auditory Perception of Complex Multidimensional Sounds

In the previous sections, aspects of auditory perception that may be thought of as primarily unidimensional have been discussed. For example, sounds can be ordered according to their loudness, or tones can be ordered according to their pitch from low to high. The relationship between this perceptual ordering is rather clearly linked to unidimensional physical sound parameters like sound intensity or frequency. In everyday listening, however, humans are routinely faced with much more complex sounds that typically vary in multiple dimensions of physical sound parameters. Furthermore, these complex sounds may arise from multiple sources and multiple locations and mix acoustically into a single, complex acoustic waveform. The task of the auditory system then is to interpret the incoming sound by identifying and parsing out the individual perceptual sound streams that correspond to the sound sources that contributed to the mixed sound. Thus, the auditory system performs an auditory scene analysis, perceptually grouping and organizing the incoming sound mixture into perceptual sources or streams, each with its own pitch, timbre, loudness, location, and identity.

Such complex, multidimensional sounds are often classified as either nonspeech or speech sounds since these types of sound seem to be processed differently by the auditory system. In particular, it seems that when we listen to speech stimuli, a special “speech mode” of perception occurs that is not engaged when we hear nonspeech sounds such as musical instruments, car alarms, or environmental sounds like animal noises or the wind in trees.

5.5.6.1 Nonspeech: Auditory Pattern and Object Perception

When sounds vary only in a single dimension, such as pitch, listeners are able to name and identify a particular sound only when the total number of sounds in the set is less than about 5 or 6 (Pollack, 1952).

For nonspeech sounds, the ability to identify a particular auditory object or sound source among a large number of possible sources is closely related to the ability to recognize the quality or timbre of sounds that vary in multiple dimensions of physical sound parameters. The American Standards Association (1960) defines timbre as “that attribute of auditory sensation in terms of which a listener can judge that two sounds similarly presented and having the same loudness and pitch are dissimilar.” Timbre differences, for example, allow one to distinguish between the same note played on a piano, a cello, or a flute. Timbre and object identification depend on a sound’s distribution of energy over frequency, or its magnitude spectra, as analyzed by critical band filters. Timbre also depends on a sound’s temporal patterning or variability over time; in particular, the presence of onset transients, the “shape” of the temporal envelope, and the repetitiveness or irregularity of the waveform over time.

Bregman’s (1990) research on auditory scene analysis distinguishes between an auditory source (the physical object that produces acoustic pressure waves) and the auditory stream (the percept of a group of successive and/or simultaneous sound elements as a coherent entity that seems to be from a single

source). Thus, the distinction is between the violin being played and the percept of hearing a violin. When faced with a whole orchestra, the auditory system somehow interprets the incoming sound by identifying and parsing out the individual perceptual sound streams that correspond to the individual instruments that contributed to the complex mix of acoustic waveforms.

The auditory system uses a number of physical acoustic cues to perceptually separate the components arising from different sound sources. These include

- Differences in fundamental frequency
- Disparities in onset time
- Spectral differences compared to preceding sounds
- Changes in frequency and intensity
- Differences in sound source location

Each difference cue on its own is not always a reliable indicator of source separation, but in combination they provide a good basis for parsing an acoustic input into the appropriate sound streams.

Rapid sequences of sounds may be heard as a single sound stream or they may segregate into a number of perceptually distinct sound streams. Perceptual segregation is more likely to occur when components making up the sequence of sounds differ greatly in frequency, amplitude, location, or spectrum, as would normally be the case for different physical sound sources. When elements of a sound are perceptually grouped into two different streams, it is more difficult to judge their temporal order than if they are heard as part of a single stream. For example, if several high- and low-pitched tone bursts are rapidly mixed with each other, they will be heard as two separate sounds, one composed of the low pitches and one composed of the high pitches. Listeners may be able to discriminate the order of the low pitches relative to each other, or the high pitches relative to each other, but not the relative order of the low and high pitches that have been “assigned” to different sound streams.

Principles of perceptual organization that have been described by Gestalt psychology also apply well to the organization of the auditory world. These principles include

- *Similarity*. Sounds will be grouped into a single stream if they are similar in pitch, timbre, loudness, or subjective location.
- *Good Continuation*. Smooth changes in frequency, intensity, location, or spectrum will be perceived as changes in a single source, while abrupt changes will be perceived as a new or different source.
- *Common Fate*. If two components of a sound undergo a similar change at the same time, they will be perceived as part of a single source. This applies particularly to amplitude modulation and to onset and offset times (asynchronies greater than about 30 s are perceived as segregated sound streams).
- *Disjoint Allocation or “Belongingness.”* A single component in a sound can be assigned to only one sound stream at a time.
- *Closure or the “Continuity Effect.”* When parts of a sound are masked, the sound will be perceived as continuous as long as there are no direct acoustic cues that it has been interrupted. For example, when a tone with an upward glide in frequency is alternated with noise bursts, the upward glide is perceived as continuous even though parts of the glide are physically missing.

Attention may also play a role in perceptual organization, as in the figure-ground phenomenon.

Attention can be focused on only one sound stream at a time, and that stream is perceived as standing out from a background of other sound streams. Attentional focus may be constrained by the formation of sound streams; it is difficult to pay attention to and make relative judgments about components in two

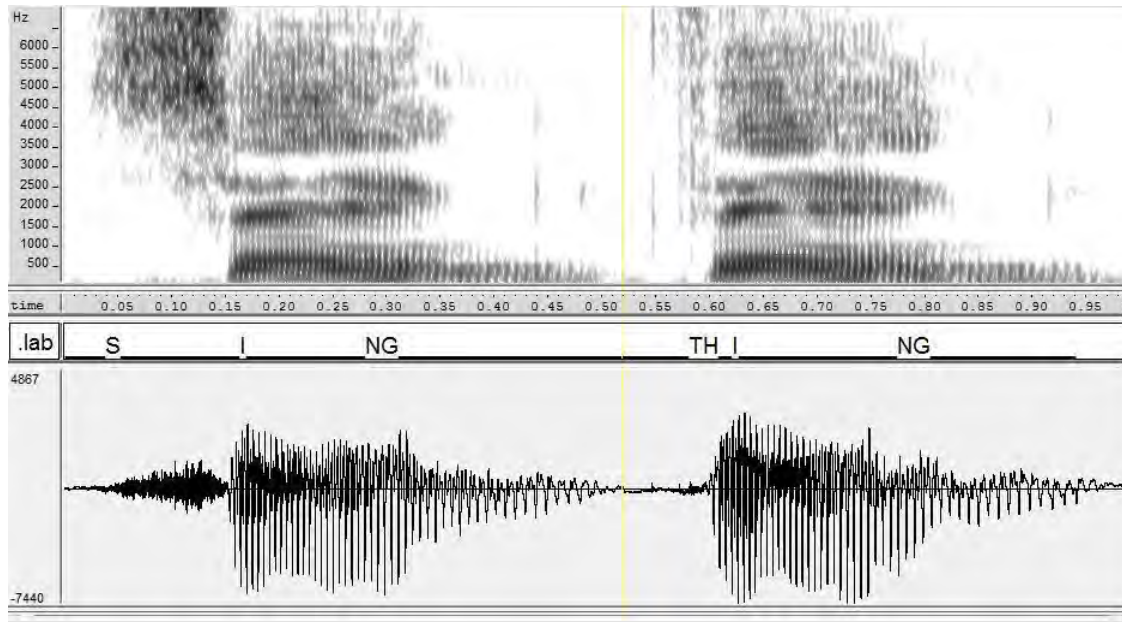
different streams. Attentional focus may also influence stream formation. For example, when the frequency difference between alternating tones is not large enough to clearly signal different sound streams (about 7 semitones), the tones can be heard as either one or two streams, depending on the listener's attentional focus.

5.5.6.2 Speech

Like complex nonspeech sounds, speech is a multidimensional stimulus that varies in a complex way in both frequency and time. Speech may be represented as a time-varying waveform (Figure 5.5-11, top panel), or as a static spectrum plot of the magnitude of frequency components (Figure 5.5-11, middle panel), but the representation of speech that is most consistent with the way the auditory system analyzes speech is the spectrogram (Figure 5.5-11, bottom panel). The spectrogram simultaneously plots the dimensions of intensity, frequency, and time. Speech sounds contain energy throughout the audible range, but most of the energy corresponding to speech phonemes is concentrated below 8000 Hz. Phonemes are a categorical classification system that reflects the basic set of sounds that make up the building blocks of a language. American English, for example, has about 41 phonemes. From the spectrogram, one can see the relative spectral content of the different phonemes. Note that fricative phonemes like “f” and plosive phonemes like “t” have considerable energy in the higher frequency range from 4000 to 8000 Hz.

From a practical communications standpoint, communication systems must be designed to transmit frequencies up to about 7000 to 8000 Hz. Otherwise, listeners may have difficulty distinguishing between sounds like “t” and “s.” While communication is clearly possible with standard telephone speech that cuts off at 3500 Hz, there is a greater likelihood that miscommunications and requests for repetition will occur and that speech quality will suffer. The 3500-Hz cutoff for telephone speech was necessitated by technological limitations at the time analog telephone systems were being designed. Modern communication systems, especially those being designed for special applications like the space environment, do not need to conform to this limitation. For example, modern digital voice codecs readily provide bandwidths of 7000 Hz with high quality (e.g., the International Telecommunication Union standard G.711.1). Even greater bandwidth and audio quality can be achieved by using audio codecs designed for entertainment systems. See section 6.6.2.2 of HIDH chapter 6.6, “Acoustics,” and 10.7, “Audio Displays,” for a further discussion of speech communication issues.

Many of the perceptual organizational principles discussed above for nonspeech sounds also apply to speech stimuli. For example, as in the continuity effect, segments of a spoken sentence interrupted by short noise bursts will be heard as continuous speech in a background of noise. If the noise is replaced by silence, the interrupted speech will sound distorted and much less intelligible, presumably because the abrupt onsets and offsets provide misleading cues about which speech sounds or phonemes are present. The phenomenon also points to the special nature of continuous speech perception. While phonemes provide a convenient framework for describing speech sounds, it is difficult to find the cues in the acoustic waveform that unambiguously identify a phoneme in both isolation and continuous speech. For a phoneme to be correctly identified, it may need to be heard as part of a whole syllable or even a group of words.



The figure shows the methods typically used for representing speech sounds, here applied to the words “sing” and “thing” spoken successively by a male speaker. The bottom panel shows a waveform display of these two words, representing the variation in sound pressure (ordinate) over time (abscissa). The upper panel shows the sound spectrogram of the two words at the equivalent moment in time, with frequency plotted on the ordinate and with the relative darkness of the plot indicating magnitude. The horizontal bands of energy correspond to the vocal resonances, or formants, of the voiced portion of the words. The less-defined dark “blotches” correspond to the unvoiced “s” and “th” at the onset of the words, which are less spectrally defined (noisy). Note that the waveform and spectral representations are very similar; the two words are primarily distinguished by their onsets.

Figure 5.5-11. Representation of speech sounds.

Evidence exists that speech is a special type of auditory stimulus that is perceived and processed differently from nonspeech sounds. For example, studies of cerebral asymmetry show that certain parts of the brain are specialized for processing speech while other parts process nonspeech or musical sounds. Also, unlike nonspeech sounds, speech sounds demonstrate categorical perception: small changes in the acoustic signal may be perceived as a change in the identity of the syllable as opposed to a small incremental change in a single dimension like frequency. Speech perception also demonstrates audiovisual integration; identification of speech sounds is influenced by what is seen on the face of the speaker. It is clear that speech is a highly redundant and complex signal that is processed at many levels of the brain. As such, it is remarkably resistant to many types of distortion including background noise, band-limiting, and peak-clipping. Distortion may destroy some cues in the speech waveform, but other cues are often sufficient to convey meaning. However, even if intelligibility remains relatively high, distortions of the speech signal will increase listening effort and fatigue, and reduce speech quality to the point where communication becomes difficult and annoying. The design of modern communication systems should not simply rely on the remarkably forgiving nature of the human auditory system.

5.5.7 Research Needs

- Characterization of space environment acoustics – To appropriately design and implement effective acoustic displays and communications systems, the acoustical parameters of all crew-rated environments – e.g., vehicles, habitats, spacesuits – should be measured and considered early in the design process. If necessary, mitigation strategies should be employed to optimize acoustical characteristics for human audition.

- Perceptual impact of space environments – Very few data are available on the impact of such factors as non-Earth atmospheric pressures and breathable gas mixtures on human perception of auditory signals, including speech communications. Systematic and objective assessment of such factors during both short- and long-term missions is needed to assure effective auditory information transfer and maximize crew hearing health.
- Crewmember hearing sensitivity should be periodically monitored – Sensorineural hearing loss, including NIHL, should be identified early and mitigation strategies should be developed, if necessary. Prevention of hearing loss is of particular importance to NASA, since astronauts and pilots are often exposed to high levels of noise in training and during missions that can both temporarily and permanently affect their hearing sensitivity.

5.6 COGNITION

5.6.1 Introduction

Space missions require that crewmembers have knowledge of the spacecraft hardware and software, the ability to acquire new knowledge about the environment, the ability to remember the information, and the ability to reason in novel situations. These abilities, to obtain, use and maintain knowledge, are referred to as cognition.

The purpose of this section is to provide

- A summary of what is currently known about changes in cognition during space flight
- A concise overview of mission-relevant human cognitive abilities
- Recommendations toward human factors design considerations related to human cognitive capabilities
- A review of current performance tests used to assess astronaut cognitive performance
- A discussion of additional cognitive tests that may augment our understanding of cognitive changes during extended space flights

5.6.2 General Cognition

The role of the astronauts' cognitive abilities increases as their autonomy increases. On longer space missions, astronauts will have to perform well with less training (e.g., under unanticipated circumstances requiring improvisation). The interaction of astronauts with computers and automated systems emphasizes perceiving, attending, thinking, decision-making, and problem-solving (Rasmussen et al., 1994; Sheridan, 2002). To design these types of work systems effectively, designers must apply knowledge of human information-processing capabilities to the design process.

With increasing autonomy required for long-duration missions beyond low Earth orbit, it is imperative that designers have an approximate, intuitive feel for human memory and problem-solving processes that will serve as a context for use in interpreting guidelines, in making design choices in the absence of guidelines, and in communicating with others on the development team.

Space exploration draws heavily on an astronaut's cognitive functions. Computers excel at rapid and repetitive calculations, but today's software and hardware are limited by the current knowledge and imagination of mission planners and designers. It is impossible to anticipate unexpected events. Humans are a critical subsystem in space exploration because they possess the ability for spontaneous observation and the integration and interpretation of dynamic situations as a whole. For example, during the second of three EVAs outside of the Challenger Lunar Lander on the Apollo 17 mission, Jack Schmitt's expertise in geology led to the discovery of a chemically unusual material known as orange soil.

Space flight is a new experience for each astronaut who flies. Given that the brain shows plasticity (i.e., the ability to reorganize neural pathways based on new experiences), it is not surprising that 0g influences the brain. It is not known, however, how cognitive processes will change with very long-duration space travel.

5.6.3 Human Cognitive Abilities

Cognition includes the mental processes of attention, memory, reasoning, decision-making, judgment, and problem-solving. Figure 5.6-1 shows the flow of human cognitive processes according to an information-processing approach. This approach uses the computer as an analog. Computers accept incoming information, store that information for further use, and use it later for computation in solving problems. Likewise, people take information in the form of physical energy from the environment (stimuli), and this physical energy is transformed into chemical energy and then into electrical energy in the course of transmission from the sense organs to the brain. Stored information can later be retrieved, used to solve a problem, and then expressed as output (responses).

Of course the brain processes are much more complex than those of any existing computer. For example, computers do not have the ability to perform certain cognitive functions, including understanding (Dreyfus, 1979), and the model is not useful when trying to understand some questions of interest, such as consciousness. But the information-processing approach can provide a general way to discuss human cognitive functioning.

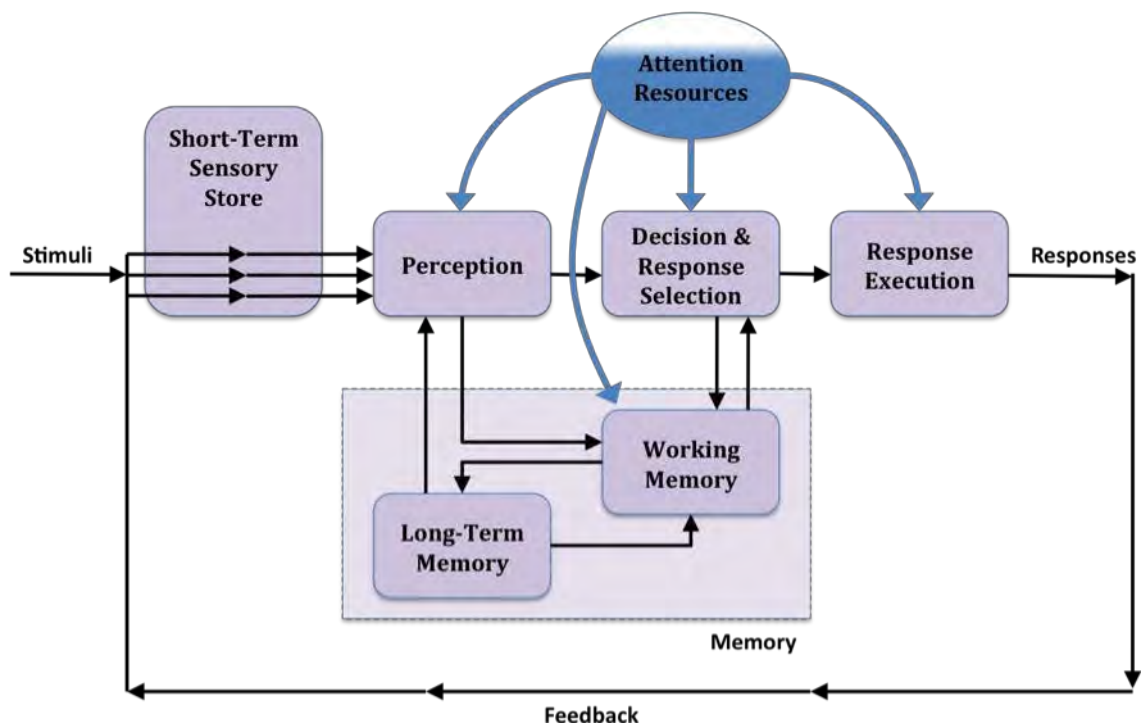


Figure 5.6-1. Model of information processing (adapted from Wickens, 1992).

More recently, the parallel-distributed processing model has driven cognitive research (e.g., McClelland & Rumelhart, 1986). This model of pattern recognition is based on the activity of the brain. All processes in the brain are assumed to interact with one another in parallel, and knowledge is thought to reside in the connections and patterns of activation among neural units. Perception, attention, emotion, planning and action, learning and memory, thinking, language, and all other aspects of cognition take place in the brain. Complex cognitive functions arise from the coordinated action of many parts of the brain, in much the same way that a piece of music may reflect the coordinated action of many musicians within an ensemble.

The brain shows plasticity. Any attempt to measure brain processes in and of itself can alter the brain. Evolving in this solar system, on the planet Earth, has determined how we think and what we know. It is known that the communications between some neurons are affected by 0g. It is not known how

cognitive processes will change with very long-duration space travel. We do have some indications of changes that occur on trips of shorter duration. These will be discussed in the following sections.

5.6.3.1 Reaction Time

Reaction time and accuracy are typical dependent variables used in experimental cognitive psychology. Processing speed has a major impact on higher-level cognitive abilities and is extremely vulnerable to neurological insult. Simple reaction time (e.g., is a stimulus present or absent) is shorter than a recognition reaction time (e.g., has the stimulus been presented before), which is shorter than a choice reaction time (e.g., identify which of multiple presented stimuli has been presented before). Miller and Low (2001) determined that the time for motor preparation, such as tensing muscles, and motor response (in this case, pressing a spacebar) was the same in all three types of reaction time test, implying that the differences in reaction time are due to cognitive processing time.

For about 120 years, the accepted figures for mean simple reaction times for college-age individuals have been about 190 ms (0.19 s) for light stimuli and about 160 ms for sound stimuli (Galton, 1899; Fieandt et al., 1956; Welford, 1980; Brebner & Welford, 1980). Auditory reaction times may be quicker than vision reaction times because an auditory stimulus takes only 8 to 10 ms to reach the brain (Kemp, 1973), but a visual stimulus takes 20 to 40 ms (Marshall et al., 1943). Reaction time to touch is intermediate, at 155 ms (Robinson, 1934). Differences in reaction time between these types of stimuli persist whether the subject is asked to make a simple or a complex response (Sanders, 1998).

Reaction time estimates have been shown to be sensitive to a variety of variables. For example, Hick (1952) found that in choice reaction time experiments, response was proportional to $\log(N)$, where N is the number of different possible stimuli. This relationship is called “Hick’s Law.” Sternberg (1969) maintained that in recognition experiments, as the number of items in the memory set increases, the reaction time rises proportionately (that is, proportional to N , not to $\log N$), increasing by about 40 ms every time another item was added to the memory set. Table 5.6-1 lists other variables that can affect reaction time estimates.

Table 5.6-1 Effects of Variables on Reaction Times

Effects of Variables on Reaction Times
Become more stable with practice (Sanders, 1998)
Get faster with practice (Ando et al., 2002) (up to 3 weeks of practice)
Get slower with eccentric viewing (Brebner & Welford, 1980)
Are fastest with an intermediate level of arousal (Broadbent, 1971; Freeman, 1933; Welford, 1980) Exercise improves reaction time by increasing arousal (Davranche et al., 2006).
Get slower with increased fatigue (Welford, 1980) Takahashi et al. (2004) studied workers who were allowed to take a short nap on the job, and found that although the workers thought the nap had improved their alertness, there was no effect on choice reaction time.
Are unaffected by 3 days of fasting, but fasting did impair capacity to do work (Gutierrez et al., 2001)
Get slower with distractions (Broadbent, 1971; Welford, 1980) Trimmel and Poelzl (2006) found that background noise lengthened reaction time by inhibiting parts of the brain's cerebral cortex. Richard et al. (2002) and Lee et al. (2001) found that college students given a simulated driving task had longer reaction times when given a simultaneous auditory task. They drew conclusions about the safety effects of driving while using a cellular phone or voice-based e-mail.
Get faster when the person is alerted that the stimulus will arrive soon (Brebner & Welford, 1980)
Are slower when the person has to react to different types of stimuli in mixed order (e.g., a shift in attention; Hsieh, 2002)
Are faster when the person is anxious (Panayiotou & Vrana, 2004) Verlasting (2006) found that deployment to Iraq caused soldiers to have shorter reaction times, but it also increased tension and reduced proficiency at tasks requiring memory and attention.
Are faster with moderate doses of caffeine (Lorist & Snel, 1997; McLellan et al., 2005)
Are slower with brain injury (Bashore & Ridderinkhof, 2002) Collins et al. (2003) found that high-school athletes with concussions and headache a week after injury had worse performance on reaction time and memory tests than athletes with concussions but no headache a week after injury.
Are slower with minor respiratory tract infections (Smith et al., 2004) Minor respiratory tract infections also cause disturbances of sleep.

5.6.3.2 Short-Term Sensory Register

All information about the environment enters through the sense organs of the eye, ear, nose, tongue, and skin. Specialized receptor cells contained in each of these organs respond to physical energy from the environment. Information received by the receptor cells is temporarily stored in a memory system referred to as the short-term sensory register. The function of this brief-storage bin is to maintain sensory information until we are capable of interpreting or adding meaning to it. This helps people avoid losing present information while they are processing information that has just occurred.

The receptors are continually receiving information, so the sensory register has to be cleared quickly to avoid superimposing information from two exposures. For vision and audition, the duration of the registers has been extensively studied, and has the following values:

- Vision... 300 ms (Sperling, 1960)
- Audition.....20 s (Watkins & Watkins, 1980)

The auditory sensory register's trace lasts longer than does the visual sensory register's trace because their requirements differ. Vision simultaneously takes in a lot of information spatially, whereas audition requires integration over time. For example, to understand a spoken sentence, a person has to remember the first part of the sentence while the second part is being uttered.

Masking, or an erasure, of the information in the sensory register can occur if, for example, another object is immediately presented in the location of important information. Therefore, if the intent is for the astronaut to process simplistic information on a visual screen, the designer must permit at least 300 ms before replacing that information with something else. The 300-ms presentation length assumes that the astronaut was attending to that information at the start of the presentation. Similarly, masking of the end of a list of verbal instructions can occur if additional information is immediately provided.

Display designers should be aware of a phenomenon known as "change blindness," in which a person viewing a visual scene fails to detect large changes in the scene (Rensink et al., 1997). For change blindness to occur, the change in the scene typically has to coincide with some visual disruption such as a saccade (eye movement), a display being turned off even as briefly as 67 ms (Pashler, 1988), or a brief obscuration of the observed scene or image. When a subject is looking at still images, change blindness can be achieved by changing a part of the image within 13 seconds or longer. Change blindness can occur due to a failure to comprehend or store the information in the first place thus, visual short-term register models may be important for understanding the phenomenon). Therefore, designers should not assume that, just because one feature on a complex display has changed, this change will be immediately noticed by the astronaut.

5.6.3.3 Attention

Not all the information reaching the sensory register can be processed in pattern recognition. Attention is the cognitive process of selectively concentrating on one aspect of the environment while ignoring other things. Research has shown that when an object or area is attended, processing operates more efficiently (Gazzaniga et al., 2002; Posner, 1980). Five types of attentional processes have been identified (Figure 5.6-2).

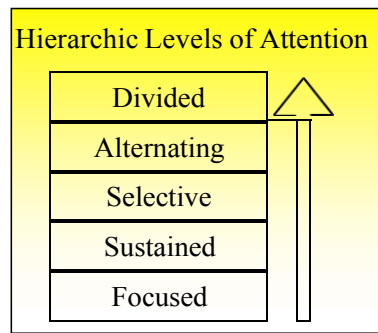


Figure 5.6-2. Hierarchical levels of attention.

This model of attention is based on the recovering of attention processes in patients coming out of coma (Sohlberg & Mateer, 1989):

- 1) Focused attention is the ability to respond discretely to specific visual, auditory, or tactile stimuli.
- 2) Sustained attention refers to the ability to maintain a consistent behavioral response during continuous and repetitive activity. Among other activities, EVAs require intense sustained attention.

The continuous performance test (CPT) is a widely used procedure for measurement of sustained attention or vigilance (Mass et al., 2000). A variety of CPTs exist, the more commonly used being the Conner's CPT-II and the Test of Variables of Attention. These attention tests are often used as part of a battery of tests to understand a person's "executive functioning" or their capacity to sort and manage information.

Although the tests may vary in terms of length and type of stimulus used, the basic nature of the tests remains the same. A series of numbers, symbols, sounds, or letters are presented on a screen. The task is to click a button (or computer mouse) whenever the "target" stimulus is seen, for instance the letter "X." The letter frequency may be manipulated to favor different types of errors (i.e., errors of omission versus commission). To increase the difficulty, some tests change the task so that the person clicks only if they see the letter "A" before the letter "X" (Conners & Staff, 2000).

3) Selective attention refers to the capacity to maintain a behavioral or cognitive set in the face of distracting or competing stimuli. Therefore it incorporates the notion of "freedom from distractibility." The "cocktail party" effect describes the ability to focus auditory attention on a single talker among a mixture of conversations and background noises, ignoring other conversations (Cherry, 1953). The effect can occur when we are paying attention to one of the sounds around us or when a stimulus suddenly grabs our attention. Much of the early work in this area can be traced to problems faced by air traffic controllers in the early 1950s. At that time, controllers received messages from pilots over loudspeakers in the control tower. Hearing the intermixed voices of many pilots over a single loudspeaker made the controller's task very difficult. Recent work on spatially separating multiple auditory inputs is promising (Begault, 2004). Design can augment the attended message with further critical information within the same channel. Providing that information within a different channel (e.g., visually) can overload the person's cognitive capacity.

The human attentional system is superb at homing in on areas of importance. People use cognitive schemas, or mental models, to guide their attentional focus. In design, an effective way to grab the user's selective attention is to adhere to the user's mental model of what is expected. To make an item salient, follow conventions. An example of how things can be overlooked when the user's mental model is not adhered to is seen by "banner blindness." Banner blindness refers to the finding that people tend to ignore the flashy, colorful banners at the top of web pages.

4) Alternating attention refers to the capacity for mental flexibility that allows individuals to shift their focus of attention and move between tasks having different cognitive requirements. The environment around us is full of objects, features, and scenes that compete for our attention. Unfortunately, the human mind is limited in its ability to process information, and simultaneous processing cannot occur without a cost (Gazzaniga et al., 2002). Therefore, shifting of attention is necessary because it allows us to redirect attention to environmental aspects we want to focus on, and subsequently process. These shifts of attention can help facilitate the processing of multiple stimuli. An astronaut's duties are goal directed and require an adaptive cognitive control system for selecting relevant information, organizing and optimizing the processing of the information. Astronauts continuously assess their ongoing actions and the outcomes of these actions so that they may adjust their behavior to optimize the situation.

Changes in spatial attention can occur with the eyes moving, overtly, or with the eyes remaining fixated, covertly (Wright & Ward, 2008). Before an overt eye movement occurs, when the eyes move to a target location, covert attention shifts to this location (Deubel & Schneider, 1996; Hoffman & Subramaniam, 1995; Kowler et al., 1995; Peterson, Kramer, & Irwin, 2004). However, it is important to keep in mind that attention is also able to shift covertly to objects, locations, or even thoughts while the eyes remain fixated. For example, a person may be driving and keeping their eyes on the road, but then, even though their eyes don't move, their attention shifts from the road to thinking about what they need to get at the grocery store. The eyes may remain focused on the previous object attended to, yet attention has shifted (Hoffman, 1998).

5) Divided attention is the highest level of attention and it refers to the ability to respond simultaneously to multiple tasks or multiple task demands.

Factors that affect attention include

- *Sleep Deprivation* - Attentional focus requires effort and is significantly affected by sleep deprivation.
- *Sedatives* – Some drugs, including some motion sickness medications, decrease vigilance even in the absence of sleepiness. Lessons learned in transportation safety show that tests of vigilance (i.e., tests of sustained attention) seem to be the most sensitive measures for detecting the sedation effects that may contribute to accidents.

System design can aid in the selection and organization of relevant information to reduce the level of cognitive effort required to attend to a stimulus in the environment:

- Information should be prioritized so that the most important or critical information is displayed all the time and less important or critical information can be displayed upon a user's request (Avery & Bowser, 1992).
- The system should differentiate items of information. It should call a user's attention to important information, unusual situations, or potential problems that require user action; or indicate changes in the state of a system by highlighting, inverse video, color-coding, or other means (Department of the Navy, 1992; Smith & Mosier, 1986).
- When users are required to monitor multiple displays, important events should occur in all of the displays to promote effective monitoring performance (Warm et al., 1996).
- Coding techniques that have strong attention-getting qualities (for example, color and flashing) should be used sparingly and judiciously (National Air Traffic Services, 1999).

5.6.3.4 Working Memory

How humans store, retrieve, and use information is still poorly understood. Active theories form a continuum ranging from two separate memory systems that communicate and coordinate the information (e.g., Baddeley & Hitch, 1974) to a single memory system with embedded elements. Regardless of which model guides the research, we do know many things about human memory. In this discussion, the view is taken that working memory and long-term memory are separate but coordinated systems.

The transfer of information from the sensory register to working memory is controlled by attention. Working memory refers to the process of temporarily storing and manipulating information over a time span of several seconds. Other terms used (somewhat) interchangeably with working memory include short-term memory, primary memory, and immediate memory.

Working memory has a limited capacity. Early research estimated the number of working memory chunks to be from five to nine in adults (Miller, 1956). More recent research estimates that number to be about four in young adults (Cowan, 2001). This means that a user can actively cope with only a limited number of chunks of information at any given time, and designers need to take account of this fact.

How then can we understand the complex relations between thoughts expressed in a novel or a scientific text? Ericsson and Kintsch (1995) have suggested that people store most of what is read in long-term memory, linking it together through retrieval structures. We need to hold only a few concepts in working memory, which serve as cues to retrieve everything associated with them by the retrieval structures.

Representations in working memory decay unless they are refreshed through an attentional process. Attention is also needed for any concurrent processing task. When small time intervals exist in which the concurrent processing task does not require attention, this time can be used to refresh memory traces. The task's cognitive load depends on three variables: the difficulty of the information-processing steps, the rate at which the processing task requires individual steps to be carried out, and the duration of each step. For example, if the processing task consists of adding digits, then having to add another digit every half second places a higher cognitive load on the system than having to add another digit every 2 seconds. Adding larger digits takes more time than adding smaller digits, and therefore cognitive load is higher when larger digits are added. A substantial body of research suggests that the degree of task similarity (e.g., two concurrent visual tasks), response similarity (e.g., verbal response on both tasks), and processing stage similarity (e.g., working memory and response) is of great importance in determining the impact of task load on performance.

Working memory capacity can be tested by a variety of tasks. A commonly used measure is a dual-task paradigm combining a memory span measure with a concurrent processing task. For example, Daneman and Carpenter (1980) used "reading span." Subjects read a number of sentences (usually two to six) and try to remember the last word of each sentence. At the end of the list of sentences, the subjects repeat back the words in their correct order. Other tasks that do not have this dual-task nature have also been shown to be good measures of working memory capacity. The question of what features a task must have to qualify as a good measure of working memory capacity is a topic of ongoing research.

The topic of dual-task performance is particularly relevant for flight operations, because astronauts are routinely given very high task loads. During an 8-day space mission, one astronaut's dual-task performance (unstable tracking with concurrent memory search) showed a decline over the course of 13 measurements (Manzey et al. 1995). Because astronauts are exposed to multiple stressors, it is not clear which stressors were associated with the decline.

In real life, memory skills must be compatible with interruptions and many other concurrent activities that demand attention. Working memory processes are highly susceptible to interruptions and distractions because information in working memory has to be actively maintained or rehearsed (e.g., repeating a phone number to yourself until you have dialed it). Once this active rehearsal process stops, information in working memory is generally not retrievable. Maintaining information in working memory is an effortful process that requires concentration and mental energy – energy that is then unavailable for other cognitive processing. Information stored in long-term memory is more robust, but retrieval of information can be disrupted by stress, the passage of time, and the normal aging process. Well-learned or -trained information in long-term memory is less susceptible, but not impervious, to forgetting.

5.6.3.5 Long-Term Memory

Once information is in working memory, rehearsal can transfer it into long-term memory. Long-term memory is the heart of human intellectual functioning. It is more than a storage bin of information. It is a dynamic function that guides activities and decisions. Memory is important not only because it is a repository of the past, but also because it serves as an important basis for making plans for the future, plans that are essential to guiding our behavior. Memory assists in our world perception and is an indispensable tool in reasoning and solving daily problems.

Information stored in human memory is not static but rather “reconstructive,” in that recollections are constructed on the fly based on an amalgam of past events (Bartlett, 1932; Reyna & Brainerd, 1995). Unlike data stored in a book or on a computer, in human memory systems new recollections of a past event or information can be influenced by experiences, states of knowledge, beliefs, and feelings that happened after the information was stored—imagine returning to a book that has been on a library shelf for some time, only to find that words and passages from neighboring books were merging into the text. If the neighboring books were on similar topics, it might be very difficult to discern which words were from the original text and which were from neighboring texts. For this reason, human memory is susceptible to misattribution (attributing memories to incorrect sources, such as neighboring books, to continue the library metaphor), or believing that you have seen or heard something you have not.

Humans encode only that information about an event that seems relevant at the time the event takes place, although the memory of the event can be changed if it is thought about in the future. Although this may seem like a shortcoming, it is this process that allows humans to deal with the multitude and complexity of information in the environment without becoming overloaded (Cohen, 1996).

Long-term memory processes are used to remember to perform tasks that we intend to perform in the future (e.g., going to a meeting next Tuesday). This is referred to as *prospective* memory, as opposed to *retrospective* memory, which refers to memory for past events. Prospective memory tasks are subject to forgetting when there are no noticeable or conspicuous reminders in the environment that indicate what task needs to be performed and when it needs to be performed. Ideally, according to Einstein and McDaniel (2004), a good reminder will have the following characteristics:

- The reminder will be highly noticeable or attention-grabbing,
- The reminder will have features that bring the desired intention to mind (i.e., a flashing red light might get a user’s attention, but it is not a good reminder if the user does not remember what to do in response to that light), and
- The reminder is noticed at an appropriate time for the user to perform the intended action (i.e., if the reminder is presented too early, the user is susceptible to forgetting to perform the intended action at a later time).

Some tasks are or can become automatic, having no detectible cognitive capacity requirements, leaving resources for other tasks (Logan, 1985; Shiffrin & Schneider, 1977). Studies can determine if a task has been learned to the point of automaticity. The “secondary task method” involves measuring the amount of interference between two tasks. If a certain task can be performed as well with another task as it can alone, that task is assumed to require no capacity. Automaticity is important for normal functioning in everyday tasks. Reading, for example, requires rapid access to the meaning of verbal units such as words, sentences and paragraphs. Yet reading presumably begins with letter recognition. If recognition of each letter required much effort, reading would be painfully slow (as it is for first-graders). Not only is letter recognition automatic, but also access to word meaning seems to occur with little effort.

The following are factors and recommendations to help the astronaut’s working and long-term memory:

- *Codes* – Categories of data should be coded if a user is required to distinguish the data included in the categories rapidly and if the data items are distributed in an irregular way on the display (Department of Defense [DOD], 1989 MIL-HDBK-761A). Codes should be meaningful and consistent, and should be used only for functional, not decorative, purposes (DOD, 1989 MIL-HDBK-761A; National Air Traffic Services, 1999). For example, male and female might be coded **M** and **F** rather than 1 and 2. Codes that are assigned a special meaning in a display should be defined at the bottom of the display.
- *Suppressed Information* – When the display of information is temporarily suppressed, an indication of this suppression should be provided on the display. The user should be notified of any significant changes in suppressed information, and should be able to restore suppressed data quickly to the originally displayed form. The system should provide a quick and easy means for restoring suppressed information. The user should be permitted to suppress displayed data not required for the task at hand (CTA, 1996; DOD, 1989 MIL-HDBK-761A).
- *Help System* – When users are in an unfamiliar situation without a clear sense of what is going on, they can and do detect ambiguities that might remain unnoticed by designers. A person who is uncertain about how to proceed with a particular problem can be aided by a task-specific mini-help system that is coaching him or her through the task and constrains choices to those appropriate for task completion.
- *Purpose* – Humans remember information such as steps in a procedure better if they have a clear understanding of the overall goal or purpose of the procedure. Memory performance will be improved by the extent to which users understand *why* they are performing tasks or procedures (and the logic behind why steps are performed in a certain order – i.e., why *b* logically follows *a*, etc.).
- *Knowledge Structures* – In considering the nature of human memory and the processes involved in storage, retention, and retrieval of information, it is clear that humans interacting with computers can and do use existing memories and memory structures to assign a meaning or interpretation to a wide variety of things, regardless of whether that meaning was the one intended by the designers. Consequently, system designers should understand and take account of existing knowledge structures and how people think about domain problems and the problems of interaction.
- *Cues* – Providing appropriate cues tied to the user’s existing knowledge structures in the interface and the flow of interaction can reduce the demands on human learning and memory (Cohen, 1996). Well-learned and meaningful information is more easily retrieved from memory; therefore cues and symbology that relate to the user’s existing knowledge or experience will increase retrieval success. Note that display conventions used among designers are not necessarily the same as those prevalent with the target user community; it is the user’s knowledge structures that should inform design decisions.

- *Information Access* – Procedures and displays should be designed to provide users with access to all of the information needed to perform a task without having to refer to additional information accessible only through memory. Exception: Tasks that require *very rapid* responses may be performed via “memory items,” but procedures performed from memory should be backed up with written procedures as soon as it is practical to do so.
- *Reminders* – Because humans display lapses of attention and forgetting to perform tasks, procedures and displays should provide users with cues that remind them to perform tasks at the right time (Einstein & McDaniel, 2004). These cues have the following characteristics:
 - Highly noticeable or attention-grabbing
 - Features that bring the desired intention to mind
 - Being noticed at an appropriate time for the user to perform the intended action
- *Immediate Tasks* – Procedures should be developed to minimize deferred tasks. Whenever possible, procedures should instruct users to perform tasks immediately rather than in response to a future event. The best countermeasure for reducing prospective memory errors is to avoid creating situations that require deferring intentions (Einstein & McDaniel, 2004). Immediate performance of a necessary action eliminates the risk of forgetting to perform the action. Although this is an effective solution, it may not be possible or practical to implement in all situations.
- *Task State* – Displays and interfaces should provide clear indications of the state of a given task (i.e., whether a task has been performed, and/or indication of the current progress or step in a complex procedure or checklist). Although repetition and practice protect against many types of memory failures, “routine” tasks that are performed with minimal cognitive effort are susceptible to a different type of memory failure: forgetting whether or not that task has already been performed (Johnson, Hashtroudi, & Lindsay, 1993). Highly trained experts, who may perform complex well-learned tasks with little cognitive effort, can be particularly susceptible to this type of memory failure precisely *because* they are experts.
- *Stress* – High levels of stress or anxiety can impair working memory function as well as recall of information from memory. Procedures and displays designed to be used during highly stressful situations (e.g., emergency procedures) should assume degraded memory performance. Research suggests that, under stress, tasks that involve working memory processes such as performing mental calculations or mentally visualizing a spatial layout are impaired. Long-term memory performance shows a pattern similar to attentional “narrowing” under stress, in which retrieval of information in long-term memory is restricted to habits that are well-learned or overlearned (Driskell, Willis, & Cooper, 1992). Thus, in some instances, individuals may revert to earlier learned behaviors or response patterns under stress. These findings suggest that emergency procedures should be extensively trained, and that the procedures themselves should be as compatible as possible with normal, regularly performed procedures.

5.6.3.6 Problem-Solving, Reasoning, and Decision-Making

Space flight is a complex, dynamic environment. It is characterized by the need for astronauts to make multiple interdependent, real-time decisions in reaction to both external changes and the effects of their past decisions. Logical decision-making is an important part of all science-based professions, in which specialists apply their knowledge in a given area to making informed decisions.

Decision-making can be regarded as an outcome of cognitive processes (reasoning and emotion) leading to the selection of a course of action among several alternatives in the real world. The context in which a decision is made can have an immense effect on decisions. The strategy used for processing

information, for example, depends on the number of alternatives to be considered. When the decision problem has two or three alternatives, people often use decision strategies that process all relevant information. When faced with more complex choice problems involving many alternatives, people often adopt simplifying heuristic strategies that are much more selective in the use of information.

Factors other than decision task properties can affect how a person decides how to solve a particular decision problem. Prior task knowledge (Alba & Hutchinson, 1987; Chi, Glaser, & Farr, 1988), expertise (Shanteau, 1988), and social factors (Tetlock, 1985) can all affect how one makes a decision. Flexibility of response to decision tasks is a key to survivability (Feldman & Lindell, 1990). For example, either Judy Resnick or Ellison Onizuka had the presence of mind to turn on Mike Smith's emergency air packs immediately after the Challenger explosion even though this option was never taught during ascent training.

Because people adjust their decision strategies depending on the decision task, decisions can sometimes be improved by rather straightforward, inexpensive changes to the information environment. However, making the information available is not enough; the available information must also be able to be processed (e.g., spatially co-locating information that has to be compared).

The contingent nature of decision processes also has important implications for user preferences. A person's preferences can be affected by subtle changes in the presentation of information or changes in the way questions are asked (Tversky & Sattath, 1979). The order of elements of a choice set can affect the preference order. This is relevant to the Constellation program because great emphasis is given to astronaut preferences toward design decisions.

The concern is for how a person makes a decision about complex problems that may not have arisen during training. People learn how to handle (or mishandle) risky decisions as a result of their experience of having to deal with different types of problems encountered at different times. When presented with a fresh problem, they may recall the types of problem in their previous experience that most resemble the one that now confronts them and apply whatever approach they considered successful.

Research on problem-solving by experts is relevant to astronaut problem-solving strategies. Through the initial planning and design activity, the expert hierarchically decomposes the problem into subproblems or subactivities (Simon, 1973). In this way the actual production of the solution or product, which would be taxing to working memory, is simplified and the task is limited to a succession of subproblems.

Research using naturalistic methods shows that in situations with greater time pressure, higher stakes, or increased ambiguities, experts use intuitive decision-making rather than structured approaches, following a recognition-primed decision approach to fit a set of indicators into the expert's experience and immediately arrive at a satisfactory course of action without weighing alternatives. Also, recent robust decision efforts have formally integrated uncertainty into the decision-making process. Recognition-primed decision (RPD) is a model of how people make quick, effective decisions when faced with complex situations. In this model, the decision-maker is assumed to generate a possible course of action, compare it to the constraints imposed by the situation, and select the first course of action that is not rejected. This technique has benefits in that it is rapid, but it is subject to serious failure in unusual or misidentified circumstances. It seems to be a valid model for how human decision-makers make decisions.

The RPD model identifies a reasonable reaction as the first one that is immediately considered. RPD combines two ways of developing a decision; the first is recognizing which course of action makes sense, and the second, evaluating the cause of action through imagination to see if the actions resulting from that decision make sense. However, the difference of being experienced or inexperienced plays a major factor in the decision-making processes.

RPD reveals a critical difference between experts and novices when they are presented with recurring situations. Experienced people will generally be able to come up with a decision more quickly because the situation may match a prototypical situation they have encountered before. This is one of the primary reasons for flight and ground crew participation in numerous mission simulations before the flight. Novices, lacking this experience, must cycle through different possibilities, and tend to use the first course of action that they believe will work. The inexperienced also have the tendency to use trial and error through their imagination.

A seasoned decision-maker will spend much more time and energy trying to diagnose a problem, and distinguishing between different explanations, than in comparing alternative solutions to a problem. This is where decision aiding could be beneficial, not in providing options for the person, but in problem diagnosis. Decision aids could also help with simulating the course of action chosen by the expert. The aid could help to identify weaknesses in the plan and provide improvement options.

Situation awareness (SA) involves being aware of what is happening around you to understand how information, events, and your own actions will affect your goals and objectives, both now and in the near future. SA has been recognized as a critical, yet often elusive, foundation for successful decision-making across a broad range of complex and dynamic systems, including aviation and air traffic control (e.g., Nullmeyer, Stella, Montijo, & Harden 2005), emergency response and military command and control operations (e.g., Blandford & Wong, 2004; Gorman, Cooke, & Winner 2006), and offshore oil and nuclear power plant management (e.g., Flin & O'Connor, 2001). Thus, SA is especially important in work domains where the information flow can be quite high and poor decisions may lead to serious consequences (e.g., piloting an airplane, functioning as a soldier, or treating critically ill or injured patients).

Designers of systems that provide decision support to humans should be aware of cognitive biases that can creep into human decision-making processes so that they can mitigate (or take advantage of) these biases. Table 5.6-2 lists some of the more commonly debated cognitive biases organized according to design considerations.

Table 5.6-2 Cognitive Biases

Information integration, communication, and presentation
Selective perception – We actively screen out information that we do not think is salient or important (e.g., Web site banner blindness).
Wishful thinking or optimism bias – We tend to want to see things in a positive light and this can distort our perception and thinking.
Anchoring and adjustment – Our decisions are unduly influenced by initial information that shapes our view of subsequent information.
Underestimating uncertainty and the illusion of control – We tend to underestimate future uncertainty because we tend to believe we have more control over events than we really do. We believe we have control to minimize potential problems in our decisions. Displays could include the probability of events determined by the “learning” software.
Selective search for evidence – We tend to be willing to gather facts that support certain conclusions but disregard other facts that support different conclusions.
Inertia – We have an unwillingness to change thought patterns that we have used in the past in the face of new circumstances.
Choice-supportive bias – We distort our memories of chosen and rejected options to make the chosen options seem relatively more attractive.

Decision Aids
Premature termination of search for evidence – We tend to accept the first alternative that looks like it might work.
Repetition bias – We have a willingness to believe what we have been told most often and by the greatest number of different sources.
Group think – We experience peer pressure to conform to the opinions held by the group.
Source credibility bias – We reject something if we have a bias against the person, organization, or group to which the person belongs: we are inclined to accept a statement by someone we like. Similar to the operant behavior of lab animals (no insult intended), human trust in automation is predictable. Itoh, Abe, & Tanaka (1999) found that, if the automation continuously malfunctions, the user’s trust will significantly decrease until the automation is no longer used, and that the longer the automation malfunctions, the longer the human distrusts it. On the other hand, occasional malfunctions have less of an effect on trust. The user may not depend on the automation for a difficult task, but this mistrust does not last long.
Incremental decision-making and escalating commitment – We look at a decision as a small step in a process and this tends to perpetuate a series of similar decisions.
Attribution asymmetry – We tend to attribute our success to our abilities and talents, but we attribute our failures to bad luck and external factors. We attribute others’ success to good luck, and their failures to their mistakes. This bias explains the common reaction to ASRS reports: “I would know better than to do that.”
Role fulfillment (self-fulfilling prophecy) – We conform to the decision-making expectations that others have of someone in our position.

5.6.3.7 Creative Thinking

Human space flight, particularly autonomous space flight, requires creative thinking. Play, or time off, is perhaps the most effective way to stimulate creative thinking. Astronaut schedules should allow adequate time off. Absence of time off may lead the problem-solver to become fixated on inappropriate strategies for solving a problem. The results of several tests have implications for creative thinking, such as the Wisconsin Card Sorting task and the Stroop task. In the Stroop task, for example, human subjects are asked to read color names presented in conflicting ink colors (for example, the word “RED” in green ink). Cognitive control is needed to perform this task, as the relatively overlearned and automatic behavior (word reading) has to be inhibited in favor of a less practiced task—naming the ink color. Both of these tests have been used in space analog environments.

5.6.4 Space Flight Stressors

The success and effectiveness of human space flight depends on the ability of crewmembers to maintain a high level of cognitive performance while operating and monitoring sophisticated instrumentation. Astronauts, however, commonly experience stressors known to impair human information-processing capabilities, including circadian disturbances, sleep deprivation, persistent “head stuffiness” as a result of 0g, long work hours, compressed work schedules, stress from high-risk and dangerous environments, noise, medication, and isolation from family. The deleterious effects of stress on performance are profound and pervasive. Stress has been shown to result in narrowed attention (Combs & Taylor, 1952; Easterbrook, 1959), decreased search behavior (Streufert & Streufert, 1981), longer reaction time to peripheral cues and decreased vigilance (Wachtel, 1968), degraded problem-solving (Yamamoto, 1984), and performance rigidity (Straw, Sandelands, & Dutton, 1981).

Some of the short-term space flight stressors are described below.

- *Noise stress.* Cognitive tasks are much more affected by noise stress than are psychomotor tasks (Theologus et al., 1973).
 - Sustained attention: Noise is associated with critical errors on tasks that require sustained attention (Cohen & Weinstein, 1981).
 - Working memory: When noise is uncontrollable, as it is on the ISS and will be on Orion, it results in increased errors on tasks requiring working memory such as digit recall (Finkelman, Zeitlin, Romoff, Friend, & Brown, 1979). Studies of dual-task performance indicate that people under noise stress tend to devote more effort to primary task performance at the expense of secondary tasks (Finkelman & Glass, 1970).
 - Judgment and decision-making: Broadbent (1979) found that under noise stress, when the probability of a signal was high, people were more likely to assert that they were confident that a signal was present or was not present (i.e., greater confidence in judgments).
- *Stress arising from threat and danger.* A threat-provoking situation is one in which dangerous and novel environmental events pose the potential for pain or discomfort.
 - Problem-solving: In realistic flight simulations, Smith (1979) found that multiple system failures resulted in numerous procedural errors by 20 flight crews, many of them arising from poor coordination among crewmembers.
- *Time pressure.* Many tasks assigned to the astronaut have some degree of temporal urgency.
 - Decision-making: Time pressure affects the way people make decisions (Perrow, 1984), particularly affecting the mental simulation required to evaluate the course of action

(Klein, 1996). Although reaction times tend to decrease under time pressure, so does accuracy (Lulofs, Wennekens, & Van Houtern, 1981). When under time pressure, people accentuate negative evidence and use less information in making decisions (Wright, 1974).

- *Fatigue and Circadian Disruption.* There are several explanations for the fatigue reported by astronauts upon return from space missions, including long work hours, compressed work schedules, anxiety produced by high-risk and dangerous environments, and persistent and high levels of auditory noise. In addition, astronauts commonly experience sleep disruption, sleeping only approximately 6 hours per day while in orbit (Monk et al., 1998). Laboratory experiments have shown that chronic reduction of sleep to 6 hours per day leads to cognitive performance impairment (Van Dongen et al., 2003). In addition, in space, circadian rhythms are disrupted because the 24-hour day-night cycle is absent.
 - Sustained attention: Sleep deprivation leads to reduced activation of attentional networks (in the frontal and parietal lobes) during a range of cognitive tasks.
 - Memory: Over the last 10 years, scientists have come to appreciate the complex relationships between sleep and memory. Not only does sleep prepare the brain for encoding new memories, sleep also provides an opportunity for the brain to consolidate and integrate recently learned information. At the molecular level, this memory formation is thought to depend on a process known as long-term potentiation, which strengthens the connections between nerve cells in a manner that makes it easier for signals to pass between them, as happens when memories are later recalled. Thus, sleep can make memories more stable, so that they are more resistant to interference and decay.
 - Declarative memories, such as a sequence of facts, benefit from adequate sleep, especially when subjects are also challenged with subsequent, competing information. After sleep, memories are resilient to disruption.
 - Procedural and motor memories, such as learning a certain sequence of dance steps, take root more solidly when paired with adequate rest.
 - Object identification is faster when the objects are studied the night before and subjects receive adequate sleep that night.
 - Motor responses (e.g., typing a sequence of numbers) are faster and more accurate when practiced the night before and subjects receive adequate sleep that night.
 - Problem-solving: Sleep also can identify, extract, and store key features of memories, leaving a memory that is more useful the next day. Thus a night of sleep can increase the likelihood that the solution to an ongoing problem will be realized (e.g., discovering a hidden shortcut for a mathematical procedure that you laboriously practiced the night before). Lack of sleep has been associated with a reduced ability to adequately prioritize tasks.
- *Hypoxia.* The brain uses approximately 20% of a person's total oxygen uptake and is therefore very vulnerable to reduction in oxygen partial pressure. Thus the earliest effects of hypoxia, or insufficient oxygen in the body, are the impairment of cerebral functions. There is wide variation between individuals, so it is not possible to predict when mental impairment may occur. The following higher-level cognitive functions are affected by insufficient oxygen (Townes et al., 1984):
 - Judgment and decision-making
 - Communication
 - Reaction times for problem-solving (e.g., tasks such as coding, number comparison, compass tasks, and pattern comparison; Bandaret & Lieberman, 1989)
 - Concentration
 - Normal inhibitory functions of common sense

Using Mt. Everest climbers as analogs for astronauts in deep space flight, Lieberman, Morey, Hochstadt, Larson, and Mather (2005) used the Wisconsin Card Sorting Test¹ (WCST) and mental arithmetic tests to simulate operational tasks encountered in space flight. WCST performance translates to the ability to change plans when circumstances change. At higher altitudes, error rates on the WCST and arithmetic tests tend to increase, and it takes longer to comprehend the meanings of sentences.

Time, exercise, cold, illness, and fatigue all influence the effects of hypoxia:

- The longer the time of exposure, the greater the effect.
 - Exercise increases the demand for oxygen.
 - Energy is required to generate heat to overcome low temperature, and this increases the demand for oxygen.
 - Illness similarly increases the body's energy demands.
 - Fatigue lowers the threshold for hypoxia symptoms.
- *Cosmic Radiation.* Acute and late central nervous system (CNS) risks from space radiation are worrisome for extended exploration missions to the Moon or Mars. Acute CNS risks include altered cognitive function, reduced motor function, and behavioral changes, which may affect performance and human health. The late CNS risks are possible neurological disorders such as dementia or premature aging. Radiation and synergistic effects of radiation with other space flight factors may affect neural tissues, which in turn may lead to changes in function or behavior (NASA Human Research Program, 2008).

Although some studies have shown that stressors can disrupt performance, other studies have focused on how the responses to stressors can sometimes be adaptive. For example, although noise as a stressor does reduce the range of cues attended to, this narrowing of attention can help focus attention on the critical part of the task (Hockey, 1970). In addition, moderate levels of time stress can improve performance, particularly in experts (Shanteau, 1988).

5.6.5 Cognitive Metrics

The ability to measure cognitive performance and its decrements may be important to assess readiness for critical tasks during long-duration space missions. Cognitive performance tests have been developed for the early assessment of performance decrements in the military, aviation, clinical psychology, and education. As of the mid-1990s, no objective measures had been taken of cognitive performance in astronauts (Fiedler, 2004). This need was recognized after a variety of stressors affected performance on *Mir*. Since then, several tests have been developed to assess possible changes in astronaut cognition during space travel; these include the Automated Neuropsychological Assessment Metrics (ANAM), Psychomotor Vigilance Test (PVT), NASA Performance Assessment Workstation (PAWS), MiniCog Rapid Assessment Battery (MRAB), and WinSCAT performance scales. Except for WinSCAT, these tests are not intended to be diagnostic tools, but they enable investigators to compare an astronaut's preflight, in-flight, and postflight scores to determine the relationship between space flight and cognitive abilities.

¹ In the WCST, a number of stimulus cards are presented to the participant. The participant is not told how to match the cards, but is told whether a particular match is right or wrong. The mistakes made during this learning process are analyzed to arrive at a score.

5.6.5.1 Cognitive Performance Tests

1) Automated Neuropsychological Assessment Metrics

ANAM is a validated, computerized cognitive testing battery consisting of a comprehensive set of cognitive subtests, a sleepiness rating scale, and a mood scale. It was developed over 15 years ago to assess the cognitive side effects of chemical warfare antidotes and pretreatment agents. ANAM has since been used to assess change in cognitive functioning secondary to pharmaceuticals.

The WinSCAT and PAWS cognitive tests are based on ANAM, which was developed by the Department of Defense, and have been used to assess astronaut cognitive performance in flight. There is a desire to have a computerized testing scheme for many reasons:

- For long-duration missions, new tests can be uplinked.
- The computer can administer the test in a strictly standardized, objective manner (subtle differences in how physicians administer tests can be eliminated).
- Computers allow flexibility in the presentation of test stimuli, facilitating changes in test characteristics (e.g., presentation time, colors).
- Computers can easily collect a wealth of information about an individual's test performance, including accuracy and RT.
- The computer can store, sort, and retrieve enormous amounts of information.
- Computerized tests can be designed to permit repeated testing and are therefore suitable for tracking the astronaut's status over time, including response to countermeasures.

Computerized measures are meant to provide initial hypotheses for further exploration, particularly if the test being administered is not comprehensive. The American Psychological Association (APA) Committee on Professional Standards and Committee on Psychological Tests and Assessment have published guidelines for computer-assisted evaluations.

2) WinSCAT

The WinSCAT has been used on many ISS missions. The number of astronauts taking the test is low and schedule demands sometimes take priority over repeated measures on the test.

The WinSCAT cognitive testing system was used on the 2007 Flashline Mars Arctic Research Station (FMARS) at Devon Island, Canada (Kobrick, 2007; Osburg & Sipes, 2004; Osburg, Sipes, & Fiedler, 2003). FMARS simulates a Mars mission because the island is very remote, the crew follows protocols such as wearing spacesuits every time they leave the habitat, an air revitalization protocol exists, the crew quarters are limited, the walls are not soundproof, distance communication technologies are used, physical training is used as a countermeasure to stress, and the Martian day (which is 39 minutes longer than an Earth day) is simulated.

3) NASA Performance Assessment Workstation

In the mid-1990s, the Air Force studied the effects of 0g on astronaut cognitive performance (Schlegel et al., 1995) using the Performance Assessment Workstation. The tests measured working memory, spatial processing, directed attention, tracking, and dual-task timesharing. The PAWS battery included a Mood Scale, Unstable Tracking, Spatial Matrix Rotation, Stenberg Memory Search, Continuous Recognition Memory, Directed Attention--Manikin and Mathematical Processing, Dual-Task, and a Fatigue Scale. Schlegel et al. (1995) found evidence for PAWS software reliability by measuring the effect of practice and practice schedules. In addition, they generated a database for classifying astronaut performance.

4) *The MiniCog Rapid Assessment Battery*

MRAB was developed on a personal digital assistant (PDA) platform with the intent of providing a portable cognitive testing device for astronauts. MRAB consists of nine cognitive tasks (including sustained attention, selective attention, divided attention, verbal and spatial working memory, cognitive flexibility as measured by the Odd-Man-Out test² and the Wisconsin Card Sorting Task, reasoning, mental rotation, and perceptual reaction times for picture matching and sentence comprehension).

Because the number of people who have experienced space flight is limited, researchers have simulated space flight in long-term isolation experiments on the ground. Cautious interpretation of these analogous environment studies is recommended since the effect of weightlessness cannot be taken into consideration.

MRAB has been used in several space analog environments. Lieberman et al. (2005) measured cognitive abilities in mountain climbers ascending Mt. Everest. Mountain climbing is considered a space analog because the environment is hypoxic, a small group is in close contact for an extended period, critical decisions are required, and many situations are life-threatening. Results showed that RT increases, cognitive flexibility decreases, and math error rates increase with elevation.

The small display size of the PDA proved challenging for test developers. Many previously validated tests had to be modified to fit on the display screen. In addition, the PDA durability in the testing environments was not adequate (Orasanu, personal communication).

5) *Psychomotor Vigilance Test*

The PVT was developed through Dinges' work with the National Space Biomedical Research Institute, NASA, the Department of Defense, and the National Institutes of Health. It measures reaction times and sustained attention, and the data is correlated with the astronaut's sleep-wake cycle, stress, self-reported workload, mood, and interpersonal interactions. Dinges collected PVT, physiological, and subjective data during three NASA Extreme Environment Mission Operations (NEEMO) missions (2006-2008). NEEMO is considered a space analog because it involves a small team working and solving problems together for a long period in an isolated and confined environment with noise and communication delays.

6) *Measure Mild Cognitive Impairment (MCI) Tests*

Following are just a few of the available computerized cognitive tests developed for MCI.

- CogScreen (Kay, 1995) is a group of 11 tests that takes about 30 minutes to complete. It is designed to detect subtle cognitive deficits that could affect aviation performance and is sensitive to mild neuropsychiatric disorder in general.
- MicroCog (Powell et al., 1996) was designed to assess mild cognitive decline in physicians and has been used extensively in older adults.
- The Cambridge Neuropsychological Test Automated Battery (CANTAB; Sahakian & Owen, 1992) includes computerized versions of several common neuropsychological tasks, accompanied by novel measures of RT and executive problem-solving, and has been used extensively in pharmacology and neurotoxicology research. With CANTAB, patients are tested with a touch-sensitive screen that determines motor response time, spatial recognition, and working memory. It also includes an electronic version of the Shallice Tower of London. This is a test of planning using increasingly complex puzzles.

- VigTrack and MAT tests are both used to assess vigilance in pilots and astronauts.

5.6.5.2 Test Validity, Reliability, Sensitivity, and Specificity

It is critical to ensure cognitive test validity, reliability, sensitivity, and specificity. A valid assessment is one that measures what it is intended to measure. For example, it would not be valid to assess astronaut EVA skills through a written test alone. A more valid way of assessing EVA skills would be through a combination of tests that help determine what an astronaut knows, such as through a written test and performance assessment in an analog environment (such as underwater). Reliability relates to the consistency of an assessment. A reliable assessment is one that consistently achieves similar results with the same (or similar) cohort of astronauts. Various factors affect reliability – including ambiguous questions, too many options, vague instructions, and poor training on the test. Sensitivity refers to the proportion of astronauts with a cognitive decrement who show this decrement on the test. Specificity refers to the proportion of astronauts without a decrement who do not show a decrement on the test. Because the astronaut population is small and the number of tests that have been given is even smaller, cognitive tests for astronauts may not have sufficient validity, reliability, sensitivity, and specificity. For example, because cognitive abilities lie on a continuum, some tests may not be sufficiently sensitive to detect MCI, particularly since most tests were designed for clinical populations such as patients with parkinsonism, Alzheimer dementia, schizophrenia, or concussion. In addition, sufficient practice to reach performance stability on cognitive assessment tests is critical (Schlegel et al., 1995).

5.6.6 Quantitative Models of Human Cognition

Understanding when the human operator is most vulnerable to stressors will permit the development and evaluation of mitigation strategies to reduce the likelihood of life- or mission-threatening contexts. Cognitive models and human performance models are two methods that have been used to predict these vulnerabilities.

Process models are analytic models rooted in theory that describes the processes by which a human output is generated and, as such, describe human performance within the system context, rather than simply predicting the results of the human's actions. The human processes that are embedded in the computational framework are based on empirical research collected over the past 50 to 60 years. Process models include human cognitive models and enable predictions of behavior based on elementary information processing, visual and auditory perception and attention, working memory, long-term memory, decision-making, response selection, and response execution models of human behaviors. The human process models are generally more powerful than those that simply describe observable behavior, because they can be generalized to a wider range of tasks and applications.

Models that predict human output (e.g., task timing and success) without predicting the range of human processes (i.e., attention and cognition) involved are known as performance models. Performance models use a set of relationships between input and output states to predict or describe the outputs of a person or a person-machine system for a given set of inputs. Such a performance-oriented model places no requirement on the internal structure, or even the validity, of the internal model processes. For example, a performance-oriented model may be used to simply ask whether a task that was programmed occurred, not that all of the correct processes were followed to complete the task. All that is desired is that the model produce useful (i.e., in the application context) outputs for specified inputs.

5.6.6.1 Human Performance Models

Human performance models (HPMs) use computer models of human processes to represent virtual human agents interacting with technologies and procedures in an operational environment. HPMs can take many forms, from the purely cognitive models built from empirical research and theories of human processes (e.g., attention, perception, decision-making, response times, and response characteristics) to digital human models, or physical models of human anthropometry, biomechanics, posture, movement, bones, and anatomy. Cognitive and physical HPMs can be combined to produce an integrated HPM that simulates human responses and predicts how humans interact with advanced technologies (Gore & Smith, 2006).

HPM simulations can be used throughout the the development process of a product, system, or technology to formulate procedures and training requirements, and to identify system vulnerabilities where potential human-system errors are likely to arise. These computational simulations have cost and efficiency advantages over waiting for the concept to be fully designed or evaluated using human-in-the-loop tests. The system model development process allows the product designer, system, or technology to fully examine many aspects of human-system performance with new technologies. Proper validation of an HPM is critical for effective use of HPM for operator safety, operator productivity, and efficient systems design.

A key to both the human process and HPM simulation methodology is that the human operator is simulated rather than physically present in the simulation environment. Only the characteristics associated with the simulated operator's performance are contained in the environment, and workload predictions, timing considerations, and system state information are produced as outputs of the model. Thus, the risks to the human operator and the costs associated with system experimentation are greatly reduced: no experimenters, no subjects, and no testing time (Gore & Corker, 2001).

Larger-scale HPMs have been used successfully in aerospace and military domains to visualize and evaluate human performance with conceptual designs (Corker & Smith, 1993; Corker, Lozito, & Pisanich, 1995; Gore & Corker, 2000; Gore & Milgram, 2006; Gore & Smith, 2006; Pew, Gluck, & Deutsch, 2005). Specific application domains of HPMs include emergency operator responding to emergencies in a telephone routing experiment, process control procedures undertaken in response to steam threshold violations, helicopter search and rescue procedures, astronaut (Space Shuttle) procedures in response to helium malfunction with two display suites on ascent, mission specialists conducting experiments in 0g according to different schedules of performance, examination of flight deck procedures for conceptual systems (e.g., the 1990s National Airspace System concept of "free flight" or the synthetic vision display concepts of the early 2000s), closed-loop modeling of time estimation and workload impact on task schedules for air traffic control performance, and more recent NextGen concepts requiring multi-crew situation awareness simulations of airport surface navigation.

Six NASA-related examples of larger-scale HPMs highlight the mission-related criticality of the HPMs developed for NASA in the 1999 through 2007 timeframe. In addition, one Army large-scale HPM effort illustrates the cross-domain applicability of the HPM approach to various command and control operations. A NASA HPM tool termed the Man-Machine Integration Design and Analysis System (MIDAS) has generated data output that was critical to support NASA's mission—human response times with conceptual designs and procedures for the Radio Technical Commission for Aeronautics (RTCA) concept of operations termed Free Flight (RTCA, 1995). MIDAS was used to predict the impact of procedural changes and advanced technologies on air traffic control performance. Corker, Gore, Fleming, and Lane (2000) addressed the issue of controller workload as a function of the mix of aircraft self-separating in the controllers' airspace. The study combined part-task simulation and follow-up human performance modeling to understand the mechanisms of impact of a procedural change

without any corresponding change to the controllers' technical support. The model predicted and the part-task study found an increase in certain aspects of controller workload in such mixed equipment settings.

HPMs have been developed to

- Support the Crew Exploration Vehicle display design in concert with human-in-the-loop simulation testing.
- Generate performance predictions (task timing and workload) and recommend procedural redesigns for operators working in a time-constrained 0g environment.
- Generate more accurate predictions of performance and operator error when operators engage in repetitive task performance.
- Generate more accurate predictions of performance and operator error during periods of high workload in time-pressured environments.

HPMs have indeed been used as a methodology to identify points when the human is vulnerable to error, which then perturbs into the system. The NASA Human Performance Modeling Element of the Aviation Safety Program illustrated this in a 6-year program (2000-2006) that saw five modeling teams (Atomic Component of Thought – Rationale [ACT-R], ACT-R + Improved Performance Research Integration Tool [IMPRINT], Air Man-Machine Integration Design and Analysis System [Air MIDAS], Distributed Operator Model Architecture [D-OMAR], and Attention-Situation Awareness – salient, effort, expectancy, valuable [ASA-SEEV]) exercise their modeling architectures in various aviation-related operational contexts (human error modeling during taxi operations, human visual requirements modeling during approach and landing operations). The models produced task timelines and task interleaving, error models, timing performance predictions, workload estimates, and situation awareness measures at various levels of fidelity, which were subjected to extensive validation efforts with human-in-the-loop simulation data. The five simulation efforts that were undertaken as part of a number of NASA programs are clear examples of when HPM simulations generated output that was critical to support NASA's aerospace missions.

For the Army, HPMs have been used to serve in support of battle management and opposing force simulation development in the Agent-Based Model Representation (AMBR) program. AMBR supported parallel development of ATC simulations in several model architectures (Executive Process-Interactive Control – Soar [EPIC-Soar], Distributed Cognition [DCOG], Cognition as a Network of Tasks / iGENTM [COGNET/iGENTM], and ACT-R). The report provides comparisons of the performance of models against that of humans in task interleaving, subjective workload and response times under several display conditions, and either with or without high-level architecture inter-model communication protocols. The analysis provides a relative performance comparison of the models.

HPMs have been under development for a number of years. The practical application of these models illustrates that the HPM approach and modeling human cognition, when framed correctly, provide real-world value for NASA missions, particularly when designing complex systems. HPMs can provide answers to design questions rapidly and many “what-if” design questions can be answered by tweaking the “baseline” HPMs that have been developed with the proposed augmentations in the future system under consideration.

5.6.6.2 Cognitive Models

Cognitive models and their architectures have been successfully used to evaluate cognitive design issues primarily in lower level human-computer interaction environments (Anderson, 1993; Lebiere, 2002). Some of the more commonly used cognitive architectures are the ACT-R, Soar, and EPIC. ACT-R

accounts for regularities in cognitive skill such as the recognition and recall of verbal material (e.g., the fan effect), and regularities in problem-solving strategies (Anderson, 1993; Anderson & Lebiere, 1998). Validation of ACT-R has generally been in the area of small problem-solving or memory tasks (pattern matching) given that it is best suited to modeling these low-level behaviors, while larger-scale efforts to validate ACT-R are beginning to occur, as completed in the AMBR (Gluck & Pew, 2005) and the NASA HPM project (Foyle & Hooey, 2007).

Soar (State, Operator And Result) is a parallel matching, parallel firing rule-based system that aims to represent both procedural and declarative knowledge and is used to model all capabilities of an artificially intelligent system and to model human cognition and behavior (Newell, 1990). Pew and Mavor (1998) outline that Soar has been applied extensively as a cognitive architecture and has been validated against human behavior in a wide variety of tasks including natural-language comprehension (Lewis, 1996, 1997a, 1997b), syllogistic reasoning (Polk & Newell, 1995), concept acquisition (Miller & Laird, 1996), use of a help system (Peck & John, 1992, Ritter & Larkin, 1994), learning and use of episodic information (Altmann & John, 1999), and various human-computer interaction tasks (Howes & Young, 1996, 1997; Rieman, 1996).

EPIC is a visual processing model that represents foveal, parafoveal, and peripheral vision. The output processors are items in modality-specific partitions of a working memory structure. Simulation outputs from the visual dimension are in terms of time to detect information and changes in ocular motor processors. In the auditory dimension, output is in terms of a temporally chained representation that decays with time. Tactile information is simply a time-based identification. EPIC has undergone a number of low-level validation efforts and has successfully produced both qualitative and quantitative data for the psychological refractory period (Meyer & Kieras, 1997), a dual tracking/stimulus-response task (Kieras & Meyer, 1997), a tracking/decision-making task (Kieras & Meyer, 1997), verbal working-memory tasks (Kieras et al., 1998), computer interface menu search, and a telephone operator call-completion task (Kieras, Woods, & Meyer, 1997).

5.6.7 Research Needs

In *Living Aloft: Human Requirement for Extended Spaceflight*, Connors et al. (1985) suggest that a coordinated and integrated use of assessment approaches will provide the data needed to understand human performance requirements during space flight. Research should tease out the effects of space flight stressors on cognitive performance so that appropriate countermeasures can be developed.

Test sensitivity and specificity should be determined for the WinSCAT performance scales in analog environments or astronaut cohort groups, similar to the previous work in determining test sensitivity and specificity in clinical samples.

Additional research is needed for human performance models validation. One of the issues in HPM validation is the lack of any standardized processes to ensure the validations are done correctly. Without a standardized process, it is difficult to accept HPM as an acceptable tool for human factors-related design applications.

5.7 COGNITIVE WORKLOAD

The relationship between workload and performance is a nuanced one (Casner & Gore, 2010). Some have attempted to define workload and have proposed that workload is the effort invested by the human operator in task performance; it arises from the interaction between a particular task (i.e., “taskload” measured as tasks per unit time) and the performer’s subjective impression of the effort required for the taskload’s performance. Workload may be associated with either physical or mental load. This section will focus on the mental (cognitive) aspects of workload. (The physical aspects are described in section 5.2, “Physical Workload.”) Too little and too much load can affect crew performance. Because only limited data and countermeasures are available for too little workload, this section will focus on excessive cognitive workload.

Simple approaches that attempt to maintain overall workload at an intermediate value are unlikely to achieve the desired results of achieving this optimized performance level (Gore et al., in press). The successful management or evaluation of workload must include a consideration of the individual tasks that operators must perform, the combinations of tasks that are performed during a work period, priorities among tasks, individual differences among operators, and the length of time that an operator is required to undertake tasks. As such, current recommendations on the use of workload measures for evaluating an individual’s workload are inconsistent (Boff, Kaufman, & Thomas, 1986; Casner, 2005; Gawron, 2008). Research points toward no one, single approach to determine the suitability of workload in various operational contexts. Different workload evaluations and techniques are needed at different phases of the development cycle (Wierwille & Eggemeier, 1993). This challenge is heightened when extending notions of workload measurement from single task measurement to system operations.

5.7.1 Workload Evaluation and Reduction in the System Development Cycle

Various tools, methods, and techniques have been employed to measure workload. These techniques are designed primarily for aviation contexts and have been applied to other highly procedural domains examining tasks *over short periods of time* (Gore et al., in press). Operations in space for extended missions lasting upwards of 30 days, however, are characterized as highly procedural but highly repetitive tasks completed at the same time every day with multiple crewmembers sharing in the task performance, often with complex systems simultaneously. As a result, both short-duration and long-duration workload measurement requirements need to be factored in when developing new systems for space operations.

A system is a collection of interoperable components, each with explicitly specified and bounded capabilities, working synergistically to perform value-added processing to enable the satisfaction of a mission-oriented operational need in a prescribed operating environment with a specified outcome and probability of success in a timely fashion (Newell, 1990). The components at one level are realized at the next level below, and so forth for the number of interacting elements in a system with multiple levels. Newell maintains that the human architecture is a build up of a hierarchy of multiple system levels, and that it cannot otherwise be structured. Simon suggested that system stability is possible only if stable subsystems exist (Simon, 1962). The interaction among levels and sublevels is clearly necessary for developing stable system architectures.

As is discussed below, excessive workload is an undesirable state, contributing to errors and the potential failure to manage unexpected extra tasks. Designers should avoid imposing such a state. This is accomplished by several actions. At the highest level, two complementary actions can be taken. Before a system is fielded, as it exists “on the drawing board,” its workload can be estimated by a task analysis (the assumption here being higher taskload = higher workload). Once an astronaut uses a completed

(i.e., built and fielded) system or system component, workload can then be reassessed and predictions can be verified and refined by comparing the workload estimates to the actuals.

In either the estimated or the actual case, if workload is found (or predicted) to be excessive, then decisions can be made to change equipment (the interface), alter the task requirements, automate some functions, or provide extensive training. The latter is usually the least desirable approach, but is often adopted.

Although the two approaches to workload measurement—assessment and prediction—are complementary: each has its own benefits and shortcomings. Assessments are made after the design is completed, whereas predictions can be made early in the development stages. The benefits of assessment are that it tends to be quite accurate, to the extent that measures are selected appropriately and multiple measures are used. But the shortcoming is that accurate assessment of the workload of a full-fielded system cannot be carried out until the full system is built, by definition. At this point in the design cycle, if workload is found to be excessive, it may be too late (and/or too costly) to undertake any major re-design to remedy the problem. Extensive training is then the only alternative solution.

Prediction can be done early in the design cycle. This is the ideal method of workload measurement. Designs can be modified with less expense before heavy investment in physical production is undertaken. However, the limits of prediction also mirror the strengths of assessment. At this writing, no fully valid predictive models of workload exist. Depending on the circumstances, predictive models may be 70% to 80% accurate in predicting high-workload designs and procedures. However, the question remains whether such an accuracy level is “good enough” to make designers abandon a concept that is predicted to produce excessive workload.

Assessment and prediction can be used in a complementary fashion; assessment gains in timeliness, while prediction gains in accuracy when both are used on component tasks of a full mission (e.g., flight control, communications protocol, and thrust fuel management) even if these components are required to be time-shared later in the full mission.

Three main themes related to the issues defined above are discussed in the following sections: first, workload is defined as the interaction between the crewmembers and the task, including the vital issue of what it means for workload to be “excessive,” and the concept of the “Red Line.” Next, the methods used to measure workload, those involved with prediction, and how both measurement and assessment tools are used to define “excessive” workload, are discussed. The effects of two solutions, automation and training, on workload are discussed along with those of stress and workload transition. Finally, the major research requirements that should be undertaken to fully predict cognitive workload are presented.

5.7.2 General Description of Workload

5.7.2.1 Workload and Performance

Workload evaluations and predictions have enhanced the design and operational use of systems, equipment, and procedures for several decades (Gawron, 2000; Moray, 1979, 1988). The performance of highly skilled operators of complex systems fails to attain required levels or completely breaks down for any number of reasons. For example, inappropriate or incompatible control-display relations may invite errors, sleep loss may reduce vigilance, or emergency procedures may be difficult to interpret. One of the most frequent and important sources of performance failures relates to non-optimal levels of workload imposed on the human operator. This relationship has been well documented for a wide range of activities that humans perform (e.g., driving, flying, monitoring, assembling, communicating, supervising, maintaining, entering data) in both real and simulated environments. Furthermore,

workload is known to present major challenges to crewmembers in such tasks as monitoring and controlling camera position while controlling a robotic arm, or docking a Space Shuttle orbiter.

Cognitive workload can be suboptimal either because it is too low due to low arousal, or too high due to excessive task demands, poor equipment design, or difficult environmental conditions. Technological advances (e.g., automation) introduced to improve system performance (and reduce workload) may sometimes create underload—that is, the operator simply monitors the automation, and removes them from the active control loop (Parasuraman, 1987) —or may shift operator workload from one locus to another without achieving the expected reduction in workload.

Although workload and performance are clearly related, the nature of this relationship is not straightforward; measures of operator and system performance and operator workload may be influenced by similar as well as different factors. In fact, operators may trade off workload and performance.

5.7.2.2 Workload Demands and Resources

The concept of cognitive workload is best represented in the graphs of Figure 5.7-1. The increasing demands imposed by a task are shown along the x-axis of both graphs. This demand increase influences two variables shown in the graphs: task performance (top graph) and the mental resources supplied by the operator (bottom graph). The top graph shows what would be observed by looking at the “end of the production line,” or the actual work accomplished. The bottom graph shows what would be measured if a “workload meter” were hooked up to the operator. Initially, with low task demands, the operator is using very few resources (bottom graph). As a consequence, the operator may be bored and become less alert or tend to other tasks. Task performance will likely be less than optimal. With increasing task demands, more operator resources are used (demanding operator attention), and performance (upper graph) will stabilize at an optimal level. A further increase in task demands will start to overload the operator. Operator resources will be less productive due to errors and delayed responses. As a result, task performance will drop off. The point on the x-axis where performance drops off is shown as the “Red Line.” On the left side of the “Red Line,” the operator can keep pace with task demands and may have reserve capacity. Performance remains “perfect” (or above some criterion level such as a response within 1 second, or flight path tracking within 1 meter). On the right side of the “Red Line,” resource demands exceed resource supply and performance breaks down. Thus, the lower graph in Figure 5.7-1 defines two “regions”:

- Reserve Capacity – operator has a reserve capacity of resources to devote to the task
- Overload – operator is overloaded or has exceeded his or her capability

Workload must not exceed “Red Line.” Workload must be to the left of the “Red Line,” so that the crewmember has the resources available to handle an unexpected emergency.

How important guidelines can be proposed for measuring changes in resource demand along the x-axis, despite the imperfect ability to specify the precise properties of the scale and the “Red Line,” is discussed below.

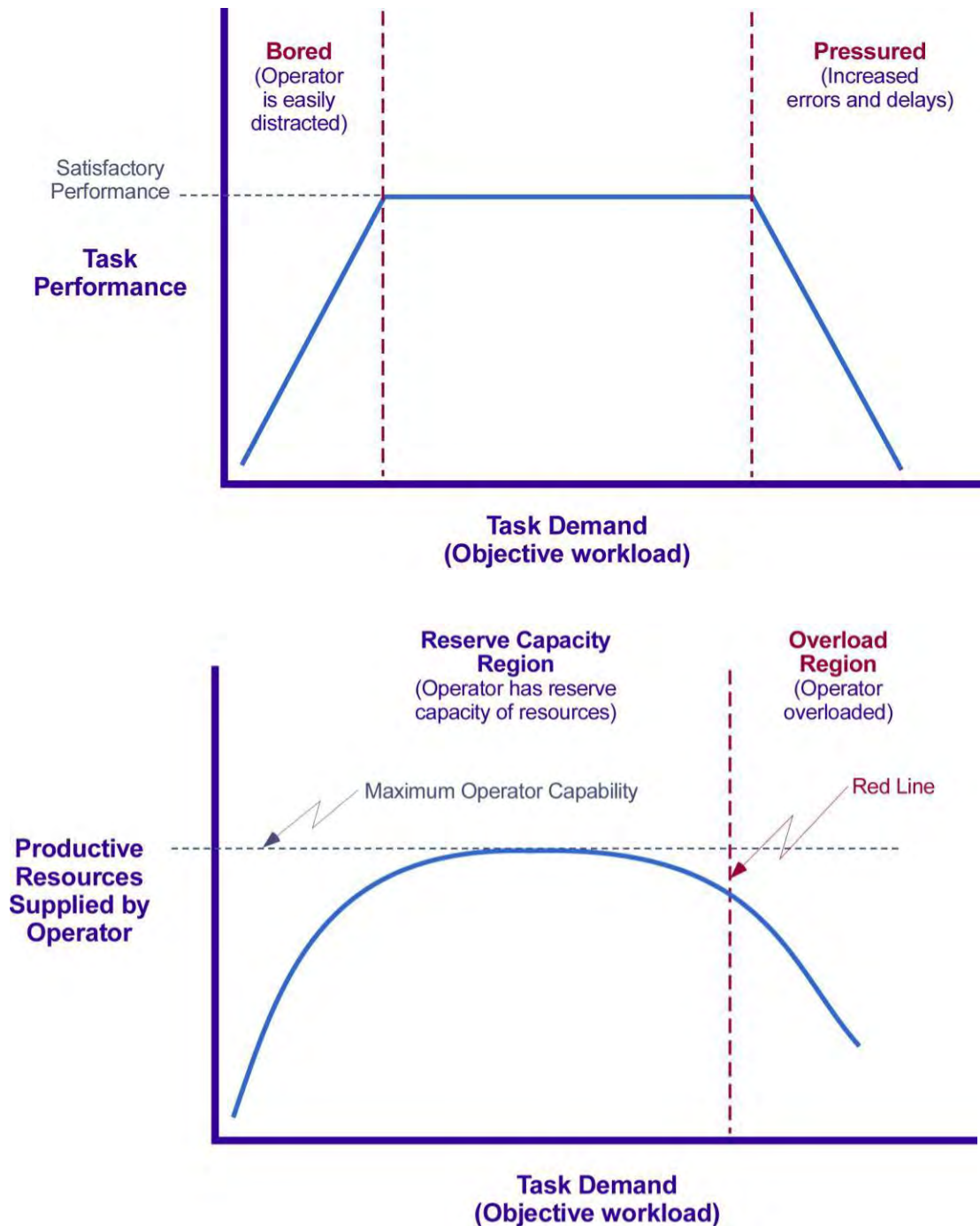


Figure 5.7-1 The effect of increasing task difficulty (or resource demand) from left to right on task performance.

The lower graph illustrates the two workload regions and the “Red Line” that divides the two, where primary task performance begins to fall off as the resource demands of tasks can no longer be met by increasing the supply.

5.7.2.3 Single Versus Multiple Task Demands

Numerous models of attention and performance have been proposed to explain the relationships found between task demands, workload, and performance (e.g., Gopher & Donchin, 1986; Hart & Wickens, 1990; Tsang & Vidulich, 2006; Wickens, 2002; Wickens & Yeh, 1988). These models dictate two categories of factors that drive increasing demands along the x-axis of Figure 5.7-1.

1. Single-task demands are factors like the forward speed of a vehicle, memory requirements for remembering parameter settings before they are entered, or time pressure. As these increase, performance will eventually suffer.
2. Dual-task demands refer to the increase in workload due to the requirement to perform two or more tasks at once, e.g., stabilizing a vehicle trajectory while searching the lunar surface for a level landing spot.

Multiple-resource models of attention are designed to predict and diagnose instances of excessive workload and performance breakdowns due to dual-task demands and suggest ways to mitigate these breakdowns. The following section addresses generic units that can quantify mental workload (or the demands along the x-axis in Figure 5.7-1) for both single- and dual-task demands.

5.7.3 Measures of Workload

A number of valid and practical measures have been developed that can quantify different aspects of the workload experienced by operators performing a wide variety of activities in very different environments. These measures can be distinguished by several criteria and by the questions about workload that each can answer. Since they vary with respect to the type and quality of information each offers, it is always best to use multiple measures to develop a complete workload profile and to obtain converging evidence from different sources.

(For descriptions of available measures, the situations in which they have [and have not] proven to be useful, and how to implement them, see David, 2000; Gawron, 2000; Gopher & Donchin, 1986; Hancock & Meshkati, 1988; Hansman, 2004; Hart, 1986; Hart & Wickens, 1990; Hill et al., 1992; Lysaght et al., 1989; Moray, 1979; Moray, 1988; O'Donnell & Eggemeier, 1986; Roscoe, 1987; and Tsang & Vidulich, 2006. In addition, several Web sites offer descriptions of measures and information about when and how to use them [e.g., Federal Aviation Administration (FAA), 2007, www.faa.gov]).

Operator workload is assessed by using four general categories of techniques:

1. Primary Task Performance Measures
2. Secondary Task Performance Measures – measures of performance on additional, “secondary” tasks introduced for the purpose of measuring residual attention or capacity
3. Physiological Measures – measures of covert response (e.g., changes in heart rate, eye blinks, eye movements, or electrical activity of the brain) generally referred to as “physiological” measures
4. Subjective Ratings – ratings provided by operators or observers

Specific examples of each of these will be described below.

Each of the above measure categories has costs and benefits. It is best to use a battery of at least two different metrics to obtain more reliable estimates of workload. The following factors should be considered when choosing a workload measurement tool:

- **Intrusiveness** – Intrusiveness is a clear and critical criterion in choosing a measure. It may contaminate primary task performance in a number of ways. Subjects may focus on the

workload measurement tool and lose perspective of the task demands, making subjective data inaccurate. The tool may add a false and unknown amount to the workload. Finally, operators may find the measurement process annoying, and thus disregard it (e.g., in the case of some synthetic secondary tasks). In this regard, embedded secondary tasks and physiological measures that depend on electrodes that are already present are best.

- **Context** – The context in which workload is assessed is important. For example, electrocardiogram (ECG) electrodes already in place for other (e.g., health monitoring) purposes invite easy assessment of heart-rate variability. In contrast, very noisy environments discourage the use of secondary tasks with auditory events. Mobile environments (e.g., EVA) discourage the use of tasks with manual responses, either for secondary tasks or to give subjective ratings. When operators are engaged in safety-critical missions, secondary task intrusiveness is a major concern.
- **Sensitivity** – The sensitivity of a measure describes the extent to which the measure changes when workload changes.
- **Reliability** – The reliability of a measure describes how consistently a measure will change when and only when the workload changes. A measure such as heart rate is not entirely reliable as a workload measure because many other nonworkload factors, such as physical exertion or stress, affect heart rate.
- **Diagnosticity** – The diagnosticity of the measure serves to identify the source of the high workload (e.g., perceptual load versus response load; see below).
- **Range** – The range of resources demanded by the task (see Figure 5.7-1) defines the levels of workload over which a workload measure is reliable.
 - Primary task performance measures should be used for the high-resource-demand (“overload”) region and is not a reliable measure of workload at lower task demand levels.
 - Secondary task performance and physiological measures are best suited for the lower-task-demand (“reserve capacity”) region.
 - Subjective ratings may be appropriate for the entire range.
- **Purpose** – Finally, the purpose of the workload assessment has some bearing on the choice of measure. If it is to establish the workload of a visual task (using, for example, a reformatted visual display), monitoring the operators’ scan patterns is an excellent approach. If the absolute level of workload in a full mission simulation is to be assessed, it is likely that a global measure such as subjective ratings using the National Aeronautics and Space Administration Task Load Index (NASA-TLX) will be ideal. If relative workload is to be assessed for multi-task environments that have generated unacceptable performance (e.g., to ask “How can the workload be reduced?”), then primary task performance measures are critical, particularly if these are coupled with models of the source of high workload (see 4.10.5.3.1, “Predictors of Workload”).

5.7.3.1 Measures of Primary Task Performance

Measures of performance can be used to assess workload. Caution should be used, however, because workload and performance can co-vary in different directions. It is important to understand the task under evaluation and the relationship between performance and workload. Sometimes high performance can be achieved at a cost of high workload for the highly motivated operator who is trying extremely hard to maximize performance. But at other times, good interface design or effective automation may allow high performance with very low workload. It is crucial, therefore, to understand the relationship between performance and workload as systems are compared. For example, two procedures for landing

a spacecraft might be compared: one, involving direct inner-loop control, provides very accurate performance but with excessive workload, as the human is involved at all phases with high-gain, precise, manual corrections. Workload is so high that the operator cannot perform any of the other required monitoring tasks. The other procedure involves flying using a tunnel displayed on a navigation screen that specifies acceptable deviations rather than pinpoint accuracy at the middle. This might result in a slightly higher tracking error; however, its workload will be lower, so a clear tradeoff could be made because the pilot now has ample spare attention for concurrent monitoring or communications requirements.

Primary task performance can often reveal the strategies by which operators adapt or adjust to high workload. Even for tasks that rely to a great extent on procedures, such as those performed during space operations, there is some flexibility in when and how to accomplish required tasks. Mission specialists may try to maintain acceptable performance on each of two concurrent tasks (by time sharing or rapidly switching between them), emphasize one task at the expense of the other, or perform the tasks sequentially. In fact, delaying the performance of one (less important) task in favor of another (more important) task may represent an optimal strategy.

5.7.3.1.1 Types of Primary Task Measures

Performance measures can provide objective answers to workload questions. Some measures summarize the effectiveness of an operator's actions, while others also provide information about the fine-grained structure of the operator's control strategies. The former reflect the combined output of the operator's behavior and system output, while the latter measure operator effort (and, thus, workload) more directly.

There are three classes of performance measures:

1. Speed – the time taken to start and/or complete a task
2. Accuracy and Error Rate – how closely discrete responses or continuous control deviations match a target value or acceptable range
3. Control Activity – amount of control activity such as the spectral power or amplitude of continuous control activity (e.g., the amount of manual thrust control)

Speed – With respect to speed, long times to perform a difficult task are generally associated with higher workload. So too are delays in initiating a task, either because events signaling the task are not noticed, or the operator has intentionally chosen to postpone their start until other aspects of the workload are lower. Such postponement is usually the case for lower priority tasks. For example, in flying tasks, communications are delayed and abbreviated (because they are perceived as lower priority) as other task demands increase. Tasks that require operators to keep track of time typically degrade as overall workload increases: steps are started too soon or too late, or insufficient time is allowed to complete required tasks (Hart, 1975).

Accuracy and Error Rate – An increase in the number of errors in either discrete tasks or continuous ones such as flight control (flight technical error) are often symptomatic of high workload.

For human performance tasks, accuracy and error can have two distinct meanings. Depending on the task, one can provide a clearer measurement of workload than the other. Errors refer to incorrect task performance: the operator may choose the wrong control, neglect to respond to a signal, or select the wrong switch position. Accuracy is a measure of the degree of successful task performance, the agreement between the actual value and the measurement, or between the target and selection. Accuracy can be measured by how well the operator does the task even if no errors are made.

Accuracy and errors are ambiguous and related to factors other than workload. For example:

- Given the speed/accuracy tradeoff, sometimes errors result from people choosing to make more errors in order to respond rapidly (Drury, 1993) instead of resulting from high workload.
- In some flight control tasks with considerable tolerance for errors, a reduction in error may be unnecessary and, in fact, symptomatic of high workload, as the operator tries too hard to keep error at an absolute minimum (e.g., deviating only 1 meter from a command flight path, when a 10-meter deviation is acceptable).
- Errors may occur at low levels of workload as the operator is “working on mental autopilot” (for example, a driver misses a turn because he was daydreaming). Such errors are, obviously, not diagnostic of high workload.

These qualifications do not mean that errors are invalid measures of workload; because of the operational importance of errors, those attributed to high workload can be of great importance. It only means that errors should be considered in conjunction with other factors that implicate a workload increase. Particularly important among these is the amount of control activity.

Control Activity – More control activity correlates with higher workload (the operator is doing more and doing it more often) (Corwin et al., 1988). In contrast to the accuracy/error category of primary task measures, control activity can help to identify reasons for high workload. Control activity can often be closely linked to the open-loop gain of the pilot in a control loop (Gopher & Wickens, 1977). This can also be measured by the power in a spectral analysis, or the root mean squared control and control velocity. In discrete tasks, control activity is closely related to time (e.g., number of keystrokes or button presses per unit of time).

5.7.3.1.2 Advantages and Disadvantages of Primary Task Measures

Longer response times, more errors, higher control activity, and fewer tasks completed are usually taken as evidence of increased workload. However, the actual relationships between workload and performance are more complex. O’Donnell and Eggemeier (1986) suggested that two classes of tasks define the differential usefulness of primary task measures, corresponding to the two regions of Figure 5.7-1: (1) For relatively easy tasks such as those to the left of the “Red Line” in Figure 5.7-1, consistent performance is maintained over a range of difficulty levels (although workload increases). (2) For moderately difficult tasks, such as those approaching and to the right of the “Red Line” in Figure 5.7-1, performance deteriorates monotonically as task demands increase (and workload increases). Finally, (3) for very difficult tasks, performance may have reached a floor level so that further increases in difficulty can produce no further loss in performance. Thus, measures of performance, task demands, and workload correlate for moderately difficult tasks but dissociate for very easy or very difficult tasks.

Some tasks may generate little measurable performance at all, despite a high level of cognitive effort. For example, many decision tasks involve a simple two-choice response (e.g., a “go-no go” launch decision). However, the outcome of that decision—measurable primary task performance—captures little or no information about the extensive mental workload that may be involved in making the decision. This is especially true for tasks supported by high levels of automation so that moment-to-moment operations depend entirely on the performance of the automated system, while operator inputs occur infrequently. Maintaining situation awareness is also a task with great workload demands, but may be reflected by minimal differences in primary task performance. Finally, some tasks do not have to be performed perfectly, as long as performance is good enough and completed by the deadline. This is another case where performance measures are insensitive to changes in workload.

5.7.3.1.3 Primary Task Measures Summary

Primary task performance is necessary, but far from sufficient, to assess workload. Gopher and Donchin (1986) concluded that direct measures of task performance are usually poor indicators of mental workload because they do not reflect the resource investments prompted by changes in task demands and do not diagnose the source of the load. In a review of the field that is often cited, Lysaght et al. (1989) concluded that primary task measures “should not be generally treated as appropriate for assessments of overall workload.” Taken together, these recommendations provide a strong note of caution about using primary task measures as the only measure of workload. Nevertheless, other measures of workload are virtually impossible to interpret without some information about performance. Tsang and Vidulich (2006, p. 250) summarized it nicely: “... although the primary task performance is clearly very important to system evaluators as a test of whether design goals have been achieved, primary task performance by itself typically does not provide an adequate test of the operator’s mental workload.” The other categories of measures will now be described.

5.7.3.2 Measures of Secondary Task Performance

Because measures of performance on the task of interest may not provide an adequate objective estimate of workload, the use of “secondary” tasks has been pursued as an alternative (Kalsbeek & Sykes, 1966; Rolfe, 1976). Here it is assumed that the additional demands imposed by a secondary task can challenge or exceed an operator's capabilities, and thereby provide an indirect measure of the resources demanded by the primary task. This in essence measures the reserve capacity or residual attention in the region to the left of the “Red Line” in Figure 5.7-1. Under ideal circumstances, secondary task performance degrades in direct proportion to increases in primary task workload. This has the potential of providing useful information, particularly in the reserve capacity region of the workload continuum where primary task performance measures are insensitive (see Figure 5.7-1). The approach is particularly appealing because one of the design goals of system developers and evaluators is to build systems that can be operated without fully taxing operators’ capacities, because such capacities would prove valuable in performing tasks associated with unexpected events or emergencies (Wickens, 2001).

5.7.3.2.1 Synthetic Secondary Tasks

Synthetic secondary tasks (as described below) are relatively simple activities added by the researcher for which input (visual, auditory) and output (verbal, manual) can be presented precisely and measured directly and accurately. Most have well-known and well-validated metric properties. The intervening cognitive processes are predicted by psychological models and inferred from variations in the speed and accuracy of performance. The following are several of the synthetic secondary tasks that have received the widest application. An exhaustive catalog of the results of secondary task research during its heyday may be found in Gawron (2000).

- **Response time** – Response time (RT) tasks generally include a visual or auditory stimulus presented during performance of a primary task. Operators respond by pressing a button or speaking into a microphone or voice-recognition system. Multiple-choice tasks are more sensitive than single-choice tasks, as they impose some information-processing and response-selection load. Response times and errors index increased with primary task workload (e.g., Kantowitz et al., 1987). Depending on the modality of input (visual or auditory) and output (voice or manual) selected, this task can be designed so as to require many of the same resources as those required by a specific primary task. The greater the degree of such overlap (e.g., visual-visual), the greater the sensitivity.

- **Monitoring** – Monitoring tasks present a series of stimulus events and do not require a rapid response to each. Since the operator is required to maintain a running count of the target events and respond periodically or at the end of the task, these tasks also impose a memory requirement. Count accuracy is usually the performance measure. While this approach expands the aspects of workload to which the measure is sensitive and reduces intrusiveness (because a response to each stimulus event is not required), it also reduces the frequency with which measurable behaviors are available for analysis. The number of errors (misses and false alarms) increases and count accuracy index is reduced in primary task workload (e.g., Kramer, Wickens & Donchin, 1983).
- **Time Estimation** – Time estimate production tasks require operators to produce a specific interval of time (usually in the range of 5 to 20 seconds) by manually pressing a button or verbally indicating its beginning and end (Zakay, 1996). As attention is drawn away from timekeeping, the length and variability of produced durations increase (e.g., Hart, McPherson, & Loomis, 1978). Although the demands of this task depend heavily on central processes, it has been found to be sensitive to variations in perceptual and motor load as well (e.g., simulated flight, Bortolussi, Kantowitz, & Hart, 1986, and Bortolussi, Hart, & Shively, 1989; navigation, Wierwille, Rahimi, & Casali, 1985; and precision hovering, Hartzell, 1979). When the requested interval is reduced to 1 or 2 seconds, performance on this task as well as many of the primary tasks with which it has been paired is impaired (Gawron, 2000), violating the criterion of intrusiveness. The results of four field evaluations conducted for the U.S. Army led Lysaght et al. (1989) to report that performance on a secondary time estimation task reflected different levels of workload on monitoring and flying primary tasks. (Note that the time estimate production described above is not the same thing as making a retrospective estimate of how much time has passed when the operator is asked, unexpectedly, how much time has passed since some event [e.g., since the beginning of a spacecraft maneuver]. Here, higher levels of workload may sometimes produce shorter, not longer, estimates, but such retrospective techniques do not seem to produce reliable estimates of workload.)
- **Mental Arithmetic** – Mental arithmetic tasks also require primarily cognitive resources. The difficulty of the task can be manipulated by increasing the number of digits or the number of operations performed. Performance is measured by the speed and accuracy of verbal, written, or typed responses. Although performance of this task has been found to be generally sensitive to variations in primary task load, some researchers have found that it interferes with primary task performance, violating the criterion of intrusiveness (Gawron, 2000). (On the other hand, see Andre, Heers, and Cashion [1995] for an application conducted in a flight simulation environment and Lysaght et al. [1989] for evidence of the sensitivity and nonintrusiveness of this measure.)
- **Memory Search** – Memory search tasks require operators to remember one or more letters, numbers, or words (the memory set) and then to respond as rapidly as possible whether or not subsequent stimuli (probes) were members of that memory set. As memory set size is increased, or as concurrent primary task demands are increased, response times generally increase as well (e.g., Lysaght et al., 1989; Manzey, Lorenz, Schiewe, Finell, & Thiele, 1995; Wickens et al., 1986). This task imposes loading on short-term memory, as well as on perceptual and response resources. Thus, it has also been found to interfere with some primary tasks that require similar resources. Importantly, this task has been used in space studies, and can be used to distinguish central (cognitive) load from perceptual-motor load (Manzey et al., 1995, 2004). Wickens et al. (1986) provide specific recommendations for use of memory search tasks in a flight environment.
- **Tracking** – Tracking tasks can provide a continuous index of primary task workload, although they are often impractical in operational environments. Manipulations that have different

difficulties (e.g., different forcing-function amplitude, bandwidth, order of control, open-loop instability, and number of axes controlled) create different patterns of interference with concurrent primary tasks (e.g., Jex & Clement, 1979; Lysaght et al., 1989; Wickens, 1986). In general, error about a target value increases as the difficulty of a concurrent task is increased. Tracking secondary tasks have the disadvantage of potentially being intrusive, depending on the primary task with which they are paired (Andre, Heers, & Cashion, 1995).

5.7.3.2.2 Synthetic Secondary Task Drawbacks

Four drawbacks of synthetic secondary tasks are recognized:

- **Intrusive** – Their greatest drawback is that many of them are intrusive, and because most were originally designed for purposes other than workload assessment, they seem artificial in operational settings. When engaged in safety-critical procedures in highly realistic environments, operators may divert their attention from the needs of the primary task when trying to do a secondary task and suffer a catastrophic failure of the former. Alternatively, they may simply disregard the secondary task as an unwanted annoyance, preventing any measurement at all.
- **Inappropriate** – A lesser drawback is that not all secondary tasks are equally appropriate for all primary tasks; the selection should be judicious. This is because, as noted above, to be most sensitive, a secondary task should use the same resources as the primary task. Concurrent tasks that require similar resources (such as two visual tasks) will interfere with each other, so that secondary tasks will be highly sensitive. However, a secondary task that requires resources different from those required by the primary task (such as a visual secondary task paired with an auditory primary task) is less likely to be a sensitive measure of the primary task. Furthermore, because performance decrements in both tasks are often found, the assumption that secondary tasks were performed only when primary task requirements were met was not always supported. These findings offer support for the use of multiple resources (Wickens, 1984, 2002, 2005, 2008) and ultimately constrain the utility of this measure to situations in which the resources demanded by the primary task are the same as those tapped by the secondary task (e.g., when both primary and secondary tasks are visual-spatial with a manual response).
- **Cover Only a Limited Task Period** – Secondary task performance reflects workload only at the times when tasks are introduced. They do not integrate over time.
- **May Affect Primary Tasks** – If operators modify their primary-task performance strategy when a secondary task is present, the information the secondary task provides about primary task workload becomes ambiguous.

5.7.3.2.3 Embedded Secondary Tasks

Embedded secondary tasks are clearly defined, “natural” parts of the repertoire of activities required in a specific operational environment (Shingledecker, 1984; Vidulich & Bortolussi, 1988). As indicated above, synthetic secondary tasks may be considered so irrelevant and uninteresting that their performance may be terminated altogether in operational environments. In contrast, the embedded method of presenting secondary tasks substantially improves user acceptance and increases the likelihood that operators will attempt to perform them (but appropriately delay or abandon them as workload becomes high). Many of the tasks described above can be modified so as to integrate them with an operational task. For example, a memory search task can be designed as a response to a radio call sign (Corwin et al., 1989). The time at which a particular routine activity, such as an altitude check, is performed can be treated as a time production. Discrete responses to alternative display configurations can be evaluated as reaction time or monitoring tasks. Ververs and Wickens (2000) recently demonstrated the effective use of secondary tasks to assess the benefits of alternative flight symbologies

for aircraft approach and landing. Embedded secondary tasks (such as detecting airspeed changes and conflict detections) aided in interpreting the results.

In fact, an embedded secondary task is essentially an aspect of the primary task ensemble that is particularly sensitive to overall task workload and can be singled out for analysis. Such tasks have inherently lower priority than the most important components of the primary tasks, whose workload demands are to be measured (Raby & Wickens, 1994). Thus one may consider, for example, a pilot's response time to communication probes while landing an aircraft, to be an embedded task.

5.7.3.2.4 Secondary Task Measures Summary

Performance on a concurrent, additional task can be used as an index of the reserve capacity remaining while a primary task is performed. The embedded secondary task can also provide diagnostic information about the specific resources required, as this reserve capacity is manifest in tasks “below the Red Line” in the context of Figure 5.7-1. However, secondary task performance may interfere with or change primary task performance (intrusiveness). Obviously secondary (i.e., unrelated to the mission) tasks may be inappropriate for many operational situations unless they are presented as embedded elements of the primary task. In addition, not all secondary tasks are equally sensitive to the specific types of demands imposed by different primary task activities. A lack of secondary task decrement can never be interpreted with certainty as evidence of low workload; it might just indicate that the resources required by that secondary task were not depleted by the performance of that primary task. Thus, the use of several secondary tasks, each of which demands a different combination of resources, can provide converging information about the sources and magnitudes of workload in a complex task.

Even though the initial promise of secondary tasks has not been realized, they are valuable for assessing complex systems (Tsang & Vidulich, 2006), particularly if they are implemented with careful consideration of the use of common resources and with instructions that strike a balance between “do not ignore” the secondary task and “do not let it intrude on primary task performance.” A thorough task analysis and a strong theoretical basis are necessary to select and implement secondary tasks successfully.

5.7.3.3 Measures of Physiological Functions

Physiological measures have a long history of being advocated as metrics of mental workload (e.g., Beatty & Kahneman, 1966; Kalsbeek & Sykes, 1966; Kramer & Parasuraman, 2008; Sirevaag et al., 1993). The theory behind the sensitivity of such measures to variations in mental workload is that as task difficulty is increased and more resources are demanded, the human operator mobilizes more resources or mental effort to cope with this demand. Such mobilization will be reflected in various manifestations of autonomic nervous system arousal (Kahneman, 1973) as well as in direct measures of brain activity. In addition, most physiological measures have the potentially appealing property that they do not require an overt response of the operator that could disrupt ongoing primary tasks. In this sense, they are less intrusive (although sometimes measuring devices like electrodes encumber performance). This is in contrast to secondary tasks and, as can be seen below, subjective measures.

5.7.3.3.1 Physiological Function Measurements

Some of the more popular measures are described very briefly in Table 5.7-1.

Table 5.7-1 Measures of Physiological Functions Used to Index Mental Workload (MWL)

Measure	Typical Results		Examples
	Increased MWL	Decreased MWL	
Heart rate (beats per minute)	Increase as stress-related aspects of workload increase	Decrease	Corwin et al., 1989a, b ; Wierwille et al., 1985
Heart rate variability (at low frequencies, around 0.10 Hertz [Hz])	Decrease	Increase	Mulder & Mulder, 1981; Prinzel, 2003; Sirevaag et al., 1993; Svennson et al., 1996; Vicente et al., 1987
Pupil diameter	Increase	Decrease	Backs & Walrath, 1992; Beatty, 1982; Just, Carpenter, & Miyake, 2003; Marshall, 2007; Tsai et al., 2007; Wierwille et al., 1985
Eye blink rate (blinks per minute)	Increase as workload increases	Decrease	Corwin et al., 1989; Marshall, 2007; Sirevaag et al., 1993; Stern & Skelly, 1984; Tsai et al., 2007; Wierwille et al., 1985
	Duration of closure		
Eye blink duration (duration of closure)	Increase with fatigue	Decrease	See above
Direction of eye gaze (number of fixations and their duration on target area)	Increase	Decrease	Helleberg & Wickens, 2003; Svennson et al., 1996; Wickens et al., 2003; Wierwille et al., 1985

Measure	Typical Results		Examples
	Increased MWL	Decreased MWL	
EEG activity •In task - <i>irrelevant</i> brain areas	Decrease	Increase	Gevins & Smith, 2007; Just, Carpenter, & Miyake, 2003; Kramer & Parasuraman, in press; Kramer & Weber, 2000; Kramer, Wickens, & Donchin, 1983; Prinzel, 2003; Sirevaag et al., 1993; Serman & Mann, 1995
•In task - <i>relevant</i> brain areas	Increase	Decrease	
Hormone levels (measured in blood, urine, or saliva)	Increase	No effect	Damos, 1991

EEG, electroencephalogram.

In many cases, however, physiological measures have not been successful. The following are potential problems with using physiological measures for evaluating workload in space operations:

- In one full mission flight simulation used to generate candidate workload measures of aircraft certification (Corwin et al., 1989a, 1989b), none of the physiological measures tested, except for heart rate, provided a sensitive workload index, and across five studies several have yielded inconsistent results.
- Heart rate is problematic in a space context because it will be strongly affected by stress level as well as physical load (that is, it is unreliable for measuring mental workload).
- In a general aviation flight simulation, Wierwille et al. (1985) failed to find that measures of blink rate, pupil diameter, and heart rate varied with workload.
- Limitations of their utility in the context of Air Traffic Control can be found in David (2000).
- Experience with the use of workload measures in space has been limited. Only one of the studies cited in Table 5.7-1 (Kramer et al., 1983) used a space-related task (robotics) manipulation.

5.7.3.3.2 Measures of Physiological Functions Summary

Collectively in these and other studies, most physiological measures are problematic because of their limited reliability. Thus, only positive recommendations (based on consistently demonstrated workload sensitivity) are offered for the following two measures:

- 1) **Low-frequency (0.1 Hz) variability of heart rate.** Heart rate normally waxes and wanes at a cycle time of around 10 seconds (0.10 Hz). It is found that the variation at this frequency consistently declines with higher cognitive load (e.g., heart rate tends to remain constant) in a way that does not seem to be contaminated with the higher frequency beat rate (which is affected also by physical load and stress). In space, low-frequency heart rate can be collected nonintrusively as heart rate is normally assessed by attached ECG electrodes. Of course, by definition, such a measure cannot easily capture rapid workload fluctuations (i.e., greater than about 0.1 Hz, or changes within less than 10 seconds; Veltman & Verwey, 1996).
- 2) **Direction of eye gaze.** This measure has two primary benefits. It has high face validity as a workload measure (e.g., people look longer at displays that impose greater information-

processing demands) and it has been thoroughly validated in high-fidelity flight research (Helleberg & Wickens, 2003; Sarter, Mumaw, & Wickens, 2007; Svensson et al., 1996; Wierwille et al., 1985). Furthermore, if workspace regions are fairly widely separated, as in the typical space vehicle, it is easy to use relatively gross measures like head orientation to make workload inferences as long as the operator is positioned (e.g., seated or tethered) in front of a workstation. For example, direction of gaze can discriminate between head-out glances and head-down glances in the cockpit as indices of head-down display workload. The two major limitations of this measure are that it does not capture overall workload, but only the workload of visually displayed tasks, relative to other visual areas in the workspace, and that it is often time- and computer-intensive to analyze.

5.7.3.4 Subjective Rating

Ratings are the most widely used measures of workload and they often serve as the criteria against which other measures and models are judged. They can provide an integrated summary of workload from the perspective of the operator, and are the most direct way to evaluate the human cost of task performance. Ratings may be provided by operators during or immediately after performing a task, by observers monitoring the behaviors of such operators in real time or from a video recording, or subject-matter experts providing more abstract judgments.

Rating scales generally consist of one or more subscales represented by an ordered sequence of response categories. Labels define the correspondence between stimuli (workload experiences) and responses (workload ratings) on each subscale. However, there is no direct relationship between values on any workload scale and specific, measurable phenomena in the physical world; furthermore, the intervals may not be psychologically equal, and practically speaking, the upper limit is not defined. Finally, most scales provide relative differences rather than absolute levels.

Ratings may be obtained while a task is being performed, during intervals between task segments, immediately upon its conclusion, or while watching a replay of their performance. Although ratings are generally obtained from the person actually performing a task, observers who can mentally project themselves into the situation experienced by the operator can provide useful information about workload using the same or different scales. For example, Johnston, Vincenzi, Radtke, Salter, and Freedman (2005) found that observer ratings obtained with NASA-TLX covaried with experimentally manipulated levels of task difficulty in flight simulation and were reliable across observers. On the other hand, it may be difficult for observers to infer, for a particular operator, the mental effort, stress, and psychological consequences of performing a task, no matter how familiar the observer is with the task and environment. This limits the information observer ratings can provide.

In successful demonstrations, the intervals of time evaluated have ranged from several minutes to many hours and have been either arbitrary in length (e.g., one rating every 5 minutes) or meaningful units of activities (e.g., completing a procedure, landing an aircraft). Thus, the activities performed within the rated intervals ranged from either relatively homogeneous to quite diverse.

Although no rating scale can represent any more than the rater's memory of what was experienced integrated across time, this has not proven to be as great a problem as it would seem. For example, in a series of studies comparing available workload measures, the four types of rating scales reviewed below were compared (Hill et al., 1992). Ratings were obtained during, immediately after, and long after the task was performed. The results demonstrated an acceptable level of rating stability across time. On the other hand, when ratings are obtained infrequently (to minimize interference with the primary task), they become necessarily insensitive to momentary variations in workload; not only may important information be lost if a rater forgets what she experienced by the time she is given an opportunity to

respond, but she must also integrate varied workload experiences to develop a summary rating. There is an obvious tradeoff between the sensitivity and precision offered by frequent ratings obtained during the task and the possibility of task performance disruption and rater “burnout.”

5.7.3.4.1 Subjective Rating Scales

Several rating scales have been developed that have provided valuable information in a wide variety of applications. These scales may be grouped into three categories:

- 1) Unidimensional or Global
- 2) Hierarchical
- 3) Multidimensional

Dozens of other rating scales are available, but they have not been used as widely nor subjected to adequate validation studies.

5.7.3.4.1.1 Unidimensional or Global Ratings

Unidimensional ratings involve asking a participant to provide a single workload rating during performance of the task. These ratings are easy to obtain and provide a convenient summary value. One such scale, the Pilot Objective/Subjective Workload Assessment Technique (POSWAT) was developed by the FAA (Stein, 1984) and used in an aviation environment, where it was found to be sensitive to pilot experience and flight-segment difficulty. However, unidimensional ratings provide no diagnostic information and between-rater variability is generally high (Byers, Bittner, & Hill, 1988; Hart & Staveland, 1988); different raters base their evaluations on different aspects of the situation. There is no standard format for unidimensional ratings, although most require raters to provide numeric values (using scales that range from 1 to 7, 1 to 10, or 1 to 100), descriptive labels (e.g., very low, low, and moderate), or magnitude estimates marked on scales presented on paper or a computer screen that are later converted to numeric values.

5.7.3.4.1.2 Hierarchical Ratings

In using hierarchical ratings, raters make a series of decisions, each of which discriminates between alternatives. Each decision leads the rater to another choice or to a final numeric rating. Hierarchical rating scales are easy to implement and score, and can be used without creating unacceptable interference in even demanding operational environments. It is crucial, however, that test subjects have sufficient training in how to interpret and use the scales. The order in which raters make decisions as they go through the tree process to arrive at a single rating was developed by trial and error for all of these scales, rather than being based on a well-founded theory of workload or extensive research. The psychological distance between the labeled workload categories has never been established for the descriptive categories; they do not provide diagnostic information and many users simply provide a numeric rating without going through the decision process. Finally, they have not received the extensive evaluation and application that other scales have received.

5.7.3.4.1.2.1 Handling Qualities Rating

The Cooper-Harper Handling Qualities Rating Scale (Cooper & Harper, 1969) was one of the earliest rating scales developed and is still used widely. Although it was developed to obtain subjective evaluations of aircraft handling qualities, subsequent applications have shown that it is sensitive to many factors that also influence workload. Raters make a series of decisions, each of which discriminates between two or three alternatives. Each decision leads the rater to another choice or to a final numeric rating ranging from 1 to 10. Raters may read the scale each time they provide a verbal or written rating

or do so from memory. Several modified versions of the scale have been developed that retain the decision-tree format and 10-point scale, but substitute terms that address workload more directly.

5.7.3.4.1.2.2 Modified Cooper-Harper

The Modified Cooper-Harper Scale (Wierwille, Casali, Connor, & Rahimi, 1986) is a variant of the original Cooper-Harper Rating Scale (scale descriptors were reworded). The structure and format of the scale were retained, but the wording of the questions and scale descriptors was changed to address mental workload explicitly. It has been tested in the laboratory, simulated flight, and Army field tests of ground-based systems (e.g., Wierwille, Rahimi, & Casali, 1985). Although it has been found to be sensitive to workload variations in simulated flight, it has proven to be less useful in other environments. Independent evaluations, such as those conducted by Hill et al. (1992), found that it was less sensitive than a simple unidimensional rating or the NASA-TLX (see below).

5.7.3.4.1.2.3 Bedford Workload Scale

The Bedford Scale (Roscoe, 1987) was developed for and with the help of test pilots at the Royal Aircraft Establishment in Bedford, England. It retained the decision-tree format familiar to test pilots, but modified the wording of the choice points to focus on spare capacity. It has been used widely in England and Europe to evaluate pilot workload in military and civilian aircraft and in simulation and flight research in the United States, but has received limited use in non-aviation environments. For this and other reasons, it has not been included in most of the large workload measure evaluation studies. It was one of several methods used to assess proposed upgrades for the Space Shuttle cockpit avionics displays (McCandless et al., 2005). Although the ratings were found to be sensitive to experimentally manipulated variations in load, the ratings provided no diagnostic information. The primary advantage of this and other decision-tree formats is that they separate the evaluation process into a series of explicit decisions. In particular, the Bedford scale provides an option that explicitly identifies a “Red Line” level of workload (0 reserve capacity). The primary disadvantage is that it is often less sensitive than other measures, provides no diagnostic information, and has received only limited use in the U.S.

5.7.3.4.1.3 Multidimensional Ratings

This group of rating scales includes two that have become industry standards, Subjective Workload Assessment Technique (SWAT) and NASA-TLX. They were designed with the underlying assumption that people can evaluate component factors more reliably than they can the global concept. Thus, one of their greatest strengths is that subscale ratings can provide diagnostic information about specific source of workload, while global summaries developed by combining weighted subscale ratings quantify overall workload experienced. This sort of information is useful, particularly early in design, as it allows designers to identify workload peaks and valleys to make decisions about how to allocate tasks, improve display or control designs, and establish training protocols.

5.7.3.4.1.3.1 SWAT

The subjective workload assessment technique or SWAT consists of three subscales (Reid, 1985; Reid & Colle, 1988):

- Time load
- Mental effort load
- Psychological stress load

Each subscale is represented by a three-point rating scale (1 = low, 2 = medium, and 3 = high). The 27 possible combinations of 3 levels of each of 3 scales are presented on individual cards for subjects to rank from lowest to highest workload. These rankings are used to create a 100-point unidimensional score. Each combination of ratings on the three subscales has a unique position on the overall workload scale that is assigned a numerical (global workload) value ranging from 0 to 27 (defined by the combination of all possible values). The sorting process, although time-consuming, is valuable as it provides an interval scale (Nygren, 1991) and considers at least some individual differences in workload definition.

SWAT has been used successfully to evaluate workload in the laboratory, simulation, flight research (e.g., Corwin et al., 1989a; Hancock, Williams, Manning, & Miyake, 1995), and various ground-based operations (e.g., Lysaght et al., 1989). Thus, evidence has accumulated that SWAT provides valid results and can be implemented in most environments, and the subscales offer valuable diagnostic information. However, in several head-to-head comparisons, SWAT was found to be less sensitive than NASA-TLX in the context of complex simulated transport flight operations (e.g., Battiste & Bortolussi, 1988; Corwin et al., 1989) and was not recommended for use in some of the more recent cross-measure comparisons (e.g., David, 2000; Rubio, Diaz, & Martin, 2004). The limited number of dimensions and interval scale values make SWAT attractive for use in operational settings; however, this limited range of allowable ratings (e.g., low, medium, and high) also reduces the sensitivity of the scale. Additional drawbacks are relatively high between-rater variability and low sensitivity in situations where overall workload levels are generally low (see, for example, Reid, 1985). Some SWAT users have dispensed with the tedious sorting procedure (by simply summing rated values on the subscales) and increased sensitivity by adopting continuous scales instead of three discrete choices (Adams & Biers, 2000; Luximon & Goonetilleke, 2001). Such variants have not achieved widespread use, however.

5.7.3.4.1.3.2 NASA-TLX

NASA-TLX provides an estimate of overall workload based on a weighted average of six subscale ratings: Mental Demand, Physical Demand, Temporal Demand, Own Performance, Effort, and Frustration (Hart & Staveland, 1988). Subscale ratings, which range from 1 to 100 in 5-point increments, are given verbally or by selecting a position along a scale presented on a rating form or computer screen. In addition, raters quantify the relative importance of each factor in creating the workload they experienced. These values, which range from 0 to 5, are used to weight the magnitude ratings when the overall workload score is computed. Diagnostic information is provided by variations in subscale ratings as well as the weight given to each factor. This process is less time-consuming than the sort required for SWAT and also provides a wider range of possible ratings per dimension.

Subscale ratings continue to play an important role in diagnosing workload peaks (Lee & Liu, 2003). NASA-TLX has been used successfully in a wide variety of environments and translated into many languages in addition to English (see Hart, 2006, for a review). In the past 15 years, many variants of the scale have been developed. Subscales have been dropped or redefined and new ones added to meet the needs of particular applications. Because one of the disadvantages of the TLX technique in its full form is the time taken to develop the weights before the study or provide ratings on all six subscales throughout the task, some users have elected to simply average subscale ratings (the so-called “Raw” TLX), dispense with computing any global value (Byers, Bittner, & Hill, 1989; Hendy, Hamilton, & Landry, 1993), and/or drop or redefine subscales thought to be less relevant to the task of interest.

5.7.3.4.2 Summary: Rating Scales

Rating scales are the most practical and generally applicable measure of workload. They are easy to implement and score, have face validity, and are acceptable in most environments and to most operators. The rank ordering of ratings is generally stable across raters, although the absolute values may exhibit considerable variability. Since workload is not completely defined by objective task demands (it can also reflect operators' physical and emotional states, pre-existing biases and experiences, and the environment in which the task is performed), the experiences of different individuals faced with identical task requirements may be somewhat different. In addition, raters may consider different variables when providing a rating (because their personal definitions of workload vary) and express different subjective biases that may have little to do with workload. These factors result in the primary drawback of subjective ratings: relatively high between-rater variability (Hart, 1993; Hart & Wickens, 1990).

In a frequently cited series of studies comparing available workload measures (Hill et al., 1992; Lysaght, 1989), generally high correlations were found between the four types of rating scales evaluated, suggesting that they all reflected the same "overall workload factor." Many of the scales were able to distinguish crew position, variations in task demands, and meaningful workload differences between mission segments. However, NASA-TLX ratings were more closely related to performance, and had the lowest between-rater variability, the best user acceptance, and the highest overall workload factor validity. Because of their sensitivity and the ease with which unidimensional scales can be implemented, the above authors recommended unidimensional scales for initial screening of gross workload levels, in preparation for a more diagnostic evaluation using a multidimensional rating scale, such as NASA-TLX. In aviation simulations, both Corwin et al. (1989) and Verwy & Veltman (1996) have identified specific limitations of SWAT.

Although improvement in the psychometric properties of workload rating scales might be warranted, their practical utility and the wealth of information they provide outweigh their limitations.

5.7.3.5 Workload Considerations

Although reliable techniques exist for measuring operator workload, surprisingly little attention has been directed toward the question of how workload affects performance in extended missions, particularly in extreme environments with expert operators such as those in the space domain. Classic human factors studies have demonstrated how prolonged periods of low workload can result in boredom and loss of awareness, while periods of high workload can lead to high error rates, narrowing of attention, and decreased awareness (Sheridan, 2002). The simplest interpretation of these results might lead one to conclude that workload is best maintained at an intermediate level, in which operators are neither pressed to their limits nor left to daydream.

A number of researchers have proposed the idea of designing for an optimal level of workload in which the operator is always engaged but never overtaxed (Casner & Gore, 2010; Guhe, Liao, Zhu, Ji, Gray, & Schoelles, 2005; Hart & Wickens, 2008). Unfortunately, even this simple idea is wrought with complications. First, there is little reason to believe that any constant level of workload will avoid problems with boredom and decreased awareness. Second, studies have challenged our simplistic notions of the tasks that result in low and high workloads by demonstrating how seemingly low-workload vigilance tasks can in fact be "capacity-draining assignments" that can yield high workload measures (Warm, Dember, & Hancock, 1996). Third, other studies show that not all workload is created equally. A recent NASA Ames study showed that pilots' navigational awareness varied with the amount of workload that was specifically devoted to the navigational task (Casner, 2005). Simply doing work

does not seem to guarantee awareness, or freedom from boredom, of anything in particular. A last challenge to the notion of an optimal level of workload is that there is simply no scientific support for the idea that working hard, then taking a break afterward, is a bad thing. In fact, periods of high workload may allow operators to practice the multitasking skills needed in high-tempo situations such as emergencies.

Of the many concerns that a space mission faces, one of the more challenging concerns surrounds the notion of workload measurement due to the dynamic nature of the operational environment (Gore et al., in press). The level of activity, the perceived difficulty of a task, the time-pressure in which to perform it, and the prospect of success or consequences of failure, play important roles in the accuracy, efficiency, and longevity of a crew whose survival is intertwined.

In the case of emergency or off-nominal conditions, the purpose of workload is to provide a protective envelope, a margin of time until the system is destroyed if the operator does not intervene, including a list of factors that can destroy a vehicle or its operator. Working backward from protective envelope ensures that an operator is not taxed beyond the means to respond as they implement procedures that avoid taking an erroneous action sequence. In nominal conditions, workload establishes the optimal boundary conditions that must be met in order to function. As an example, the first Skylab mission under-loaded the crew, so workload was increased for subsequent missions. Unfortunately, time had not been allotted for cleaning up, and stowage had not been considered. When the final crew for Skylab came aboard, work conditions were untenable, and the crew made a decision during the mission to halt their work until ground control created a suitable schedule that factored the clean up and stowage requirements into the schedule.

5.7.3.6 Conclusions: Workload Assessment

The choice of the best workload assessment technique clearly depends on a number of factors; critical among them is the region of Figure 5.7-1 where the workload in question is suspected to be.

- Primary task performance measurement may not be sensitive to important workload differences within the reserve capacity region, which, for many operations, is a desirable region for designers to seek. (Some amount of residual capacity will allow operators to address unexpected events without sacrificing ongoing tasks.)
- If embedded secondary tasks can be identified and carefully measured, these are desirable approaches within the reserve-capacity region.
- Although synthetic secondary tasks are sensitive measures of workload, they are less desirable for the reasons described above.
- Subjective measures, particularly those with higher resolution scales than the three levels of SWAT, can be useful across the entire range in Figure 5.7-1.
- Most physiological measures remain problematic, although eye movements can be diagnostic of the source of visual workload.
- The length of the task – short-duration or long-duration – must be determined.
- Must consider whether the workload measurement device is obtrusive into normal operations.

Whatever assessment techniques are used, it is strongly recommended that they be coupled with careful task analysis. Such analysis can support the complementary approach of workload prediction.

5.7.4 Predictors of Workload

It is often of great value to predict whether workload will be excessive (i.e., exceed the “Red Line” in the context of Figure 5.7-1) before a system is fielded or a procedure is implemented. Such predictions can be obtained by using computational workload models. Even in the absence of an absolute prediction, information about relative levels of workload can be of great value to identify

- The relative workload of different candidate procedures (e.g., what is the workload change imposed by hand flying versus monitoring automation flight in a docking or landing approach?)
- Which piece of equipment or interface will impose greater workload (e.g., a graphics versus a text display)
- The points in a mission where workload will be greatest, and thus the likelihood of workload-induced error will be greatest

Described below are three approaches to workload modeling that increase in complexity and sophistication: here, the benefits of more complex modeling for accurate prediction can be offset by the greater degree of expertise and training required to use them. These approaches are

- Table lookups
- Multiple-task models
- Dynamic simulation models

5.7.4.1 Predictors of Workload: Table Lookup for Single Task

The table of values used most frequently to characterize the workload imposed by the basic tasks and subtasks performed by human operators was developed by McCracken and Aldrich (1984; Aldrich, Szabo, & Bierbaum, 1989). This table has evolved in subsequent model development, and a current version used in Improved Research Interaction Tool (IMPRINT) is shown in Table 5.7-2. The values, however, are conventionally referred to as “McCracken & Aldrich” values. As can be seen in the table, seven different workload channels are defined. Within these, different tasks are defined along a scale of workload values ranging from 0 to a maximum of 7. Using this information, an analyst can identify the types of basic tasks that will be performed in a particular mission and then estimate the workload that might be experienced. For example, an analyst might compare the perceptual workload of a task that requires visually reading a symbol (5.1; Table 5.7-2, Panel G) with that of interpreting the semantic content of the spoken word generated by a synthesized voice display characterizing that symbol (3.0. Panel B) and predict that an interface involving the latter would impose lower workload than that of the former.

Table 5.7-2 McCracken & Aldrich Workload Demand Values

Auditory Demand Values		Cognitive Demand Values	
1.0	Detect / register sound (detect occurrence of sound)	1.0	Automatic (simple association)
2.0	Orient to sound (general orientation / attention)	1.2	Alternative selection
4.2	Orient to sound (selective orientation / attention)	4.6	Evaluation / judgment (consider single aspect)
4.3	Verify auditory feedback (detect occurrence of anticipated sound)	5.0	Rehearsal
5.0	Interpret semantic content (speech) – simple (1–2 words)	5.3	Encoding / decoding, recall
6.0	Interpret semantic content (speech) – complex (sentence)	6.8	Evaluation / judgment
6.6	Discriminate sound characteristics (detect auditory difference)	7.0	Estimation, calculation, conversion
7.0	Interpret sound patterns (pulse rates, etc.)		
Fine Motor Demand Values		Gross Motor Demand Values	
2.2	Discrete action (button, toggle, trigger)	1.0	Walking on level terrain
2.6	Continuous adjustment (flight control, sensor control)	2.0	Walking on uneven terrain
4.6	Manual (tracking)	3.0	Jogging on level terrain
5.5	Discrete adjustment (rotary, vertical thumbwheel, lever position)	3.5	Heavy lifting
6.5	Symbolic production (writing)	5.0	Jogging on uneven terrain
7.0	Serial discrete manipulation (keyboard)	6.0	Complex climbing
Speech (Voice) Demand Values		Tactile Demand Values	
2.0	Simple (1–2 words)	1.0	Alerting
4.0	Complex (sentence)	2.0	Simple discrimination
		4.0	Complex symbolic information
Visual Demand Values			
3.0	Visually register / detect (detect occurrence of image)		
3.0	Visually inspect / check (discrete inspection / static condition)		
4.4	Visually track / follow (maintain orientation)		
5.0	Visually discriminate (detect visual differences)		
5.1	Visually read (symbol)		
6.0	Visually scan / search monitor (continuous / serial inspection)		

An alternative approach to the values in Table 5.7-2 is to refer to a table of task attributes known to affect the basic workload of common tasks in a consistent way as represented in Table 5.7-3. Each entry is coupled with some examples. Such tables can serve as checklists of features designers should avoid and suggest attributes that can be changed to reduce workload. For example, any design change that reduces working memory load is likely to reduce operator workload.

Table 5.7-3 Sources of Mental Workload

Type of Load	Specific Examples
Perceptual load	<ul style="list-style-type: none"> • Signal-to-noise ratio: varying the brightness of text on a display, increasing the illumination of a workspace, obscuring a landing site by dust blowback • Amount of clutter in visual search: changing the amount of symbology on a map that is not relevant to the operator’s task • Legibility: varying the size of text and symbols, or their contrast ratio with the background. • Confusability between perceived elements: varying the extent to which symbols with different meaning sound or look similar (e.g., the code ALT vs. ATT for altitude and attitude). Coloring items with different meanings in the same color enhances confusability. Voice commands can also be confusable (e.g., “fly to” vs. “fly through”). • Spatial separation of elements that need to be compared: displaying a command value of a parameter and the actual value with which it is to be compared, on separate displays or separate panels.
Cognitive Load	<ul style="list-style-type: none"> • Working memory load (number of elements to be retained in memory before use): requiring that a 5- vs. a 3-digit number be looked up and entered into a keyboard. • Working memory time: requiring that the operator navigate (physically) to another location after looking up, but before entering, digits. This prolongs the time during which rehearsal of the digits is required. • Number of logical operations (e.g., negatives, true-false logic): interpreting the instructions, “If the light is not on, then do not start the component unless the vehicle state is not in motion.” • Need to mentally keep track of modes of automation: remembering that three different systems are in automated mode, when any of these could also be switched to manual mode. • Need to mentally predict variables: extrapolating the trajectory of a vehicle to predict the time and location of contact with a target, or mentally predicting the effect on trajectory change of a thrust input delivered for X seconds. • Need to translate between frames of reference: working a remote manipulator arm according to input from a camera placed on an external surface that is facing the arm.
Response Load	<ul style="list-style-type: none"> • Incompatible display-control relations: responding with a left button push to a right-positioned light; moving a slider downward to increase a value. • High precision of control requirement: requiring precision navigation within a 1-meter rather than a 3-meter tolerance. • Confusing (similar) response alternatives: positioning a slider to the right at position 7 has a qualitatively different effect from positioning it at position 8; two keys that are located close together look similar.

It is important to note that the entries in Table 5.7-3 cannot be used to compute the level of workload. For this, return to Table 5.7-2. However, all of the examples shown in Table 5.7-3 indicate design features that impact workload. For example, the second item (clutter) within the perceptual load entry, decluttering logic (Yeh & Wickens, 2001), can reduce the workload of searching through maps. For cognitive load, providing visible text that mimics digits that are spoken (and need to be remembered until entered) can reduce the working memory load. In another example of reducing cognitive workload, visual marking of key features in two display views or simply repositioning cameras can reduce problems of spatial frame of reference transformations (Wickens, Vincow, & Yeh, 2005).

Table 5.7-2, taken from the commercially available IMPRINT-PRO software (Imprint-info@arl.army.mil) or a similar representation in the Man-Machine Integration Design and Analysis System (MIDAS) (with a slight modification of cognitive resources dividing these into verbal and spatial components) can be easily used to compute the total workload imposed on a worker. (The most recent information on MIDAS can be found at <http://hsi.arc.nasa.gov/groups/midas>). One can, for example, add the workload values of all tasks carried out simultaneously. In the single-task situation, as described above, the workload of hearing a word is 2.1 “McCracken & Aldrich units” less than that of reading the same word (5.1 vs. 3.0). One can also compute the workload separately within a channel or category, determining for example that the visual workload (Table 5.7-2) imposed by the task combination of tracking (4.4) while reading a symbol (5.1) is 9.5.

This approach is adequate for several purposes; however, it is not fully accurate to predict multitask interference, or the level of workload within the overload region to the right of the “Red Line” in Figure 5.7-1 or the workload when two tasks compete for resources across different workload channels (e.g., comparing the workload of reading while tracking with that of listening while tracking; Wickens, 2008).

5.7.4.2 Predictors of Workload: Multiple Tasks

Multiple-task models characterize how two tasks will interfere or interact with each other when they are to be performed concurrently, such as when a pilot flies a path to touchdown while listening to communications that may call out hazards. These models will predict how far multitask performance will degrade relative to single-task baselines, as demands move to the right of the “Red Line” in Figure 5.7-1. Both static and dynamic multitask models exist. The former are computationally simpler and adequate for some uses. The latter are more complex, requiring more user training, but can make more precise predictions, as explained below.

5.7.4.2.1 Static Multitask Models: Single Resources

Static models are essentially analytic equations that can predict the workload of multitasking situations when two tasks are performed concurrently. The simplest form of a static model assumes that all tasks compete for a single resource: time. Using the Time-Line Analysis Procedure (TLAP; Parks & Boucek, 1989; Sarno & Wickens, 1995), the analyst simply lays out the times at which each task is performed. Each interval of time (e.g., 10 seconds) can be characterized by the ratio of time required to time available within that interval. For example, if one 7-second task is performed during the interval, workload = 70%. If two 6-second tasks are to be performed, workload = $(6+6)/10 = 120\%$. This model has the advantage of being simple and provides an output on a well-established ratio scale of time. At least one set of empirical results using TLAP (Parks & Boucek, 1989) provided data contributing to a “Red Line” estimate. Parks and Boucek assert that errors begin to occur in task performance when the ratio exceeds 80%. This type of static model “assumes” that all tasks are equivalent insofar as workload is concerned in a multitask environment, an assumption that is clearly an oversimplification, and so it will not always predict workload differences when these may actually be observed. For example, pilots

have little difficulty continuously monitoring and even controlling their flight path during a 10-second period (workload = 100%) while continuously conversing (workload = 100%), even when these tasks are imposed concurrently. This multitasking demand would yield 200% workload in such a time-occupancy model. Since the two tasks can be time-shared easily, observed performance would be at odds with the very high predicted workload.

Thus, TLAP models are best for predicting workload differences in the reserve capacity region to the left of the “Red Line” in Figure 5.7-1. They are appropriate with tasks that rely to a great extent on procedures, whose time estimates can be reliably specified. For example, during landing, an astronaut may be required to perform a series of discrete tasks, whose times are estimated, before touchdown. The percentage time can be determined, and evaluated against the time until touchdown. Increasing the speed of approach (thereby decreasing the time available) can be predicted to increase workload up to a point (here, the “Red Line”) in which not all tasks can be performed in the time available. In contrast, if the speed of approach is lowered and the resulting workload is computed to be 60%, it will be feasible to ask the astronaut to perform another task during this interval (perhaps off-loading a fellow crewmember who may have a workload of 100%).

A slight variation of the time-line model, accommodating differences in task demand, is a model that simply sums the workload of single task components, across channels obtained from a table lookup such as that in Table 5.7-2. However, such a model is still overly simplistic and does not fully account for dual task performance (Sarno & Wickens, 1995). This is because it is well known that two tasks that demand resources from within the same workload channel (e.g., two visual tasks) will tend to interfere more, and thus create more workload, than two that use different resource categories (e.g., a visual and an auditory task, or a psychomotor and a verbal task; Wickens, 2002). This means that such simple summing will overestimate the workload of tasks that require different channels or resources.

The human capability to use multiple resources in parallel should be considered when predicting workload. When it is considered, models are available (see next section) to make more accurate predictions (Sarno & Wickens, 1995; Wickens, Dixon, & Ambinder, 2006).

5.7.4.2.2 Static Multitask Models: Multiple Resources

From the above, the most comprehensive static model, the Multiple Resource Model (Horrey & Wickens, 2003; Sarno & Wickens, 1995; Wickens, 1991, 2002, 2005, 2008), is seen to generate workload predictions that are best tailored for the overload region of Figure 5.7-1 in dual-task situations. The Multiple Resource Model typically includes two additive components: one based on total demand (effort component) and one on resource overlap interference (Boles et al., 2007; Wickens, 2002, 2005, 2008).

The total demand component reflects the plenary demands of the concurrent tasks and can be estimated by summing the demands from a table such as that shown in Table 5.7-2. Alternatively, it can be estimated by simply assigning each task a value of 0 (fully automatic), 1 (easy), or 2 (difficult), and summing the values across tasks. This process would produce a predicted range of scores from 0 (minimum) to 4 (maximum) for a dual-task situation. This alternative approach has the advantage that it is not limited to tasks within the table, and that it provides values that are equally weighted to the resource overlap component.

The resource-sharing (or resource-overlap) component is based on the extent to which concurrent tasks demand resources along each of four dichotomous dimensions:

- Modalities (e.g., auditory versus visual)

- Visual channels (focal vision used for object recognition versus ambient vision used for ego-motion control and visual [versus instrument] flight path guidance)
- Processing codes (spatial [including spatially guided manual control such as tracking] versus verbal [linguistic] processes [including voice control])
- Stages of processing (perceptual-cognitive versus response)

Each task can be characterized by its reliance on one or more of these resource levels (e.g., the task of reading = visual, verbal, perceptual-cognitive).

Application of the model proceeds by counting, across the four dimensions, the number of cases in which two tasks require identical resources in each of these dimensions (e.g., both visual → 1 identity; both visual/spatial → 2 identities). An example of two visual tasks is reading a checklist while monitoring an altitude or speed tape. An example of two spatial tasks is keeping track of camera orientation while maneuvering a robotic arm toward a target (both of these are visual as well, and so they would share both a visual identity and a spatial identity). Again, the resulting values can range from 0 (no identity) to 4 (a level shared on all four dimensions). In a simplified version of such a model, these two components (total demand and resource sharing), added together and equally weighted, provide a predicted total interference measure that could range from 0 to 8.

Wickens (2002, 2005) provides a specific example of this calculation for a vehicle control task. A simple example of such a calculation in a space context is as follows. The astronaut needs to stabilize an alignment with an external object seen through the window while speaking corrections to the pilot (task A). At the same time, the astronaut needs to listen to instructions over the radio (task B). The first task is quite challenging because of the visual precision needed (demand = 2) while the second is fairly routine (demand = 1). Thus for the two tasks the total demand component = 3.

Regarding resource competition (C) on the four dimensions, the two do not compete for modalities (vision or audition; $C = 0$) and do not compete for focal or ambient vision (they cannot, since only one is visual; $C = 0$), but both compete for the common code, since both involve language (task A: speaking, task B: listening; $C = 1$). Finally on the stage of processing dimension, both compete for perception: seeing and listening are both perceptual activities ($C = 1$). Thus, the resource competition component is $0 + 0 + 1 + 1 = 2$, and the total workload predicted from the two components is $3 + 2 = 5$. If the task structure were changed to require the astronaut to monitor a visual (i.e., text) display for task B instead of a radio voice communication, the resource competition component would then be increased to 3, and the total workload increased to 6.

Validation studies have shown that this type of model can account for over 50% of variance (and as much as 90%) in dual task interference across a set of heterogeneous task combinations and interfaces used in aviation (Sarno & Wickens, 1995), driving (Horrey & Wickens, 2005), and robotics and unmanned vehicle control (Wickens, Dixon, & Ambinder, 2006).

It is important to note four limitations of the static multiple resource model:

1. First, it predicts only the total interference between two tasks; it specifies nothing about which task suffers (i.e., is of lower priority) and which is preserved (higher priority) when there is interference between them.
2. Second, it assumes that when two tasks compete heavily, operators will still try to complete them concurrently, thus suffering a performance loss in one or both (depending on priority). That is, it does not accommodate the possible actions of operators to reschedule one task or the other to avoid the overload of high resource conflict.
3. Third, the output of the model has not yet been compared against a “Red Line” value. That is, it is impossible to say, for example, that “4” is above the “Red Line.”

4. The model could feasibly be used for more than two simultaneous tasks; however, it has not been validated for these conditions.

In spite of these shortcomings, the benefit of a static multiple resource model is in establishing relative levels of dual task performance, imposed by different interface and task combinations (Wickens, Sandry, & Vidulich, 1983). This approach is computationally simple and requires neither a computer nor a special software package. Furthermore, the limitations of static models are to some extent addressed by the dynamic simulation models, described in the next subsection.

5.7.4.2.3 Predictors of Workload: Dynamic Simulation Models

Two computational models, IMPRINT (Laughery, LaBier, & Archer, 2006; Mitchell et al., 2003) and MIDAS (Gore, 2007; Gore & Corker, 2000; Smith & Gore, 2007), have advantages because they overcome some of the deficits described above, despite being more complex and requiring special software. In particular, they

- Allow the model user to lay out the set of tasks to be performed at certain times
- Specify the nominal task order that, by default, incorporates the expected task starting and completion times (In IMPRINT, variance in completion times can be specified as well.)
- Specify the demand in at least seven resource channels (IMPRINT: visual, auditory, tactile, cognitive, fine motor, gross motor, and voice response; MIDAS: distinguishes verbal and spatial cognition). Default demand levels are provided from lookup tables (e.g., Table 5.8-3)

Information about the two simulation models can be found at

MIDAS: <http://humansystems.arc.nasa.gov/groups/midas/> and at

IMPRINT: http://www.maad.com/index.pl/ongoing_projects#IMPRINT.

The two architectures differ with respect to the basis for workload-peak identification (totaled across channels or focused on an overload task within any one channel), resource competition coefficients (e.g., the conflict matrix used by W/Index, North & Riley, 1988; and MIDAS, Gore, 2007), and the consequences of overload.

When the simulation model is “run,” it specifies instances in which two (or more) tasks are carried out concurrently (i.e., one is initiated before another is terminated), produces a timeline, and uses the multiple resources algorithm described above to compute a workload profile over time based on task concurrence. While these time-varying, total workload values are not associated with a specific, empirically established workload level that should not be exceeded (a “Red Line” level), users may establish a “Red Line” for their own application or use the default values within the program. IMPRINT also allows the user to specify a series of workload management strategies for the model to implement when a “Red Line” is exceeded. These include the following:

- Allow both tasks to suffer
- Complete the ongoing task and wait to begin a second task until the first is completed
- Based on user-specified priorities, defer the lower-priority task until the higher-priority task is completed

Thus, when this model is run with either of the second two strategies implemented, the original high workload peaks that exceeded the “Red Line” value will be smoothed out considerably because one of the high workload-causing tasks is deferred. This mimics what a human might do, managing or deferring tasks to avoid overload and catastrophic consequences for high-priority tasks.

MIDAS operates a little differently from IMPRINT but does also allow the user to incorporate a workload management strategy. MIDAS schedules its tasks according to the following rules:

- Workload management set to false, a first-in, first-out principle is followed.
- Workload management set to true: If operator workload exceeds a user-defined threshold value per channel, the operator is deemed overloaded and the task is appended onto a list of decreasing priority tasks
- Highest priority task is completed first. That strategy used by MIDAS is based on Freed's (Freed, 2000) task scheduling research combined with that of Wickens & McCarley (Wickens & McCarley, 2008) – an algorithm that weights task importance, urgency, duration, and interrupt cost.
- A time estimation model (reported in Gore & Milgram, 2006) augments the MIDAS scheduler. It is a model of the operator's estimate of time available and the time required to complete the tasks in the specific workload environment.
- The output of the MIDAS workload model is a scenario timeline of workload output given scenario demands per workload channel. An overall workload is calculated post-hoc given the requirements of the research questions (for instance, focus only on visual and cognitive spatial for certain kinds of human-automation interaction questions, manual loads for other physical tasks).

A TEMPORA model (reported in Gore & Milgram, 2006) augments the MIDAS scheduler. TEMPORA is a model of time estimation that influences the task schedule. It is a model of the operator's estimate of time available and the time required to complete the tasks in the specific workload environment.

As of this writing, MIDAS and IMPRINT have not been compared in a “head-to-head” competition. Both require a considerable amount of expertise from the analyst to set up the model and the multitask scenario, and run the program. IMPRINT contains a well-designed user manual as a commercial product. MIDAS was developed in collaboration between the U.S. Army, NASA, academia, and industry.

5.7.4.2.4 Subjective Ratings as Predictors

It is possible for designers themselves to assign, as a predictive tool, subjective ratings of the difficulty they infer workers will have with a system using, for example, a NASA-TLX scale. Such values could be assigned either to a multitask ensemble as a whole or to the component tasks. On the one hand, such a technique needs to be used with extreme caution. There is no clear validation that such expert ratings will reflect what others will do or will experience. On the other hand, user expert opinion (not designer rating) may be required to rate the single-task difficulty of certain procedures or individual tasks, particularly those not well represented in the context of the task description in Table 5.7-2.

5.7.4.2.5 Predictors of Workload: Summary

As should be apparent, the main challenge of all three modeling approaches is that only the simplest (timeline analysis) provides a ratio scale of workload that can produce an empirically established “Red Line.” The elaborations of such a model that accommodate task demands and multiple resources do not provide such a scale, and thus do not provide a validated “Red Line” or “unacceptable” workload level. This makes establishing workload standards that are not arbitrary a somewhat problematic issue. Some dynamic simulation models can accommodate user-specified “Red Lines” and offer a default value (e.g., 60 in IMPRINT). However, the research community is still waiting for empirical validation of any particular value (or range of values) that leads to multiple-task performance breakdowns.

Despite some limitations, workload models have been used for some time to predict workload throughout system development. For example, an analysis of the US Army Comanche helicopter performed using IMPRINT/CREWCUT (Booher & Miminger, 2003) revealed that it would be impossible for one crewmember to perform the required mission, even with the assistance of automation. Thus, a two-crew configuration was recommended, with the result that the final decision was based in part on workload modeling.

The workload predictions of MIDAS have been used to estimate times to complete complex experiments on board the ISS (Gore & Smith, 2006; summarized in Hart, Dahn, Atencio, & Dalal, 2001). Procedure developers have used the workload spikes generated from the MIDAS model to redefine the procedures, to reduce the task demands on the operator while concurrently reducing the amount of time needed to complete the experiments, thereby reducing the risks to successful mission completion. In addition, the workload estimates (among a host of other measures) from MIDAS have been used in procedural analyses of various roles and responsibility manipulations given information requirements expected in the NextGen aviation domain (Gore, Hooey, Mahlstedt, & Foyle, 2012a,b).

5.7.5 Establishing Workload Limits

How do system developers know when a workload is too high or too low? People who study and apply human factors research, as well as their customers, have recognized the need for the workload “Red Line” discussed above—upper and lower boundaries drawn on a subjective rating scale, levels of secondary task performance, or a model output that workload must not exceed. Above these values performance will degrade, and below them, workload assessments will be based on measures of residual capacity, rather than primary task performance.

Three somewhat complementary approaches can be taken to identifying such a “Red Line”:

- One approach is to establish a somewhat arbitrary standard along a workload (or performance) scale, so as to define a mean rating of 5 on the NASA-TLX scales. At least one problem with this approach is that it is not possible to measure the workload of a particular combination of system and environment until the full system (or a human-in-the-loop simulation of it) is available to assess performance (or workload) accurately.
- An alternative approach is to seek reliable predictors of a discontinuity in the supply/demand/performance curve shown in Figure 5.7-1. The goal would be to specify this capacity in quantifiable units based on *a priori* task analysis. This is most appropriate for specifying workload limits for single tasks when time-sharing is not required.

The following subsection describes both approaches to defining a “Red Line.”

5.7.5.1 Workload Limits for Single Task Demands

The following three approaches are proposed to establish a workload “Red Line” for specific types of task demand (i.e., time, memory, and cognition).

Time Occupancy: As noted previously, Parks and Boucek (1989) argue that when a task requires 80% of the available time on a timeline, this defines a “Red Line” above which errors begin to occur. This approach is recommended when the workload level is clearly within the reserve capacity region of Figure 5.7-1.

Working Memory Load: It has long been recognized that the capacity of working memory is somewhere in the range of 5 to 7 “chunks” of information (e.g., unrelated digits; Card, Moran, & Newell, 1983; Miller, 1956). Thus, imposing demands greater than this will likely produce errors of

memory; for example, requiring the operator to retain an arbitrary 7-digit code from hearing to entering it on a keyboard. One could thus define a “Red Line” at 5, or conservatively at 4. As a design guideline, this approach is quite appropriate. However, such a measure is fairly specific to memory tasks and not more generally applied to other sorts of workload.

Cognitive Complexity: An approach to cognitive workload, related to memory capacity described above, is the quantification of relational complexity (Boag et al., 2006; Halford et al., 1995, 2002). Relational complexity can be defined as “the number of related variables that must be considered in parallel in order to solve a task problem” (Boag et al., 2006). For example, if solving an energy management or fuel conservation problem involves considering two variables (e.g., fuel needed minus fuel available), cognitive complexity = 2. If it involves considering three (fuel needed and fuel available as modulated by speed), complexity = 3. This variable is not task-specific and can be applied to activities as diverse as air traffic control, graph interpretation, or troubleshooting logic. Importantly, empirical data by Halford and colleagues has established that there is a discontinuity of performance speed and accuracy somewhere between three and four elements, indicating an upper workload boundary that could be used as a “Red Line.” Variation in relational complexity below this will not affect (single task) performance, but will affect the capacity available to perform additional concurrent tasks. Of course, such a measure applies only to cognitive elements.

5.7.5.2 Workload Limits for Multiple Task Demands

The above three approaches were proposed as ways to find workload “Red Lines” for specific types of task demand (i.e., time, memory, and cognition). However, they are less applicable to predicting the total workload of any operator, particularly one engaged in multitasking. It is not clear, for example, how to “add” the demands of a tracking (flight control) task to those of cognitive problem-solving to predict a “Red Line.” The output of computational workload models has the potential to define a workload “Red Line” (e.g., an IMPRINT workload of 60; Mitchell et al., 2003), but have yet to be validated in this regard.

All of the above techniques have the advantage that they can be derived from a task analysis (i.e., with no human-in-the-loop simulation required).

There is one additional approach to multitask “Red Line” estimates that is problematic (because full mission simulations are required to establish with validity the proximity of task demands to a workload “Red Line”). This is to define certain critical values along the subjective workload scales as being “unacceptable.” For example, Colle and Reid (2005) have argued that SWAT values above a rating of 40 produce an unacceptable loss of performance. Moray & Liao argued that a NASA-TLX rating above 60 produced unacceptable time-sharing behavior. However, neither of these cutoff values along the subjective workload scale seems to have been well validated.

Probably the most valid of subjective workload ratings, in terms of face validity, is the rating along the Bedford scale. As described above, the Bedford scale requires qualitative ratings or descriptions that explicitly rate reserve capacity. For a Bedford rating to be valid, the operator must be performing the full task in the operational environment or a full-mission simulation of it. This measure purports to quantify the operator’s own assessment of his reserve capacity. Thus, a Bedford rating of “6” corresponds to an operator’s judgment that the workload was satisfactory without any reduction in performance, but that he had little spare capacity; his level of effort allowed little attention to additional tasks. If that level of workload is deemed satisfactory for the task and environment being assessed, then a rating less than 6 could be deemed “below the Red Line” and a rating equal to or greater than 6 deemed “above the Red Line” and thus unacceptable. This “Red Line” relies on very close correspondence between the descriptors for each level of the scale, and the way they are interpreted by the raters and by whoever

established the criteria. And, finally, it is important to consider how accurately people can, in fact, estimate their capacity and how much has been used or remains.

5.7.5.3 Summary of Estimates of Workload Limits

In summary, there is no single optimal approach to providing a workload limit; rather, there are some contingent guidelines:

- If a reliable human-in-the-loop simulation can be performed (i.e., with enough participants to generalize), then the Bedford scale subjective measure can be collected, defining a limit of 6.
- When component tasks that use memory or cognition are analyzed, then the “Red Line” limits on these tasks can be used (keeping working memory load less than 5 chunks, and cognitive complexity less than 4). However, these limits might be overly optimistic if such processes are used within a concurrent task situation.
- If a series of procedural tasks are to be performed in isolation (i.e., without concurrent task requirements), then timeline analysis procedures can be used, limiting the ratio of time required to time available to be under 0.80.

If multiple complex tasks have to be performed concurrently, then either static equation or dynamic simulation models can be run. Periods of higher and lower workload will be output from these models. Although they cannot yet be placed on a “Red Line,” these procedures will reveal “red flags” of high workload, for which redesign, training, or task rescheduling and reassignment can be used. Then, when a full mission simulation is run, the performance and workload measures obtained can be cross-validated against the predicted workload values and the Bedford scale or NASA-TLX ratings associated with the point at which performance started to decline.

5.7.6 Workload and Other System Factors

5.7.6.1 Workload and Training

As noted in Tables 5.7-1 and 5.7-2, several task features impose workload. Clearly, however, not all people experience the same workload for a given task. Damos (1976) revealed in a study of novice versus expert pilots that the latter are far superior in time-sharing because many of the tasks are well learned or “automated,” demanding few resources (low workload) and thus making available plentiful resources for other tasks. Correspondingly, a given operator will experience diminishing workload on a task as it is practiced, here too making more resources available for additional tasks and acquiring better multitasking ability.

This general finding of reduced workload with practice has four important elaborations:

Task differences in achievement of automaticity: Research by Schneider and his colleagues (Fisk, Ackerman, & Schneider, 1987; Schneider & Shiffrin, 1977; Schneider, 1985) revealed that certain tasks are more likely to develop automaticity (low workload) from repeated practice than others. In particular, tasks that benefit the most from practice are consistently mapped in the brain: environmental or procedural conditions remain the same every time the task is performed. For example, a repeated sequence of the same keystrokes during an unchanging start-up procedure is consistently mapped. So is a trajectory maneuver with a particular robotic arm under a consistent set of operating conditions, or a landing maneuver to a flat (and thus consistent) lunar site. Extensive practice will allow it to be performed automatically, allowing at least some attention to be directed elsewhere. On the other hand, a corresponding task that may require an altered sequence depending on environmental conditions is called a varied mapped task. Repeated practice will not yield the same benefits. Such a difference has

led training experts to recommend that the most productive use of a limited amount of training time is to focus on training those consistently mapped elements that will produce the greatest reduction in workload (Fisk, Ackerman, & Schneider, 1987; Schneider, 1985).

The training curve: A fundamental principle of human learning and skill acquisition is that response times, error rates, and workload or resource demand will follow an exponential function of practice time; the greatest benefits will be realized early in training, with somewhat diminished returns later in training (Newell & Rosenbaum, 1983). Thus, if multiple consistently mapped skills are to be trained within a limited amount of time, it is optimal to distribute that training time more or less equally across all of them. This will yield the greatest collective benefit in developing some level of automaticity. Such a schedule will also benefit performance (e.g., speed or time reduction and accuracy or error reduction). However, in this regard it is important to note that full automaticity is reached only by overtraining well beyond the level at which error-free performance is obtained (Wickens et al., 2004). Thus, overtraining is a wise strategy, particularly for tasks that may need to be carried out in environments with very high workload, such as after emergency procedures.

Time-sharing skill: As people become more proficient with practice in multitask environments, they develop automaticity and the workload of component tasks is reduced, as described above. However, that is not all that is acquired with practice. Equally (and sometimes more) important is the acquisition of a skill in time-sharing. Such time-sharing and task management skills involve knowing when to focus on one task and ignore or postpone another; or knowing how long to neglect a background task before checking its status again. For example, the astronaut may be engaged in troubleshooting a failure, clearly a high-priority task that necessitates relegating other systems-monitoring tasks to a background status of lower priority. Yet the astronaut who is skilled in task management will still continue to monitor these other systems, but at a reduced rate. One without such skill may well succumb to cognitive tunneling or channeled attention (Dismukes et al., 2007; Moray & Rotenberg, 1989; Wickens, 2005; Wickens & Alexander, in press) and neglect totally all other tasks.

Workload and learning: Finally, workload is not only influenced by training, it can also affect the efficacy of training itself. In particular, successful learning requires attention and when learners attempt to master skills under conditions with extremely high workload, insufficient attention may be available to acquire the skills and knowledge being taught. Thus, designers of training regimes should be careful to balance challenging the trainee with creating such an overwhelmingly complex, multitask, high-workload environment that long-term knowledge acquisition becomes impossible (Schneider, 1985). The basic tenets of cognitive load theory in instructions are highly relevant here (Mayer & Moreno, 2003; Paas et al., 2003; Sweller, 1994; Wickens & McCarley, 2007; Wickens, Lee, Liu, & Gordon-Becker, 2004).

5.7.6.2 Workload, Automation, and Situation Awareness

A logical, and often successful, approach to problems of overload is to automate task functions, using a combination of software and hardware. The long history of flight deck automation certainly reveals the benefits of autopilots in reducing the attention demands of continuous inner-loop flight control (Billings, 1997; Degani, 2004; Wiener & Curry, 1980). Alerts and alarms, another form of automation, have drastically reduced the visual workload of continuous visual monitoring of variables like pressure, temperature, and altitude. In addition to these general benefits, three critical qualifications are discussed below.

Automation setup: First, the finding with automated systems and particularly the flight management system of the modern commercial airliner (e.g., Degani, 2004; Sarter, Mumaw, & Wickens, 2007; Sarter & Woods, 2004; Sarter, Woods, & Billings, 1997; Sheridan, 2002) is that, while many such systems

reduce workload when in normal operation, the setup or change in system functioning may impose considerably greater workload than does the system's nonautomated (manual) counterpart. For example, the number of procedural steps to change a runway on an approach using the flight management system can be so great that the workload imposed would be unacceptable, particularly in comparison to a similar change in a nonautomated aircraft that can be accomplished with only two steps.

Imperfect automation and situation awareness (SA): Second, the consequences of low workload while automation is in service are not always beneficial when conditions that are unexpected by the automated process develop. Here either the automation may not be programmed to handle the current circumstances (e.g., an unusual environmental input) or the automated system itself may "fail" (e.g., software bugs or hardware failures). Under such circumstances, we speak of the need for the human operator to "enter the loop." However, situation awareness is often low, because the operator had been devoting few resources to monitoring the process being controlled by that automation, (Endsley, 2006; Sarter, Woods, & Billings, 1997; Wickens, 2000). With low situation awareness, appropriate and timely action to deal with the failure may not occur; the action is either delayed (while situation awareness is restored by time-pressured information seeking) or erroneous.

Thus, automation should provide a balance between workload and situation awareness. Workload should be high enough to keep the human involved, but not so high as to overwhelm the operator so that situation awareness and performance become unacceptable. Also, it is sometimes possible to force operators to update SA by periodically turning off automation, or mandating that this be done (Kaber & Endsley, 2004; Parasuraman, Moloua, and Molloy, 1996). This is analogous, though at higher frequency, to requiring pilots periodically to "hand fly" an aircraft.

Alarms and alerts: Alarms and alerts are forms of automation explicitly designed to relieve workload of continuous visual monitoring of variables such as those related to engine parameters or trajectory adherence. If the alerts are reliable they will readily succeed in this goal. However, in many alerting systems certain features lead to inevitable errors, thereby reducing their reliability: (1) misses, where a true abnormal condition is not signaled, and (2) false alerts, where the alert sounds in a safe state (Dixon & Wickens, 2005; Getty et al., 1995; Pritchett, 2001). Perhaps the most important cause of such imperfections is the look-ahead time for predictive alerts, such as those used for collision avoidance in aircraft (Wickens & Colcombe, 2007). The longer this time is, the greater is the likelihood that the future state will be mispredicted, and one or the other type of error will occur.

The relative frequency of the two types of automation errors reflects the alert threshold specified by the designer (Allendorfer et al., 2007; Wickens et al., 2007; Wickens & Colcombe, 2007); low thresholds generate many false alarms, while the high threshold generates more misses. Both kinds of automation errors have consequences for human workload (Meyer, 2004; Dixon & Wickens, 2005; Parasuraman & Wickens, 2008). Miss-prone automation increases the visual workload. If the user suspects that a miss-prone automated alert system will not detect all events, he may monitor the raw data used by the alert system to maintain situation awareness, thereby increasing visual workload. On the other hand, false alarm-prone automation requires users to often divert unnecessary attention to the automation-monitored domain whenever the alert sounds, and further, leads to a general decline in trust of the system. Although designers generally prefer to set the threshold quite low, so as to avoid misses but produce false alarms, the workload cost of such a threshold setting is far from trivial (Dixon, Wickens, & McCarley, 2007).

5.7.6.3 Workload Transition

The previous discussion has focused heavily on measuring, modeling, and managing high workload. However, it is also important to realize that workload changes, independent of levels, can also be worthy

of concern (Huey & Wickens, 1992). Such changes can be in one of two directions. Sudden, unexpected workload increases, such as those produced by an unexpected crisis like the 9/11 attacks or the explosion in Apollo 13, can obviously leave the unprepared operator less capable of effectively handling the emergency. This becomes a highly relevant issue when pre-emergency conditions are those of very low workload, where sleep loss and decrements in vigilance monitoring can impair the normal monitoring of the system state (Huey & Wickens, 1992; Warm, 1983). (Note that when the unexpected event that induces the workload increase also places the operator at risk, this perceived danger factor may lead to a further impediment to the information-seeking necessary to understand what has happened, as the well documented effects of high stress on attentional tunneling are played out [e.g., Moray & Rotenberg, 1989; Rubenstein & Mason, 1987]). Constant maintenance of situation awareness and emergency response training are the best inoculation against such unexpected workload increases. In this light, it is to be noted that the attention resources necessary to maintain situation awareness represent one critical reason why workload must be maintained below the “Red Line,” so that such resources are available.

Correspondingly rapid decreases in workload, after intense periods of high load, can also leave the operator vulnerable to “letting down one’s guard” and/or recovering from the stress and mental effort depletion of the high-workload period. For example, mountaineering accidents are most prevalent after the summit has been reached, as the workload of the summit ascent has been reduced. In terms of remedies, training operators to make them aware that after emergencies or other high-workload periods they are particularly vulnerable to errors is one solution. Operators could be trained to identify these periods, and to closely monitor their own (and others’) performance for lapses during these times.

5.7.6.4 Workload and Long-Duration System Operations in Extreme Environments

Workload’s impact on operator performance in a long-duration operational domain is a challenge because workload is often measured along a different time scale than that which typifies the long-duration extreme environment operations. “Workload” may not even be the appropriate notion when examining human performance in a long-duration and extreme environment. Newell’s Unified Theory of Cognition outlines a logical relationship between the time scale and the theory that guides human action, some of which are more relevant for micro or macro levels of decomposition. For instance, when one considers task-related systems, the systems are operating within the rational band of performance. Performance in this band operates in the time unit of minutes to hours, a time frame that is akin to many of the empirical studies that measure human performance and workload (Casner 2009; Hart & Hauser, 1987; McCann et al., 2006; Vidulich & Tsang, 1987; Yeh & Wickens, 1988). Short-duration mission performance operations are designed to guard against workload that is too high or too low. The tasks experienced during a long-duration space mission duplicate short-duration; however, the very length of the extended mission presents an additional stress on the operator that is poorly understood in spaceflight missions. In addition, the cumulative impact that workload-inducing tasks might have on the operator’s general performance is ignored if one simply extends short-duration workload to long-duration operations. When time durations extend to days, weeks, months, and years, it is proposed that social factors such as loneliness and isolation will take on an increased role in influencing performance. These social factors influence the rational human operator, occasionally to the detriment of the system’s operation. The social band from Newell’s framework appears to be the band within the framework that parallels the long-duration mission behaviors, and can be used to couch the manner in which workload should be considered for system designs that involve repetitive long-duration mission operations (Newell, 1990).

The social band refers to a collection of interacting individuals and its impact on the performance of the system. The group of interacting individuals ceases to act rationally as a single agent. The social band includes social knowledge – goals, behavior, social position among the group members, emotion, affect, norms, values, morals, myths, conventions, and beliefs. The disjointed nature of the impact of the social role on human action makes incorporating it into a unified theory of cognition difficult; however, one approach to quantify the knowledge and the goals of the distributed agents is to represent workload's impact on long-duration mission performance, being sure to include the impact that stresses have on the system's performance. This band is highly influenced by a number of direct and indirect stressors.

5.7.6.4.1 Workload and the Long-Duration Mission Time-course

Long-duration missions will possess a different performance profile than missions of short durations, given their time course. Astronauts may experience long periods of low workload or outright boredom, punctuated with bursts of high workload to emergency and off-nominal conditions. Maintaining a ready engagement among crewmembers during extended periods of inactivity is essential to effective performance during periods of sudden critical activity. Additionally, the importance of managing workload increases in long-duration missions with regard to crew morale because crew cohesion decreases as length of stay increases. The criteria for success of the early Moon missions, which were characterized as being relatively short, were based on the physical survival of the astronauts and the proper functioning of the vehicle – i.e., “get there and back in one piece.” As missions become longer, social cohesion will come to play a larger role in the survival of the crewmembers, the maintenance of the vehicle, and the integrity of the mission success. In the past, crewmember composition was homogeneous as nations embarked onto space exploration with a single agency. Today, international collaboration and subsequent crew diversity is expanding, thereby leading to new challenges. These challenges become heightened as mission length increases. The phasic nature of human performance (see Gore et al., in press) influences long-duration mission designs and task requirements.

5.7.6.5 Workload and Stress

Although considerable attention has been devoted to the performance and medical consequences of missions performed in space, especially long-duration missions, relatively less attention has been devoted to the impact of the unique set of environmental stressors associated with space flight on crew workload. The focus of this section is on the relationship between stressors that are unique to this environment and workload. Some of the unique stressors that the crew might encounter are confinement, isolation, time pressure, and noise in addition to the potential challenges of performing tasks in greater- or less-than-Earth gravity. These environmental stressors are likely to affect sleep, mood, and vigilance. These, in turn, can affect how efficiently a crew will perform and, therefore, the workload they experience. But well-trained operators will adapt if properly prepared, and the duration of the experience is limited.

An exhaustive review of the effects of space-related stressors was performed by Bourne and Yaroush (2003) and will not be duplicated here. Another examination of the impact of environmental stressors on astronaut performance during an 8-day mission was performed by Manzey, Lorenz, Schieve, Filleli, and Thiele (1995). They found no significant effects on simple cognitive tasks, such as memory search and grammatical reasoning, using a battery of tests. In other studies, although initial decrements in performance (responses slowed, errors increased) and increases in workload were found, both recovered to levels close to those measured on Earth. This suggests another factor that should be taken into account when developing task schedules and procedures: schedules might be less demanding early in a mission

and critical tasks might be deferred, if possible, until performance recovers from initial environmental stresses.

Under stress, people tend to focus on the present; thus, lapses in prospective memory (remembering to take future actions) are more frequent (Dismukes & Nowinski, 2007). As alluded to in the previous section, emergencies are even more disruptive; they can be sudden, startling, confusing (hard to diagnose), complex, and stressful. Expected logical and temporal relationships are disrupted, or the operator's own lapses in memory disrupt well-learned and thus "automatic" behaviors, adding additional stress and workload. Designing procedures and decision aids for particularly stressful situations can reduce the likelihood of workload-related problems (Wickens, 1996). Furthermore, integrating formal team-building and stress-management training into procedural training can mitigate the effects of many environmental stressors; effective crews are substantially more resilient to unexpected events and stress (Orasanu & Becker, 1996).

In summary, the environmental stressors created by living and working in space modify the workload imposed by the cognitive, physical, and perceptual demands of the task. Such "performance modifying factors" can be incorporated into models used to predict workload (Laughery et al., 2006) and should be considered when extrapolating the results of simulations performed on Earth to the target environment. Although data are available that compare performance before, during, and after space missions, less information is available about the influence of space flight on workload. In either case, however, research is needed to incorporate available information into predictive models and workload assessment techniques to produce results better tailored to this environment. For example, the function followed by the workload associated with tracking task performance (characterized by a significant decrement during the first few weeks of space flight and again postflight, as shown by Manzey et al., 1995) may be similar to the function followed by the performance of this task, being higher during the periods when astronauts need to make physiological and psychological adjustments to very different environmental conditions. However, the magnitude of the effects of space flight on workload should be established through research and incorporated into assessment and prediction techniques to provide timely and useful information to designers.

5.7.7 Research Needs

As should be evident from the material described above, the greatest research needs in the field of mental workload are those that focus on validating predictive workload models that can predict when a "Red Line" will be crossed. The most complex predictive models (e.g., IMPRINT, MIDAS) contain no validated "Red Lines," and the simpler approaches that contain "Red Lines" are either overly simplistic for many environments (e.g., timeline analysis), cannot be deployed until the full system is fielded (e.g., Bedford ratings), or can be used only with respect to single-task components (e.g., cognitive complexity).

To meet these research needs, complex pilot-in-the-loop simulation needs to be carried out. This simulation should be coupled with careful measurement of performance, measurement of other workload assessment techniques, and application of predictive models. Ideally, such a simulation should also be accompanied by a manipulation of demand variables that are suspected to drive performance over the "Red Line," so that the discontinuity shown in Figure 5.7-1 can be identified, and both the predicted and assessed variables at that "Red Line" can be compared.

Useful websites:

<http://hsi.arc.nasa.gov/groups/midas>

<http://iac.dtic.mil/hsiac/Products.htm>

5.8 CREW COORDINATION AND COLLABORATION

5.8.1 Introduction

Future human space missions will be significantly different from current missions: they will be longer, the systems involved will be more complex, and resources will have to be used more efficiently. Furthermore, delays in communication between space crews and Earth-based support during Mars missions will necessitate greater crew autonomy than at present.

Success of exploration missions will depend in part on coordinated skilled performance by a distributed team that includes both the astronauts in space and the Mission Control personnel who support them. Other sections of this “Human Performance Capabilities” chapter deal with *individual* astronaut performance issues, such as visual or cognitive capabilities. This section deals exclusively with factors that influence *teamwork*, primarily in astronaut crews, but also in ground crews and in the interaction between the two. These extended crews are part of the integrated crew-vehicle system, which consists of the people and the spacecraft that transports the crew to space and sustains them in a hostile environment, including its equipment, software, information, and communication systems.

Coordinated and collaborative teamwork will be required to cope with challenging, complex problems during exploration missions. Crews sent to explore the Moon or Mars are likely to encounter unforeseen problems that will require them to make decisions affecting the success of the mission and even their own survival. Although thorough preflight training and procedures for abnormal and emergency events will equip crews to address technical problems that can be anticipated, preparing them to solve novel problems is much more challenging. Decisions may be required concerning interactive system failures or problems with the habitat, equipment, science procedures, EVA gear, or health of the crew. In some cases, decisions will be made with little or no support from the ground when communications are delayed or disrupted.

This section summarizes knowledge from several lines of research on crew factors that are relevant to the design and functioning of the crew-vehicle system. It builds on issues and limitations in current systems that have been identified through crew debriefings, questionnaires, and other sources of lessons learned from previous long-duration space flight missions involving the *Mir* space station and the ISS. It also draws on ground-based research conducted with various types of teams, especially those in high-risk, high-stress environments.

5.8.1.1 Definitions

5.8.1.1.1 Coordination and Collaboration

Investigators often distinguish between *coordination* and *collaboration* in teamwork. *Coordination* refers to an “attempt by multiple entities to act in concert in order to achieve a common goal by carrying out a script/plan they all understand” (Klein, 2001, p. 70). Tasks are largely procedural in nature, with specific subtasks assigned to different members; subtask interdependence arises from the need to accomplish tasks in the proper sequence specified in advance (Elliot, Shiflett, Hollenbeck, & Dalrymple, 2001). *Collaboration* refers to contributions to joint problem-solving, decision-making, or task completion that are not procedurally defined. According to Rawlings (2000), it is “the process of shared

creation: two or more individuals with complementary skills interacting to create a shared understanding that none had previously possessed or could have come to on their own.” It involves greater uncertainty and unpredictability than coordination. Collaboration is characterized by interdependence among team members in all aspects of a task, as individuals make unscripted contributions (O’Brien, 1968).

5.8.1.1.2 Team, Crew, and Group

Researchers use several different terms to refer to units of two or more people. In this section the following definitions are adopted:

Team. “A distinguishable set of two or more people who interact dynamically, interdependently, and adaptively toward a common and valued goal/objective/mission, who have each been assigned specific roles or functions to perform, and who have a limited life span of membership” (Salas, Dickinson, Converse, & Tannenbaum, 1992). Team members may be co-located or distributed in both space and time (as in shifts at Mission Control).

Crew. A crew is a specialized type of team, often smaller and more stable, that is trained to work together over a period of time, such as an astronaut crew.

Group. Groups are collections of people that, although their members are engaged in some common task, lack the task interdependence, specialized knowledge, and role differentiation of teams. Members may be homogenous or diverse in their knowledge, but this is not essential to their membership; members may be interchangeable, as in juries (Sundstrom, DeMeuse, & Futrell, 1990).

The term *crew* is used to refer to the astronauts and *team* refers to the larger unit that includes the astronauts and ground support personnel in Mission Control. *Teamwork* refers to the dynamic processes and interactions among members of a crew, team, or group as they engage in a common effort. In reporting on research in this section, the terms used by the investigators (i.e., crew, team, or group) are adopted.

5.8.1.1.3 Distributed Teamwork

When problems arise during missions in low Earth orbit, the crew can usually rely on assistance from Mission Control to solve the problem (as illustrated so brilliantly in the Apollo 13 mission). But successful joint efforts require communication and distributed teamwork. This joint work may include diagnosing the problem, developing plans, assessing risks, allocating tasks and resources, managing workload, and deciding what to do. Tradeoffs between completing mission tasks and ensuring the safety of the crew and equipment in time-critical situations, especially when problems are ambiguous and outcomes uncertain, will require analysis.

Two dimensions characterize the interaction of distributed teams:

1. *Extent of common expertise.* Common expertise refers to the extent to which team members have similar skills, training, and types of experience. Airline pilots have high levels of common expertise, despite differences in levels of experience, types of aircraft, or routes flown. In the operating room, the degree of common knowledge between nurses, anesthesiologists, and surgeons is substantially lower, though certainly above zero. In space operations, the crewmembers of a Shuttle mission typically have quite different backgrounds and training, such as piloting, medical, or scientific skills, though all receive common training on aspects of vehicle systems, procedures, and protocols. Likewise, Mission Control personnel are highly differentiated in terms of their expertise, but they have a core of common knowledge.
2. *Amount of shared data or information.* Data or information may be fully shared when team members are in the same physical location and are privy to the same information sources. Team

members who are not co-located may also share data or information through technology that provides access to common data sources. But even with collaborative work tools, shared information can be only partial among physically distributed teams. When important information is not technologically shared, team members may need to communicate it verbally, through written or spoken language.

A general rule of thumb is that the extent of common expertise and amount of shared information determine the amount of effort required to ensure effective coordination and collaboration (typically called “process cost,” Steiner, 1972); the greater the shared expertise and information, the lower the effort. Although distributed expertise contributes significant power to team performance, it extracts a price in increased communication and coordination, and possibly conflict over goals and strategies that must be resolved.

5.8.1.2 Section Overview

This section covers three major topics:

- *Ingredients of effective team coordination and collaboration:* Research in many high-risk, high-consequence domains has identified behaviors that characterize high-performing teams. These are described in section 5.8.2.
- *Challenges to effective teamwork:* Even highly trained and motivated teams sometimes fail to function as a cohesive unit, possibly leading to errors or poor solutions to emergent problems. These challenges and their impact on various components of crew functioning are described in section 5.8.3.
- *Techniques to support effective teamwork and team performance:* Four strategies to develop and sustain effective teamwork skills involve team design (selection and composition), team training, teamwork monitoring, and designing appropriate team collaboration tools. These strategies are described in section 5.8.4.

5.8.2 Components of Effective Team Coordination and Collaboration

This section describes the teamwork skills and behaviors that have been found to characterize effective team performance, especially in the face of complex high-risk, high-stress situations. These are the skills and behaviors that astronaut crews will need for successful coordination and collaboration during long-duration missions, especially during autonomous operations, when communications with ground are delayed or disrupted.

These components include the behaviors involved in developing shared mental models, team situation awareness, collaborative decision-making, metacognition, adaptive coordination behaviors, effective team communication, and team cohesion.

5.8.2.1 Shared Mental Models

For crewmembers to coordinate and collaborate effectively on team tasks, they must have shared knowledge and understanding of their environment, systems, operations, and team tasks and goals (Cannon-Bowers, Salas, & Converse, 1993; Orasanu, 1994). Mental models, or knowledge about elements and causal relations among system components, support interpretation of system cues, explanation of system events, and predictions of outcomes when other events occur (Rouse & Morris, 1986).

Shared mental models are developed initially through training; in operations they are supported by shared data or information, either from engineered systems or from communication among team members. Shared mental models are essential for coordinated actions among team members because they provide an integrated framework for how actions of all members are sequenced and fit together to reach the common goal. An important practical question concerns the optimal level and type of shared knowledge. Research indicates the following:

- High levels of shared knowledge lead to better performance (Kraiger & Wenzel, 1997). Specifically, teams with highly shared *team* mental models perform significantly better than those with less well-developed team models (Smith-Jentsch, Campbell, Milanovich, & Reynolds, 2001). These models include knowledge about the engineered system with which they interact—system components, procedures, and crew roles and responsibilities. Another element is knowledge about team interaction and coordination processes, such as who has what information, how and when it should be shared, and what others are likely to do.
- On the other hand, there is an advantage to team members having different knowledge bases and perspectives on problem-solving and decision-making (Kleinman, Luh, Pattipati, & Serfaty, 1992; Orasanu et al., 1993). Superior team performance is associated with *partial* overlap of responsibilities and information, which permits adaptive workload tradeoffs under high-workload conditions (Cooke, Kiekel, & Helm, 2001).

Fully shared understanding of *goals* and *constraints* may be most important for effective team decision-making, rather than fully shared task-specific knowledge. Shared understanding of goals enables team members to reach common understanding of situations and to contribute appropriately to problem resolution (Orasanu, 1994).

5.8.2.1.1 Team Situation Awareness

Distributed teams have to develop shared situation models, also known as team situation awareness (team SA), to make effective collaborative decisions under dynamic conditions. Shared team SA is a subset of more generic “shared mental models,” and reflects a shared understanding of an emergent situation that requires the crew to make a decision (Endsley & Jones, 2001). Team SA also is needed to ensure team coordination. Crews must have shared awareness of the cues that signal initiation and progress of a coordinated task, like a string quartet playing without a conductor.

Team situation awareness may develop spontaneously if all team members attend to and interpret environmental cues similarly. However, it is risky to assume that all team members have equal access to information about an emerging problem or have the same understanding of what the information means. Even when team members have the same data, they may still interpret it differently (Bearman, Paletz, Orasanu, Farlow, & Bernhard, 2005; Davison & Orasanu, 2001; Fischer & Orasanu, 2000a; Fischer, Orasanu, & Davison, 2003). A more solid approach is for the crew to develop shared awareness through communication (Orasanu, 1994). Without building shared models, the crew runs the risk of producing an uncoordinated response, with members pursuing somewhat different goals (Robertson & Endsley, 1995).

Updated situation awareness is essential for dynamic replanning when conditions change. A plan is predicated on a set of requisite conditions; if those conditions no longer hold, the plan may need to be altered. For example, in aviation, a plan to fly a certain route depends on the weather along that route. If weather deteriorates en route, then the route must be changed. Failure to adjust the plan, a so-called “plan continuation error” (Orasanu, Martin, & Davison, 2002), may put the flight at risk, a problem evident in a number of aviation accidents (Berman, 1995). Effective cockpit crews have been found to develop contingency plans that specify what will be done *if* or *when* particular conditions arise (Orasanu,

1995; Stout, Cannon-Bowers, & Salas, 1996). The success of contingency plans depends on situation monitoring to maintain updated team SA. These are prime ingredients of successful collaborative decision-making.

5.8.2.2 Collaborative Decision-Making

Robust and flexible collaborative decision-making—both within the crew and between crew and ground—will be one of the most critical skills to develop for exploration missions. Decision-making is collaborative when different team members have different information, capabilities, resources, and perspectives, and when the problem is sufficiently complex that its solution requires the concerted efforts of all team members. Ambiguous cues, dynamic conditions, high workload, time pressure, and uncertain outcomes make decisions particularly difficult and can create stress for the decision-makers (Cannon-Bowers & Salas, 1998; Orasanu et al., 2002). Poor decisions may have high consequences for mission safety and success, as noted by the Committee on Space Biology and Medicine of the National Research Council (1998): “The history of space explorations has seen many instances of poor interpersonal relations and *faulty decision making* [emphasis added].” While no major accidents have resulted directly from crew decision-making during a space mission, they have in aviation (NTSB, 1994). Of all types of crew errors observed during commercial flights, Klinect, Wilhelm, and Helmreich (1999) found that decision errors were the least frequent but the most likely to result in reductions in flight safety.

5.8.2.2.1 Dynamic Decision-Making

An element of collaborative performance that is especially important in the high-risk environment of exploration missions is the need for effective dynamic decision-making. All decisions in complex dynamic environments involve two primary components: assessing the situation and choosing a course of action to manage the outcomes (Brehmer & Allard, 1991).

- *Situation assessment* involves detecting cues in the environment, understanding their meaning, and projecting how the situation will develop in the future (Endsley, 1995). Understanding the nature of the problem also includes assessing the level of threat associated with it and determining the amount of time available for dealing with it. Available time and cue diagnosticity are major determinants of subsequent strategies (Fischer, Orasanu, & Wich, 1995). If risk is high and time is limited, action may be taken to “safe” the situation without a thorough understanding of the problem. If possible, crews take steps to create additional time to diagnose the problem (Orasanu & Strauch, 1994).
- Once the condition is assessed, a *course of action* is chosen based on goals and situational constraints. Three types of responses have been identified in many engineered domains (Orasanu & Fischer, 1997; Rasmussen, 1985³):
 - *Rule-based* – A specific response is prescribed in procedure manuals, to be applied when a particular condition is determined to exist.
 - *Choice* – Multiple options exist, one of which must be selected on the basis of goals, risks, constraints, and anticipated outcomes.
 - *Creative* – On some occasions, no response is readily available and the crew needs to invent a course of action; this type is more properly considered creative problem-solving than decision-making.

³Rasmussen’s (1985) typology involved skill-based, rule-based, and knowledge-based decisions.

5.8.2.2.2 The Role of Expertise

Experts in many high-risk domains (e.g., firefighting, military, medicine), operating under time constraints and stress, have been found to make decisions in ways that seem to be intuitive or heuristic (Klein, 1989, 1998, 2004). Without going through an analytical and exhaustive option comparison process, skilled decision-makers recognize situations as examples of a particular type and quickly generate a response. Klein (1989) calls this “recognition-primed” decision-making (RPD). If the first response generated meets the goals and constraints of the situation, no further options are considered (called “satisficing”). This initial course of action is frequently appropriate because experts’ experience provides prototypes or condition-action rules (Klein, 1993; Lipshitz, Klein, Orasanu, & Salas, 2001). If the situation or the likely outcome is not clear, additional situation assessment and mental simulation of alternatives are necessary (Klein, 1998).

An important component of expert decision-making is risk assessment. This applies to the risks associated with events or off-nominal conditions and their possible consequences, as well as to the consequences that may result from various courses of action (Brehmer, 1994; O’Hare, 1990; Orasanu, Fischer, & Davison, 2004; Yates & Stone, 1992). A study of experienced commercial airline pilots indicated that decisions in dynamic, ambiguous conditions typically are made to avoid or mitigate perceived risks (Fischer, Orasanu, & Davison, 2003). If perceived risk exceeded the pilot’s comfort zone, then a conservative or risk-averse option was chosen. But if pilots judged risk to be less serious, they usually continued with the original plan of action, but modified it to account for the threat. Consideration of worst-case outcomes is most important when action is irreversible. Explicit discussion of worst cases is helpful to draw upon diverse perspectives among distributed team members when the situation is highly uncertain and no single “correct” solution is prescribed. However, team members with different kinds of expertise may interpret information differently, leading to different decisions, as shown in several studies of pilots and air traffic controllers (Bearman et al., 2005; Davison & Orasanu, 1999). Negotiating these differences is essential for successful collaborative decision-making.

5.8.2.3 Metacognitive Strategies

Metacognitive skill refers to an individual’s awareness of her/himself as a thinker in relation to the demands of a situation: what needs to be done, what resources are required, and what capabilities are available to manage the situation (Means, Salas, Crandall, & Jacobs, 1993). It includes assessing one’s own knowledge or understanding of a problem, as well as workload, stress level, and availability. This skill enables a crew to assess its own resources in an emergency and take appropriate actions.

Metacognitive skills are essential for recognizing and managing the increased workload posed by unfamiliar or nonprocedural problems. Captains in higher performing crews in full-mission simulated flights turned over the job of flying the plane to the first officer so they could deal with the complex problem; they recognized that making decisions requires mental capacity and time for gathering and evaluating problem-relevant information (Orasanu, 1994). Crew strategies that have proven to be effective in dynamic ill-structured situations include

- Update goals and reassess priorities
- Take actions that “buy time” to gather decision-relevant information and evaluate options
- On the basis of assessment of anticipated workload, shift non-time-critical activities to low-workload periods, freeing more time for high-workload tasks
- Recognize the need to call on other resources in the crew or on the ground

Cohen, Freeman, and Wolf (1996) demonstrated that military teams can be taught a “recognitional-metacognitive” strategy for decision-making in complex ill-structured situations. This strategy combines elements of Klein’s recognition-primed decision process with metacognitive elements.

5.8.2.4 Adaptive Coordination Skills

Metacognitive skills and shared mental models are essential for maintaining adaptive team coordination. Adaptive coordination has two primary components:

- Recognizing changes in environmental conditions, team member states, or task demands
- Adjusting strategies or plans to satisfy the team’s goals in the face of these changes (Burke, Stagl, Salas, Pierce, & Kendall, 2006)

Under high workload, time pressure, stress, and fatigue, individual team members may become overloaded and prone to error (Hancock & Desmond, 2001). To ensure that team goals are met under these conditions, it is important for team members to monitor each other for cues indicating overload, stress, or errors, and to shift task responsibilities or provide assistance as needed. When workload is high, communication further increases task load. An optimal strategy for managing high workload is for team members to rely on their shared mental models of the task, team goals, and individual team-member responsibilities and capabilities. These enable team members to anticipate their teammates’ information needs and provide the information without being asked for it (Entin & Serfaty, 1999; LaPorte & Consolini, 1991; Serfaty & Entin, 1997), which is a form of implicit coordination. In a flight simulation study, effective crews used down time to prepare for upcoming events and thus talked less during a high-workload abnormal flight phase, communicating only what was essential to maintain team situation awareness, whereas less effective crews talked more (Orasanu & Fischer, 1992), a finding confirmed by Rasker (2002) using a firefighting simulation.

Several team-training techniques support development of adaptive coordination skills (e.g., Entin & Serfaty, 1999), which will be described in section 5.8.4.2.

5.8.2.5 Team Communication

Team communication is the vehicle through which adaptive coordination and collaboration take place. Communication also maintains team cohesion and supports the psychosocial well-being of the team. Effective crew communication is especially important to ensure shared situation models and to facilitate collaborative efforts, especially in dynamic, ill-structured situations under heavy workload and time pressure (Helmreich & Sexton, 2004; Orasanu & Fischer, 1992). The following features characterize the communication of effective teams in numerous environments:

Explicitness. Effective crews in many complex high-risk environments (e.g., aviation, military, nuclear power) were found to use explicit and efficient language to generate shared situation models (Orasanu, 1994). Effective crews shared more task-critical information than less effective crews, especially concerning the problem at hand, task goals, and team strategies (Bowers, Jentsch, Salas, & Braun, 1998; Orasanu & Fischer, 1992; Sexton & Helmreich, 2000). Moreover, members of effective teams anticipated each other’s information needs and volunteered information and assistance (Serfaty, Entin, & Volpe, 1993).

Feedback. Communication efficiency is evident in what Kanki, Lozito, and Foushee (1989) called “closed-loop” communication: Respondents close the conversational loop by acknowledging or answering the initiating utterance, even if only with an “uh huh.” The reply lets the initial speaker know that the utterance was heard and, hopefully, understood. If there is no reply, the speaker’s cognitive

burden is increased by wondering if the utterance was heard, which may lead to repetition, further reducing communication efficiency.

Crew-Oriented Error Correction. Effective error-correction strategies enable crews to successfully address problem situations while maintaining a positive crew climate. A documented contributing risk factor to many commercial aviation accidents is the “monitoring and challenging” error, in which one crewmember, usually a junior one, is unable to get the other crewmember to take action to resolve an important safety issue (NTSB, 1994). If one crewmember has made an error, calling it to their attention may involve a direct challenge to their status, judgment, or skill.

A study in which commercial airline pilots were asked to rate the effectiveness and directness of communication strategies in threatening scenarios revealed that both captains and first officers favored crew obligation statements (such as “We need to deviate right about now”), preference statements (e.g., “I think it would be wise to turn left”), and hints (e.g., “That return at 25 miles looks mean”; Fischer & Orasanu, 2000b; Fischer, Rinehart, & Orasanu, 2001). Common to these strategies is that they address a problem without disrupting the team climate. Also, requests that were supported by problem or goal statements (e.g., “We need to bump the airspeed to Vref plus 15. There’s windshear ahead.”) were rated as more effective than communications without supporting statements (i.e., the first sentence alone in the airspeed example), presumably because the supporting statements contributed to a shared problem model and reduced the addressee’s cognitive load by clarifying the rationale behind the request.

Relational Communication. Communication not only supports crew coordination and collaboration; it also carries relational meaning, which creates the social context for joint task work (Ginnett, 1993; Keyton, 1999). Superior task performance was found to be related to symmetric and inclusive team interactions a high degree of team member responsiveness, collaboration, agreement, and positive affect (Fischer, McDonnell, & Orasanu, 2007).

Briefings. Crew briefings are an effective way to establish crew climate and to define norms for interactions and collaboration among crewmembers. Briefings can set the stage for how crewmembers interact with each other and especially for how they manage difficult situations (Ginnett, 1987). Briefings can establish common goals, invite free and open communication, set the tone for safety, and create positive crew climate—not just by talk, but also by modeling.

5.8.2.6 Cohesion

Festinger (1950) defined group cohesiveness as “the resultant forces which are acting on the members to stay in a group” (p. 274). Aspects of cohesion that have been studied include work satisfaction, commitment to group goals, interpersonal attraction, and group identification. Cohesion arising from common response to a challenge has been termed *task cohesion*. It is defined as “shared commitment among members to achieve a goal that requires the collective efforts of the group” (MacCoun, 1993, p. 291). A second type of cohesion is *social cohesion*, the extent to which team members “like each other, prefer to spend social time together, enjoy each other’s company, and feel emotionally close to one another.” Clearly, both types of cohesion are relevant to exploration missions. Cohesion is typically measured by members rating their team on the degree of attraction they feel to the team, using instruments such as the Group Environment Scale (Moos & Humphrey, 1974) or the Group Environment Questionnaire (Carron, Widmeyer, & Brawley, 1985).

In a recent meta-analysis, Beal (2003) found a small population correlation ($\rho = .17$) between team cohesion and performance (47 studies, 2,125 teams). However, he did not differentiate between teams in field and laboratory settings. Mullen and Copper (1994) did so and found a higher cohesion-performance relationship with teams in field settings ($\rho = .27$) than in lab settings ($\rho = .17$). The highest correlation between team performance and cohesion was with sports teams ($\rho = .60$; Carron,

Coman, Wheeler, & Stevens, 2002; Mullen & Copper, 1994), followed by military teams ($\rho = .33$ from 16 studies, 577 teams; Oliver, Harman, Hoover, Hayes, & Pandhi, 2000).

Beal differentiated between task cohesion and social cohesion as predictors of team performance. He found a stronger population correlation ($\rho = .27$) between task cohesion and team performance (25 studies, 1,187 teams) than between social cohesion and team performance ($\rho = .14$, 11 studies, 342 teams).

Recent analyses suggest that high performance is both the result and the antecedent of high cohesion. In an attempt to determine the causal effects of performance on cohesion and vice versa, Carron et al. (2002) separated studies on sports teams into those that measured cohesion first—before measuring performance—and those that measured cohesion second—after performance. Correlations were high in both directions: $\rho = .57$ and $.69$ respectively. (These correlations were not significantly different from each other.) In an earlier meta-analysis, Mullen and Copper (1994) found more support for high performance causing cohesion than the reverse. In general, cohesive teams have been shown to engage in more effective team behaviors. Beal (2003, p. 991) states that “Although the temporal placement of cohesion in this causal process is uncertain, researchers have found cohesive groups to have increased efficiency of language behavior (Mickelson & Campbell, 1975), greater team mental model convergence (Mathieu, Heffner, Goodwin, Salas, & Cannon-Bowers, 2000), and greater use of transactive memory systems (Hollingshead, 1998, 2000; Wegner, Erber, & Raymond, 1991).”

In addition to its relation to performance, team cohesion also increases resilience to stress and trauma. Norwegian sailors who experienced accidents at sea but were members of highly cohesive units experienced reduced levels of post-traumatic stress disorder relative to those in less cohesive units (Eid & Johnsen, 2002). Similarly, family cohesion helped children adjust to cancer treatments; in contrast, family conflict served as a direct risk factor, adversely affecting adjustment after treatments (Phipps & Mulhern, 1995).

5.8.3 Challenges to Effective Teamwork

Numerous factors present during space missions will have the potential to disrupt effective teamwork and negatively affect team performance. Some of these factors are inherent in the space environment, while others are found in the social and organizational dynamics in any work environment. Negative consequences of the social and organizational factors may be exacerbated by isolation and confinement, especially during lengthy missions. Consequences may be manifest in emotional, psychosocial, cognitive, and team interaction functions. A host of environmental, operational, organizational, and psychosocial stressors may have an impact on the crew, influencing both individual adjustment and team performance.

5.8.3.1 Stressors in Space

Poor adaptation to space stressors has resulted in a number of performance-related effects that could compromise a crew's ability to function, especially under abnormal or emergency conditions (Harrison, 2001; Shepanek, 2005). After his experience on board the Russian orbiter *Mir*, U.S. astronaut John Blaha commented that he never anticipated the situation would be so stressful—or that it would interfere so much with his performance (Burrough, 1998). Psychosocial factors, “such as isolation, confinement, and workload, can become significant triggers or sources of stress; and these space flight stressors paired with traditional life stressors likely have an exponential impact on behavioral health for long duration astronauts” (Kanas & Manzey, 2008, as cited in Kanas, 2009). “There is considerable anecdotal and behavioral evidence that many crewmembers have experienced psychological and interpersonal difficulties arising from the myriad stressors inherent in space missions, especially those involving

longer durations” (Shayler, 2000, as cited in Kanas, 2009). Evidence from isolated and confined environments, including space, indicates that “intra-crew tension, leadership styles, and group dynamics are key factors responsible for exacerbating or ameliorating stress, or facilitating coping and adaptation” (Kanas & Manzey, 2008; Sandal, Værnes, & Ursin, 1995; as cited in Slack, Shea, Leveton, Whitmire, & Schmidt, 2008).

Space crews will be exposed to both chronic and acute stressors:

- *Chronic space stressors* include noise, weightlessness, poor sleep, circadian desynchrony, monotony, and absence of family and friends, in addition to the ever-present dangers of working in a hostile environment.
- *Acute stressors* such as high workload, time pressure, imminent danger, fatigue, and inadequate or ambiguous information are common to many high-risk work environments including space.

Stressors that represent potential risks to safe and productive space missions include team conflict, social pressures, organizational factors, cultural diversity, and sleep and circadian factors.

5.8.3.1.1 Team Conflict

Team conflict is a risk factor for long-duration space missions because of its potential impact on team-member satisfaction, team cohesion, and performance. Although *relationship* conflict is acknowledged to be dysfunctional, some management courses suggest that *task* conflict may be productive.⁴ However, a meta-analysis by De Dreu and Weingart (2003) showed that *both* relationship conflict and task conflict led to lower performance and satisfaction in groups, as shown in Table 5.8.1. Moreover, conflict degrades team performance more strongly on complex tasks involving decision-making than on less complex tasks such as production (De Dreu & Weingart, 2003). Given that astronaut tasks often involve decision-making, crew performance could be expected to be even more adversely affected by conflict in both task and relationship areas than indicated in Table 5.8-1.

Table 5.8-1 Task and Relationship Conflict Correlated with Team Member Satisfaction and Team Performance in a 2003 Meta-Analysis

	Task Conflict	Relationship Conflict
Team Performance	-0.23	-0.22
Team Member Satisfaction	-0.32	-0.54

From De Dreu & Weingart, 2003.

5.8.3.1.2 Social Pressures

Social factors may depress team performance by interfering with rational evaluation of problems or by inhibiting contributions to collaborative decision-making. Team members may feel pressured—directly or indirectly—to take a particular action (Orasanu et al., 2002). The influence may be subtle: knowing that others in the same circumstances have taken a particular course of action may induce a decision-

⁴ Task and relationship conflict are sometimes assessed with a scale developed by Jehn (1994, 1995). Task conflict reflects disagreement about the task; relationship conflict taps into team friction, personality clashes, and emotional conflict.

maker to choose it (Paletz, Bearman, Orasanu, & Holbrook, under review). An example would be pilots deciding to take off or land in marginal weather because other pilots before them have done so. Maintaining one's own reputation or self-concept as a competent professional also falls into this category (Paletz et al., under review). In addition, wanting to be agreeable and similar to others may compromise decision-making, as documented in the "groupthink" literature, when social harmony goals trump good judgment (Janis, 1982). In aviation, social factors have been implicated in accidents when a pilot has been unwilling or unable to correct an error by another pilot (Berman, 1995; NTSB, 1994)

5.8.3.1.3 Organizational Factors

Organizational factors that influence team performance include pressure to conserve resources, to meet a particular schedule, or to achieve a productivity target. These pressures may induce the crew to take greater risks than prudent or to cut corners. Organizational decisions may result in personnel schedules that induce fatigue, or inadequate documentation, training, or procedures (Reason, 1997). These factors may reduce cognitive preparedness and alertness, or interfere with the crew's ability to gather information and evaluate options to make good decisions.

5.8.3.1.4 Cultural Diversity

Experience with the Russian and American joint space programs demonstrates that cultural misunderstandings within multinational crews can lead to interpersonal tension, low productivity, and mission difficulties for both space and ground personnel (Holland, 1997b; Holland, 1998; Santy, Holland, Looper, & Marcondes-North, 1992).

Cultural issues may affect team functioning in several ways (Kanas, 2009):

- Differences in styles of coping with stress can be more complicated in multicultural crews because characteristics, such as emotional expressivity, that are common in some cultures may be unusual in others.
- Mental health issues may manifest differently in different cultures (e.g., depressed mood may co-occur with anxiety for Americans but with fatigue for Russians; Ritsher, Kanas, Gushin, & Saylor, 2007).
- Cognitive styles, decision-making styles, and individual behavior (e.g., privacy expectations, personal grooming habits) may vary by culture.
- Cultural differences in social behavior norms (e.g., how hosts treat guests, whether socializing together is expected at mealtime) can cause tension and affect cohesion during missions (Kozerenko, Gushin, Sled, Efimov, & Pystinnikova, 1999).

Living and working with members of other cultures can be stressful. It is thus critical that crewmembers appreciate the cultural basis of differences in their cognitions and behavior, and perceive diversity as an asset rather than a threat to team functioning.

5.8.3.1.4.1 The Impact of Culture on Cognition and Behavior

Fundamental values differ among cultures, shape how members of cultural groups think and behave, and affect team functioning and performance. The most pervasive difference between cultures, most notably between North America and Western Europe on the one hand, and Asian and Eastern European societies on the other, concerns the extent to which they are characterized by an individualistic as opposed to a collectivistic orientation (Hofstede, 1980; Hui & Triandis, 1986). Individualism-collectivism relates not

only to different notions of personhood, motives and intentions of behavior, and norms of interaction, but has also been associated with distinct cognitive processes.

The following highlights differences between individualistic and collectivistic cultures in people's perceptions, categorizations, deductive reasoning, and behavior:

- *Field-dependent vs. field-independent perception.* As members of an individualistic culture, North American participants were found to focus on a central object to the exclusion of its context, while Asian participants, representing collectivistic cultures, showed a preference for a field-dependent cognitive style; i.e., they attended to the relationships between objects (Kitayama, Duffy, Kawamura, & Larsen, 2003; Masuda & Nisbett, 2001).
- *Rule-following.* North Americans were likely to emphasize analysis and formal rules (Nisbett, Peng, Choi, & Norenzayan, 2001). When conflicting information was presented, North Americans were more likely to magnify differences between options for better analysis, while intuitions that were inconsistent with formal rules were pushed aside. Asian participants, in contrast, favored intuitive strategies and tended to look for a compromise solution that would accommodate contradictory information (Norenzayan, Smith, Kim, & Nisbett, 2002; Peng & Nisbett, 1999).
- *Independent vs. interdependent self.* Individualistic cultures encourage their members to assert their autonomy, to demonstrate their uniqueness, and to get ahead. Accordingly, by stressing the self, personal choices, and achievements, cultural individualism is associated with a conversational style that is explicit, unambiguous, brief, goal-directed, and first-person oriented (Gyudykunst & Ting-Toomey, 1988). Individuals are assertive, saying what they mean and what they want (Thompson & Klopff, 1991). Disagreement is voiced and discourse may be adversarial, with parties presenting arguments to prove the correctness of their views (Markus & Lin, 1999). This conversational style is fairly typical in the U.S., at least for males. Female discourse, on the other hand, is believed to share features with a conversational style prevalent in collectivistic cultures (Gilligan, 1985; Tannen, 1990). However, research on request strategies by cockpit crews found that female captains were as direct as their male counterparts (Fischer & Orasanu, 1999).

Collectivist cultures expect their members to honor social relationships, to fit in, and to benefit group goals (Markus & Kitayama, 1991). For instance, Russians, compared to North Americans, were found to “have a more interdependent sense of self, greater context-sensitivity, a stronger focus on group-enhancing goals, and a stronger focus on avoiding negative outcomes rather than achieving positive outcomes” (Ritscher, 2005). As a result, members of collectivist cultures emphasize cooperation in their interactions and favor indirect communication strategies that conceal their true intentions, wants, and goals (Gyudykunst & Ting-Toomey, 1988; Wagner, 1995). Talk is role-centered, and emotions, especially negative ones, are expressed only indirectly, if at all. In situations of interpersonal conflict, members of collectivistic cultures are likely to avoid a contentious issue or to withdraw from the situation to protect the relationship. North Americans, in contrast, are likely to address their disagreement directly and to look for solutions that satisfy not only their own but also the other party's goals (Ohbuchi & Takahashi, 1994).

- *Power distance.* Cultures differ in the extent to which social relationships are based on hierarchical structures, roles, and obligations, or build on equality and social justice (Hofstede, 1980). While power distance influences the communication strategies of members in both individualistic and collectivistic cultures (Fisher, 1984; Linde, 1988; Maynard, 1991; Mehan,

1985), status effects are more pronounced in collectivistic cultures (Holtgraves & Yang, 1992). Similarly, gender roles are more strongly defined in collectivistic than in individualistic cultures. However, differences in sex role differentiation also occur *within* individualistic cultures. Several studies report that sex roles are more differentiated in the U.S. than in Western European countries (Salamon, 1977; Ting-Toomey, 1987; Tomeh & Gallant, 1984). For instance, Ting-Toomey (1987) observed gender-specific self-disclosure and conflict style patterns in the U.S. but not in France.

- *Teamwork.* Pilots from individualistic cultures exhibited more instances of effective team behaviors (as defined by effective U.S. crews), such as assertiveness by subordinates and closed-loop communications. Pilots from individualistic cultures also expressed strong preference for leaders who are consultative and expect junior crewmembers to contribute to team decision-making (Helmreich & Merritt, 1998). Pilots from non-Anglo cultures, in particular from Asia and Russia, indicated a preference for leaders who are authoritative, take command of the aircraft in emergencies, and tell other crewmembers exactly what to do.

5.8.3.1.4.2 Effects of Cultural Diversity on Team Performance

Cultural diversity in teams may enhance team performance when team members appreciate and capitalize on their diverse perspectives. However, it also brings the potential for miscommunication, stereotyping, and debilitating conflict, especially if team members have strong attitude and value differences.

Most research on diversity in teams does not explicitly investigate cultural diversity, but focuses instead on the effects of deep-level diversity (in team members' attitudes, values, and beliefs) as opposed to surface-level differences (e.g., team members' ethnicity, gender, and age) or functional differences (e.g., team members' education, expertise, or experience; see also chapter 15 in the NASA Human Research Program Evidence Book, 2008, for a related literature review). Both positive and negative effects of diversity on team processes and performance have been reported (Jackson, Joshi, & Erhardt, 2003; Mannix & Neale, 2005). One factor moderating the diversity-outcome relation pertains to the nature of diversity. Research in both classroom and professional settings indicates that deep-level diversity is associated with relationship conflict and low team cohesion, which in turn impairs team productivity (Harrison, Price, Gavin, & Florey, 2002; Jehn, Northcraft, & Neale, 1999). For instance, a survey of U.S. astronauts who had flown on a Shuttle mission with one international crewmember revealed an average of five incidents involving miscommunication, misunderstanding, and interpersonal conflict. Moreover, 57% of these incidents were rated as having had a moderate or high impact on the mission (Santy, 1993; Santy, Holland, Looper, Marcondes-North, 1993).

Research also shows that the negative impact of attitude and value differences increases over time. This is in contrast to surface differences, such as age, gender, ethnicity, and marital status, whose effects disappeared by the later phases of teamwork (Harrison et al., 2002). Fundamental differences between team members may thus threaten team functioning when collaborations extend over a period of time, such as long-duration space missions.

In contrast to deep-level diversity, functional diversity was found to boost team effectiveness (Horowitz & Horowitz, 2007), especially for complex, nonroutine tasks (Jehn, Northcraft, & Neale, 1999). In these task contexts, diverse opinions, attitudes, and perspectives fostered more thorough examination of the problem (Mannix & Neale, 2005) and led to more novel, complex, and integrative approaches (Antonio et al., 2004). While informational diversity (i.e., lower shared knowledge) increased team conflict, these instances were disagreements about ideas rather than relationships and led to superior team performance

(Jehn et al., 1999). On the other hand, high levels of task conflict may increase the workload of team members and thus interfere with their task performance (De Dreu & Weingart, 2003).

For any type of diversity to enhance team performance, team members need to appreciate it as an opportunity and make a conscious effort to use it constructively in their joint work (Bunderson & Sutcliffe, 2002; Shaw & Barrett-Power, 1998; Van Knippenberg, De Dreu, & Hofman, 2004; van Knippenberg, van Knippenberg, & van Dijk, 2000; Watson, Kumar, & Michaelsen, 1993). Interpersonal leadership, conflict-management strategies, and team-oriented behavior were found to reduce the likelihood of relational conflict and help teams to overcome initial task process and communication difficulties (Mohammed & Angell, 2004; Watson, BarNit, & Pavur, 2005; Watson, Johnson, & Zgourides, 2002).

Also, it is important for diverse teams to have a unifying theme that transcends differences between team members (Mannix & Neale, 2005). If a culturally diverse team develops its own team culture—a “hybrid culture”—with a common identity, shared norms for interpersonal interactions, and high team performance expectations, then team success is likely to follow (Earley & Mosakowski, 2000). When a heterogeneous team is pulled together by a common goal, increased task-focused communication occurs, which leads to improved performance and increased team-member satisfaction (Schippers, den Hartog, Koopman, & Wienk, 2003). However, if differences are salient to team members, team social integration is low and team performance is likely to be impaired (Harrison et al., 2002).

5.8.3.1.5 Sleep and Circadian Factors

Research on the effects of sleep deprivation have found that sleep-deprived subjects “performed considerably worse on motor tasks, cognitive tasks, and measures of mood than non-sleep-deprived subjects,” with multiple days of partial sleep deprivation (i.e., chronic sleep loss) showing the greatest impact on cognitive performance (Pilcher & Huffcutt, 1996, as cited in Whitmire et al., 2008). Sleep debt has been found to accrue in less than a week when sleep is restricted to 4 to 6 hours per night, which is common in space crews, and performance deficits “reach levels of serious impairment” (Dinges et al., 1997, as cited in Whitmire et al., 2008). Reports from *Mir* indicate that many participants on missions lasting over six months “developed symptoms of fatigue, irritability, and minor disorders of attention and memory” (Boyd, 2001; Kanas et al., 2001; as cited in Schmidt, Keeton, Slack, Leveton, & Shea, 2008).

Likewise, sleep deprivation has been linked to behaviors that may compromise team interactions and performance. These include increased outward expression of hostility, a greater tendency to blame others, and less willingness to alleviate conflict by accepting blame, suggesting that sleep deprivation weakens the inhibition of aggression and the willingness to act in ways that facilitate effective social interaction (Kahn-Greenea, Lipizzia, Conrada, Kamimoria, & Killgore, 2006).

5.8.3.2 Stress Effects on Teamwork and Performance

Team coordination, collaboration, and performance may be affected both directly and indirectly by space stressors. Indirect effects arise from reduced levels of individual cognitive functioning or emotional adjustment, which then require other crewmembers to compensate. Direct effects on teamwork arise from disruptions to team communication or loss of team orientation. Exposure to chronic and acute stressors may be manifest in crewmember cognitive dysfunctions, psychosocial adjustment, and communication problems.

5.8.3.2.1 Cognitive Effects

Cognitive changes associated with stress occur at the individual level, but may have repercussions on team performance. The literature on stress and performance is vast and beyond the scope of this chapter,⁵ but several relevant findings stand out: Time stress typically increases errors (Hockey, 1986; Mandler, 1982; Wallace, Anderson, & Schneiderman, 1993); psychosocial and other stressors reduce voluntary control of attentional focus (Connor, Egeth, & Yantis, 2004; Liston, McEwen, & Casey, 2009; Yantis, 2008), leading to “tunnel vision” (Easterbrook, 1959); and social stress reduces working memory capacity (but facilitates implicit memory for negative emotional material) (Luethi, Meier, & Sandi, 2009). Several outcomes may influence collaborative team efforts, such as loss of situation awareness (Janis, 1982), the tendency to choose strategies that involve less effort (Edland & Svenson, 1993; Payne, Bettman, & Johnson, 1988), nonsystematic information scanning and premature closure (Keinan, 1987, 1988), decreased creativity and problem-solving (Shanteau & Dino, 1983), and greater risk-taking (Harrison & Horne, 2000).

The greatest stress on individuals often arises from situations in which perceived demands exceed their ability to cope (Harrison, 2001; Shepanek, 2005). These conditions are likely to result in perceived lack of control, which increases stress levels even further (Lazarus & Folkman, 1984; Stokes & Kite, 1994).

Situations most vulnerable to stress are those that require shifting attention due to dynamic conditions and that impose heavy working memory loads, such as evaluating alternative hypotheses or courses of action (Orasanu, 1997). These situations tend to be ones that are unfamiliar or for which cues are ambiguous, thus requiring information search or diagnostic strategies. In unfamiliar or ambiguous situations, multiple goals and hypotheses have to be integrated and evaluated, so demands on working memory, and therefore cognitive processing, will be greater.

5.8.3.2.2 Psychosocial Effects

Crewmembers’ ability to identify causes of interpersonal tensions and to respond constructively to them will be essential to survival under the hostile conditions of space. Psychosocial factors have resulted in early termination of several space flight missions (Cooper, 1976; Clark, 2007; Slack et al., 2008). Team psychosocial problems that have been reported from extended-duration missions include hostility toward other crewmembers or ground personnel, social withdrawal, increased need for privacy, and interpersonal friction (Flynn, 2005; Shepanek, 2005; Kanas & Manzey, 2003). Some consider interpersonal issues to be the limiting factor in long-duration space missions. Dr. Oleg Gazenko, medical director of the Soviet and Russian space programs, noted that “The limitations of life in space are not medical but psychological” (Oberg & Oberg, 1986).

5.8.3.2.3 Communication Effects

Team members may experience difficulty communicating when stressed or sleep-deprived. Both production and comprehension of language may be affected. While acoustical and phonetic changes such as pitch, amplitude, vibration, and voice onset time may be good indicators of stress (Stokes & Kite, 1994), they may not affect team communication as much as changes in lexical or content aspects of communication. For example, when stressed, speakers may revert to clichés or other imprecise abbreviated expressions (Cushing, 1994; Davison & Fischer, 2003). Sleep deprivation and stress lead to less explicit communication, such as use of exophoric (e.g., “this,” “that”) or generic pronouns (“it”) in place of specific nouns, thereby placing a greater burden on addressees (Harrison & Horne, 1997;

⁵ Recent reviews include Driskell & Salas (1996); Hammond (2000); Hancock and Desmond (2001); Matthews, Davies, Westerman, & Stammers (2000); and Sandi & Pinelo-Nava (2007).

Stokes, Pharmer, & Kite, 1997; Tilley & Warren, 1984). In simulated military operations after 36 hours of sleep deprivation, team members requested less information and engaged in less discussion of strategy regarding movement of assets or coordination of team actions than when they were rested (Harville, Barnes, & Elliott, 2004). The frequency of some communication behaviors, such as issuing orders, declined with increasing hours of sleep deprivation.

Language comprehension ability may also be impaired under stress, due to distraction, so they are not “listening up,” or to more fundamental cognitive processes (Lieberman, Morey, Hochstadt, Larson, & Mather, 2005; Pilcher et al., 2007).

Additionally, sleep deprivation degrades mood, which can have a negative impact on morale and thereby on effective crew communication (Dinges et al., 1997). Stress and fatigue may also cause team members to narrow their focus from the team to themselves, further disrupting communication and collaboration activities (Driskell, Salas, & Johnston, 1999).

5.8.4 Supporting Effective Teamwork

This section addresses four strategies for overcoming the challenges to effective team performance described in 5.8.3. These include composing crews for optimal performance, training crews in the skills needed to ensure effective coordination and collaboration under challenging conditions, monitoring team dynamics, and designing information and communication systems that support collaboration.

5.8.4.1 Composing Crews

Highly skilled individuals do not always perform well as a team, as indicated by problems in past missions (Burrough, 1998; Kanas & Manzey, 2003; Shepanek, 2005). “Probably the most important issue of long-term space flight with respect to the human element is that of compatibility” (Putnam, 2005). Consideration of team composition and performance factors will be especially important for longer-duration missions and will be reviewed in this section.⁶

5.8.4.1.1 Team Member Characteristics and Skills

Teams perform better when composed of individuals who have a high general mental ability (GMA), according to three meta-analyses (Bell, 2007; Devine & Phillips, 2001; Stewart, 2006). Astronauts already are selected for high GMA; however, their high mental abilities and task expertise do not ensure high team performance. Bell (2007) analyzed laboratory and field studies (separately), and found only a small correlation between performance and average GMA in teams in the field (i.e., long-lasting teams)—a finding most relevant to astronaut crews.

On the other hand research suggests that team performance is superior when team members have higher-than-average planning and coordination skills and are homogeneous in this regard. Miller (2001) found a moderate correlation between performance and planning and coordination skills, as measured by the responses to a paper-and-pencil scenario test called the Teamwork Test (Stevens & Campion, 1999). These skills include “coordinating and synchronizing activities, information, and tasks between team members, as well as aiding the team in establishing individual task and role assignments that ensure the

⁶ This section refers to correlations between team characteristics and performance. Statistical correlation coefficients range from 0 (no correlation) to 1 (perfect correlation). In this section, instead of precise numbers, statistical correlations are interpreted as small, medium, and large ($r = 0$ to 0.30, 0.31 to 0.50, and 0.51 to 1.00, respectively) on the basis of rules suggested by J. Cohen (1992). All correlations reported here are statistically significant, i.e., not likely to be due to chance.

proper balance of work-load between team members” (Miller, 2001, p. 748). Some of these skills are addressed by Team Adaptation and Coordination Training (TACT), to be discussed in section 5.8.4.2.3. Since the Teamwork Test predicts team performance, it would be useful to administer it before and after training to see if training improves these scores. Schmidt et al. (2008) also cite studies demonstrating that teams composed of team members with more knowledge about teamwork perform better (Hirschfeld, Jordan, Feild, Giles, & Armenakis, 2006; Morgeson, Reider, & Camption, 2005). In a manufacturing organization, Morgeson and colleagues (2005) observed that individual knowledge about teamwork helped to predict team performance. In a field study of 92 teams (1,158 team members) in a United States Air Force officer development program, Hirschfeld and colleagues (2006) found that team members’ mastery of teamwork knowledge predicted better team task proficiency and higher observer ratings of effective teamwork (Schmidt et al., 2008, p. 14).

5.8.4.1.1 Values and Teamwork Attitudes

Teams perform better when they are composed of members who have higher scores on measures of collective orientation and who prefer to work in teams instead of working alone. Team members who have a collective orientation prefer procedures that foster harmony and solidarity (Earley & Gibson, 1998) and rate themselves as being loyal to their team and willing to sacrifice for it (Triandis, 1995). Bell (2007) found a moderate correlation between team performance and collectivism and a small correlation between team performance and measures of preferring teamwork.

5.8.4.1.2 Personality Factors

Studies indicate that high-performing teams in the field have high mean team scores on Agreeableness and Conscientiousness on the Five Factor Model Personality Test (Costa & McCrae, 1992; John & Srivastava, 1999). Table 5.8-2 shows the correlations from a recent meta-analysis (Bell, 2007).

Table 5.8-2 Relationships Between Big Five Personality Factors and Team Performance in a Recent Meta-Analysis

Big Five Personality Factor	Corrected Population Correlation with Team Performance
Agreeableness	.31
Conscientiousness	.30
Openness to experience	.20
Extraversion	.15
Emotional stability	.06

Openness to experience and extraversion were also related to team performance, but less strongly. Variability on agreeableness and conscientiousness was negatively related to team performance, meaning that the *more similar* the team members’ scores were on these two measures within each team, the better the performance. It was also found that team performance was most highly correlated (*rho* =

.37) with the minimum score of Agreeableness in the team (Bell, 2007). This indicates that one disagreeable member can disrupt the social harmony of the team and thus its performance. (See also Schmidt et al., 2008, ch. 15, p. 6 for details on earlier studies.) These findings suggest that assembling teams with members whose scores are uniformly high on agreeableness and conscientiousness can benefit team performance.

5.8.4.1.2 Group Behavioral Profile

Analyses of teams using the Group Diagramming Method (GDM; described in section 5.8.4.3.2) have identified group characteristics that lead to cohesion and high team performance. Designing teams to have these characteristics should contribute to enhanced team performance and mission success.

Recent research using GDM with commercial airline crews and crews in simulated lunar expeditions indicate that when crews perform highly structured tasks, performance is higher when the crew center of gravity⁷ is more expressive, i.e., less task-oriented and more socio-emotional (Parke, Kanki, Nord, & Bianchi, 2000, Orasanu et al., 2008). Performance is also higher when crewmembers are not polarized on the dominance dimension, i.e. when there is more equal participation (Orasanu et al., 2008). These findings indicate that it is important to have crewmembers who are able to engage in expressive behaviors such as joking and who participate equally.

5.8.4.1.3 Crew Size

Many of the studies pertinent to crew size have been with groups rather than with teams. Rasmussen (2006) reviewed the team literature for size effects on psychological outcome (e.g., member satisfaction) and finds that out of 55 studies, 20 did not report the team size, and 20 did not report the results in relation to size. The typical size was 8 to 14 members. Of those studies in which team size was examined, size was not found to affect psychological outcome measures of the team. One study in which size of teams was examined found that members of larger teams were less satisfied, participated less, and cooperated less than members of smaller teams (Guzzo, Jette, & Katzell, 1985).

Optimal group size has been found to depend on the task. An optimal size for group discussion and decision-making is around five members (Hackman & Vidmar, 1970; Hare, 1982; Hare, Blumberg, Davies, & Kent, 1994; Slater, 1958), although a comparison of three- and seven-member groups found the smaller group to be more effective in solving a social dilemma (Seijts & Latham, 2000). Clearly, astronaut crews perform numerous tasks, so studies involving only one type of task cannot help determine ideal crew size.

Although larger groups have an obvious advantage in terms of potential diversity of knowledge, skills, and resources (Levine & Moreland, 1998), smaller groups are generally more cohesive and perform better. As groups become larger, members' liking for the group decreases (e.g., Indik, 1965; Katz, 1949; Slater, 1958). Performance also decreases as groups get larger (Mullen & Baumeister, 1987; Mullen, Johnson, & Drake, 1987). Several explanations have been offered to account for these findings.

- Larger groups are likely to experience process losses (Curral, Forrester, Dawson, & West, 2001; Steiner, 1972), in particular concerning group member coordination and motivation (Cohen & Bailey, 1997; Levine & Moreland, 1998; Poulton & West, 1999; West, 1995).
- As group size increases, individual participation goes down and groups are more likely to be dominated by a few individuals (see Morgan & Lassiter, 1992, for a review).

⁷ High mean score on this dimension weighted by dominance.

- Conformity pressures rise with group size (Nemeth & Owens, 1996; Nemeth & Staw, 1989).
- Larger groups have more conflict due to variability in values, motives, and attitudes (Levine & Moreland, 1998).
- Larger groups have more difficulties in adopting innovative solutions or practices than smaller groups (Drazin & Schoonhoven, 1996).

The need for backup should also be considered when considering crew size. Single-point failures that may occur when only one individual has a skill can be catastrophic. Crew cross-training can ensure skill redundancy to prevent these single-point failures in exploration missions (Cannon-Bowers, Salas, Blickensderfer, & Bowers, 1998).

5.8.4.1.4 Gender Composition

The determination of gender composition of expedition crews should take into account both the physical and social attributes of the crewmembers required to maintain psychosocial well-being and to accomplish mission tasks that may require strength and endurance.

Recent case studies of all-male, all-female, and mixed-gender polar expeditions found that all-male groups tended to be highly competitive; all-female groups focused on interpersonal issues related to teamwork; and in mixed-gender groups, the women often took on socio-emotional maintenance roles, acting as peacemakers and confidants for the men (Leon, 2005). A meta-analysis by Wood (1987) found that all-male groups performed better than all-female groups in strictly task-oriented activities, while all-female groups performed better in socially oriented activities. In a summary of literature relevant to space missions, Bishop (2004) suggested that the presence of both men and women might serve “to normalize group behavior in ways that promote individual and group functioning” (p. C17).

Some problems can occur with mixed-gender teams, however. When the women are close in age to the men, sexual rivalries, tension, and harassment may result (Rosnet, Jurian, Cazes, & Bachelard, 2004). Culture can interact with gender roles, resulting in misunderstandings, conflicting expectations, and in some cases, serious clashes (Leon, 2005; Paletz, under review; Sandal, 2004).

Based on the experience of a three-couple Arctic ship-based expedition, it has been suggested that stable couples would be the ideal gender mix for long-duration missions because of the social and emotional support the couples could provide each other (Leon, 2005; Leon, Atlis, Ones, & Magor, 2002; Leon & Sandal, 2003). Spousal relationships and physical contact have also been shown to help adaptation to stressful conditions. For instance, Coan, Schaefer, and Davidson (2006) found, using functional magnetic resonance imaging, that spousal hand-holding attenuated neural response to threat and decreased the experience of task-related unpleasantness. They also found that the benefits of spousal hand-holding were sensitive to marital quality, suggesting that “individuals in higher-quality relationships benefit from greater regulatory effects on the neural systems supporting the brain’s stress response, including the affective component of brain processing” (Coan et al., 2006, p. 1037).

5.8.4.1.5 Command Structure and Leadership

Leadership is a crucial factor in team composition because leadership greatly affects team performance and cohesion. “Leadership concerns building cohesive and goal-oriented teams; there is a causal and definitional link between leadership and team performance” (Hogan, Curphy, & Hogan, 1994, p.493). Schmidt, Wood, and Lugg (2004) found that average leadership effectiveness scores significantly predicted team climate ratings among over 400 participants in 19 Antarctic teams.

Recent research on highly autonomous teams working on complex tasks suggests that shared leadership

involving team members, rather than just the appointed leader, enhances team performance; high-performing teams tend to exhibit more shared leadership than low-performing teams (Pearce & Sims, 2002). Shared leadership enables team members to look to members with the most knowledge and experience in given situations for guidance. These findings suggest that team performance, cohesion, and satisfaction can be enhanced by allowing leaders to emerge naturally, with the ideal of having more distributed leadership (i.e., many leaders) and a combination of male and female leaders. This does not, however, imply that the mission commander does not have full authority and responsibility for decisions.

The following are some core findings from the vast literature on leadership.

- Leadership can be divided into task-focused work and relationship-focused work (as applied to the Shuttle-*Mir* Program in Kanas & Ritscher, 2005).
- Leadership styles and effectiveness are contingent on the specific situation—the type of task, how much trust is held by followers, and so on (e.g., Fiedler, 1967; Strube & Garcia, 1981; Vroom, 2000; Vroom & Jago, 2007). For example, in self-selected tank crews, performance was high in two different situations: when cohesiveness was low and the commander style was people-oriented, and when cohesiveness was high and the commander had both a strong task- and people-orientation (Tziner & Vardi, 1982, as cited in Paletz, under review). Also, research on decision-making by business managers has found that they use more participative styles when decisions are highly significant, group commitment is needed, personal expertise is low, group expertise is high, and the group has a history of working together effectively (Vroom, 2000).
- Personality of the leader plays an important role in team performance (Hogan, Curphy, & Hogan, 1994; Hogan & Kaiser, 2005). In aviation, performance of the flight crew (measured by number and severity of errors) was significantly correlated with the captain's personality: crews with warm, friendly, self-confident captains who stood up well to pressure made the fewest errors (Chidester, Helmreich, Gregorich, & Geis, 1991). Effective leaders possess the “bright side” of the five-factor model of personality (i.e., Extraversion, Agreeableness, Conscientiousness, Emotional Stability, and Openness; Judge, Bono, Ilies, & Gerhardt, 2002). Perhaps more importantly, they do not possess dysfunctional “dark side” characteristics (e.g., narcissism), which may be hard to detect initially but which are very detrimental to teams in the long term.

Who emerges or is accepted as a leader may be influenced by demographics. For example, in groups of Caucasian and Chinese males, a Caucasian usually became the leader, even when he was in the minority. This seemed to be due to his higher rate of participation (Kelsey, 1998, as cited in Paletz, under review). Women may be less likely to emerge as leaders than men, particularly in short-term groups (Eagly & Karau, 1991). However, although men tend to exhibit more leadership behavior than women in mixed-gender groups (Craig & Sherif, 1986), women tend to attain higher levels of informal leadership status, and are “more effective than males in positively affecting team performance” (Cohen & Ledford, 1994; Neubert, 1999) when team tasks require more social interaction (Eagly & Karau, 1991). A higher number of informal female leaders within a team is significantly related to higher supervisor ratings of team performance (Neubert, 1999).

How team leaders emerge also can have an impact on team performance. Research suggests that self-managed teams are superior in performance and team-member satisfaction to teams managed by an appointed leader (Cohen & Ledford, 1994; Neubert, 1999). Group-member agreement regarding informal leadership is associated with group cohesion (Shelley, 1960) and satisfaction of group members (Heinicke & Bales, 1953). Moreover, the higher the proportion of informal leaders in a team, the more cohesive the team (Neubert, 1999). The equal communication and participation among team members

that comes with a higher ratio of informal leaders to members is associated with higher levels of team-member satisfaction (Misiolok, 2005). Recent research indicates that both vertical (appointed) and shared (emergent) leadership predict team performance; appointed leaders still play an important role in developing and maintaining shared leadership, but shared leadership is a more useful predictor of team effectiveness (Pearce & Sims, 2002). Promoting shared leadership within highly autonomous teams enables the team to benefit from the expertise of all members, while still maintaining the important leadership role and necessary chain of command of appointed leaders.

5.8.4.1.5.1 Leadership Styles

High flexibility in leadership style is necessary in conditions of rapid environmental change and innovative tasks such as those expected during long-duration space missions (Hersey, Angelini, & Carakushansky, 1982). Leadership style is a critical factor in promoting positive team climate and cohesion. Team climate and cohesion, in turn, were related to interpersonal tension and work satisfaction among Antarctic overwintering teams (Wood et al., 2005). Questionnaires provided insights into what constitutes effective leadership: “Highly regarded leaders fixed problems, united the group, rewarded desirable behaviors, and solicited feedback. Negatively rated leaders blamed others, engaged in behaviors that divided the group, punished, and ignored feedback when it was offered. One poorly regarded leader said, ‘I’m a good leader. They just don’t know how to follow’” (Wood et al., 2005, p. B29).

In a study of military leaders, the effects of different leadership styles on team cohesion and team efficacy as mediators of team performance were examined (Bass, Avolio, Jung, & Berson, 2003). Three leadership styles were compared:

- *Transactional contingent reward* leadership “builds the foundation for relationships between leaders and followers in terms of specifying expectations, clarifying responsibilities, negotiating contracts, and providing recognition and rewards for achieving expected performance” (Avolio, 1999, p. 212).
- *Transformational* leadership “enhances the development of followers, challenging them to think in ways in which they are not accustomed to thinking, inspiring them to accomplish beyond what they felt was possible, and motivating them to do so....” (Avolio, 1999, p. 215).
- *Passive-avoidant / laissez-faire* leadership “either waits for problems to arise before taking action or takes no action at all” (Bass et al., 2003, p. 208).

The strongest positive influence on both team cohesion and performance were senior leaders with transformational leadership styles (Bass et al., 2003). Team performance was partially enhanced by cohesion as well. These findings show two paths by which leadership can influence team performance—a direct one and an indirect one, through team cohesion.

A summary of research on leadership shows that personality predicts leadership style, which predicts employee attitudes and team functioning, which in turn predict performance (Hogan & Kaiser, 2005).

5.8.4.1.5.2 Leadership in Multicultural Teams

It is important that leaders of multicultural teams be aware of and sensitive to cultural differences in the team, while using their role as sense makers to build a strong team culture (Salas, Burke, Wilson-Donnelly, & Fowlkes, 2004). Team leaders may be instrumental in team-building by emphasizing commonalities and shared goals among team members (Gaertner, Mann, Murrell, & Dovidio, 1989; Schippers, den Hartog, Koopman, & Wienk, 2003) and by facilitating the formation of a “hybrid” culture (Earley & Mosakowski, 2000). Managers’ cross-cultural communication competence was found

to be positively related to team performance (Matveev & Nelson, 2004). The following are key leadership competencies in a multicultural team context (Elmuti, 2001; Matveev & Nelson, 2004; Salas et al., 2004):

- Awareness of the cultural basis of one's own and team members' perceptions and actions
- Positive attitude toward and appreciation of differences
- Social intelligence (in particular, sensitivity to verbal and nonverbal cues)
- Flexibility in resolving misunderstandings
- Ease in communicating with foreign nationals, in particular the ability to align goals, standards, and procedures with the cultural expectations of individual team members
- Basic knowledge about the country, culture, and language of team members

5.8.4.1.6 Evaluating Crew Formation

Despite the advances in research on crew composition and performance described in the preceding sections, it is important not to rely on any single method, model, or finding in trying to compose optimal crews for exploration missions. Observing composed crews over a significant period is the ultimate test of their ability to work together effectively, productively, and happily. Stuster (1996) suggests that it would be useful to conduct high-fidelity six-month simulations “as the final step in the selection process, for formal evaluation of the relevant performance of candidate crewmembers before final assignment” (p. 270). No amount of testing can predict all reactions of crewmembers to each other. For example, the physical appearance of a crewmember can remind another of a disliked teacher and influence interaction between these crewmembers in a negative and unpredictable way. Thus, observation and awareness of important aspects of human interaction should be the final criterion for crew composition. However, a number of approaches to evaluating crew composition may be useful adjuncts in both short-term and long-term simulation environments, including the GDM, Linguistic Analysis of communication, and automated measures such as those developed by Pentland (2008) for analysis of dyadic interaction.

5.8.4.2 Training to Enhance Team Performance and Cohesion

This section addresses how team coordination, collaboration, and performance can be enhanced through training. Training requirements include teamwork skills, techniques for coping with interpersonal stressors, intracrew and intercrew communication, multicultural teamwork, and conflict resolution (Stuster, 2005).

5.8.4.2.1 Current NASA Training

NASA conducts classroom training in Space Flight Resource Management (SFRM), cultural awareness for multicultural crews, and stress management. It also provides opportunities for team-building through outdoor survival training exercises using the National Outdoor Leadership School (van der Ark, personal communication, January 2005).

SFRM is based on aviation crew resource management (CRM) training and includes modules on situation awareness, decision-making, crew coordination, workload management, leadership-followership, and risk management. This instruction is done primarily through lecture and discussion, followed by practice in challenging mini-simulations with feedback. Part-task simulators are used for technical training. Integrated simulations are conducted involving the flight crew and ground crew, thereby providing an opportunity to integrate various skills needed for coordination and collaboration.

SFRM training is provided to both astronauts and flight controllers early in their training. However, no refresher training in SFRM skills is provided later in their careers after crews have been assembled for specific missions.

5.8.4.2.2 Crew Resource Management Training

The type of team training most widely adopted for use in high-risk domains such as aviation, military operations, nuclear power, and medicine is some variant of CRM. CRM training has been implemented as a way to combat stress and to ensure effective crew performance by using all available resources, both in flight and on the ground (Helmreich & Foushee, 1993).

CRM focuses on desired communication and behavioral skills identified through analyses of effective crew performance, mainly in aviation, in aspects such as decision-making, risk management, team coordination and communication, leadership-followership, and interpersonal skills (team support). The most recent generation of CRM training focuses on threat and error management (TEM; Helmreich, Klinect, & Wilhelm, 2001). Threats tend to be events in the aircraft (e.g., system malfunctions) or the environment (e.g., traffic or weather) that pose a challenge to the crew and to the mission; errors may be committed by the flight crew, by air traffic control (ATC), or by others in the system. Acknowledging that all humans are fallible and will make errors, TEM training includes error-recovery strategies in addition to error prevention.

Over the past 25 years, research has identified the importance of experience-based training. Rather than simply being told how to work together as a crew, members must have an opportunity to learn by doing in meaningful task environments (Salas, Wilson, Priest, & Guthrie, 2006). Crew-focused simulation exercises are based on realistic operational scenarios (see Wiener, Kanki, & Helmreich, 1993), creating opportunities to develop and practice crew coordination and teamwork skills integrated with technical challenges.

5.8.4.2.3 Team Adaptation and Coordination Training

Although additional research is still needed in this area, training that emphasizes crew coordination and adaptation seems to be most effective (Salas, Nichols, & Driskell, 2007). TACT (Entin, Serfaty, & Deckert, 1994) is a training intervention in which team members are trained to adjust their coordination and communication strategies to maintain successful task performance under high workload and time pressure. TACT is based on the premise that effective teams must develop shared situation models of the task environment, be sensitive and responsive to changes in task demands, and build mutual mental models of interacting team members' tasks and abilities (Serfaty, Entin, & Johnston, 1998). These shared models help to generate shared expectations for how a situation will evolve and for the needs of other team members. Team members are taught how to recognize signs of stress in themselves and others, and how to deal with the coordination and communication overhead required to keep the team organized under varying levels of stress and shifting conditions.

5.8.4.2.4 Team Cross-Training

Team cross-training (e.g., Cannon-Bowers et al., 1998) is a team-training intervention in which team members rotate positions to develop an understanding of the knowledge and skills necessary to perform the work of other team members. The technique may prove useful for NASA exploration missions, given the limited number of crewmembers and the need for skill redundancy to ensure that mission tasks will be performed even if one skilled crewmember is not available.

An evaluation of cross-training found that it was important only when team workload was high and it was necessary for tasks to be reallocated across crewmembers (Cannon-Bowers et al., 1998). Cross-

training may also contribute to implicit coordination, that is, the ability of team members to coordinate their joint efforts without the need to communicate overtly, an important skill in high-workload conditions, although the evidence on this point is inconsistent (see Rasker, 2002).

5.8.4.2.5 Team Dimensional Training

The aim of Team Dimensional Training (TDT) is to develop self-managing teams by fostering team self-diagnosis, correction, and debriefing skills, based on review of past performance (Smith-Jentsch, Zeisig, Acton, & McPherson, 1998). Four dimensions of team process are emphasized in the training: information exchange, communication, backup (supporting) behaviors, and initiative and leadership.

A recent validation of TDT found that Naval aviation command and control teams using guided team self-correction developed more accurate mental models of teamwork and demonstrated greater teamwork processes and more effective outcomes than did teams using the traditional debriefing approach, which was less participative and more linear (Smith-Jentsch, Cannon-Bowers, Tannenbaum, & Salas, 2008).

5.8.4.2.6 Interpersonal Skill Training

Central tenets of interpersonal human relations training are to increase individual awareness of individual and cultural differences (e.g., how different people see the world, their expectations, norms and roles) and to increase awareness that much group friction is based on these differences, rather than on “difficult individuals” (Kass & Kass, 1995). Interpersonal Skill Training (IST) training typically includes working with others, leadership, communication, conflict management, and team-building, all of which relate to cohesion as well as to team performance. A recent meta-analysis of the relations between various training programs and outcomes in nontechnical organizations found that IST had the largest effect on productivity gains (Arthur, Bennett, Edens, & Bell, 2003). IST also had positive effects on team cohesion, morale, and job satisfaction (Bradley, White, & Mennecke, 2003). However, training effects diminished over time without ongoing practice of these skills, an important finding for long-duration space missions (Guzzo et al., 1985).

5.8.4.2.7 Multicultural Training

Adequate training and support for multicultural teams must be implemented to prevent the difficulties that have resulted from cultural misunderstandings in previous missions. Many crewmembers have identified cross-cultural misunderstandings during space missions as causing interpersonal tension, low productivity, and mission difficulties for both space and ground personnel (Carter, Buckley, Holland, Hegel, & Greenhalgh, 2003; Holland, 1997, 1998; Santy, 1993).

Cultural differences in gender attitudes also have been problematic. Male cosmonauts have shown gender stereotyping toward their female counterparts during missions (Chaikin, 1985; Oberg, 1981; Oberg & Oberg, 1986). A cosmonaut chief has been quoted as saying that space flight is too demanding for women (Oberg, 1981).

Multicultural team training requirements include leadership, communication, and coordination strategies that aid taskwork as well as teamwork, and techniques that support teams in developing their own team culture, common identity, and shared goals and norms. In addition, team members need to value diverse perspectives. They should also be competent in one common language (Kelly & Kanas, 1992; Merritt & Helmreich, 1996), or should have conversational knowledge of most team members’ languages (Dion, 2004; Matveev & Nelson, 2004). Training approaches that emphasize behavioral competencies and provide opportunities for practice were found to be more effective than programs aimed at changing attitudes (Kealey, 2004; Kealey & Protheroe, 1996).

NASA conducts classroom training in cultural awareness for multicultural crews; however, validation of multicultural training programs is meager (Kealey, 2004). Crewmembers also participate in joint training in Russia with non-U.S. team members, but unfortunately, the amount of time the crew actually spends together in training is minimal and likely to diminish further in the future.

5.8.4.2.8 Conflict-Management Training

Given that task-related disagreements are perceived as negative by those who are involved, learning to manage task conflict is essential to both team performance and satisfaction (Bales, 1950). However, the goal should not be to eliminate disagreements, since disagreements may be essential to correct errors and to evaluate alternative perspectives on a problem, especially in high-risk situations (Orasanu & Fischer, 2008; Paletz, 2006). Crewmembers need to disagree in a way that does not aggravate the situation and to focus on ways of restoring harmony after the disagreement. Skillful ways of disagreeing include framing one's position as being motivated by a concern for crew welfare and maintaining joint responsibility for problem solution (Fischer & Orasanu, 2000b). De Dreu and Weingart (2003) recommend that team leaders, advisors, and facilitators should help the team to diagnose the types of conflict that emerge and teach team members how to manage these conflicts. Cartreine has developed a self-administered conflict-management training module for astronauts to use during space missions, which directly addresses this need (Cartreine, Buckey, Hegel, & Locke, 2009).

Regarding task conflict, De Dreu and Weingart (2003) cite research indicating that team performance may benefit, but only when team members do the following:

- Perceive cooperative rather than competitive goal interdependence (e.g., Alper, Tjosvold, & Law, 2000; for a review, see Tjosvold, 1997)
- Cultivate an environment that is open and tolerant of diverse viewpoints, and work with cooperative norms to prevent disagreements from being misinterpreted as personal attacks (Amason, 1996; De Dreu & West, 2001; Jehn, 1995; Lovelace, Shapiro, & Weingart, 2001; Simons & Peterson, 2000)
- Use more collaborative and less contentious communication when expressing disagreements (Lovelace et al., 2001)

5.8.4.2.9 Skills for Coping with Stress

The effects of stress can be mitigated and team performance improved by reducing anxiety and increasing technical skill proficiency, confidence, and team coordination skills. Crewmembers can monitor each other's efforts and be alert to cues signaling stress, overload, or fatigue (Baranski et al., 2007). One countermeasure recommended for sleep-deprived teams is to talk, which stimulates alertness (Dinges et al., 1997).

Training can improve performance directly by making knowledge more readily available and skills more automated. Training can also affect performance indirectly by increasing the crew's confidence in their ability to cope. It is typically the *perception* of threat that determines stress reactions (Hockey, 1986; Lazarus & Folkman, 1984). If a person feels confident when facing a potentially stressful situation (e.g., parachute jumping), the stress reaction is reduced (Epstein & Fenz, 1965; Fenz, 1975). Anxiety (i.e., fear of anticipated threats) can be further reduced through techniques such as stress inoculation training (SIT) (Meichenbaum, 1996, 2007). A similar technique exists for stress-reduction training in teams (Driskell, Salas, & Johnston, 2001).

An important question for *crew* training is whether training on cognitive-appraisal or stress-coping techniques can also change emotional and physiological stress responses, and thereby improve team performance. The following have been established:

- Individuals vary in their typical cognitive and emotional responses to stressors: some interpret threatening events as challenges, while others interpret those same events as threats. How a person appraises conditions can elicit qualitatively different emotional, behavioral, and physiological responses (Tomaka, Blascovich, Kelsey, & Leitten, 1993).
- Individuals also differ in their preferred coping strategies (Endler & Parker, 1990). Task-oriented coping typically is related to reduced stress and better performance than emotion-oriented, social-diversion, or distraction types of coping strategies.

5.8.4.2.10 Training for Productivity

Reduced productivity has been a problem in crews living for extended durations in isolated and confined environments such as wintering over in Antarctica or living aboard the *Mir* space station (Connors, Harrison, & Akins, 1985). The reasons for this are not fully understood. However, declining productivity among space crews can be mitigated in at least two ways—indirectly by maintaining good crew morale, cohesion, and a sense of efficacy, and more directly through work structures, schedules, and reward practices. Of 11 different types of workplace interventions, training and goal-setting were most effective in improving worker output, including both the quantity and quality of work (Guzzo et al., 1985).

Increasing productivity does not necessarily depress morale. Productivity training that involved team-building, process consultations, and management skills not only resulted in significant increases in an organization's productivity that were maintained over a year, but also resulted in significantly increased employee job satisfaction (Paul & Gross, 1981).

5.8.4.2.11 Intact vs. Remixed Teams

In environments such as the military, intact work teams are trained together in teamwork skills (Kanki & Foushee, 1989; Leedom & Simon, 1995). This process is believed to enhance the opportunity of team members to develop more robust team models based on experience with each other's strengths and limitations, as well as task roles and responsibilities (Foushee, Lauber, Baetge, & Acomb, 1986; Kanki & Foushee, 1989). In other environments such as aviation, a more common strategy is to assemble crews after members have completed teamwork training in larger groups. New teams are expected to coordinate and collaborate based on the role-based teamwork behaviors they have learned. This approach limits the opportunity to build team models involving specific team members.

The power of team familiarity was demonstrated in a study designed to assess the effects of fatigue on commercial flight crew performance. Fatigued crews who had just come off duty after three or four days flying together performed better in a challenging flight simulation than newly formed, fully rested crews (Foushee et al., 1986). This surprising finding suggests that crew familiarity acquired while the fatigued crews were flying together gave them a performance advantage sufficient to overcome the effects of fatigue. This finding is supported by a National Transportation Safety Board report (1994) that found accidents to occur disproportionately on a crew's first day flying together, before they had time to develop specific team models based on familiarity.

The question of which strategy—training intact teams or configuring teams after training—leads to more effective and robust teamwork has rarely been tested empirically. Two recent studies address this issue:

- Remixing teams of college students after training them to perform simulated unmanned aerial vehicle missions resulted in more flexible and adaptive team behaviors by disrupting established coordination patterns (Gorman et al., 2006). However, the remixing did not enhance overall team performance.
- Intact, battle-rostered Army aircrews performed no better than newly formed crews after a week of team coordination training and simulator practice (Leedom & Simon, 1995). However, the intact crews reported lower workload and greater implicit coordination, both of which are potential benefits but raised management concerns about complacency and overconfidence.

5.8.4.3 Monitoring Tools

Interpersonal friction has been noted on the *Mir*, and NASA astronauts have also reported conflict on missions (Kanas et al., 2005; Flynn, 2005; Shepanek, 2005). Difficulties between the crew and ground operations (Mission Command and Control, or MCC) have also occurred (Kanas, 2005). Interpersonal problems have been reported in long-duration analog environments as well (Stuster, Bachelard, & Suedfeld, 2000; Wood et al., 2005). Currently, the crew can get support from the flight surgeons. However, on long-duration missions, especially to Mars, ground support will not always be available. Flight surgeons have stated the need for unobtrusive monitoring tools that detect change in crew cohesion that may be precursors of crew dysfunction and poor performance (NASA Human Research Program, 2007).

Technologies are needed that are embedded or nonintrusive (i.e., do not disrupt ongoing crew activities), and that provide the crew with readily understood, actionable, diagnostic feedback. Three strategies that show promise, though they are not yet ready for implementation, are automated dyadic monitoring, group diagramming, and linguistic analysis.

5.8.4.3.1 Automated Measures of Group Interaction

Automated devices have been developed to monitor and assess some aspects of team performance and may in the future be useful in composing teams. Pentland (2004) described a wearable device that automatically records conversations between two people and analyzes (1) the extent one person is in control of the interaction (by monitoring the amount of speech and the influence on turn-taking), (2) the participants' emotional involvement (by measuring changes in voice stress), and (3) their empathic responses (by measuring frequency of backchannel and mimicking speech). These measures were found to correctly predict outcomes in dyadic interpersonal situations, such as getting a job, a raise, or a date. For instance, five minutes of role-played negotiations was sufficient to predict the objective outcome with an average decision accuracy of 70%. This tool currently monitors dyads only, but tools that monitor multiple-member team interaction may become available in the future.

5.8.4.3.2 Group Diagramming Method

There is not only a need to monitor the interaction among members of a team, but also to take into consideration the many types of team interactions that can lead to poor performance and decision-making. For example, in just a two-person team,

- Both can be viciously fighting one another.
- One person can be accusing the other of misdeeds and the other can be sulking.

- One person can be task-oriented and positive in their interaction toward someone who simply won't respond.
- One person can be overly dominant—continuously talking so that the other cannot get a word in edgewise.
- One person can be continuously joking while the other is trying to be serious.
- Both people can be continuously task-oriented and the interaction can become monotonous and boring.
- Both people can be very quiet and not interact.
- Both people can be so positive that they never give an opposing point of view.
- Both people can be continuously joking and never get down to business.

The GDM can identify and portray these interaction patterns as well as the more complex patterns that can exist in larger teams (Bales & Cohen, 1979). Examples of Group Diagrams in large groups are shown in Figure 5.8-1 below (Parke & Houben, 1985). Each circle represents one individual's rated behaviors on the two dimensions. The size of a circle represents relative dominance, with bigger circles indicating more dominant behavior. The color of a circle indicates gender—men blue, women red.

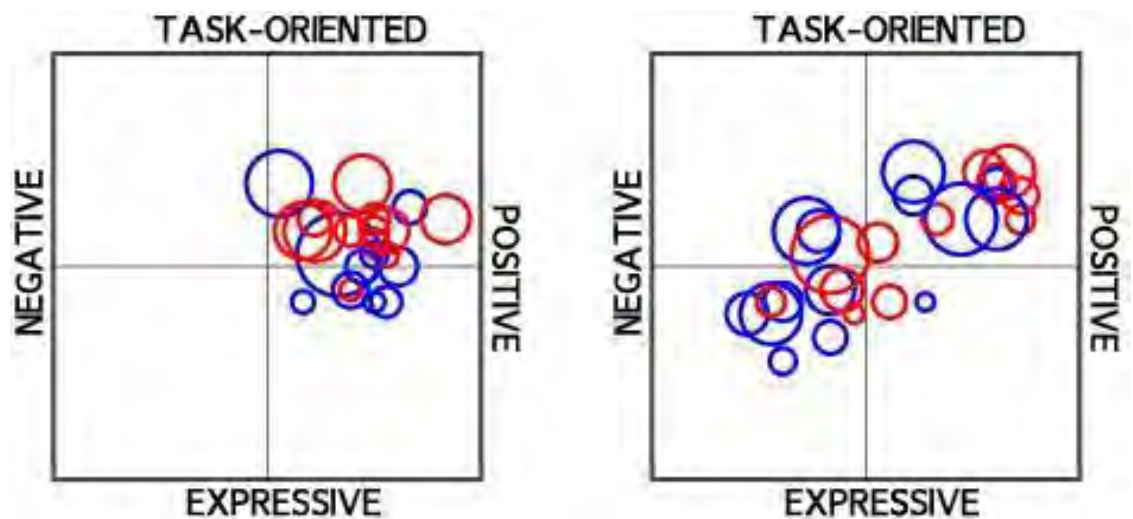


Figure 5.8-1 Group Diagrams of a unified group (left) and a polarized group (right).

This method builds on the finding that the most important dimensions of group interaction are

- Positive versus negative behaviors
- Task-oriented versus expressive behaviors
- Dominant versus submissive behaviors

(Couch, 1960; Emmerich, 1968, 1973; Isenberg & Ennis, 1981; Parke & Houben, 1985; Schaefer, 1971; Schaefer, Droppleman, & Kalverboer, 1965; Wish, D'Andrade, & Goodnow, 1980).⁸

A cohesive group in this system is represented by

- A center of gravity⁹ on the positive side of the space

⁸ A different approach involves using these three dimensions to classify values, not behaviors (Koenigs & Cowen, 1988).

⁹ High mean score on the positive dimension weighted by dominance.

- Closeness in the diagram plane (i.e. similarity in positive and task-oriented behaviors) (Keyton & Springston, 1990; Orasanu et al., 2008)

Such a group has higher group-member satisfaction (Fine, 1986), lower scores on anger and aggression (Orasanu et al., 2008), and higher team performance (Jaffe & Nebezahl, 1990; Parke et al., 2000).¹⁰

Closeness in the diagram plane is related to the finding in the personality literature that *variability* on agreeableness and conscientiousness is negatively related to team performance, meaning that the more similar the team members' scores are on these two factors within each team, the better the performance (see section 5.8.4.1.1.2). However, an advantage to the GDM is that it taps team members' perceptions of other team members' *behaviors* in a specific team.

A Group Diagram can be generated with currently available software that enables crewmembers to rate each other on a 26-item behavioral checklist (Parke, 1985). This checklist has a high inter-rater and item-to-scale reliability (Parke, 1985; Rywick, 1987). Moreover, Group Diagram variables based on team-member behavior ratings have been shown to be reliable over time (Orasanu et al., 2008).

An expert system to give advice can be based on patterns of team interaction produced by crewmember ratings. Ultimately, a Group Diagram can be generated automatically from team interaction. Recent advances in acoustic analysis, audio mining of speech content, and video mining integrated by an Adaptive Fuzzy Inference System can feed data into the 26 behavioral spaces defined by the adjective list. This automatically generated Group Diagram can tie into the expert system and give advice on current team dynamics to the crew and to ground support.

5.8.4.3.3 Linguistic Indicators of Team Cohesion

Recent team communication research has adopted the conceptual tools of socio-linguists and clinical psychologists and identified several features of team communication that indicate a team's social climate or cohesion.

- *Communication flow* among team members (i.e., who is talking, how much, and to whom) was found to be a sensitive measure of interpersonal team processes such as dominance and inclusiveness. Research by Fischer and her colleagues (Fischer, McDonnell, Ho, & Orasanu, 2008; Fischer, McDonnell, & Orasanu, 2007) showed that interactions in cohesive teams were more balanced (i.e., no individual dominated the discourse) and inclusive (i.e., there were no outliers, and interactions involved more team members) than interactions in teams in which team conflict had been induced.
- The extent to which team members are *responsive to one another, take up and extend each other's contributions, and build consensus* are other features reflecting social climate (Bales, 1976; Rogers & Farace, 1975). High levels of team members' responsiveness, collaboration, and agreement were related to team cohesion and superior team performance (Fischer et al., 2007; Orasanu, Fischer, Tada, & Kraft, 2004).
- Social climate is reflected in team members' *affective* communications, such as expressions of praise, sympathy, anger, and disdain. Cohesive teams were found to express more positive affect than competitive teams during missions on the last day of a 3-day experiment, but not during missions on the first day (Fischer et al., 2008).

¹⁰ A different approach involves using these three dimensions to classify values, not behaviors (Koenigs & Cowen, 1988).

- More subtle linguistic devices indicating team cohesiveness include using a “*common*” *lexicon* that is unique to members of the team or group (Conquergood, 1994; Heath, 1983) and use of *first person plural* (“we”) over first person singular (“I”) pronouns (Sexton & Helmreich, 2000).

5.8.4.3.4 Evaluating Organizational Factors

Surveys have been designed for operations personnel that identify cost and schedule pressure, inadequate documentation, and other organizational factors responsible for previous aerospace accidents (Parke, Orasanu, & Tada, 2004). These surveys have been successful in identifying sources of inefficiencies or vulnerabilities within space organizations and for framing potential solutions to those problems (Parke, Orasanu, Castle, & Hanley, 2005; Parke & Dismukes, 2008). The authors recommend that such surveys be administered periodically to both astronauts and operations personnel to identify organizational vulnerabilities before these vulnerabilities contribute to errors or result in an accident.

5.8.4.4 Technologies to Support Team Coordination and Collaboration

Distributed work is prone to losses in coordination and cohesiveness (Kiesler & Cummings, 2002). To ensure optimal team collaboration in exploration missions, it will be essential to design systems that provide an accurate, comprehensive, real-time picture of the current situation, and to implement tools that enable team members to communicate and collaborate effectively.

Tools and procedures should be designed to support distributed team coordination and collaboration processes as described in section 5.8.2, both within flight crews and between flight crews and ground personnel.

In the space flight environment, team coordination and communication occur in three contexts:

- Locally distributed coordination within space crews (e.g., semiautonomous subteams interacting with an onboard crewmember, such as on ISS missions where a subteam conducts an EVA while another crewmember remains on board the station)
- Distributed coordination and communication with no or minimal time lag (synchronous) between space crew and ground operations
- Distributed coordination and communication with time lag (asynchronous) between space crew and ground operations

Support tools will need to accommodate the specific problems posed by these different contexts.

5.8.4.4.1 Tools to Support Team Situation Awareness

As described in section 5.8.2.1.1, team situation awareness is essential for collaboration in coping with challenging and unexpected problems. When crewmembers have shared task and team models, they are more likely to notice opportunities for collaboration, will need to talk less to coordinate their efforts, and will be able to anticipate the actions and needs of others (Gutwin & Greenberg, 2004), resulting in better team performance (Mathieu et al., 2000).

Establishing and maintaining team awareness occurs naturally in face-to-face teams, but is much more complicated in distributed teams where critical cues, including nonverbal communication, are lacking (Gutwin & Greenberg, 2004). Also, distributed team members “can face difficulties in forming conventions when they hold different mental models of their work processes” (Mark, 2002).

Research has indicated that overall effectiveness (i.e., quality) of idea-generation tasks and other intellectual tasks is similar for face-to-face teams and distributed teams using computer-mediated communication. However, when it comes to complex tasks, e.g., judgment tasks that require more collaboration among members, face-to-face teams show superior performance (Straus & McGrath, 1994).

5.8.4.4.2 Audio Communication

To ensure effective distributed team coordination and collaboration, it is essential that efficient and reliable communication systems between crew and ground be provided and that open communication be maintained. A wireless system is needed to support both intra-vehicle (crew-to-crew) communication and crew-to-ground communication. Currently, the ability to hear voice communication with the ground is sometimes degraded, costing the crew extra time to clarify issues and repeat messages. Also, no wireless communication system is available for the crew to communicate across the ISS modules, which have high ambient noise levels. The current system consists of audio terminal units located at the ends of the modules, to which the crew must move to talk to ground personnel or to each other between modules. An estimated six hours per week of crew time is spent moving to audio terminal units to facilitate communication. During drills and alarms, the crew has reported difficulty contacting the ground without first acknowledging the alarms, which can take up to 20 to 30 minutes (Baggerman, Rando, & Duvall, 2004).

5.8.4.4.3 Onboard Video Capability

Adoption of videoconferencing capabilities is important for maximizing efficiency and productivity in spatially distributed teams. Videoconferencing is a promising tool to support team situation awareness and task models, especially during tasks involving high levels of team coordination and collaboration. Sharing a visual environment greatly improves communication and facilitates understanding (Fussell, Kraut, & Siegel, 2000; Karsenty, 1999; Kraut, Fussell, Brennan, & Siegel, 2002; Whittaker & Geelhoed, 1993). Teams with videoconferencing capabilities are significantly more efficient in completing problem-solving tasks than teams that rely on online chat communications (Hambley, O'Neill, & Kline, 2007).

For tasks that require minimal coordination and do not have tight time restrictions, nonvisual computer-mediated communication between space crews and ground operations may be adequate. However, when time is limited, videoconferencing capabilities can greatly improve efficiency. This is especially relevant for tasks where enabling ground operations to see what is happening on board could save substantial time compared to explaining verbally what the crew is seeing.

An additional benefit of videoconferencing capabilities is that members of teams with video interaction rate their team higher on cohesion and report higher levels of satisfaction than those using chat room technologies (Hambley et al., 2007; Wakertin, Sayeed, & Hightower, 1997).

5.8.4.4.4 Tools for Asynchronous Collaboration and Coordination

Incorporating procedures and tools that promote successful asynchronous collaboration enables distributed team members to continue working during communication lags and outages.

Communication media that introduce even small delays make establishing common ground (i.e., mutual awareness and knowledge) substantially more difficult to accomplish (Krauss & Bricker, 1966; Kraut et al., 2002). Asynchronous text-based communication, such as e-mail, requires more explicit message formulation than spoken communication due to the lack of immediate feedback that the message has been understood. Whereas mutual awareness and understanding can develop in a matter of minutes

during synchronous conversations, it can take hours or days to develop with asynchronous communications (Kraut et al., 2002). This type of delay can have a substantial impact on the efficiency and success of distributed team collaborations, especially those that are very complex or time-intensive.

Audio and video communication tools can be useful during asynchronous operations because they can provide auditory and visual details about problems that would be much harder to convey through text-based communications. This can reduce the number of information transfer cycles required to resolve problems by providing enough quality information in the first transmission that further clarification is reduced or unnecessary. It also provides the added benefit of allowing the monitoring of crewmembers for signs of stress or illness that can be detected via voice and visual observation.

Although delays in communication will be unavoidable as missions travel farther from Earth, some of the disruption in performance and efficiency imposed by the delays can be mitigated by incorporating procedures and mechanisms that enable space crews to proceed with tasks, make decisions, and solve problems autonomously during lags in communication. Tools that are useful in asynchronous operations include domain-specific tools, whiteboards, and groupware (see section 5.8.4.4.6 for details).

5.8.4.4.5 Tools to Support Autonomous Operations

Autonomous flight crews will need ready onboard access to a full database of appropriate information and tools to facilitate decision-making when ground support is not available. This implies (a) a data architecture that is easily searchable and (b) access to relevant contractor documents. With space crews flying longer distances from Earth and gaps in communication with ground also becoming longer, there will be a need for space crews to have access to simplified, readily understandable procedures and information that will enable them to complete tasks and make decisions without outside assistance. Information must also be available to support autonomous medical care and crew health (see section 10.13). In addition to specific tools, training techniques such as cross-training crewmembers to establish multiple proficiencies, as well as CRM, TACT, TDT, and IST training to teach crewmembers to effectively support and rely on each other, can enable crews to function and adapt more effectively during autonomous operations. (See section 5.8.4.2 for details of training techniques.)

5.8.4.4.6 Selection of Team Collaboration Tools

Choosing tools to promote good team situation awareness, efficient teamwork, and successful outcomes among distributed crews depends on several factors (Bolstad & Endsley, 2005):

- *Specific collaboration characteristics*: Synchronous vs. asynchronous, scheduled (predicted times) vs. unscheduled, co-located vs. distributed, and one-way vs. interactive communication
- *Specific tool characteristics*: Recorded trail of contributions, identification of contributors, and structured vs. flexible communications
- *Types of information*: Oral (spoken), written, spatial-graphical, emotional, photographic, video
- *Types of collaborative processes*: Planning, scheduling, brainstorming, information tracking, data gathering and distribution

The following collaborative tools have been identified as flexible enough to accommodate synchronous or asynchronous interaction and co-located or distributed teams, making them well suited to support collaboration between space crews and ground personnel in future space missions (Bolstad & Endsley, 2003):

- *Domain-specific tools* enable distributed participants to transmit information required for specific tasks or individuals from one person's computer display to another's.

- *Whiteboards* enable distributed participants to share and modify information in a dedicated space on a computer display.
- *Groupware* enables distributed participants to work on a common task in a shared, interactive computer-based environment and is designed to focus and enhance communications, deliberations, and decision-making of groups.

5.8.4.4.7 Emerging Distributed Team Support Tools

Many new options in groupware are being developed to help distributed teams share information and gain the awareness needed for optimal performance. The five most critical elements for supporting group awareness during synchronous distributed collaborative tasks including brainstorming, technical document preparation, and creative writing are these (Tran, Raikundalia, & Yang, 2006):

- Being able to comment on what other users have done
- Knowing what actions other users are currently taking
- Providing a communication tool when audio is not available
- Knowing other users' working areas in the document or task
- Knowing other users' tasks

These elements have specific relevance for space flight, where the space crew and ground control need to be able to effectively revise procedures, brainstorm solutions, and perform other work collaboratively, sometimes in time-critical high-risk situations. Therefore, these elements should be used as criteria for choosing team collaboration tools.

Four new awareness mechanisms are presently being developed (Tran et al., 2006) and could prove useful for space operations:

- **Dynamic Task List:** An active list of all collaborators' tasks, identified by names and corresponding text colors, that is immediately updated as tasks are added, removed, and modified.
- **Modifications Director:** Notifies users immediately when other users have modified their work by flashing a corresponding icon on the user's screen.
- **Advanced Chat:** Enables users to attach document objects such as text and diagrams to a chat conversation message, especially useful when audio communication is not possible.
- **Split Window View:** Provides the views of other authors' working areas and viewing areas simultaneously.

When the appropriate teamwork support systems are designed into new space vehicles, future missions can support more effective collaboration and better performance than previously possible, despite the stressors of long-duration missions.

- Alba, J. W., & Hutchinson, J. W. (1987). Dimensions of consumer expertise. *Journal of Consumer Research*, 13, 411–454.
- Aldrich, T., Szabo, S. & Bierbaum, C. (1989). The development and application of models to predict operator workload during system design. In G. McMillan, D. Beevis, E. Salas, M.H. Strub, R. Sutton, & L. Van Breda (Eds.), *Applications of Human Performance Models to System Design* (pp. 259-273). New York, NY: Plenum Press.
- Alfrey, C.P., Udden, M.M., Leach-Huntoon, C., Driscoll, T., Pickett, M.H.. (1996). Control of red blood cell mass in spaceflight. *J. Appl. Physiol.* 81: 98–104.
- Allendorfer, K., & Friedman-Berg, F. (2007). *Human Factors Analysis of safety alerts in air traffic control*. FAA Technical Report DOT/FAA/TC 07/22.
- Alper, S., Tjosvold, D., & Law, K. S. (2000). Conflict management, efficacy, and performance in organizational teams. *Personnel Psychology*, 53, 623–642.
- Altmann, E. M., & John, B. E. (1999). Episodic indexing: A model of memory for attention events. *Cognitive Science: A Multidisciplinary Journal*, 23(2), 117–156.
- Amason, A. C. (1996). Distinguishing the effects of functional and dysfunctional conflict on strategic decision making: resolving a paradox for top management groups. *Academy of Management Journal*, 39, 123–148.
- American College of Occupational and Environmental Medicine (2003), ACOEM evidence-based statement: Noise-induced hearing loss. *Journal of Occupational Medicine*, 45(6), 579–581.
- American College of Sports Medicine Position Stand. Quantity and Quality of Exercise for Developing and Maintaining Cardiorespiratory, Musculoskeletal, and Neuromotor Fitness In Apparently Healthy Adults: Guidance for Prescribing Exercise. *Med Sci Sports Exerc* 43(7): 1334-59, 2011
- American Standards Association (1960). *Acoustical Terminology SI*, 1-1960. New York, NY: American Standards Association.
- Anderson, J. R. (1993). *Rules of the mind*. Hillsdale, NJ: Lawrence Erlbaum Associates.
- Anderson, J. R., & Lebiere, C. (1998). *The atomic components of thought*. Hillsdale, NJ: Lawrence Erlbaum Associates.
- Ando, S., Kida, N., & Oda, S. (2002). Practice effects on reaction time for peripheral and central visual fields. *Perceptual and Motor Skills*, 95(1), 747–751.
- Andre, A. D., Heers, S. T., & Cashion, P. A. (1995). Effects of workload preview on task scheduling during simulated instrument flight. *International Journal of Aviation Psychology*, 5(1), 5–23.
- André-Deshays, C., Israël, I., Charade, O., et al. (1993). Gaze control in og. 1. Saccades, pursuit, eye-head coordination. *J Vestib Res*, 3, 331–344
- Angelaki, D., McHenry, M., Dickman, J. D., Newlands, S., & Hess, B. (1999). Computation of inertial motion: neural strategies to resolve ambiguous otolith information. *J Neurosci*, 19, 316–327.
- Antonio, A. L., Chang, M. J., Hakuta, K., Kenny, D., Levin, S., & Milem, J. (2004). Effects of racial diversity on complex thinking in college students. *Psychological Science*, 15, 507–514.

- Arrott A. P., Young, L. R. (1986). M.I.T./Canadian vestibular experiments on the Spacelab-1 mission: 6. Vestibular reactions to lateral acceleration following ten days of weightlessness. *Exp Brain Res*, 64, 347–357.
- Arthur, W., Bennett, W., Edens, P. S., & Bell, S. T. (2003). Effectiveness of training in organizations: A meta-analysis of design and evaluation features. *J Appl Psychol*, 88(2), 234–245.
- Avdeev, S., Bidoli, V., Casolino, M., De Grandis, E., Furano, G., Morselli, A., et al. (2002). Eye light flashes on the *Mir* space station. *Acta Astronaut*, 50(8), 511–525.
- Avery, L. W., & Bowser, S. E. (Eds.). (1992). *Department of Defense human-computer interface style guide* (Version 2.0, DOE HFDG ATCCS V2.0 also known as DOD HCISG V2). Washington, DC: Defense Information Systems Agency.
- Avolio, B. J. (1999). Full leadership development: *Building the vital forces in organizations*. Thousand Oaks, CA: Sage.
- Backs, R.W., Walrath, L. C. (1992). Eye Movement and papillary response indices of mental workload during visual search of symbolic displays. *Applied Ergonomics*, 23, 243-254.
- Baddeley, A. D. (1972). Selective attention and performance in dangerous environments. *British Journal of Psychology*, (6), 537–546.
- Baddeley, A.D., & Hitch, G.J. (1974). Working Memory. In G.A. Bower (Ed.), *The psychology of learning and motivation: Advances in research and theory* (Vol. 8, pp. 47–89). New York, NY: Academic Press.
- Baggerman, S. D., Rando, C. M., & Duvall, L. E. (2004). Habitability and human factors: Lessons learned in long duration space flight. *Proceedings of the American Institute of Aeronautics and Astronautics Space, Conference and Exhibit*, San Diego, CA.
- Bales, R. F. (1950). *Interaction process analysis: A method for studying small groups*. Cambridge, MA: Addison-Wesley.
- Bales, R. F. (1953). Equilibrium problem in small groups. In T. Parsons, R. F. Bales & E. A. Shils (Eds.), *Working Papers in the Theory of Action*, (pp. 111-161). New York, NY: Free Press.
- Bales, R. F. (1976). *Interaction process analysis: A method for the study of small groups* (Revised). Chicago, IL: The University of Chicago Press.
- Bales, R. F., & Cohen, S. P. (1979). SYMLOG: *A system for the multiple level observation of groups*. New York, NY: The Free Press.
- Ball K., & Sekuler R. (1987). Direction-specific improvement in motion discrimination. *Vision Res*, 27(6), 953–65.
- Bandaret, L. E., & Lieberman, H. R. (1989). Treatment with tyrosine, a neurotransmitter precursor, reduces environmental stress in humans. *Brain Research Bulletin*, 22, 759–762.
- Baranski, J. V., Thompson, M. M., Lichacz, F. M., McCann, C., Gil, V., Past, L., et al. (2007). Effects of sleep loss on team decision making: Motivational loss or motivational gain? *Human Factors*, 49(4), 646–660.
- Barlow, H. B. (1958). Temporal and spatial summation in human vision at different background intensities. *J Physiol*, 141, 337–350
- Barten, P. G. J. (1992). Physical model for the contrast sensitivity of the human eye. *SPIE Proceedings*, 1666, 57–72.

- Bartlett, F. C. (1932). *Remembering: A study in experimental and social psychology*. New York, NY: Cambridge University Press.
- Bashore, T. R., & Ridderinkhof, K. R. (2002). Older age, traumatic brain injury, and cognitive slowing: Some convergent and divergent findings. *Psychological Bulletin*, 128, 151–198.
- Bass, B. M., Avolio, B. J., Jung, D. I., & Berson, Y. (2003). Predicting unit performance by assessing transformational and transactional leadership. *J Appl Psychol*, 88(2), 207–218.
- Batson, C. D., Brady, R. A., Peters, B. T., Ploutz-Snyder, R. J., Mulavara, A. P., Cohen, H. S., Bloomberg, J. J. (2011). Gait training improves performance in healthy adults exposed to novel sensory discordant conditions. *Exp Brain Res*. 209: 515-524.
- Beal, D. J., Cohen, R. R., Burke, M. J., & McLendon, C. L. (2003). Cohesion and performance in groups: A meta-analytic clarification of construct relations. *J Appl Psychol*, 88(6), 989–1004.
- Bearman, C. R., Paletz, S. B. F., & Orasanu, J. (2007). *An exploration of situational pressures on decision making: Goal seduction and situation aversion*. Poster presented at the 8th International Conference of Naturalistic Decision Making, Pacific Grove, CA.
- Bearman, C., Paletz, S. B. F., & Orasanu, J. (under review). The Breakdown of Coordinated Decision Making in Safety-Critical Domains (incomplete reference).
- Bearman, C. R., Paletz, S. B. F., Orasanu, J., Farlow, S., & Bernhard, R. (2005). *Alternative perspectives on aviation weather: Pilot/Air Traffic Controller conflicts concerning weather*. Paper presented at the 13th International Symposium on Aviation Psychology, Oklahoma City, OK.
- Beatty, J., & Kahneman, D. (1966). Pupillary changes in two memory tasks. *Science*, Vol 154, no. 3756, pp 1583-1585.
- Beatty, J (1982). Task-evoked pupillary responses, processing load, and the structure of processing resources. *Psychological Bulletin*, 91, 276–292.
- Begault, D. R. (1994). *3-D sound for virtual reality and multimedia*. Boston, MA: AP Professional.
- Begault, D. R. (2004). *Binaural hearing and intelligibility in auditory displays*. Invited panel presentation, 75th Scientific Meeting of the Aerospace Medical Association, Anchorage, AK.
- Bell, S. T. (2007). Deep-level composition variables as predictors of team performance: A meta-analysis. *J Appl Psychol*, 92(3), 595–615.
- Bellenkes, A. H., Wickens, C. D., & Kramer, A.F. (1997). Visual scanning and pilot expertise: The role of attentional flexibility and mental model development. *Aviat Space Environ Med*, 68(7), 569–579.
- Benson A. J., Spencer M. B., Stott J. R. (1986). Thresholds for the detection of the direction of whole-body, linear movement in the horizontal plane. *Aviat Space Environ Med* 57: 1088-1096.
- Benson, A. J. (1990). Sensory function and limitations of the vestibular system, In R. Warren & A.H. Wertheim (Eds.). *Perception and Control of Self-Motion* (pp.145-170). Mahwah, NJ: Lawrence Erlbaum Associates.
- Berman, B. (1995). Flightcrew errors and the contexts in which they occurred: 37 major U.S. air carrier accidents, *Proceedings of the 8th International Symposium on Aviation Psychology* (pp. 1291-1294). Columbus, OH: Ohio State University.
- Berglund, B; Lindvall T, and Schwela D. (1999). *Guidelines for Community Noise*, World Health Organization, Geneva.

- Billings, C. E. (1997). *Aviation automation: The search for a human-centered approach*. Hillsdale, NJ: Lawrence Erlbaum Associates.
- Bishop, P. A., Lee, S. M., Conza, N. E., Clapp, L. L., Moore, A. D., Williams, W. J., Guillems, M. E., Greenisen, M. C.. (1999). Carbon dioxide accumulation, walking performance, and metabolic cost in the NASA launch and entry suit. *Aviat Space Environ Med* 70: 656–665.
- Bishop, S. (2004). Evaluating teams in extreme environments: From issues to answers. *Aviat Space Environ Med*, 76, C14–C21.
- Bittner, A. C., Byers, J. C., Hill, S. G., Zaklad, A. L., & Christ, R. E. (1989). Generic workload ratings of a mobile air defense system (LOS-F-H). In *Proceedings of the Human Factors Society 33rd Annual Meeting*. Santa Monica, CA: Human Factors & Ergonomics Society.
- Black, F. O., et al. (1999) Disruption of postural readaptation by inertial stimuli following space flight. *J Vestib Res* 9(5): 369-78.
- Black, F. O., et al. (1995) Vestibular plasticity following orbital spaceflight: recovery from postflight postural instability. *Acta Otolaryngol Suppl.* 520 Pt 2: 450-4.
- Blackwell, H. R. (1946). Contrast thresholds of the human eye. *J Opt Soc Am*, 36 624–643.
- Blandford, A., & Wong, B. L. W. (2004). Situation awareness in emergency medical dispatch. *International Journal of Human-Computer Studies*, 61, 421-452.
- Blauert, J. (1983). *Spatial hearing: The psychophysics of human sound localization*. Cambridge, MA: The MIT Press.
- Bloomberg, J. J., Layne, C. S., McDonald P., Peters B. T., Huebner W. P., Reschke, M. F., Berthoz, A. Glasauer S., Newman, D., & Jackson D. K. (1999). Section 5.5. Effects of space flight on locomotor control. In C. F. Sawin, G. R. Taylor, & W. L. Smith (Eds.) *Extended Duration Orbiter Medical Project 1989–1995* (NASA SP-1999-534). Washington, DC: National Aeronautics and Space Administration.
- Bloomberg, J. J. & Mulavara A.P. (2003). Changes in walking strategies after spaceflight. *IEEE Eng Med Bio Mag*, 22, 58–62.
- Bloomberg, J. J., Peters, B. T., Smith, S. L., Huebner, W. P., Reschke, M. F. (1997). Locomotor head-trunk coordination strategies following space flight. *J Vestib Res.* 7: 161-177.
- Boag, C., Neal, A., Loft, S., Halford, G. (2006). An analysis of relational complexity in an air traffic control conflict detection task. *Ergonomics*, 49, 1508–1526.
- Boff, D. R., & Lincoln, J. E. (1988). Engineering data compendium: Human perception and performance. AAMRL, Wright-Patterson AFB, OH.
- Boff, K., Kaufman, L., & Thomas, J. (1986). *Handbook of Perception and Human Performance* (eds.). Wiley, New York, NY.
- Bolstad, C. A., & Endsley, M. R. (2005). Choosing team collaboration tools: Lessons learned from disaster recovery efforts. *Ergonomics in Design*, 13(4), 7–13.
- Booher, H., & Minninger, J. (2003). Human systems integration in Army systems acquisition. In H. R. Booher (Ed.), *Handbook of human systems integration* (pp. 663-698). Hoboken, NJ: Wiley.
- Bortolussi, M. R., Hart, S. G., & Shively, R. J. (1989). Measuring moment-to-moment pilot workload using synchronous presentations of secondary tasks in a motion-base trainer. *Aviat Space Environ Med*, 60(2), 124–129.

- Bortolussi, M. R., Kanrotitz, B. H. & Hart, S. G. (1986). Measuring pilot workload in a motion base simulator. A comparison of four techniques. *Applied Ergonomics*, 17, 278–283.
- Bourne, L. E., Jr. & Yaroush, R. A. (2003). *Stress and Cognition: A cognitive Psychological Perspective. (Final Report for NAG2-1561)*. Washington, DC: National Aeronautics & Space Administration.
- Bowers, C. A., Jentsch, F., Salas, E., & Braun, C. C. (1998). Analyzing communication sequences for team training needs. *Human Factors*, 40, 672–679.
- Boynton, R. M. (1989). Eleven colors that are almost never confused. In B. E. Rogowitz (Ed.), *Proceedings of the SPIE*, 1077, Human Vision, Visual Processing and Digital Display, 322-332.
- Bradley, J., White, B. J., & Mennecke, B. E. (2003). Teams and tasks: A temporal framework for the effects of interpersonal interventions on team performance. *Small Group Research*, 34(3), 353–387.
- Brainard, D. H. (2003). Color appearance and color difference specification. In S. K. Shevell (Ed.), *The science of color* (pp. 191-213). Amsterdam: Elsevier.
- Brebner, J. M. T., & Welford, A. T. (Eds.). (1980). *Reaction times*. New York: Academic Press.
- Bregman, A. S. (1990). *Auditory scene analysis: The perceptual organization of sound*. Cambridge, MA: The MIT Press.
- Brehmer, B. (1994). Some notes on psychological research related to risk. In N. E. Sahlin & B. Brehmer (Eds.), *Future risks and risk management* (pp. 79–91). Amsterdam, The Netherlands: Kluwer Academic Publishers.
- Brehmer, B., & Allard, R. (1991). Dynamic decision making: The effects of task complexity and feedback delay. In J. Rasmussen, B. Brehmer & J. Leplat (Eds.), *Distributed decision making: Cognitive models for cooperative work* (pp. 319–334). New York, NY: John Wiley and Sons.
- Bringard, A., Pogliaghi, S., Adami, A., De Roia, G., Lador, F., Lucini, D., Pizzinelli, P., Capelli, C., Ferretti, G. (2010). Cardiovascular determinants of maximal oxygen consumption in upright and supine posture at the end of prolonged bed rest in humans. *Respir Physiol Neurobiol* 172: 53–62.
- Broadbent, D. E. (1971). *Decision and stress*. London, UK: Academic Press.
- Broadbent, D. E. (1979). Human performance effects. Academy and noise. In C. M. Harris (Ed.), *Handbook of Management Noise Control* (2nd ed., pp. 17.1–17.20). New York, NY: McGraw-Hill.
- Brooks K. R. & Stone L. S. (2004). Stereomotion speed perception: contributions from both changing disparity and interocular velocity difference over a range of relative disparities. *Journal of Vision*, 4(12):6, 1061-79.
- Brooks K. R. & Stone L. S. (2006). Stereomotion suppression and the perception of speed: Accuracy and precision as a function of 3D trajectory. *Journal of Vision*, 6, 1214-1223.
- Brown, J. W., Kosmo, J. & Campbell, P. D. (1991). *Internal atmospheric pressure and composition for planet surface habitats and extravehicular mobility units* (JSC-25003, LESC-29278), Houston, TX: National Aeronautics and Space Administration.
- Buckey J. C. & Homick, J. L. (2003). *The Neurolab Spacelab Mission: Neuroscience research in space* (SP 2002-535). Washington, DC: National Aeronautics and Space Administration.
- Buckey, J. C. Jr., Lane, L. D., Levine, B. D., Watenpugh, D. E., Wright, S. J., Moore, W. E., Gaffney, F. A., Blomqvist, C. G. (1996). Orthostatic intolerance after spaceflight. *J. Appl. Physiol.* 81: 7–18.

- Bunderson, J. S. & Sutcliffe, K. M. (2002). Comparing alternative conceptualizations of functional diversity in management teams: Process and performance effects. *Academy of Management Journal*, 45: 875-893.
- Bungo, M. W., Charles, J. B., Johnson, P. C. (1985). Cardiovascular deconditioning during space flight and the use of saline as a countermeasure to orthostatic intolerance. *Aviat Space Environ Med* 56: 985-990.
- Burbeck, C. & Kelly, D. H. (1980). Spatiotemporal characteristics of visual mechanisms: excitatory-inhibitory model. *J Opt Soc Am*, 70(9), 1121-1126.
- Burke, C. S., Stagl, K. C., Salas, E., Pierce, L., & Kendall, D. (2006). Understanding team adaptation: A conceptual analysis and model. *J Appl Psychol*, 91(6), 1189-1207.
- Burrough, B. (1998). *Dragonfly: NASA and the crisis aboard Mir*. New York, NY: Harper Collins.
- Byers, J. C., Bittner, A., Hill, S. G., Zaklad, A. L., & Christ, R. E. (1998a). Workload assessment of a remotely piloted vehicle (RPV) system. In *Proceedings of the Human Factors Society 32nd Annual Meeting* (pp. 1145-1149). Santa Monica, CA: Human Factors Society.
- Byrne, E. A., Chun, K. M., Parasuraman, R. (1995). Differential Sensitivity of Heart Rate and Training Heart Rate Variability as Indices of Mental Workload in a Multi-Task Environment. In R. S. Jensen and L. A. Rakovan (Eds.), *Proceedings of the Eighth International Symposium on Aviation Psychology* (Vol 2, p. 881-885). Columbus, OH: Ohio State University.
- Canfield, A. A., Comrey, A. L. & Wilson, R. C. (1949). A study of reaction time to light and sound as related to positive radial acceleration. *Journal of Aviation Medicine*, 20, 350.
- Cannon-Bowers, J. A., Salas, E., Blickensderfer, E., & Bowers, C. A. (1998). The impact of cross-training and workload on team functioning: A replication and extension of initial findings. *Human Factors*, 40, 92-101.
- Cannon-Bowers, J. A., & Salas, E. (1998b). *Making decisions under stress: Implications for individual and team training*. Washington DC: APA Press.
- Cannon-Bowers, J. A., Salas, E., Blickensderfer, E., Bowers, C. A. (1998). The impact of cross-training and workload on team functioning: A replication and extension of initial findings. *Human Factors*, 40 (1), 92-101.
- Cannon-Bowers, J. A., Salas, E., & Converse, S. A. (1993). Shared mental models in expert team decision making. In J. J. Castellan (Ed.), *Individual and group decision making: Current issues* (pp. 221-246). Hillsdale, NJ: LEA.
- Cannon-Bowers, J. A., Salas, E., Blickensderfer, E., & Bowers, C. A. (1998). The impact of cross-training and workload on team functioning: A replication and extension of initial findings. *Human Factors*, 40, 92-101.
- Card, S., Moran, T., & Newell, A. (1983). *The Psychology of Human-Computer Interaction*, Lawrence Erlbaum Associates, Hillsdale, NJ. [Book that introduces the GOMS model]
- Carlson, C. R. (1982). Sine-wave threshold contrast-sensitivity function; dependence on display size. *RCA Review*, 43, 675-683.
- Carron, A. V., Colman, M. M., Wheeler, J., & Stevens, D. (2002). Cohesion and performance in sport: A meta-analysis. *Journal of Sport and Exercise Psychology*, 24, 168-188.

- Carron, A. V., Widmeyer, W. N., & Brawley, W. N. (1985). The development of an instrument to measure cohesion in sport teams: The group environment questionnaire. *Journal of Sport Psychology*, 7, 244–266.
- Carter, J. A., Buckey, J. C., Holland, A. W., Hegel, M. T., & Greenhalgh, L. (2003). Best practices for managing conflict and depression on long-duration space flights: The astronauts' perspectives [Abstract]. Paper presented at the 14th IAA Humans in Space Symposium, Banff, Canada.
- Cartreine, J. A., Buckey, J. C., Hegel, M. T., & Locke, S. E. (2009). Self-guided depression treatment on long-duration space flights: a continuation study. Poster presented at the annual Investigators' Workshop for the NASA Human Research Program, League City, TX, Feb. 3, 2009.
- Casner, S. M. (2005). Transfer of learning between a small technically advanced aircraft and a modern commercial jet. *International Journal of Applied Aviation Studies* 5 (2) 307-319.
- Casner, S. M. (2009). Perceived vs. Measured Effects of Advanced Cockpit Systems on Pilot Workload and Error: Are Pilots' Beliefs Misaligned With Reality? *Applied Ergonomics*, 40(3) 448-456.
- Casner, S. M. & Gore, B. F. (2010). Measuring and evaluating workload: A primer, NASA/TM 2010-1850. National Aeronautics and Space Administration, Washington, D.C.
- Casolino, M., Bidoli, V., Morselli, A., Narici, L., De Pascale, M. P., Picozza, P., et al. (2003). Space travel: Dual origins of light flashes seen in space. *Nature*, 422(6933), 680-680, <http://dx.doi.org/10.1038/422680a>.
- Chaikin, A. (1985). The loneliness of the long-distance astronaut. *Discover*, 20–31.
- Chambers, R. M. & Hitchcock, L. (1963). Effects of acceleration on pilot performance. Aviation Medical Acceleration Laboratory, USN Air Development Center, Report NADC-MA-6219.
- Chambers, R. M. (1961). Control performance under acceleration with side-arm attitude controllers. Aviation Medical Acceleration Laboratory, USN Air Development Center, Report NADC-MA-6110.
- Chambers, R. M., Hitchcock L., Jr., (1962). Effects of High G conditions on pilot performance, *Proceedings of the National Meeting of Manned Space Flight*, New York: Institute of Aerospace Sciences, pp 204-227.
- Cherry, E. C. (1953). Some experiments on the recognition of speech, with one and with two ears. *The Journal of the Acoustical Society of America*, 25, 975–979.
- Chi, M. T. H., Glaser, R., & Farr, M. J. (Eds.). (1988). *The Nature of Expertise*. Hillsdale, NJ: Lawrence Erlbaum Associates.
- Chidester, T. Chambers R., Helmreich, L. R., Gregorich, S., & Geis, C. E. (1991). Pilot personality and crew coordination: Implication for training and selection. *International Journal of Aviation Psychology*, 1991; 1:25–44.
- Chou, C., Madhavan, D., & Funk, K. (1996). Studies of cockpit task management errors. *The International Journal of Aviation Psychology*, 1, 23-42.6(4), 307–32.
- Clark, J. (2007). A flight surgeon's perspective on crew behavior and performance. Paper presented at the The Workshop for Space Radiation Collaboration with BHP, CASS.
- Clement, G. (2003). *Fundamentals of Space Medicine*. Amsterdam, The Netherlands: Kluwer.
- Clement, G. & Reschke, M. F. (2008). *Neuroscience in Space*. New York, NY: Springer.
- Coan, J. A., Schaefer, H. S., & Davidson, R. J. (2006). Lending a hand: Social regulation of the neural response to threat. *Psychological Science*, 17(12), 1032–1039.

- Cohen, B. P., & Ledford, G. E., Jr. (1994). The effectiveness of self-managing teams: A field experiment. *Human Relations*, 47, 13–43.
- Cohen, M. M. (1970). Hand-Eye coordination in altered gravitational fields. *Aerospace Medicine*, 41, 647–649.
- Cohen, M. M., & Welch, R. B. (1992). Visual-motor control in altered gravity. In: D. Elliott & L. Proteau (Eds.), *Vision and motor control* (pp. 153–175). Amsterdam, The Netherlands: Elsevier.
- Cohen, M. S., Freeman, J. T., & Wolf, S. G. (1996). Metacognition in time-stressed decision making: Recognizing, critiquing, and correcting. *Human Factors*, 38(2), 206-219
- Cohen, S. G. & Bailey, D. E. (1997). What makes teams work: Group effectiveness research from the shop floor to the executive suite. *Journal of Management*, 23(3), 239-290
- Cohen, S. & Weinstein, N. (1981). Nonauditory effects of noise on behavior and health. *Journal of Social Issues*, 37, 36–70.
- Colford, N. (2002). Displays in space. *Displays*, 23, 75–85.
- Colle, H. A. & Reid, G. B. (2005). Estimating a mental workload Redline in a simulated airto-ground combat mission. *International Journal of Aviation Psychology*, 15, 303-319.
- Collins, C. C., Crosbie, R. J. & Gray, R. F. (1958). Letter report concerning pilot performance and tolerance study of orbital reentry acceleration. Aviation Medical Acceleration Laboratory, USN Air Development Center, Report NADC-LR-64.
- Collins, M. W., Field, M., Lovell, M. R., et al. (2003). Relationship between post-concussion headache and neuropsychological test performance in high school athletes. *Am J Sports Med*, 31, 168–173.
- Combs, A. W. & Taylor, C. (1952). The effect of the perception of mild degrees of threat on performance. *Journal of Abnormal and Social Psychology*, 47, 420–424.
- Commission internationale de l'Eclairage proceedings* (CIE). (1932). Cambridge University Press, Cambridge.
- Committee on Space Biology and Medicine, and National Research Council (1998). *A strategy for resesarch in space biology and medicine in the new century*, Washington, DC: National Research Council, National Academies Press.
- Connor, C. E., Egeth, H. E., & Yantis, S. (2004). Visual attention: Bottom-up vs. top-down. *Current Biology*, 14, 850-852.
- Connors, K. & Staff, M. H. S. (2000). *Conner's continuous performance test-II user's manual*. Toronto, Canada: Multi-Health Systems.
- Connors, M. M., Harrison, A. A., & Akins, F. R. (1985). *Living aloft: Human requirements for extended spaceflight* (NASA SP-483). Washington, DC: National Aeronautics and Space Administration.
- Conquergood, D. (1994). Homeboys and hoods: Gang communication and cultural space. In L. R. Frey (Ed.), *Group communication in context: Studies of natural groups* (pp. 23–55). Hillsdale, NJ: Erlbaum.
- Cooke, N. J., Cooper, G. E., & Harper, R P. (1969). *The use of pilot ratings in the evaluation of aircraft handling qualities* (NASA TN D-5153). Washington, DC: National Aeronautics and Space Administration.
- Corballis, M. C., Zbrodoff, N. J., Shetzer, L. I., & Butler, P. B. (1978). Decisions about identity and orientation of rotated letters and digits. *Memory and Cognition*, 6, 98–107.

- Corker, K. M., & Smith, B. (1993). An architecture and model for engineering simulation analysis: Application to advanced aviation automation. *Proceedings of AIAA Computing in Aerospace 9 Conference*. San Diego, CA.
- Corker, K. M., Gore, B. F., Fleming, K., & Lane, J. (2000). Free flight and the context of control: Experiments and modeling to determine the impact of distributed air-ground air traffic management on safety and procedures. *Proceedings of the 3rd USA-Europe Air Traffic Management R & D Seminar*, Naples, Italy: USA-Europe Air Traffic Management.
- Corker, K. M., Lozito, S., & Pisanich, G. (1995). Flight crew performance in automated air traffic management. In Fuller Johnston, & McDonald (Eds.), *Human Factors in Aviation Operation* (Vol. 3). Hants, UK: Avebury Aviation.
- Corwin, W., Sandry-Garza, D., Biferno, M., & Boucek, G., Logan, J. & Metalis, S. (1989a). Assessment of crew workload measurement methods, techniques and procedures. Vol 1: Process methods and results. Cockpit Integration Directorate, Wright Research and Development Center, Air Force Systems Command, Wright-Patterson Air Force Base. WRDC-TR-89-7006 Volume I.
- Corwin, W., Sandry-Garza, D., Biferno, M., & Boucek, G. (1989b) Assessment of crew workload measurement methods, techniques and procedures. Vol 2: Guidelines for the use of workload assessment techniques in aircraft certification. Cockpit Integration Directorate, Wright Research and Development Center, Air Force Systems Command, Wright-Patterson Air Force Base. WRDC-TR-89-7006 Volume I.
- Corwin, W. H., Biferno, M. H., Metalis, S. A., Johnson, J. E., Sandry-Garza, D. L., Boucek, G. P., & Logan, A. L. (1988). *Assessment of Crew Workload Procedures in Full Fidelity Simulation* (SAE Technical Paper Series No 881383). Warrendale, PA: SAE International.
- Courtine, G., Pozzo, T. (2004). Recovery of the locomotor function after prolonged microgravity exposure. I. Head-trunk movement and locomotor equilibrium during various tasks. *Exp Brain Res*, 158:86–99.
- Cowan, N. (2001). The magical number 4 in short-term memory: A reconsideration of mental storage capacity. *Behavioral and Brain Sciences*, 24, 87–185.
- Cooke, N. J., Kiekel, P. A., and Helm, E. (2001). Measuring team knowledge during skill acquisition of a complex task. *International Journal of Cognitive Ergonomics: Special Section on Knowledge Acquisition*, 5, 297-315.
- Cooper, H. F. S. (1976). *A house in space*. Austin, TX: Rinehart and Winston.
- Costa, P. T., & McCrae, R. R. (1992). *Revised NEO personality inventory and NEO five-factor inventory professional manual*. Florida: Psychological Assessment Resources, Inc.
- Couch, A. (1960). *Psychological determinants of interpersonal behavior*. (Unpublished doctoral dissertation). Harvard University, Cambridge, MA.
- Coyne, R. K., Wilson, F. R., Tang, M., & Shi, K. (1999). Cultural similarities and differences in group work: Pilot study of a U.S.-Chinese task group comparison. *Group Dynamics: Theory, Research and Practice*, 3(1), 40–50.
- Craig, J. M. & Sherif, C. W. (1986). The effectiveness of men and women in problem-solving groups as a function of gender composition. *Sex Roles*, 14, 453–466.
- Creer, B. Y., Smedal, H. A., & Wingrove, R. C. (1960). *Centrifuge study of pilot tolerance to acceleration and the effects of acceleration on pilot performance*. (TN D-337). Washington DC: National Aeronautics and Space Administration.

- CTA Incorporated. (1996). *User-interface guidelines* (DSTL-95-033). Greenbelt, MD: Goddard Space Flight Center.
- Curral, L. A., Forrester, R. H., Dawson, J. F., & West, M. A. (2001). It's what you do and the way that you do it: Team task, team task, and innovation-related group processes. *European Journal of Work and Organizational Psychology*, 10(2), 187–204.
- Cushing, S. (1994). *Fatal words*. Chicago, IL: University of Chicago Press.
- Dai, M., McGarvie, L., Kozlovskaya, I. B., et al. (1994). Effects of space flight on ocular counter-rolling and the spatial orientation of the vestibular system. *Exp Brain Res*, 102, 45–56.
- Daly, S. (1993). The visible differences predictor: an algorithm for the assessment of image fidelity quality. In A. B. Watson (Ed.), *Digital images and human vision*. Cambridge, MA: MIT Press.
- Damos, D. L. (1991). *Multiple-task Performance*. London, UK: Taylor & Francis.
- Daneman, M., & Carpenter, P. A. (1980). Individual differences in working memory and reading. *Journal of Verbal Learning and Verbal Behavior*, 19, 450–456.
- David, H. (2000). Measures of stress/strain on Air Traffic Controllers in simulated air traffic control. In *Proceedings of the IES 2000/HFES 2000 Congress*. Santa Monica, CA: Human Factors & Ergonomics Society.
- Davis, A. (1995). *Hearing in adults*. London, UK: Whurr.
- Davison, J. & Fischer, U. (2003). When language becomes a barrier instead of a bridge: Communication failures between pilots and air traffic controllers. In R. Jensen (Ed.), *Proceedings of the 12th International Symposium on Aviation Psychology*. Dayton, OH.
- Davison, J. & Orasanu, J. (1999). Alternative perspectives on traffic risk. In R. Jensen (Ed.), *Proceedings of the 10th International Symposium on Aviation Psychology*. Columbus, OH: OSU.
- Davranche, K., Audiffren, M., & Denjean, A. (2006). A distributional analysis of the effect of physical exercise on a choice reaction time test. *Journal of Sports Sciences*, 24, 323–329.
- De Dreu, C. K. W. & Weingart, L. R. (2003). Task versus relationship conflict, team performance, and team member satisfaction: A meta-analysis. *J Appl Psychol*, 88(4), 741–749.
- De Dreu, C. K. W. & West, M. A. (2001). Minority dissent and team innovation: The importance of participation in decision making. *J Appl Psychol*, 86, 1191–1201.
- Degani, A. (2004). *Taming Hal: Designing interfaces beyond 2001*. New York: Palgrave.
- De Lange, H. (1958). Research into the dynamic nature of the human fovea-cortex systems with intermittent and modulated light. I. Attenuation characteristics with white and colored light. *J Opt Soc Am A*, 48, 777–784.
- Department of Defense. (1989). *Human engineering guidelines for management information systems (MIL-HDBK-761A)*. Philadelphia, PA: Navy Publishing and Printing Office. Department of Defense. (1997). Department of Defense design criteria standard - Noise limits. [MIL-STD-1474D].
- Department of Defense. (1998). Department of Defense handbook - Handbook for human engineering design guidelines. [MIL-HDBK-759C].
- Department of Defense. (1999). Department of Defense design criteria standard - Human engineering. [MIL-STD-1472F].

- Department of the Navy. (1992). User interface specifications for Navy command and control systems (Version 1.2) (DON UISNCCS). San Diego, CA: NCCOSC, RDT&E Division.
- Deubel, H., & Schneider, W. X. (1996). Saccade target selection and object recognition: Evidence for a common attentional mechanism. *Vision Res*, 36, 1827–1837.
- Devine, D. J. & Phillips, J. L. (2001). Do smarter teams do better? A meta-analysis of cognitive ability and team performance. *Small Group Research*, 507–532.
- Diez, M., Boehm-Davis, D. A., Holt, R. W., et al. (2001). Tracking Pilot Interactions with Flight Management Systems through Eye Movements. In *Proceedings of the 11th International Symposium on Aviation Psychology*, Columbus, OH: Ohio State University.
- Dinges, D. F., Pack, F., Williams, K., Gillen, K. A., Powell, J. W., Ott, G. E., et al. (1997). Cumulative sleepiness, mood disturbance, and psychomotor vigilance performance decrements during a week of sleep restricted to 4-5 hours per night. *Sleep*, 20(4), 267–277.
- Dion, K. L. (2004). Interpersonal and group processes in long-term spaceflight crews: Perspective from social and organizational psychology. *Aviat Space Environ Med*, 75(7), C36–C41.
- Dismukes, K., & Nowinski, J. (2007). Prospective memory, concurrent task management and pilot error. In A. Kramer, D. Wiegmann & A. Kirlik (Eds.), *Attention: from theory to practice* (pp. 6-680). Oxford, UK: Oxford University Press/Oxford Society.
- Dixon, S. R., & Wickens, C. D. (2006). Automation reliability in unmanned aerial vehicle flight control: a reliance-compliance model of automation dependence in high workload. *Human Factors*, 48(3), 474–486.
- Dixon, S., Wickens, C. D., & McCarley, J. M. (2007). On the independence of reliance and compliance: are false alarms worse than misses. *Human Factors*, 49, 564–572.
- Donchin, E., Kramer, A., & Wickens, C. (1986). Applications of event-related brain potentials to problems in engineering psychology. In M. G. H. Coles, E. Donchin, & S. Porges (Eds.), *Psychophysiology: Systems, Processes, and Applications*. New York: Guilford Press.
- Dorfman, T. A., Levine, B. D., Tillery, T., Peshock, R. M., Hastings, J. L., Schneider, S. M., Macias, B. R., Biolo, G., Hargens, A. R.. (2007). Cardiac atrophy in women following bed rest. *Journal of Applied Physiology* 103: 8–16.
- Dorfman, T. A., Rosen, B. D., Perhonen, M. A., Tillery, T., McColl, R., Peshock, R. M., Levine, B. D. (2008). Diastolic suction is impaired by bed rest: MRI tagging studies of diastolic untwisting. *J. Appl. Physiol.* 104: 1037–1044.
- Drazin, R., & Schoonhoven, C. B. (1996). Community, population and organization effects on innovation: A multilevel perspective. *Academy of Management Journal*, 39(5), 1065–1083.
- Dreyfus, H. L. (1979). *What computers can't do: The limits of artificial intelligence*. New York, NY: Harper Collins.
- Driskell, J. E., Salas, E., & Johnston, J. (1999). Does stress lead to a loss of team perspective? *Group Dynamics: Theory, Research and Practice*, 3(4), 291–302.
- Driskell, J. E., Salas, E., & Johnston, J. (2001). Stress management: Individual and team training. In *Improving teamwork in organizations*. E. Salas, C. A. Bowers, & E. Edens (Eds.). Mahwah, NJ: Erlbaum. (pp. 55-72).
- Driskell, J. E., Willis, R. P., & Cooper, C. (1992). Effect of overlearning on retention. *Journal of Applied Psychology*, 77(5), 615–622.

- Duane, T. D., Beckman, E. L., Ziegler, J. E., & Hunter, H. N. (1953). Some observations on human tolerance to exposures of 15 transverse G. ASTIA AD-20 518, *Journal of Avionics Medicine*, 26, 298 Report NADC-MA-5305.
- Duntley, S. Q., Austin, R. W., Taylor, J. H., & Harris, J. L., Sr. (1971). Visual acuity and visibility, experiments S008 and D013. Report Number: EXPT-D013; EXPT-S008 NASA (non Center Specific).
- Eagly, A. H., & Karau, S. J. (1991). Gender and the emergence of leaders: A meta-analysis. *Journal of Personality and Social Psychology*, 60(5), 685–710.
- Earley, P. C., & Gibson, C. B. (1998). Taking stock in our progress on individualism-collectivism: 100 years of solidarity and community. *Journal of Management*, 24, 265–304.
- Earley, P. C., & Mosakowski, E. (2000). Creating hybrid team cultures: An empirical test of transnational team functioning. *Academy of Management Journal*, 43, 26–49.
- Easterbrook, J. A. (1959). The effect of emotion on cue utilization and the organization of behavior. *Psychological Review*, 66(3), 183–201.
- Edland, A., & Svenson, O. (1993). Judgment and decision making under time pressure: Studies and findings. In O. Svenson & J. Maule (Eds.), *Time pressure and stress in human judgment and decision making* (pp. 27–40). New York, NY: Plenum.
- Eid, J., & Johnsen, B. H. (2002). Acute stress reactions after submarine accidents. *Military Medicine*, 167(5), 427–431.
- Elliott, L. R., Schiflett, S. G., Hollenback, J. R., & Mathieu, A. D. (2001). Investigation of situation awareness and performance in realistic command and control scenarios. In M. D. McNeese, E. Salas & Elmuti, D. (2001). Preliminary analysis of the relationship between cultural diversity and technology in corporate America. *Equal Opportunities International*, 20(8), 1–16.
- Emmerich, W. (1968). Personality development and concepts of structure. *Child Development*, 39, 671–690.
- Emmerich, W. (1973). *Structure and development of personal-social behaviors in economically disadvantaged preschool children*. Princeton, NJ: Educational Testing Service.
- Endler, N., & Parker, J. (1990). Coping inventory for stressful situations. In G. O. Einstein & M. A. McDaniel (2004). *Memory fitness: A guide for successful aging*. New Haven, CT: Yale University Press.
- Endler, N., & Parker, J. (1990). *Coping Inventory for Stressful Situations (CISS)*. Simi Valley, CA: Psychological Publications, Inc.
- Endsley, M. (Eds.), *New trends in cooperative activities: Understanding system dynamics in complex environments*. Santa Monica, CA: Human Factors & Ergonomics Society.
- Endsley, M. (2006). Situation awareness. In G. Salvendy (Ed.), *Handbook of human factors and ergonomics* (3rd ed., pp. 528–542). New York: Wiley.
- Endsley, M. R. (1995). Toward a theory of situation awareness in dynamic systems. *Human Factors*, 37(1), 32–64.
- Endsley, M. R. & Jones, W. M. (2001). A model of inter- and intrateam situational awareness: Implications for design, training, and measurement. In M. McNeese, E. Salas & M. Endsley (Eds.), *New trends in cooperative activities: Understanding system dynamics in complex environments* (pp. 46-67). Santa Monica, CA: Human Factors and Ergonomics Society.

- Endsley, M. R., Kaber, D. B., (1997) The combined effect of level of automation and adaptive automation on human performance with complex, dynamic control systems. In the *Proceedings of the 41st annual meeting of the Human Factors and Ergonomics Society* (pp. 205-209). Santa Monica, CA: Human Factors and Ergonomics Society.
- Entin, E. E. & Serfaty, D. (1999). Adaptive team coordination. *Human Factors*, 38, 232–250.
- Entin, E. E., Serfaty, D., & Deckert, J. C. (1994). *Team adaptation and coordination training (TR-648-1)*. Burlington, MA: ALPHATECH.
- Epstein, S., & Fenz, W. D. (1965). Steepness of approach and avoidance gradients in humans a function of experience: Theory and experiment. *J. Experimental Psychology*, 70, 1–13.
- Ericsson, K. A. & Kintsch, W. (1995). Long-term working memory. *Psychological Review*, 102(2), 211-245.
- Farell, B. & Pelli, D. G. (1999). Psychophysical methods, or how to measure a threshold and why. In R. H. S. Carpenter & J. G. Robson (Eds.), *Vision Research: A Practical Guide to Laboratory Methods*. New York, NY: Oxford University Press.
- Federal Aviation Administration (2007) Human Factors Tools (<http://www.hf.faa.gov/Portal/default.aspx>).
- Feldman, J. & Lindell, M. K. (1990). On rationality. In I. Horowitz (Ed.), *Organization and decision theory: Problems and perspectives* (Vol. 18, pp. 83-97). New York, NY: Springer.
- Fenz, W. D. (1975). Strategies for coping with stress. In I. Sarason & C. Spielberger (Eds.), *Stress and anxiety* (pp. 305–336). Washington, DC: Hemisphere.
- Festinger, L. (1950). Informal social communication. *Psychological Review*, 57(5), 271-282.
- Fieandt, K., Huhtala, A., Kullberg, P., & Saarl, K. (1956). Personal tempo and phenomenal time at different age levels. *Psychological Institute Reports*, No. 2, University of Helsinki.
- Fiedler, E. (2004). NASA/JSC behavioral health and performance: Four factors with a focus on cognition in spaceflight. Presented at Cognitive Performance: The Future Force Warrior in a Network Centric Environment. St. Pete Beach, FL.
- Fiedler, F. E. (1967). *A theory of leadership effectiveness*. New York, NY: McGraw-Hill.
- Fine, G. A. (1986). Behavioral change in group space: A reintegration of Lewinian theory in small group research. *Advances in Group Processes*, 3, 23–50.
- Finkelman, J. F., Zeitlin, L. R., Romoff, R. A., Friend, M. A., & Brown, L. S. (1979). Conjoint effect of physical stress and noise stress on information processing performance and cardiac response. *Human Factors*, 21(1), 1–6.
- Finkelman, J. M. & Glass, D. C. (1970). Reappraisal of the relationship between noise and human performance by means of a subsidiary task measure. *J Appl Psychol*, 54(3), 211–213.
- Fischer, U., & Orasanu, J. (1999). Cultural diversity and crew communication. Paper presented at the *Proceedings of the 50th Astronautical Congress in Amsterdam*. American Institute of Aeronautics and Astronautics, Inc
- Fischer, U., McDonnell, L., & Orasanu, J. (2005). Identifying Psychosocial Stress in Team Interactions. Paper presented at the *15th International Astronautical Association Congress*, Graz, Austria.

- Fischer, U., McDonnell, L., & Orasanu, J. (2007). Linguistic correlates of team performance: Toward a tool for monitoring team functioning during space missions. *Aviat Space Environ Med*, 78(5), II, B86–95.
- Fischer, U., & Orasanu, J. (1999). Cultural diversity and crew communication. Presented at the 50th *International Astronautical Congress*, Amsterdam, Netherlands.
- Fischer, U., & Orasanu, J. (2003). *Do you see what I see? Effects of crew position on interpretation of flight problems*. Moffett Field, CA: National Aeronautics and Space Medicine, NASA/TM-2003-209612.
- Fischer, U., & Orasanu, J. (2000b). Error-challenging strategies: Their role in preventing and correcting errors. In *Proceedings of the 44th Annual Meeting of the Human Factors & Ergonomics Society* (pp. 30–33). Santa Monica, CA: Human Factors & Ergonomics Society.
- Fischer, U., Orasanu, J., & Davison, J. (2003). Why do airline pilots take risks? Insights from a think-aloud study. In *Proceedings: Human Factors of Decision Making in Complex Systems*, Dunblane, Scotland.
- Fischer, U., Orasanu, J., & Wich, M. (1995). Expert pilots' perceptions of problem situations. In R. S. Jensen & L. A. Rakovan (Eds.), Paper presented at the 8th International Symposium on Aviation Psychology (Vol. 2, pp. 777-778), Columbus, OH: Ohio State University.
- Fischer, U., Rinehart, M., & Orasanu, J. (2001). Training flight crews in effective error challenging strategies. Eleventh International Symposium on Aviation Psychology. Symposium Columbus, OH: Ohio State University.
- Fisher, S. (1984). Institutional authority and the structure of discourse. *Discourse Processes*, 7, 201-224.
- Fisher, D. & Pollatsek, A. (2007). Novice Driver Crashes: Failure to divide attention or failure to recognize risks. In A. Kramer, D. Wiegmann, and A. Kirlik (Ed.), *Attention: from theory to practice*. (pp. 134-156). Oxford UK: Oxford University Press.
- Fisk, A. D., Ackerman, P. L., & Schneider, W. (1987). Automatic and Controlled processing theory and its applications to human factors. In P. A. Hancock (Ed.). *Human Factors Psychology*. Amsterdam, The Netherlands: North-Holland.
- Fletcher, H. & Munson, W.A. (1933). Loudness, its definition, measurement and calculation. *J Acoust Soc Am*, 5, 82–108.
- Flin, R., & O'Connor, P. (2001). Applying crew resource management on offshore oil platforms. In E. Salas, C. A. Bowers, & E. Edens (Eds.), *Improving teamwork in organizations: Applications of resource management training* (pp. 217–234). Hillsdale, NJ: Lawrence Erlbaum Associates.
- Flynn, C. F. (2005). An operational approach to long-duration mission behavioral health and performance factors. *Aviat Space Environ Med*, 76(6), B42–51.
- Fortney, S. M., Mikhaylov, V., Lee, S. M., Kobzev, Y., Gonzalez, R. R., Greenleaf, J. E. (1998). Body temperature and thermoregulation during submaximal exercise after 115-day spaceflight. *Aviat Space Environ Med* 69: 137–141.
- Foushee, H. C., Lauber, J. K., Baetge, M. M., & Acomb, D. B. (1986). *Crew factors in flight operations: III. The operational significance of exposure to short-haul air transport operations* (NASA TM No. 88322). Moffett Field, CA: National Aeronautics and Space Administration.
- Fox, J. Personal communication, NASA Johnson Space Center, June 2003.

- Foyle, D. C., & Hooley, B. L., (Eds.). (2007). *Human performance modeling in aviation*. New York: CRC Press.
- Freed, M. (2000). *Reactive prioritization*. Paper presented at the 2nd NASA International Workshop on Planning and Scheduling in Space, San Francisco, CA.
- Freeman, G. L. (1933). The benefits of recategorization. facilitative and inhibitory effects of muscular tension on performance. *American Journal of Personality and Social Psychology*, 5745, 17–52.
- Fritsch-Yelle, J. M., Whitson, P. A., Bondar, R. L., Brown, T. E. (1996). Subnormal norepinephrine release relates to presyncope in astronauts after spaceflight. *J Appl Physiol* 81: 2134–41.
- Fuglesang, C., Narici, L., Picozza, P., & Sannita, W. G. (2006). Phosphenes in low earth orbit: survey responses from 59 astronauts. *Aviat Space Environ Med*, 77(4), 449-452, http://www.ncbi.nlm.nih.gov/entrez/query.fcgi?cmd=Retrieve&db=PubMed&dopt=Citation&list_uids=16676658
- Fussell, S. R., Kraut, R. E., & Siegel, J. (2000). Coordination of communication: Effects of shared visual context on collaborative work. *Proceedings of CSCW 2000* (pp. 21-30). NY: ACM Press.
- Gaertner, S., Fowler, B., Comfort, D, & Bock, O. (2000). A review of cognitive and perceptual-motor performance in space. *Aviat Space Environ Med*, 71, A66–A68.
- Gaertner, S. L., Mann, J., Murrell, A., & Dovidio, J. (1989). Reducing intergroup bias: The benefits of re-categorization. *Journal of Personality and Social Psychology*, 57, 239-249.
- Galton, F. (1899). On instruments for (1) testing perception of differences of tint and for (2) determining reaction time. *Journal of the Anthropological Institute*, 19, 27–29.
- Gawron, V. (2000). *Human Performance Measures Handbook*. Mahwah, NJ: Lawrence Erlbaum.
- Gawron, V.J. (2008). *Human Performance, Workload, and Situational Awareness Measures Handbook, 2nd ed.*, CRC Press, Taylor & Francis Group. Boca Raton, Florida.
- Gazzaniga, M., Ivry, R., & Mangun, G. (2002). Cognitive neuroscience: *The biology of the mind*. (2nd ed.). New York, NY: W.W. Norton & Company, Inc.
- Gegenfurtner, K. R., & Sharpe, L. T. (1999). Color vision: from genes to perception. Cambridge, New York, NY: Cambridge University Press.
- Gevens, A., & Smith, M. E. (2007). Electroencephalography (EEG) in neuroergonomics. In R. Parasuraman & M. Rizzo (Eds.), *Neuroergonomics* (pp. 15-31). Oxford, UK: Oxford University Press.
- Gilkey, R. H., & Anderson, T. R. (1997). *Binaural and spatial hearing in real and virtual environments*. Mahwah, NJ: Lawrence Erlbaum Associates.
- Gilligan, C. (1985). In a different voice: *Psychological theory and women's development*. Cambridge, MA: Harvard University Press.
- Gillingham K.K. and Wolfe, J.W. (1985). Spatial orientation in flight. In: Roy L. DeHart (Ed.) *Fundamentals of Aerospace Medicine*. Philadelphia, PA: Lea & Febiger.
- Ginis, H., Pérez, G. M., Bueno, J. M., & Artal, P. (2012). The wide-angle point spread function of the human eye reconstructed by a new optical method. *Journal of Vision*, 12(3), <http://journalofvision.org/12/3/20/>.
- Ginnett, R. C. (1987). The formation process of airline flight crews. In R.S. Jensen (Ed.), Paper presented at the *Proceedings of the 4th International Symposium on Aviation Psychology*, Columbus, Ohio. (399-405).

- Ginnett, R. C. (1993). Crew as groups: Their formation and their leadership. In E. Weiner, B. Kanki, & R. Helmreich (Eds.), *Cockpit Resource Management* (pp. 71–98). San Diego, CA: Academic Press.
- Glasauer, S., Amorim, M. A., Bloomberg, J. J., Reschke, M. F., Peters, B. T., Smith, S. L., Berthoz, A. (1995). Spatial orientation during locomotion following space flight. *Acta Astronautica* 36: 423-431.
- Gluck, K. A., & Pew, R. W. (Eds.). (2005). *Modeling human behavior with integrated cognitive architectures: Comparison, evaluation, and validation*. Mahwah, NJ: Lawrence Erlbaum Associates.
- Gopher, D., Wickens, C. D., (1977) Control theory measures of tracking as indices of attention allocation strategies. *Human Factors*, 19, 249-366.
- Gopher, D. (1992). The skill of attention control: Acquisition and execution of attention strategies. In S. Kornblum & D. Meyer (Eds.), *Attention and performance XIV*. Cambridge, MA: MIT Press.
- Gopher, D. (2007). Emphasis change in high demand task training. In A. Kramer, D. Wiegmann, & A. Kirlik (Eds.), *Attention: from theory to practice*. Oxford, UK: Oxford University Press.
- Gopher, D., & Donchin, E. (1986). Workload - An examination of the concept. In K. Boff, L. Kaufman, & J. P. Thomas (Eds.), *Handbook of Perception and Human Performance*. New York, NY: Wiley & Sons.
- Gore, B. F., Casner, S. M., Macramalla, S. R., Oyung, R., & Ahumada, A. (submitted). Workload and long-duration space mission performance in the system context, *Acta Astronautica*.
- Gore, B. F. & Jarvis, P. A. (2005). *New integrated modeling capabilities: MIDAS' recent behavioral enhancements* (SAW-2005-01-2701). Warrendale, PA: SAE International.
- Gore, B. F. & Corker, K. M. (2000). System interaction in free flight: A modeling tool cross-comparison. *SAE Transactions - Journal of Aerospace*, 108(1), 409–424.
- Gore, B. F. & Corker, K. M. (2001). Human performance modeling: A cooperative and necessary methodology for studying occupational ergonomics. In A. Bittner, P. Champney, & S. Morrissey (Eds.), *Ergonomics Principles, Models, and Methodologies: Advances in Occupational Ergonomics and Safety* (pp. 110–119). Amsterdam, The Netherlands: IOS Press.
- Gore, B. F. & Milgram, P. (2006). The conceptual development of a time estimation model to predict human performance in complex environments. *Ninth Proceedings of the Annual SAE International Conference and Exposition - Digital Human Modeling for Design and Engineering Conference*: (SAE Paper No. 2006-01-2344). Warrendale, PA: SAE International.
- Gore, B. F. & Smith, J. (2006). Risk assessment and human performance modeling: The need for an integrated systems approach. *International Journal of Human Factors Modelling and Simulation*, 1, 119–139.
- Gore, B. F., Hooey, B. L., Mahlstedt, E., & Foyle, D. C. (in press). (2012a). Extending validated human performance models to explore NextGen Concepts. In S. Landry & N. Stanton (eds.): *Transportation Modeling and Simulation, Applied Human Factors and Ergonomics (AHFE) LNCS XXXX*, pp. XXX–XXX, 2012.
- Gore, B.F., Hooey, B.L., Mahlstedt, E., & Foyle, D.C. (2012b). Evaluating NextGen Closely Spaced Parallel Approach Concepts with Validated Human Performance Models Flight Deck Guidelines (Part 2 of 2), In Human Centered Systems Lab (Ed.), *HCSL Technical Report*. Moffett Field, CA: NASA Ames Research Center.
- Gorman, J. C., Cooke, N. J., & Winner, J. L. (2006). Measuring team situational awareness in decentralized command and control environments. *Ergonomics*, 49, 1312–1325.

- Gorman, J. C., Cooke, N. J., Pedersen, H. K., Winner, J. L., Andrews, D., & Amazeen, P. G. (2006). Changes in team composition after a break: Building adaptive command-and-control teams, *Proceedings of the Human Factors & Ergonomics Society's 50th Annual Meeting* (Vol. 50, pp. 487-491): HFES.
- Gorman, J., Glasauer, S., & Mittelstaedt, H. (1998). Perception of spatial orientation in 0g. *Brain Res Brain Res Rev*, 28(1-2), 185–93.
- Greguras, G. J., Robie, C., Born, M. P., & Koenigs, R. J. (2007). A social relations analysis of team performance ratings. *International Journal of Selection and Assessment*, 15(4), 434–448.
- Grice, P. (1989). Logic and conversation. In P. Grice (Ed.), *Studies in the ways of words* (pp. 3-143). Cambridge, MA: Harvard University Press (Original work published in 1968).
- Griffin, M. J. (1990). *Handbook of Human Vibration*. London, UK: Academic Press.
- Guhe, M., Liao, W., Zhu, Z., Ji, Q., Gray, W. D., Schoelles, M. J. (2005). Non-intrusive measurement of workload in real-time. *Proceedings of the 49th Annual Meeting of the Human Factors and Ergonomics Society*, 1157–1161.
- Gutierrez, A., Gonzalez-Gross, M., Delgado, M., & Castillo, M. J. (2001). Three days fast in sportsmen decreases physical work capacity but not strength or perception-reaction time. *International Journal of Sport Nutrition and Exercise Metabolism*, 11, 420–429.
- Gutwin, C. & Greenberg, S. (2004). The importance of awareness for team cognition in distributed collaboration. In E. Salas, S. M. Fiore & J. A. Cannon-Bowers (Eds.), *Team Cognition: Process and Performance at the Inter- and Intra-Individual Level*. Washington, DC: APA Press.
- Guzzo, R. A. & Salas, E. (Eds.). (1995). *Team effectiveness and decision-making in organizations*. San Francisco, CA: Jossey-Bass.
- Guzzo, R. A., Jette, R. D., & Katzell, R. A. (1985). The effects of psychologically based intervention programs on worker productivity: A meta-analysis. *Personnel Psychology*, 38, 275–291.
- Gudykunst, W. B. & Ting-Toomey, S. (1988). *Culture and interpersonal communication*. Newbury Park, CA: Sage.
- Hackman, J. R. & Vidmar, N. (1970). Effects of size and task type on group performance and member reactions. *Sociometry*, 33, 37–54.
- Halford, G. S., Phillips, S., & Wilson, W. H., (1995). The processing of associations versus the processing of relations and symbols: A systematic comparison. In J. D. Moore & J. F. Lehman (Eds.), *Proceedings of the Seventeenth Annual Conference of the Cognitive Science Society*, pp. 688-691
- Halford, G. S., Andrews, G., Jensen, I., (2002) Integration of category induction and hierarchical classification: One paradigm at two levels of complexity. *Journal of Cognition and Development*, 3 (2), 143-177.
- Hambley, L. A., O'Neill, T. A., & Kline, T. J. B. (2007). Virtual team leadership: The effects of leadership style and communication medium on team interaction styles and outcomes. *Organizational Behavior and Human Decision Processes*, 103, 1–20.
- Hancock, P. A., & Chignell, M. H. (1988). Mental workload dynamics in adaptive interface design, *IEEE Transactions on Systems, Man, and Cybernetics* 18(4) 647-659.
- Hancock, P. A. & Desmond, P. A. (2001). *Stress, workload and fatigue*. Mahwah, NJ: Erlbaum.

- Hancock, P. A., & Meshkati, N. (Eds.). (1988). *Human mental workload*. Amsterdam, The Netherlands: North Holland Press.
- Hare, A. P. (1982). *Creativity in small groups*. Beverly Hills, CA: Sage.
- Hare, A. P., Blumberg, H. H., Davies, M. F., & Kent, M. V. (1994). *Small group research: A handbook*. Norwood, NJ: Ablex Pub. Corp.
- Harm, D. L., Parker, D. E., & Reschke, M. F. (1994). DSO 468: Preflight Adaptation Trainer. In *Results of life sciences DSOs conducted aboard the Shuttle, 1991-1993*, (pp. 27–43). Houston, TX: National Aeronautics and Space Administration.
- Harm, D. L., Reschke, M. F., & Parker, D. E. (1999). Section 5.2. Visual-vestibular integration motion perception reporting. In C. F. Sawin, G. R. Taylor, and W. L. Smith (Eds.) *Extended Duration Orbiter Medical Project 1989–1995* (NASA SP-1999-534). Washington, DC: National Aeronautics and Space Administration.
- Harper, R. P. and Cooper, G. E. (1984). Handling qualities and pilot evaluation. Proceedings of the AIAA, AHS, ASEE, Aircraft Design Systems and Operations Meeting, AIAA Paper 84-2442.
- Harris, R. M., Hill, S. G., & Lysaght, R. J. (1989). OWLKNEST: An expert system to provide operator workload guidance. In *Proceedings of the Human Factors Society 33rd Annual Meeting* (pp. 1486-1490). Santa Monica, CA: Human Factors Society.
- Harrison, A. A. (2001). *Spacefaring: The human dimension*. Berkeley, CA: University of California Press.
- Harrison, D. A., Price, K. H., Gavin, J. H., & Florey, A. T. (2002). Time, teams, and task performance: Changing effects of surface- and deep-level diversity on group functioning. *Academy of Management Journal*, 45, 1029–1045.
- Harrison, Y., & Horne, J. A. (1997). Sleep deprivation affects speech. *Sleep*, 20, 871–878.
- Harrison, Y., & Horne, J. A. (2000). The impact of sleep deprivation on decision making: A review. *Journal of Experimental Psychology Applied*, 6(3), 236–249.
- Hart, S. G. & Staveland, L. Development of the NASA task load index (TLX): Results of empirical and theoretical research, in: P. A. Hancock & N. Meshkati (Eds.), *Human Mental Workload*, North Holland, Amsterdam, pp. 239-250.
- Hart, S. G. & Staveland, L. E. (1988). Development of NASA-TLX (Task Load Index): Results of empirical and theoretical research. In P. A. Hancock & N. Meshkati (Eds.) *Human Mental Workload* (pp 139–183). Amsterdam, The Netherlands: North Holland.
- Hart, S. G. & Wickens, C. D. (1990). Workload Assessment and Prediction. In H. Booher (Ed.) *MANPRINT. An Approach to Systems Integration* (pp. 257–296). New York, NY: Van Nostrand.
- Hart, S.G. (1975). Time estimation as a secondary task to measure workload. In the 11th Annual Conference on Manual Control. Moffett Field, CA: NASA Ames Research Center, TM X-62, 464, May.
- Hart, S. G. (1986). Theory and Measurement of Human Workload. In J. Zeidner (Ed.), *Human Productivity Enhancement*. (pp. 396–56). New York, NY: Praeger.
- Hart, S. G. (2006). NASA-Task Load Index (NASA-TLX); 20 years later. In *Proceedings of the Human Factors & Ergonomics Society 50th Annual Meeting*. Santa Monica, CA: Human Factors and Ergonomics Society.

- Hart, S. G. & Hauser, J. R. (1987). Inflight application of three pilot workload measurement techniques. *Aviat Space Environ Med*, 58(5), 402–410.
- Hart, S. G., Dahn, D., Atencio, A., & Dalal, K. M. (2001). *Evaluation and Application of MIDAS v2.0* (2001-01-2648). Warrendale, PA: SAE International.
- Hart, S. G., McPherson, D., & Loomis, L. L. (1978). Time estimation as a secondary task to measure workload: Summary of research (NASA-CP2060). In *Proceedings of the 14th Annual Conference on Manual Control* (pp. 693-712). Washington, DC: National Aeronautics and Space Administration.
- Hart, S. G. (1993). Workload Factors. In C. D. Wickens, & B. M. Huey (Eds.), *Teams in Transition*. Washington, DC: National Academy Press.
- Hart, S. G., Wickens, C. D. (2008). Mental workload. In *NASA Human Systems Integration Design Handbook*, National Aeronautics and Space Administration, Washington, DC.
- Hartmann, W. M. (1998). *Signals, sound, and sensation*. New York, NY: Springer-Verlag.
- Hartzell, E. J. (1979). Helicopter pilot performance and workload as a function of night vision symbologies. In *Proceedings of the 18th IEEE Conference on Decision and Control*, 995-996. Fort Lauderdale, FL, December 1979.
- Harville, D. L., Barnes, C., & Elliott, L. R. (2004). Team communication and performance during sustained command and control operations: Preliminary results (AFRL-HE-BE-TR-2004-0018), Brooks City-Base, TX, Biosciences and Protection Division, Air Force Research Laboratory, Human Effectiveness Directorate.
- Heath, S. B. (1983). *Ways with words: Language, life and work in communities and classrooms*. Cambridge, UK: Cambridge University Press.
- Hecht, S. & Shlaer, S. (1936). Intermittent stimulation by light. V. The relation between intensity and critical fusion frequency for different parts of the spectrum. *J Gen Physiol*, 19, 965–977.
- Heinicke, C. & Bales, R. F. (1953). Developmental trends in the structure of small groups. *Sociometry*, 16, 7–38.
- Helleberg, J. & Wickens, C. D. (2003). Effects of data-link modality and display redundancy on pilot performance: An attentional perspective. *The International Journal of Aviation Psychology*, 13(3), 189–210.
- Helmreich, R. L. & Foushee, C. H. (1993). Why crew resource management? Empirical and theoretical bases of human factors training in aviation. In E. Weiner, B. Kanki & R. Helmreich (Eds.), *Crew resource management* (pp. 3–41). San Diego, CA: Academic Press.
- Helmreich, R. L., Klinect, J. R., & Wilhelm, J. A. (2001). System safety and threat and error management: The line operational safety audit (LOSA). *11th International Symposium on Aviation Psychology*. Columbus, OH: Ohio State University.
- Helmreich, R. L. & Merritt, A. (1998). *Culture at work in aviation and medicine: National, organizational and professional influences*. Aldershot, UK: Ashgate.
- Helmreich, R. L. & Sexton, J. B. (2004). Group interaction under threat and high workload. In R. Dietrich & T. M. Childress (Eds.). *Group interaction in high-risk environments* (pp. 9–23). Burlington, VT: Ashgate Publishing.
- Hersey, P., Angelini, A. L., & Carakushansky, S. (1982). The impact of situational leadership and classroom structure on learning effectiveness. *Group and Organizational Studies*, 7(2), 216–224.

- Herrick, R. M. (1974). Foveal light-detection thresholds with two temporally spaced flashes: A review. *Perception and Psychophysics*, 15(2), 361–367.
- Hick, W. E. (1952). On the rate of gain of information. *Quarterly Journal of Experimental Psychology*, 4:11-26.
- Hill, S. G., Iavecchia, H. P., Byers, J. C., Bittner, A. C., Zaklad, A. L., & Christ, R. E. (1992). Comparison of four subjective workload rating scales. *Human Factors*, 34, 429–439.
- Hirschfeld, R. R., Jordan, M. H., Feild, H. S., Giles, W. F., & Armenakis, A. A. (2006). Becoming team players: Team members mastery teamwork knowledge as a predictor of team task proficiency and observed teamwork effectiveness. *Journal of Applied Psychology*, 91(2), 467-474.
- Hockey, G. R. J. (1970). Effect of loud noise on attentional selectivity. *The Quarterly Journal of Experimental Psychology*, 22(1), 28–36.
- Hockey, G. R. J. (1986). Changes in operator efficiency as a function of environmental stress, fatigue, and circadian rhythms. In K. R. Boff, L. Kaufman, & J. P. Thomas (Eds.), *Handbook of Perception and Human Performance*. New York, NY: Wiley/Interscience.
- Hoffman, D. D. (1998). *Visual intelligence: How we create what we see*. New York, NY: W. W. Norton and Company, Inc.
- Hoffman, J. E. & Subramaniam, B. (1995). The role of visual attention in saccadic eye movements. *Perception and Psychophysics*, 57, 787–795.
- Hofstede, G. (1980). *Culture's consequences: International differences in work-related values*. Beverly Hills, CA: Sage Publications.
- Hogan, R., Curphy, G. J., & Hogan, J. (1994). What we know about leadership: Effectiveness and personality. *American Psychologist*, 49(6), 493–504.
- Hogan, R. & Kaiser, R. B. (2005). What we know about leadership. *Review of General Psychology*, 9(2), 169–180.
- Holland, A. W. (1997). Culture, gender and mission accomplishment: Mission Accomplishment: Operational Experience. In: *12th Man in Space Symposium 89*, Washington, DC.
- Holland, A. W. (1998). Chapter 7: Space psychology. In W. J. Larson (Ed.), *Human Space Systems: Mission Analysis and Design*. Alexandria, VA: U.S. Department of Defense.
- Hollingshead, A. B. (1998). Communication, learning and retrieval in transactive memory systems. *Journal of Experimental Social Psychology*, 34, 423–442.
- Hollingshead, A. B. (2000). Perceptions of expertise and transactive memory in work relationships. *Group Processes and Intergroup Relations*, 3, 257–267.
- Holtgraves, T. & Yang, J.-N. (1992). Interpersonal underpinnings of request strategies: General principles and differences due to culture and gender. *Journal of Personality and Social Psychology*, 62, 246–256.
- Hood, D. C. & Finkelstein, M. A. (1986). Sensitivity to light. In K. Boff, L. Kaufman, & J. Thomas (Eds.), *Handbook of perception and human performance*, Chapter 5. New York, NY: Wiley.
- Horowitz, S. K. & Horowitz, I. B. (2007). The effects of team diversity on team outcomes: A meta-analytic review of team demography. *Journal of Management*, 33, 987–1015.
- Horrey, W. J. & Wickens, C. D. (2003). Multiple resource modeling of task interference in vehicle control, hazard awareness and in-vehicle task performance. *Proceedings of the Second International*

- Driving Symposium on Human Factors in Driver Assessment, Training, and Vehicle Design*, Park City, Utah, 7-12.
- Howard, I. P. & Templeton, W. B. (1966). *Human Spatial Orientation*. New York, NY: Wiley.
- Howard, I. P. (1982). *Human Visual Orientation*. New York, NY: Wiley.
- Howes, A. & Young, R. M. (1996). Learning consistent, interactive, and meaningful task-action mappings: A computational model. *Cognitive Science: A Multidisciplinary Journal*, 20, 301–356.
- Howes, A. & Young, R. M. (1997). The role of cognitive architecture in modeling the user: Soar's learning mechanism. *Human-Computer Interaction*, 12(4), 311–343.
- Hsieh, S. (2002). Two-component processes in switching attention: A study of event-related potentials. *Perceptual and Motor Skills*, 94, 1168–1176.
- Hui, C. H. & Triandis, H. C. (1986). Individualism-collectivism: A study of cross-cultural research. *Journal of Cross-Cultural Psychology*, 17, 225–248.
- Hunt, R. W. G. (2004). *The Reproduction of Colour* (6th ed.). West Sussex, England: John Wiley & Sons Ltd.
- Indik, B. P. (1965). Operational size and member of participation: Some empirical tests of alternative explanations. *Human Relations*, 18, 339–350.
- Isenberg, D. J., & Ennis, J. G. (1981). A comparison of derived and imposed dimensions. *Journal of Personality and Social Psychology*, 41(2), 293–305.
- Jackson, S. International Standards Organization. (1996). ISO 389-7:1996 Reference zero for the calibration of audiometric equipment -- Part 7: Reference threshold of hearing under free-field and diffuse-field listening conditions. Geneva. International Standards Organization.
- International Standards Organization. (2003). ISO 226:2003 Acoustics -- Normal equal-loudness-level contours. International Standards Organization.
- Itoh, M., Abe, G., & Tanaka, K. (1999). Trust in and use of automation: Their dependence on occurrence patterns of malfunctions. *Proceedings of the IEEE SMC Conference: Systems, Man, and Cybernetics*. 3, 715-720. Tokyo, Japan.
- Jackson, S. E., Joshi, A., & Erhardt, N. L. (2003). Recent research on team and organizational diversity: SWOT analysis and implications. *Journal of Management*, 29, 801–830.
- Jaffe, E. D., & Nebenzahl, I. D. (1990). Group interaction and business game performance. *Simulation & Gaming*, 21(2), 133–146.
- Janis, I. L. (1982). *Groupthink: Psychological studies of policy decisions and fiascos*. Boston, MA: Houghton Mifflin.
- Jehn, K. A. (1994). Enhancing effectiveness: An investigation of advantages and disadvantages of value-based intragroup conflict. *International Journal of Conflict Management*, 5, 223–238.
- Jehn, K. A. (1995). A multimethod examination of benefits and detriments of intragroup conflict. *Administrative Science Quarterly*, 40, 256–282.
- Jehn, K. A., Northcraft, G. B., Neale, M. A. (1999), Why differences make a difference: a field study of diversity, conflict, and performance in workgroups, *Administrative Science Quarterly*, Vol. 44 pp. 741-63.

- John, O. P. & Srivastava, S. (1999). The Big Five trait taxonomy: History, measurement, and theoretical perspectives. In L. A. Pervin & O. P. John (Eds.), *Handbook of personality: Theory and research* (pp. 102-138). New York, NY: Guilford Press.
- Jex, H., McDonnell, J., Phatak, A., (1966). A "critical" tracking task for man-machine research related to the operator's effective delay time. Part I: Theory and experiments with a first order divergent controlled element. NASA CR-616.
- Jex, H., McDonnell, W., & Phatak, A. (1966). A critical tracking task for manual control research. *IEEE Transaction on Human Factors in Electronics*, Vol. HFE-7(4), pp 138-145.
- Johnson, M. K., Hashtroudi, S., & Lindsay, D. S. (1993). Source monitoring. *Psychological Bulletin*, 114, 3–28.
- Judge, T. A., Bono, J. E., Ilies, R., & Gerhardt, M. W. (2002). Personality and leadership: A qualitative and quantitative review. *J Appl Psychol*, 87, 765–780.
- Just, M., Carpenter, P. A., & Miyake, A. (2003). Neuroindices of cognitive workload: Neuroimaging, pupillometric and event-related brain potential studies of brain work. *Theoretical Issues in Ergonomics Science*, 4, 56–88.
- Kaber, D. B. and Endsley, M. R. (2004). The effects of level of automation and adaptive automation on human performance, situation awareness and workload in a dynamic control task. *Theoretical Issues in Ergonomics Science*, 5(2), 113–153.
- Kaehler, R. and Meehan, J. P. (1960). Human psychomotor performance under varied transverse accelerations. Wright Air Development Division. Wright-Patterson AFB, Ohio, TR-60-621.
- Kahneman, D. (1973). *Attention and effort*. Englewood Cliffs, NJ: Prentice-Hall.
- Kahn-Greene, E. T., Lipizzia, E. L., Conrada, A. K., Kamimoria, G. H., & Killgore, W. D. S. (2006). Sleep deprivation adversely affects interpersonal responses to frustration. *Personality and Individual Differences*, 41(8), 1433–1443.
- Kaiser, M. K. & Ahumada Jr., A. J. (2008). Perceptual challenges of lunar operations, International Conference on Environmental Systems, SAE International Paper 2008-01-2108, San Francisco, CA.
- Kaiser, P. K. & Boynton, R. M. (1996). *Human color vision* (2nd ed.). Washington, DC: Optical Society of America.
- Kalsbeek & Sykes (1966) (incomplete reference).
- Kanas, N. (2005). Interpersonal issues in space: Shuttle/Mir and beyond. *Aviat Space Environ Med*, 76(6), B126–134.
- Kanas, N. (2009). *Psychology and culture during long duration space missions*. Paris, France: International Academy of Astronautics.
- Kanas, N. & Manzey, D. (2003). *Space psychology and psychiatry*. El Segundo, CA: Microcosm Press.
- Kanas, N. & Manzey, D. (2008). *Space psychology and psychiatry* (2nd ed.). El Segundo, CA: Microcosm Press.
- Kanas, N. & Ritsher, J. B. (2005). Leadership issue with multicultural crews on the International Space Station: Lessons learned from Shuttle/Mir. *Acta Astronautica*, 56, 932–936.
- Kanas, N., Salnitskiy, V., Grund, E., M., Weiss, D. S., Gushin, V., Bostrom, A., et al. (2001). Psychosocial issues in space: Results from Shuttle/Mir. *Gravitational and Space Biology Bulletin*, 14(2), 35–45.

- Kanas, N., Salnitskiy, V., Ritsher, J., Gushin, V., Weiss, D., Saylor, S., Marmar, C. (2005). Crew and ground interactions during ISS missions: Background and Panel Overview. *76th Annual Scientific Meeting: Charting the Course for the Future*, Kansas City, MO, Aerospace Medical Association. *Aviation, Space and Environmental Medicine*, 76(3), 293.
- Kanki, B. G. & Foushee, H. C. (1989). Communication as group process mediator of aircrew performance. *Aviat Space Environ Med*, 60, 402–410.
- Kanki, B. G., Lozito, S., & Foushee, H. C. (1989). Communication indices of crew coordination. *Aviat Space Environ Med*, 60, 56–60.
- Karsenty, L. (1999). Cooperative work and shared visual context: An empirical study of comprehension problems and in side-by-side and remote help dialogues. *Human-Computer Interaction*, 14, 283-315.
- Kantowitz, B. H., Bortolussi, M. R., & Hart, S. G. (1987). Measuring pilot workload in a motion base simulator: III. Synchronous secondary tasks. *Proceedings of the Human Factors Society*, 31, 834-837.
- Kass, R. & Kass, J. (1995). Group dynamics training for manned spaceflight and the CAPSULES experiment: Prophylactic against incompatibility and its consequences? *Acta Astronautica*, 36(8-12), 567–573.
- Katayama, K., Sato, K., Akima, H., Ishida, K., Takada, H., Watanabe, Y., Iwase, M., Miyamura, M., Iwase, S. (2004). Acceleration with exercise during head-down bed rest preserves upright exercise responses. *Aviat Space Environ Med* 75: 1029–1035.
- Katz, D. (1949). Morale and motivation in industry. In W. Dennis (Ed.), *Current trends in industrial psychology* (pp. 145–171). Pittsburgh, PA: University of Pittsburgh Press.
- Kay, G. G. (1995). *CogScreen aeromedical edition: Professional manual*. Odessa, FL: Psychological Assessment Resources.
- Kealey, D. J. (2004). Research on intercultural effectiveness and its relevance to multicultural crews in space. *Aviat Space Environ Med*, 75(7), C58–64.
- Kealey, D. J. & Protheroe, D. R. (1996). The effectiveness of cross-cultural training for expatriates: An assessment of the literature on the issue. *International Journal of Intercultural Relations*, 20, 141–165.
- Keinan, G. (1987). Decision making under stress: Scanning of alternatives under controllable and uncontrollable threats. *Journal of Personality and Social Psychology*, 52, 639–644.
- Keinan, G. (1988). Training for dangerous task performance: The effects of expectations and feedback. *Journal of Applied Social Psychology*, 18(4, pt. 2), 355–373.
- Kelly, A. D. & Kanas, N. (1992). Crewmember communication in space: A survey of astronauts and cosmonauts. *Aviat Space Environ Med*, 63, 721–726.
- Kelsey, B. L. (1998). The dynamics of multicultural groups: Ethnicity as a determinant of leadership. *Small Group Research*, 29, 602–623.
- Kemp, B. J. (1973). Reaction time of young and elderly subjects in relation to perceptual deprivation and signal-on versus signal-off condition. *Developmental Psychology* 8, 268–272.
- Keyton, J. (1999). Relational communication in groups. In L. R. Frey (Ed.), *The handbook of group communication theory and research* (pp. 192–222). Thousand Oaks, CA: Sage Publications.
- Keyton, J. & Springston, J. (1990). Redefining cohesiveness in groups. *Small Group Research*, 21(2), 234–254.

- Kiekel, P. A., Cooke, N. J., Foltz, P. W., Gorman, J., & Martin, M. (2002). Some promising results of communication-based automatic measures of team cognition. *Proceedings of the Human Factors and Ergonomics Society 45th Annual Meeting*, 298–302. Baltimore, MD.
- Kieras, D. E. & Meyer, D. E. (1997). An overview of the EPIC architecture for cognition and performance with application to human-computer interaction. *Human-Computer Interaction*, 12(4 [Special issue: Cognitive Architectures and Human-Computer Interaction]), 391–438.
- Kieras, D. E., Meyer, D. E., Mueller, S., & Seymour, T. (1998). *Insights into working memory from the perspective of the EPIC architecture for modeling skilled perceptual-motor and cognitive human performance*. Fort Belvoir, VA: US Department of Defense, Defense Technical Information Center.
- Kieras, D. E., Woods, S. D., & Meyer, D. E. (1997). Predictive engineering models based on the EPIC architecture for a multimodal high-performance human-computer interaction task. *ACM Transactions on Computer-Human Interaction*, 4, 230–275.
- Kiesler, S. & Cummings, J. N. (2002). What do we know about proximity and distance in work groups? A legacy of research. In P. Hinds & S. Kiesler (Eds.), *Distributed work* (pp. 57–80). Cambridge, MA: MIT Press.
- Kiris, E. O. (1995). The out of the loop performance problem and level of control in automation. *Human Factors*, 37(2), 381-394.
- Kitayama, S., Duffy, S., Kawamura, T., & Larsen, J. T. (2003). Perceiving an object and its context in different cultures: A cultural look at new look. *Psychological Science*, 14(3), 201–206.
- Klein, G. A. (1993). A recognition-primed decision (RPD) model of rapid decision making. In Klein, G. A., Orasanu, J., Calderwood, R., Zsombok, C. (Eds.), *Decision making in action: Models and methods* (pp. 138–147). Norwood, NJ: Ablex.
- Klein, G. (1996). The effect of acute stressors on decision making. In J. E. Driskell & E. Salas (Eds.) *Stress and human performance* (pp. 49–88). Hillsdale, NJ: Lawrence Erlbaum Associates.
- Klein, G. (1998). *Sources of power: How people make decisions*. Cambridge, MA: MIT Press.
- Klein, G. (2001). Features of team coordination. In M. D. McNeese, E. Salas, & M. Endsley (Eds.), *New trends in cooperative activities: Understanding system dynamics in complex environments*. Santa Monica, CA: Human Factors & Ergonomics Society.
- Klein, G. (2004). *The power of intuition: How to use your gut feelings to make better decisions at work*. New York, NY: Random House, Inc.
- Klein, G. A. (1989). Recognition-primed decisions. In W. B. Rouse (Ed.), *Advances in man-machine system research* (Vol. 5, pp. 47–92). Greenwich, CT: JAI Publishers.
- Klein, G., Wolf, S., Militello, L., & Zsombok, C. (1995). Characteristics of skilled option generation in chess. *Organizational Behavior and Human Decision Processes*, 62(1), 63–69.
- Kleinman, D. L., Luh, P. B., Pattipati, K. R., & Serfaty, D. (1992). Mathematical models of team performance: A distributed decision-making approach. In R. W. Swezey & E. Salas (Eds.), *Teams: Their training and performance* (pp. 177–218). Norwood, NJ: Ablex.
- Klinect, J. R., Wilhelm, J. A., & Helmreich, R. L. (1999). Threat and error management: Data from line operations safety audits. In *Proceedings of the Tenth International Symposium on Aviation Psychology* (pp. 683-688). Columbus, OH: The Ohio State University.
- Kobrick, R. (2007, May). FMARS 2007 Crew Reports - Human Factors Report. <http://www.marssociety.org/arctic/report-individual.php?id=2007-05-26-hum.inc>

- Koenderink, J. J., & van Doorn, A. J. (1979). Spatiotemporal contrast detection threshold surface is bimodal. *Optics Letters*, 4, 32–34.
- Koenderink, J. J., Bouman, M. A., Mesquita, A. E. B. d., & Slappendel, S. (1978). Perimetry of contrast detection thresholds of moving spatial sine wave patterns. I. The near peripheral visual field (eccentricity 0°-8°). *J Opt Soc Amer*, 68, 845–849.
- Kowler, E., & McKee, S. P. (1987). Sensitivity of smooth eye movement to small differences in target velocity. *Vision Res*, 27(6), 993–1015.
- Kowler, E., Anderson, E., Doshier, B., & Blaser, E. (1995). The role of attention in the programming of saccades. *Vision Res*, 35, 1897–1916.
- Kozerenko, O. P., Gushin, V. I., Sled, A. D., Efimov, V. A., & Pystinnikova, J. M. (1999). Some problems of group interaction in prolonged space flights. *Human Performance in Extreme Environments*, 4(1), 123–127.
- Kraiger, K., & Wenzel, L. H. (1997). Conceptual development and empirical evaluation of measures of shared mental models as indicators of team effectiveness. In M. T. Brannick, E. Salas & C. Prince (Eds.), *Team performance assesement and measurement: Theory, methods, and applications* (pp. 63-84). Mahwah, NJ: Lawrence Erlbaum Associates.
- Kramer, A. F. & Parasuraman, R. (2008). Neuroergonomics: Application of neuroscience to human factors. In J. T. Cacioppo, L. G. Tassinary, & G. G. Berntson (Eds.), *Handbook of psychophysiology*. Cambridge, UK: Cambridge University Press
- Kramer, A., Wickens, C. D., & Donchin, E. (1983). An analysis of the processing requirements of a complex perceptual motor task. *Human Factors*, 5, 597–621.
- Kramer, A. F., Sirevaag, E. J., & Braune, R. (1987). A psychophysiological assessment of operator workload during simulated flight missions. *Human Factors*, 29 (2), 145–160.
- Kramer, G. (Ed.). (1994). *Auditory display: Sonification, audification, and auditory interfaces*. Reading, MA: Addison-Wesley.
- Kramer, L. A., Sargsyan, A. E., Hasan, K. M., Polk, J. D., & Hamilton, D. R. (2012). Orbital and Intracranial Effects of Microgravity: Findings at 3-T MR Imaging. Radiology, doi: 10.1148/radiol.12111986.
- Krantz, J. H., Silverstein, L. D., & Yeh, Y. Y. (1992). Visibility of transmissive liquid crystal displays under dynamic lighting conditions. *Human Factors*, (34), 615-632.
- Krauss, R. M. & Bricker, P. D. (1966). Effects of transmission delay and access delay on the efficiency of verbal communication. *Journal of the Acoustical Society*, 4, 286-292.
- Kraut, R. E., Fussell, S. R., Brennan, S. E., & Siegel, J. (2002). Understanding effects of proximity on collaboration: Implications for technologies to support remote collaborative work. In P. Hinds & S. Kiesler (Eds.), *Distributed Work* (pp. 137–162). Cambridge, MA: MIT Press.
- Krukowski, A. E. & Stone, L.S. (2005). Expansion of direction space around the cardinal axes revealed by smooth pursuit eye movements. *Neuron*, 45, 315–23.
- Krukowski, A. E., Pirog, K. A., Beutter, B. R., Brooks, K. R., & Stone, L.S. (2003). Human discrimination of visual direction of motion with and without smooth pursuit eye movements. *Journal of Vision*, 3, 831–40.

- Lackner, J. R., & Graybiel, A. (1985). Head movements elicit motion sickness during exposure to 0g and microgravity acceleration levels. In M. Igarashi & F. O. Black (Eds.) *Vestibular and Visual Control on Posture and Locomotor Equilibrium* (pp. 170-176). Basel, Switzerland: Karger.
- Lange, K. E., Perka, A. T., Duffield, B. E., & Jeng, F. F. (2005). Bounding the spacecraft atmosphere design space for future exploration missions, NASA/CR-2005-213689. Houston, TX: National Aeronautics and Space Administration.
- LaPorte, T. R. & Consolini, P. M. (1991). Working in practice but not in theory: Theoretical challenges of “high-reliability organizations.” *Journal of Public Administration Research and Theory: J-PART*, 1(1), 19–48.
- Laughery, K. R., LeBiere, C., & Archer, S. (2006). Modeling human performance in complex systems. In G. Salvendy (Ed.), *Handbook of human factors and ergonomics* (3rd ed., pp. 965-996). Hoboken, NJ: Wiley.
- Layne, C. S., McDonald, P. V., Bloomberg, J. J. (1997). Neuromuscular activation patterns during treadmill walking after space flight. *Exp Brain Res*. 113: 104-116.
- Layne, C. S., Mulavara, A. P., McDonald, P. V., Pruett, C. J., Kozlovskaya, I. B., Bloomberg, J. J. (2004). Alterations in human neuromuscular activation during overground locomotion after long-duration spaceflight. *Journal of Gravitational Physiology* 11: 1-16.
- Lazarus, R. S., & Folkman, S. (1984). *Stress, appraisal and coping*. New York, NY: Springer.
- Leach, C. S., Alfrey, C. P., Suki, W. N., Leonard, J. I., Rambaut, P. C., Inners, L. D., Smith, S. M., Lane, H. W., Krauhs, J. M. (1996). Regulation of body fluid compartments during short-term spaceflight. *J. Appl. Physiol* 81: 105–116.
- Lebiere, C. (2002). Modeling group decision making in the ACT-R cognitive architecture. In *Proceedings of the 2002 Computational Social and Organizational Science*. June 21-23, Pittsburgh, PA.
- Lee, J. D., Caven, B., Haake, S., & Brown, T. L. (2001). Speech-based interaction with in-vehicle computers: The effect of speech-based e-mail on drivers’ attention to the roadway. *Human Factors*, 43, 631–640.
- Lee, S. M. C., Moore, A. D., Everett, M. E., Stenger, M. B., Platts, S. H. (2010). Aerobic exercise deconditioning and countermeasures during bed rest. *Aviat Space Environ Med* 81: 52–63.
- Lee, S. M. C., Schneider, S. M., Boda, W. L., Watenpaugh, D. E., Macias, B. R., Meyer, R. S., Hargens, A. R. (2009). LBNP exercise protects aerobic capacity and sprint speed of female twins during 30 days of bed rest. *J. Appl. Physiol* 106: 919–928.
- Lee, S. M., Shackelford, L. C., Smith, S. M., Guilliams, M. E., Shepherd, B., Loehr, J. A., Laughlin, M. S., Chauvin, J., & Hagan, R.D. (2004). Lean Tissue Mass and Muscle Strength: Does Resistive Exercise During Space Flight Prevent Deconditioning? *Medicine and Science in Sports and Exercise*. 36(5), S272.
- Lee, S. M. C., Williams, W. J., Schneider, S. M. (2002). Role of skin blood flow and sweating rate in exercise thermoregulation after bed rest. *J. Appl. Physiol* 92: 2026–2034.
- Leedom, D. K., & Simon, R. (1995). Improving team coordination: A case for behavior-based training. *Military Psychology*, 7(2), 109–122.
- Legge, G. E., & Foley, J. M. (1980). Contrast masking in human vision. *J Opt Soc Am A*, 70(12), 1458–1471.

- Legge, G. E., Rubin, G. S., & Luebker, A. (1987). Psychophysics of reading--V. The role of contrast in normal vision. *Vision Res*, 27(7), 1165–1177, <http://www.ncbi.nlm.nih.gov/htbin-post/Entrez/query?db=m&form=6&dopt=r&uid=0003660667>.
- Leon, G. R. (2005). Men and women in space. *Aviat Space Environ Med*, 76(6), B84–88.
- Leon, G. R., Atlis, M. M., Ones, D. S., & Magor, G. (2002). A 1-year, three-couple expedition as a crew analog for a Mars mission. *Environment and Behavior*, 34, 672–700.
- Leon, G. R. & Sandal, G. M. (2003). Women and couples in isolated extreme environments: Applications for long-duration missions. *Acta Astronautica*, 53, 259–267.
- Levine, B. D., Lane, L. D., Watenpaugh, D. E., Gaffney, F. A., Buckey, J. C., Blomqvist, C. G. (1996). Maximal exercise performance after adaptation to microgravity. *J. Appl. Physiol.* 81: 686–694.
- Levine, J. M. & Moreland, R. L. (1998). Small groups. In D. T. Gilbert, S. T. Fiske & G. Lindzey (Eds.), *The handbook of social psychology* (4th ed., Vol. 2, pp. 415–469). Boston, MA: McGraw-Hill.
- Lewis, R. L. (1996) Interference in short-term memory: The magical number two (or three) in sentence processing. *Journal of Psycholinguistic Research*, 25, 93–115.
- Lewis, R. L. (1997a). Leaping off the garden path: Reanalysis and limited repair parsing. In J. Fodor & F. Ferreira (Eds), *Reanalysis in Sentence Processing*. Boston, MA: Kluwer.
- Lewis, R. L. (1997b). Specifying architectures for language processing: Process, control, and memory in parsing and interpretation. In M. Crocker, M. Pickering, & C. Clifton (Eds), *Architectures and Mechanisms for Language Processing*. Cambridge, UK: Cambridge University Press.
- Li, L., Sweet, B. T., & Stone, L. S. (2006). Active control with an isoluminant display. *IEEE Transactions on Systems, Man, and Cybernetics*, 36, 1124–1134.
- Li, L., Sweet, B. T., & Stone, L. S. (2005). Effect of contrast on the active control of a moving line. *J Neurophysiol*, 93, 2873–86.
- Li, L., Chen, J., & Peng, X. Z. (2007). Influence of field of view (FOV) size and depth range on heading perception with or without visual path information. *Perception*, 36S, 184.
- Lieberman, P., Morey, A., Hochstadt, J. E., Larson, M., & Mather, S. (2005). Mount Everest: A space-analog for speech monitoring of cognitive deficits and stress. *Aviat Space Environ Med*, 76(6), Suppl. B198–207.
- Linde, C. (1988). The quantitative study of communicative success: Politeness and accidents in aviation discourse. *Language in Society*, 17, 375–399.
- Linenger, J. M. (2000). *Off the Planet: Surviving Five Perilous Months Aboard the Space Station Mir*. New York, NY: McGraw-Hill.
- Lintern, G. & Wickens, C. D. (1991). Issues for acquisition in transfer of timesharing and dual-task skills. In D. Damos (Ed.), *Multiple-task performance* (pp. 123–138). London, UK: Taylor & Francis.
- Lipshitz, R., Klein, G., Orasanu, J., & Salas, E. (2001). Taking stock of naturalistic decision making. *Journal of Behavioral Decision Making*, 14, 331–352.
- Liston, C., McEwen, B. S., & Casey, B. J. (2009). Psychosocial stress reversibly disrupts prefrontal processing and attentional control. *Proceedings of the National Academy of Sciences*, 106(3), 912–917.
- Logan, G. D. (1985). Skill and automaticity. *Canadian Journal of Psychology*, 9, 283–286.

- Lorist, M. M., & Snel, J. (1997). Caffeine effects on perceptual and motor processes. *Electroencephalography and Clinical Neurophysiology*, 102, 401–413.
- Lovelace, K., Shapiro, D. L., & Weingart, L. R. (2001). Maximizing cross functional new product teams' innovativeness and constraint adherence: A conflict communications perspective. *Academy of Management Journal*, 44, 779–783.
- Lubin, J. (1993). The use of psychophysical data and models in the analysis of display system performance. In A. B. Watson (Ed.), *Digital images and human vision* (pp. 163–178). Cambridge, MA: MIT Press.
- Luethi, M., Meier, B., & Sandi, C. (2008). Stress effects on working memory, explicit memory, and implicit memory for neutral and emotional stimuli in healthy men. *Frontiers in Behavioral Neuroscience*. 2(5), (129-1360). Epub 2009 Jan 15.
- Lulofs, R., Wennekens, R., & Van Houtem, J. (1981). Effect of physical stress and time-pressure on performance. *Perceptual and Motor Skills*, 52(3), 787–793.
- Lysaght, R. J., Hill, S. G., Dick, A O., Plamondon, B. D., Linton, P. M., Wierwille, W. W., Zaklad, A. L., Bittner, A C., & Wherry, R. J. (1989). *Operator workload: Comprehensive Review and Evaluation of Operator Workload Methodologies* (TR 851). Alexandria, VA: US Army Research Institute for the Behavioral and Social Sciences.
- MacCoun, R. J. (1993). Unit cohesion and military performance. In *Sexual orientation and U.S. military personnel policy: Policy options and assessment* (pp. 283–331). Santa Monica, CA: RAND
- Madan, A., Caneel, R., & Pentland, A. (2004). GroupMedia: Distributed multimodal interfaces. Paper presented at the 6th International Conference on Multimodal Interfaces, State College, PA.
- Mader, T. H., Gibson, C. R., Pass, A. F., Kramer, L. A., Lee, A. G., Fogarty, J., et al. (2011). Optic Disc Edema, Globe Flattening, Choroidal Folds, and Hyperopic Shifts Observed in Astronauts after Long-duration Space Flight. *Ophthalmology*, 118(10), 2058-2069.
- Mandler, G. (1982). Stress and thought processes. In L. Goldberger & S. Breznitz (Eds.), *Handbook of stress: Theoretical and clinical aspects*. New York, NY: Free Press.
- Mannix, E., & Neale, M. A. (2005). What differences make a difference? The promise and reality of diverse teams in organizations. *Psychological Science in the Public Interest*, 6, 31–55.
- Manzey, D, Lorenz, B, Schiewe, A, Finell, G, & Thiele, G. (1995). Dual-task performance in space: Results from a single-case study during a short-term space mission. *Human Factors*, 37 (4), 667–681.
- Manzey, D. (2000) Monitoring of mental performance during spaceflight. *Aviat Space Environ Med*, 71, A69–A75.
- Manzey, D. (2004) Human missions to Mars: new psychological challenges and research issues. *Acta Astronautica*, 55, 781-790.
- Mark, G. (2002). Conventions for coordinating electronic distributed work: A longitudinal study of groupware use. In P. Hinds & S. Kiesler (Eds.), *Distributed Work* (pp. 259–282). Cambridge, MA: MIT Press.
- Markus, H. R. & Kitayama, S. (1991). Culture and the self: Implications for cognition, emotion and motivation. *Psychological Review*, 98, 224–253.
- Markus, H. R. & Lin, L. R. (1999). Conflictways: Cultural diversity in the meanings and practices of conflict. In D. A. Prentice & D. T. Miller (Eds.), *Cultural divides: Understanding and overcoming group conflict* (pp. 302–333). New York, NY: Sage.

- Marshall, S. (2007) Identifying cognitive state from eye metrics. *Aviation, Space and Environmental Medicine*, 78(5) B165–175.
- Marshall, W. H., Talbot, S. A., & Ades, H. W. (1943). Cortical response of the anesthetized cat to gross photic and electric afferent stimulation. *J Neurophysiol*, 6, 1–15.
- Mass, R., Wolf, K., Wagner, M., & Haasen, C. (2000). Different sustained attention/vigilance changes over time in schizophrenics and controls during a degraded stimulus continuous performance test. *European Archives of Psychiatry and Clinical Neuroscience*, 250, 24–30.
- Masuda, T. & Nisbett, R. E. (2001). Attending holistically vs. analytically: Comparing the context sensitivity of Japanese and Americans. *Journal of Personality and Social Psychology*, 81, 922–934.
- Mathieu, J. E., Goodwin, G. F., Heffner, T. S., Salas, E., & Cannon-Bowers, J. A. (2000). The influence of shared mental models on team process and performance. *J Appl Psychol*, 85(2), 273–283.
- Matthews, G., Joyner, L., Gilliland, K., Campbell, S., Falconer, S., & Huggins, J. (1997). Validation of a comprehensive stress state questionnaire: Towards a state "Big Three"? In I. J. F. Mervielde, P. De Fruyt, & F. Ostendorf (Eds.), *Personality Psychology in Europe* (Vol. 7). Tilburg: Tilburg University Press.
- Matveev, A. V. & Nelson, P. E. (2004). Cross cultural communication competence and multicultural team performance. *International Journal of Cross Cultural Management*, 4, 253–270.
- Maynard, D. W. (1991). On the interactional and institutional bases of asymmetry in clinical discourse analysis. *American Journal of Sociology*, 92(2), 448–495.
- Mayne, R. (1974). A systems concept of the vestibular organs. In: Kornhuber HH (ed) *Handbook of Sensory Physiology*, vol VI/2. Springer Verlag, Berlin Heidelberg New York, pp 493-580.
- Mayer, R. E., & Moreno, R. (2003). Nine ways to reduce cognitive load in multimedia learning. *Educational Psychologist*, 38, 45–52
- McCandless, J. W., McCann, R. S., Berumen, K. W., Gauvain, S. S., Palmer, V. J., Stahl, W. D. & Hamilton, A. S. (2005). Evaluation of the Space Shuttle Cockpit Avionics Upgrade (CAU) displays. In *Proceedings of the 49th Annual Meeting of the Human Factors and Ergonomics Society*. Santa Monica, CA: Human Factors and Ergonomics Society.
- McCann, R., Beutter, B. R., Matessa, M., McCandless, M., J. W., Spirkovska, L., Liston, D., Hayashi, M., Ravinder, U., Elkins, S., Renema, F., Lawrence, R., Hamilton, A. (2006). Description and evaluation of a real-time fault management concept for next-generation space vehicles, Internal Report to Johnson Space Center, NASA Ames Research Center Moffett Field, CA.
- McCarthy, G.W. (1990). Spatial disorientation in the F-16. In *Aeromedical and Training Digest*. 4, 3.
- McClelland, J. L. & Rummelhart, D. E. (Eds.). (1986). *Parallel distributed processing. Explorations in the microstructure of cognition* (Vol. 2). Cambridge, MA: MIT Press/Bradford Books.
- McCluskey R, Clark J, Stepaniak P. Correlation of Space Shuttle landing performance with cardiovascular and neurological dysfunction resulting from space flight. NASA Bioastronautics Roadmap, 2001.
- McCracken, J., Aldrich, T. B., (1984) Analysis of selected LHX mission functions. Technical note ASI 479-024-84(b) Anacapa Sciences.
- McDonald, P. V., Basdogan, C., Bloomberg, J. J., Layne, C. S. (1996). Lower limb kinematics during treadmill walking after space flight: Implications for gaze stabilization. *Exp Brain Res*. 112: 325-334.
- McGrath, J. E. (1984). *Groups: Interaction and performance*. Englewood Cliffs, NJ: Prentice Hall.

- McKee, S. P., Silverman, G. H., & Nakayama, K. (1986). Precise velocity discrimination despite random variations in temporal frequency and contrast. *Vision Res*, 26(4), 609–19.
- McLellan, T. M., Kamimori, G. H., Bell, D. G., Smith, I. F., Johnson, D., & Belenky, G. (2005). Caffeine maintains vigilance and marksmanship in simulated urban operations with sleep deprivation. *Aviat Space Environ Med*, 76, 39–45.
- McLennan, J., Holgate, A. M, Omodei, M. M. and Wearing, A. J. (2005). Decision making effectiveness in wildfire incident management teams. *Proceedings of the Seventh International Naturalistic Decision Making Conference*, Amsterdam, The Netherlands.
- McNulty, P. J., Pease, V. P., & Bond, V. P. (1977). Comparison of the light-flash phenomena observed in space and in laboratory experiments. *Life Sci Space Res*, 15, 135–140.
- Means, B., Salas, E., Crandall, B., & Jacobs, T. O. (1993). Training decision makers for the real world. In J. O. G. Klein, J. Orasanu, E. Klien, R. Calderwood, & C. E. Zsombok (Eds.), *Decision making in action: models and methods* (pp. 51–99). Norwood, NJ: Ablex.
- Meck, J. V., Reyes, C. J., Perez, S. A., Goldberger, A. L., Ziegler, M. G. (2001). Marked exacerbation of orthostatic intolerance after long- vs. short-duration spaceflight in veteran astronauts. *Psychosom Med* 63: 865–873.
- Meck, J. V., Waters, W. W., Ziegler, M. G., deBlock, H. F., Mills, P. J., Robertson, D., Huang, P. L. (2004). Mechanisms of postspaceflight orthostatic hypotension: low alpha1-adrenergic receptor responses before flight and central autonomic dysregulation postflight. *Am. J. Physiol. Heart Circ. Physiol* 286: H1486–1495.
- Mehan, H. (1985). The structure of classroom discourse. In T. A. Van Dijk (Ed.), *Handbook of discourse analysis: Vol. 3. Discourse and dialogue* (Vol. 3, pp. 119-131). London, UK: Academic Press.
- Meichenbaum, D. (1996). Stress inoculation training for coping with stressors. *The Clinical Psychologist*, 47, 4–7.
- Meichenbaum, D. (2007). Stress inoculation training: A preventative and treatment approach. In P. M. Lehrer, R. L. Woolfolk & W. S. Sime (Eds.), *Principles and practice of stress management* (3rd ed.). New York, NY: Guilford Press.
- Merfeld, D. M., Park, S., Gianna-Poulinm C., Black, F. O., & Wood, S. (2005). Vestibular perception and action use qualitatively different mechanisms. I. Frequency response of VOR and perceptual responses during translation and tilt. *J Neurophysiol*, 94, 186–198.
- Merritt, A. C. & Helmreich, R. L. (1996). Human factors on the flight deck: The influence of national culture. *Journal of Cross-Cultural Psychology*, 27(1), 5-24.
- Metzger, U., & Parasuraman, R. (2001). The role of the air traffic controller in future air traffic management: An empirical study of active control versus passive monitoring. *Human Factors*, 43, 519–528.
- Meyer, J. (2004). Conceptual issues in the study of dynamic hazard warnings. *Human Factors*, 46, 196-204.
- Meyer, D. E. & Kieras, D. E. (1997a). A computational theory of executive cognitive processes and multiple-task performance: Part 1. Basic mechanisms. *Psychological Review*, 104, 3–65.

- Meyer, D. E. & Kieras, D. E. (1997b). A computational theory of executive cognitive processes and multiple-task performance: Part 2. Accounts of psychological refractory-period phenomena. *Psychological Review*, 104, 749–791.
- Mickelson, J. S. & Campbell, J. H. (1975). Information behavior: Groups with varying levels of interpersonal acquaintance. *Organizational Behavior and Human Decision Processes*, 13, 193–205, 20(4), 499-537.
- Miller, C. A., Peters, B. T., Brady, R. R., Richards, J. R., Ploutz-Snyder, R. J., Mulavara, A. P., Bloomberg, J. J. (2010). Changes in toe clearance during treadmill walking after long-duration spaceflight. *Aviation, Space and Environmental Medicine* 81(10): 919-28.
- Miller, C. S. & Laird, J. E. (1996). Accounting for graded performance within a discrete search framework. *Cognitive Science: A Multidisciplinary Journal of Cross-Cultural Psychology*, 27(1), 5–24.
- Miller, D. L. (2001). Reexamining teamwork KSAs and team performance. *Small Group Research*, 32(6), 745-767.
- Miller, G. A. (1956). The magical number seven, plus or minus two: Some limits on our capacity for processing information. *Psychological Review*, 63, 81-97.
- Miller, J. O., & Low, K. (2001). Motor processes in simple, go/no-go, and choice reaction time tests: A psychophysiological analysis. *J Exp Psychol*, 27, 266–289.
- Misiolek, N. I. (2005). Patterns of emergent leadership in ad hoc virtual teams (Dissertation Proposal). Syracuse University, Department of Information Sciences. (incomplete reference)
- Mitchell, D. K.; Samms, C., Henthorn, T., & Wojciechowski, J. (2003). Trade Study: A Two- Versus Three-Soldier Crew for the Mounted Combat System (MCS) and Other Future Combat System Platforms; ARL-TR-3026; U.S. Army Research Laboratory: Aberdeen Proving Ground, MD.
- Mohammed, S. & Angell, L. C. (2004). Surface- and deep-level diversity in workgroups: Examining the moderating effects of team orientation and team process on relationship conflict. *Journal of Organizational Behavior*, 25, 1015–1039.
- Monk, T. H., Buysse, D. J., Billy, B. D., Kennedy, K. S., & Willrich, L. M. (1998). Sleep and circadian rhythms in four orbiting astronauts. *Journal of Biological Rhythms*, 13(3), 188–201.
- Moore, S., Cohen, B., Raphan, T., et al. (2005). Spatial orientation of optokinetic nystagmus and ocular pursuit during orbital space flight. *Exp Brain Res*, 160, 38–59.
- Moore, B. C. J. (2004). *An introduction to the psychology of hearing*. San Diego, CA: Elsevier Academic Press.
- Moore, S. T., Clement, G., Dai, M., Raphan, T., Solomon, D. and Cohen, B. (2003). Ocular and perceptual responses to linear acceleration in 0g: Alterations in otolith function on the COSMOS and Neurolab flights. *J Vest Res*, 13, 377–393.
- Moore, A. D. Jr., Lee, S. M., Charles, J. B., Greenisen, M. C., Schneider, S. M. (2001). Maximal exercise as a countermeasure to orthostatic intolerance after spaceflight. *Med Sci Sports Exerc* 33: 75–80.
- Moore, A. D., Lee, S. M. C., Stenger, M. B., Platts, S. H. (2010). Cardiovascular exercise in the U.S. space program: Past, present and future. *Acta Astronautica* 66: 974–988.
- Moos, R. H. & Humphrey, B. (1974). *Group environment scale, form R*. Palo Alto, CA: Consulting Psychologists Press.

- Moray, N. and Rotenburg, I. (1989). Fault management in process control: eye movements and action. *Ergonomics*, 32 (11), 1319-1342.
- Moray, N. (1988). Mental workload since 1979. In D.J. Osborne (Ed.) *International Reviews of Ergonomics: Current Trends in Human Factors Research and Practices* (Vol. 2, pp. 38–64). London, UK: Taylor and Francis.
- Moray, N. (Ed.). (1979). *Human Mental Workload: Its Theory and Measurement*. New York, NY: Plenum Press.
- Morgan, B. B. & Lassiter, D. L. (1992). Team composition and staffing. In R. W. Swezey & E. Salas (Eds.), *Teams: Their training and performance* (pp. 75-100). Norwood, NJ: Ablex Publishing Corporation.
- Morgenthaler, G. W., Fester, D. A., & Cooley, C. G. (1994). An assessment of habitat pressure, oxygen fraction, and EVA suit design for space operations, *Acta Astronautica*, 32, 39–49.
- Morgeson, F. P., Matthew, H. R., & Michael, A. C. (2005). Selecting individuals in team settings: The importance of social skills, personality characteristics, and teamwork knowledge. *Personnel Psychology*, 58, 583-611.
- Moroney, N., Fairchild, M. D., Hunt, R. W. G., Li, C., Luo, M. R., & Newman, T. (2002). The CIECAM02 Color Appearance Model. In Proceedings from the IS&T/SID 10th Color Imaging Conference (pp.23-27). Scottsdale, UK.
- Mulavara, A. P., Cohen, H. S., Bloomberg, J. J. (2009). Critical features of training that facilitate adaptive generalization of over ground locomotion. *Gait and Posture* 29(2): 242-8.
- Mulavara, A. P., Feiveson, A., Feidler, J., Cohen, H. S., Peters, B.T., Miller, C. A., Brady, R., Bloomberg, J. J. (2010). Locomotor function after long-duration space flight: Effects and motor learning during recovery. *Exp Brain Res*. 202(3): 649-59.
- Mulder, G. & Mulder, L. (1981). Information processing and cardiovascular control. *Psychophysiology*, 18, 392–401.
- Mullen, B. & Baumeister, R. F. (1987). Group effects on self-attention and performance: Social loafing, social facilitation, and social impairment. In C. Hendrick (Ed.), *Review of personality and social psychology* (pp. 189-206). Newbury Park, CA: Sage.
- Mullen, B. & Copper, C. (1994). The relation between group cohesiveness and performance: An integration. *Psychological Bulletin*, 115(2), 210–227.
- Mullen, B., Johnson, D. A., & Drake, S. D. (1987). Organizational productivity as a function of group composition: A self-attention perspective. *Journal of Social Psychology*, 127, 143–150.
- NASA Human Research Program. (2008). HRP 47072 *Risk Evidence Book*. Houston, TX: National Aeronautics and Space Administration.
- NASA Human Research Program. (2007). *Integrated Research Plan*. Houston, TX: National Aeronautics and Space Administration.
- National Aeronautics and Space Administration. (2009). Human-rating requirements for space systems (w/change 1 dated 12/7/2009; NPR 8705.2B). NASA, Moffett Field, CA.
- National Research Council Space Studies Board. (1998). *A strategy for research in space biology and medicine in the new century*. Washington, DC: National Academy Press.

- NAS-NRC. (1980). Recommended standard procedures for the clinical measurement and specification of visual acuity: Report of Working Group 39. *Advances in Ophthalmology*, 41, 103–148.
- National Air Traffic Services. (1999). *Human Factors Guidelines Database*. Christchurch, UK: National Air Traffic Services, Human Factors Unit.
- Nemeth, C. J. & Mullen, K. T. (1985). The contrast sensitivity of human colour vision to red-green and blue-yellow chromatic gratings. *J Physiol*, 359, 381–400.
- Nemeth, C. J. & Owens, P. (1996). Making work groups more effective: The value of minority dissent. In M. A. West (Ed.), *Handbook of work group psychology* (pp. 125–142). Chichester, UK: John Wiley.
- Nemeth, C. J. (1986). Differential contributions of majority and minority influence. *Psychological Review*, 93, 23–32.
- Nemeth, C. J., & Staw, B. M. (1989). The tradeoffs of social control and innovation in groups and organizations. *Advances in Experimental Social Psychology*, 22, 175–206.
- Neubert, M. J. (1999). Too much of a good thing or the more the merrier? Exploring the dispersion and gender composition of informal leadership in manufacturing teams. *Small Group Research*, 30(5), 635–646.
- Newell, A. (1990). *Unified theories of cognition*. Cambridge, MA: Harvard University Press.
- Newman, D. J., Jackson, D. K., Bloomberg, J. J. (1997). Altered astronaut lower limb and mass center kinematics in downward jumping following space flight. *Exp Brain Res*. 117: 30-42.
- Nickel, P. & Nachreiner, F. (2003). Sensitivity and Diagnosticity of the 0.1-Hz Component of Heart Rate Variability as an Indicator of Mental Workload. *Human Factors*, 45(4), 575–590.
- Nicogossian, A. E., Sawin, C. F., & Huntoon, C. L. (1993). Overall Physiologic Response to Space Flight. In: A. E. Nicogossian, C. L. Huntoon, & S. L. Pool (Eds.). *Space Physiology and Medicine* (3rd ed., pp. 215). Philadelphia, PA: Lea & Febiger.
- Nisbett, R. E., Peng, K., Choi, I., & Norenzayan, A. (2001). Culture and systems of thought: Holistic versus analytic cognition. *Psychological Review*, 108(2), 291–310.
- Norenzayan, A., Smith, E. E., Kim, B. J., & Nisbett, R. E. (2002). Cultural preferences for formal versus intuitive reasoning. *Cognitive Science*, 26, 653–684.
- North, R. & Riley, V. (1988). W/Index: A predictive model of operator workload. In *Applications of Human Performance Models to Systems Design*. New York, NY: Plenum Press.
- NTSB. (1994). *A review of flightcrew-involved, major accidents of U.S. Air Carriers, 1978-1990* (NTSB report No. PB 94-917001, NTSB/SS-94/01). Washington, DC: NTSB.
- Nullmeyer, R., Stella, D., Montijo, G. A., & Harden, S. W. (2005). Human factors in Air Force flight mishaps: Implications for change. *Proceedings of the Interservice/Industry Training, Simulation, and Education Conference*, Paper No. 2260, 1-11. Orlando FL.
- Nygren, T. E. (1991). Psychometric properties of subjective workload measurement techniques: Implications for their use in the assessment of perceived workload. *Human Factors*, 33, 17–33.
- Oberg, J. E. (1981). *Red Star in orbit*. New York, NY: Random House.
- Oberg, J. E., & Oberg, A. R. (1986). *Pioneering space*. New York, NY: McGraw-Hill.
- O'Briant, C. R. & Ohlbaum, M. K. (1970). Visual acuity decrements associated with whole body plus or minus Gz vibration stress. *Aerospace medicine*, 41(1), 79–82.

- O'Brien, G. (1968). *Methods of analyzing group tasks* (Technical Report No. 46, No. DTIC AD 647 762). Urbana, IL: Dept. of Psychology, Group Effectiveness Research Laboratory.
- O'Donnell, R. D. & Eggemeier, F. T. (1986). Workload assessment methodology. In K. Bott, L. Kaufman, & J. Thomas (Eds.), *Handbook of Perception and Human Performance*, (Vol. 2, pp. 42–49). New York, NY: John Wiley & Sons.
- O'Hanlon, J. & Griffin, M. (1971). Some effects of the vibration of reading material upon visual performance. Technical Report No. 49, Institute of Science and Vibration Research. University of Southampton. UK.
- O'Hare, D. (1990). Pilots' perception of risks and hazards in general aviation. *Aviat Space Environ Med*, 61(7), 599603.
- Ohbuchi, K. I. & Takahashi, Y. (1994). Cultural styles of conflict management in Japanese and Americans: Passivity, covertness, and effectiveness of strategies. *Journal of Applied Social Psychology*, 24(15), 1345–1366.
- Ohlsson, J. & Villarreal, G. (2005). Normal visual acuity in 17-18 year olds. *Acta Ophthalmologica Scandinavica*, 83(4), 487–491, <http://www.blackwell-synergy.com/doi/abs/10.1111/j.1600-0420.2005.00516.x>
- Oliver, L. W., Harman, J., Hoover, E., Hayes, S. M., & Pandhi, N. A. (2000). A quantitative integration of the military cohesion literature. *Military Psychology*, 11(1), 57–83.
- Olzak, L. A. & Thomas, J. P. (1986). Seeing spatial patterns. In K. R. Boff, L. Kaufman & J. P. Thomas (Eds.), *Handbook of perception and human performance* (Vol. 1, pp. 7.1–7.56). New York, NY: Wiley.
- O'Neal, M. R., Task, H. L., & Genco, L. V. (1992). Effect of 0g on several visual functions during STS shuttle missions: NASA, <http://hdl.handle.net/2060/19920013088>.
- Orasanu, J. (1994). Shared problem models and flight crew performance. In N. Johnston, N. McDonald & R. Fuller (Eds.), *Aviation psychology in practice* (pp. 255–285). Aldershot, UK: Ashgate.
- Orasanu, J. (1995a). Evaluating team situation awareness through communication. In D. Garland & M. Endsley (Eds.), *Proceedings of International Conference on Experimental Analysis and Measurement of Situation Awareness*. Daytona Beach, FL: Embry-Riddle Aeronautical University Press.
- Orasanu, J. (1995): Training for Aviation Decision Making: The Naturalistic Decision-Making Perspective. In: *Proceedings of the Human Factors and Ergonomics Society 39th Annual Meeting*. (pp. 1258-1262). San Diego, CA.
- Orasanu, J. (1997). Stress and naturalistic decision making: Strengthening the weak links. In R. Flin, E. Salas, M. Strub, & L. Martin (Eds.), *Decision making under stress; Emerging themes and applications* (pp. 49–160). Aldershot, UK: Ashgate.
- Orasanu, J. M. & Backer, P. (1996). Stress and Military Performance. In J. E. Driskell & E. Salas (Eds.) *Stress and Human Performance* (pp. 89–125) Mahwah, NJ: Lawrence Erlbaum Associates.
- Orasanu, J. & Fischer, U. (1992). Distributed cognition in the cockpit: Linguistic control of shared problem solving, *Proceedings of the Fourteenth Annual Conference of the Cognitive Science Society* (pp. 189–194). Hillsdale, NJ: Erlbaum.
- Orasanu, J. & Fischer, U. (1997). Finding decisions in natural environments: The view from the cockpit. In C. Zsombok & G. A. Klein (Eds.), *Naturalistic Decision Making* (pp. 343–357). Mahwah, NJ: Lawrence Erlbaum Associates.

- Orasanu, J. & Fischer, U. (2008). Improving healthcare communication: Lessons from the flightdeck. In C. Nemeth (Ed.), *Improving healthcare team communication: Building on lessons from aviation and aerospace*. Aldershot, UK: Ashgate.
- Orasanu, J., Fischer, U., & Davison, J. (2004). Risk perception and risk management in aviation. In R. Dietrich & K. Jochum (Eds.), *Teaming up: Components of safety under high risk* (pp. 93–116). Burlington, VT: Ashgate.
- Orasanu, J., Fischer, U., & Davison, J. (2004). Pilots' risk perception and risk management: Their role in plan continuation errors. Moffett Field CA.
- Orasanu, J., Fischer, U., Parke, B., McDonnell, L., Kraft, N., & Anderson, B. (2008). *Alternative techniques for monitoring and evaluating team cohesion*. Moffett Field, CA: NASA Ames Research Center: NASA Behavioral Health and Performance (BHP) Element of the Human Research Program.
- Orasanu, J., Fischer, U., Tada, Y., & Kraft, N. (2004). Team stress and performance: Implications for long-duration space missions, 48th Annual Meeting of the Human Factors and Ergonomics Society. (pp. 552-556). New Orleans, LA.
- Orasanu, J., Kraft, N., McDonnell, L., Parke, B., Tada, Y., Fischer, U., et al. (2008). *Team training strategies to enhance cohesion and team performance* (Draft Milestone Report, NASA Behavioral Health and Performance (BHP) Element of the Human Research Program). Moffett Field, CA: NASA Ames Research Center.
- Orasanu, J., Martin, L., & Davison, J. (2002). Cognitive and contextual factors in aviation accidents: Decision errors. In E. Salas & G. Klein (eds.), *Linking expertise and naturalistic decision making* (pp. 209-226). Mahwah: Erlbaum Associates.
- Orasanu, J. & Strauch, B. (1994). Temporal factors in aviation decision making, *Proceedings of the Human Factors and Ergonomics Society 38th Annual Meeting* (Vol. 2, pp. 935–939). Santa Monica, CA: Human Factors and Ergonomics Society.
- Orasanu, J., Kraft, N., McDonnell, L., et al. (2008). Team training strategies to enhance cohesion and team performance. Moffett Field, CA: NASA Ames Research Center: NASA Behavioral Health and Performance (BHP) Element of the Human Research Program. (incomplete reference).
- Orasanu, J., Martin, L., & Davison, J. (2002). Cognitive and contextual factors in aviation accidents: Decision errors. In E. Salas & G. Klein (Eds.), *Linking expertise and naturalistic decision making* (pp. 209-226). Mahwah, NJ: Erlbaum.
- Orasanu, J., Wich, M., Fischer, U., et al. (1993). Distributed problem solving by pilots and dispatchers. International Symposium on Aviation Psychology, 7th, (pp. 198-203). Columbus, OH.
- Owsley, C., Sekuler, R., & Siemsen, D. (1983). Contrast sensitivity throughout adulthood. *Vision Res*, 23(7), 689–699,
http://www.ncbi.nlm.nih.gov/entrez/query.fcgi?cmd=Retrieve&db=PubMed&dopt=Citation&list_uids=6613011
- Paas, F., Renkl, A., & Sweller, J. (2003). Cognitive Load theory and instructional design: recent developments. *Educational Psychologist*, 31, 1–5.
- Paige, G. & Tomko, D. (1991). Eye movement responses to linear head motion in the squirrel monkey. I. Basic characteristics. *J Neurophysiol*, 65, 1170–1182.
- Paige, G. D. & Seidman, S. H. (1999). Characteristics of the VOR in response to linear acceleration. *Ann NY Acad Sci*, 871, 123–135.

- Paige, G. D., Telford, L., Seidman, S. H., & Barnes, G. R. (1998). Human vestibuloocular reflex and its interactions with vision and fixation distance during linear and angular head movement. *J Neurophysiol*, 80, 2391–2404.
- Paletz, S. B. F. (2006). Types, causes, and countermeasures of team conflict. Panel presentation at the Annual Conference of the American Psychological Association, New Orleans, LA.
- Paletz, S. B. F. (under review). Individual selection and crew assembly: A gap analysis for exploration missions. In S. B. F. Paletz & M. K. Kaiser (Eds.), *Behavioral Health and Performance Gap Analysis White Papers*. Moffett Field, CA: NASA. (incomplete reference).
- Paletz, S. B. F., Bearman, C. R., Orasanu, J., & Holbrook, J. (under review). Changing latent vulnerabilities into pressures: Including social psychology in HFACS. (incomplete reference).
- Paloski, W.H & Oman C.M. (2008) Summary of Evidence Supporting HRP/HHC Risk of Impaired Ability to Maintain Control of Vehicles and Other Complex Systems. Sensory-Motor Discipline Integrated Product Team Report, 2008. (incomplete reference)
- Paloski, W. H., Oman, C. M., Bloomberg, J. J., Reschke, M. F., Wood, S. J., Harm, D. L., Peters, B. T., Mulavara, A. P., Locke, J. P., Stone, L. S. (2008). Risk of sensory-motor performance failures during exploration-class space missions: A review of the evidence and recommendations for future research. *J Gravit Physiol* 15: 1-29.
- Paloski, W. H. & Reschke, M. F. (1999). Section 5.4. Recovery of postural equilibrium control following space flight. In: C. F. Sawin, G. R. Taylor, & W. L. Smith (Eds.) *Extended Duration Orbiter Medical Project 1989–1995* (NASA SP-1999-534). Washington, DC: National Aeronautics and Space Administration.
- Paloski, W. H. (1998). Vestibulospinal adaptation to 0g. *Otolaryngol Head Neck Surg*. 118(3 Pt 2); S39–44.
- Paloski, W. H., Bloomberg, J. J., Reschke, M. F., Harm, D. L. (1994). Space flight induced changes in posture and locomotion. *Journal of Biomechanics* 27: 812.
- Paloski, W. H., Black, F. O., Reschke, M. F., Calkins, D. S., Shupert, C. (1993). Vestibular ataxia following shuttle flights: effects of microgravity on otolith-mediated sensorimotor control of posture. *Am J Otol*. 14: 9-17.
- Paloski, W. H., Reschke, M. F., Black, F. O., Doxey, D. D., Harm, D. L. (1992). Recovery of postural equilibrium control following spaceflight. *Ann N Y Acad Sci* 656: 747-754.
- Panayiotou, G. & Vrana, S. R. (2004). The role of self-focus, task difficulty, task self-relevance, and evaluation anxiety on reaction time performance. *Motivation and Emotion*, 28, 171–196.
- Pantle, A. & Sekuler, R. (1969). Contrast response of human visual mechanism sensitive to orientation and direction of motion. *Vision Res*, 9(3), 397–406.
- Parasuraman, R., Mouloua, M., & Molloy, R. (1996). Effects of adaptive task allocation on monitoring of automated systems. *Human Factors*, 38, 665–679.
- Parke, B. (1985). A field adaptation of the SYMLOG adjective rating form suitable for populations including children. *International Journal of Small Group Research*, 1(1), 89–95.
- Parke, B. & Houben, H. C. (1985). An objective analysis of group types. *International Journal of Small Group Research*, 13, 131–149.

- Parke, B., Kanki, B., Nord, K., & Bianchi, A. (2000). Crew climate and performance: Use of group diagrams based on behavioral ratings, 44th IEA2000/HFES 2000 Congress (pp. 3149-3152). San Diego, CA.
- Parker, D. E., Reschke, M. F., Arrott, A. P., Homick, J. L., & Lichtenberg, B. K. (1985). Otolith tilt-translation reinterpretation following prolonged weightlessness: implications for preflight training. *Aviat Space Environ Med*, 56, 601–606.
- Parker, D. E., Reschke, M. F., Ouyang, L., et al. (1986). Vestibulo-ocular reflex changes following weightlessness and preflight adaptation training, In E. Keller, & D. Zee (Eds) *Adaptive Processes in Visual and Oculomotor Systems* (pp 103–108). Oxford, UK: Pergamon Press.
- Parker, J. & West, V. (1973). *Bioastronautics Data Book*, NASA SP-3006 (Second ed.): NASA, Washington, D. C.
- Parks, D. L. & Boucek Jr., G. P. (1989) In G. McMillan, D. Beevis, E. Salas, M.H. Strub, R. Sutton, & L. Van Breda (Eds.), *Applications of Human Performance Models to System Design* (pp. 259–273), New York, NY: Plenum Press.
- Pashler, H. (1988). Familiarity and visual change detection. *Perception & Psychophysics*, 44, 369–378.
- Paul, C. & Gross, A. (1981). Increasing productivity and morale in a municipality: Effects of organization development. *Journal of Applied Behavioral Science*, 17, 59–78.
- Pavy-Le Traon, A., Heer, M., Narici, M. V., et al. (2007). From space to Earth: advances in human physiology from 20 years of bed rest studies (1986-2006). *Eur J Appl Physiol*, 101(2), 143–194.
- Payne, J. W., Bettman, J. R., & Johnson, E. J. (1988). Adaptive strategy selection in decision making. *Journal of Experimental Psychology: Learning, Memory, and Cognition*, 14(3), 534–552.
- Pearce, C. L. & Sims Jr., H. P. (2002). Vertical versus shared leadership as predictors of the effectiveness of change management teams: An examination of aversive, directive, transactional, transformational, and empowering leader behaviors. *Group Dynamics: Theory, Research and Practice*, 6(2), 172-197.
- Peck, V. A. & John, B. E. (1992). Browser-Soar: a computational model of a highly interactive task. Proceedings of the SIGCHI Conference on Human Factors in Computing Systems: Monterey, CA, USA, 165-172.
- Pelli, D. G., Cavanagh, P., Desimone, R., et al. (2007). Crowding: Including illusory conjunctions, surround suppression, and attention. *Journal of Vision*, 7(2), 1–1, <http://journalofvision.org/7/2/i/>.
- Peng, K. & Nisbett, R. E. (1999). Culture, dialectics and reasoning about contradictions. *American Psychologist*, 54(9), 741–754.
- Peng, X., Stone, L. S., & Li, L. (2008). Humans can control heading independent of visual path information. *Journal of Vision*, 8(6), 1160a.
- Pentland, A., Curhan, J., Khilnani, R., et al. (2004). Social dynamics: Signals Toward a Negotiation Advisor, from <http://hd.media.mit.edu>.
- Pentland, A. (2008). *Honest signals: How they shape our world*. Cambridge, MA: MIT Press.
- Perez, S. A., Charles, J. B., Fortner, G. W., Hurst, V. 4th, Meck, J. V. (2003). Cardiovascular effects of anti-G suit and cooling garment during space shuttle re-entry and landing. *Aviat Space Environ Med* 74: 753–757.

- Perhonen, M. A., Franco, F., Lane, L. D., Buckley, J. C., Blomqvist, C. G., Zerwekh, J. E., Peshock, R. M., Weatherall, P. T., Levine, B. D. (2001). Cardiac atrophy after bed rest and spaceflight. *J. Appl. Physiol.* 91: 645–653.
- Perrow, C. (1984). *Normal accidents: Living with high-risk technologies*. New York, NY: Basic Books.
- Persterer, A., Opitz, M., Koppensteiner, C., et al. (1993). AUDIMIR: Directional hearing at 0g. *Journal of the Audio Engineering Society*, 41, 239–247.
- Peters, B. T., Miller, C. A., Richards, J. T., Brady, R. A., Mulavara, A. P., Bloomberg, J. J. (2011). Dynamic visual acuity during walking after long-duration spaceflight. *Aviation, Space and Environmental Medicine* 82(4): 463-6.
- Peterson, M. S., Kramer, A. F., & Irwin, D. E. (2004). Covert shifts of attention precede involuntary eye movements. *Perception & Psychophysics*, 66, 398–405.
- Pew, R. W. & Mavor, A. S. (Eds.). (1998). *Modeling human and organizational behavior: Application to military simulations*. Washington, DC: National Academies Press.
- Pew, R. W., Gluck, K. A., & Deutsch, S. (2005). Accomplishments, challenges, and future directions for human behavior representation. In K. A. Gluck, & R. W. Pew (Eds.), *Modeling human behavior with integrated cognitive architectures: Comparison, evaluation, and validation*, (pp. 397–414). Mahwah, NJ: Lawrence Erlbaum Associates.
- Philips, G. C. & Wilson, H. R. (1984). Orientation bandwidths of spatial mechanisms measured by masking. *J Opt Soc Am A*, 1, 226–232.
- Phipps, S. & Mulhern, R. K. (1995). Family cohesion and expressiveness promote resilience to the stress of pediatric bone marrow transplant: A preliminary report. *Developmental and Behavioral Pediatrics*, 16(4), 257–263.
- Pilcher, J. J. & Huffcutt, A. I. (1996). Effects of sleep deprivation on performance: A meta-analysis. *Sleep*, 19(4), 318–326.
- Pilcher, J. J., McClelland, L. E., Moore, D. W., et al. (2007). Language performance under sustained work and sleep deprivation conditions. *Aviat Space Environ Med*, 78(5, Section II), B25–B38.
- Platts, S. H., Martin, D. S., Stenger, M. B., Perez, S. A., Ribeiro, L. C., Summers, R., Meck, J. V. (2009). Cardiovascular adaptations to long-duration head-down bed rest. *Aviat Space Environ Med* 80: A29–36.23.
- Platts, S. H., Tuxhorn, J. A., Ribeiro, L. C., Stenger, M. B., Lee, S. M. C., Meck, J. V. (2009). Compression garments as countermeasures to orthostatic intolerance. *Aviat Space Environ Med* 80: 437–442.
- Poirson, A. B. & Wandell, B. A. (1993). The appearance of colored patterns: pattern-color separability. *J Opt Soc Am A*, 10(12), 2458–2470.
- Polk, T. A. & Newell, A. (1995). Deduction as verbal reasoning. *Psychological Review*, 102(3), 533–566.
- Pollack, I. (1952). The information of elementary auditory displays. *The Journal of the Acoustical Society of America*, 24, 745–749.
- Posner, M. I. (1980). Orienting of attention. *The Quarterly Journal of Experimental Psychology*, 32, 3–25.

- Poulton, B. C., & West, M. A. (1999). The determinants of effectiveness in primary health care teams. *Journal of Interprofessional Care*, 12(1), 7-18.
- Powell, D. H., Kaplan, E. F., Whitla, D., Weintraub, S., Catlin, R., Funkenstein, H. H. (1996). *Microcog: Assessment of Cognitive Functioning* (Version 2.4). San Antonio, TX: The Psychological Corporation.
- Powell, M. R., Horrigan, Jr. D. J., Waligora, J. M., & Norfleet, W.T. (1993) Extravehicular Activities. In: A. E. Nicogossia, C. L. Huntoon, & S. L. Pool (Eds.). *Space Physiology and Medicine*, (3rd ed., pp. 128–140). Philadelphia, PA: Lea & Febiger.
- Prinzel, L. J. (2003) *Three experiments examining the use of electroencephalogram, event-related potentials, and heart-rate variability* (NASA/TP-2003-212442). Washington, DC: National Aeronautics and Space Administration.
- Pritchett, A. R. (2001). Reviewing the role of cockpit alerting systems. *Human Factors and Aerospace Safety*, 1, 5–39.
- Putnam, J. (2005). Human factors and the new vision for space exploration. *The Space Review*, Article 515/1. (Retrieved June 3, 2008, from <http://www.thespacereview.com/article/515/1>).
- Rabin, B. M., Joseph, J. A., & Shukitt-Hale, B. (2005). Effects of age and diet on the heavy particle-induced disruption of operant responding produced by a ground-based model for exposure to cosmic rays. *Brain Research*, 1036(1-2), 122-129.
- Rabin, J. (1994). Luminance effects on visual acuity and small letter contrast sensitivity. *Optometry and Vision Science*, 71, 685–688.
- Raby, M., & Wickens, C. D. (1994). Strategic workload management and decision biases in aviation. *International Journal of Aviation Psychology*, 4(3), 211–240.
- Radio Technical Commission for Aeronautics (RTCA). (1995). Report of the RTCA board of directors' select committee on free flight. Washington, DC.
- Ramachandran, R., & Lisberger, S. G. (2005). Normal performance and expression of learning in the vestibulo-ocular reflex (VOR) at high frequencies. *J Neurophysiol*, 93, 2028–2038.
- Rapisarda, B. A. (2002). The impact of emotional intelligence on work team cohesiveness and performance. *The International Journal of Organizational Analysis*, 10(4), 363–379.
- Rasker, P. (2002). Communication and performance in teams. Wageningen: Ponsen & Looijen.
- Rasmussen, J. (1985). The role of hierarchical knowledge representation in decision making and system management. *IEEE Transactions on Systems, Man and Cybernetics*, 2(SMC-15), 234–243.
- Rasmussen, J., Pejtersen, A. J., & Goodstein, L. P. (1994). *Cognitive Systems Engineering*. New York, NY: John Wiley & Sons, Inc.
- Rasmussen, T. H. & Jeppesen, H. J. (2006). Teamwork and associated psychological factors: A review. *Work and Stress*, 20(2), 105–128.
- Rea, M. S. (Ed.). (2000). *IESNA Lighting Handbook: reference and application*. (9 Ed.): New York, NY. Illuminating Engineering Society of North America.
- Reason, J. (1997). *Managing the risks of organizational accidents*. Aldershot, UK: Ashgate.
- Regan, D., & Hamstra, S. J. (1993). Dissociation of discrimination thresholds for time to contact and for rate of angular expansion. *Vision Res*, 33(4), 447–62

- Reid, G. B., Potter, S. S., Bressler, J. R. (1989). Subjective workload assessment technique (SWAT): a user's guide, No. AAMRL-TR-89-023, Armstrong Aerospace Medical Research Laboratory, Wright-Patterson Air Force Base, OH.
- Reid, G. B. (1985). Current status of the development of the subjective workload assessment technique. *Proceedings of the Human Factors Society 29th Annual Meeting* (pp. 220–223). Santa Monica, CA: Human Factors Society.
- Reid, G. B. & Colle, H. A. (1988) Critical SWAT values for predicting operator overload. *Proceedings of the Human Factors Society 32nd Annual Meeting* (pp. 1414–1418). Santa Monica, CA: Human Factors Society.
- Rensink, R. A., O'Regan, J. K., & Clark, J. J. (1997). To see or not to see: The need for attention to perceive changes in scene. *Psychological Science*, 8, 368–373.
- Reschke, M. F. & Parker, D. E. (1987). Effects of prolonged weightlessness on self-motion perception and eye movements evoked by roll and pitch. *Aviat Space Environ Med*, 58(9), A153-A157.
- Reschke, M. F., Harm, D. L., Parker, D. E., et al. (1991). DSO 459: Otolith tilt-translation reinterpretation. In: *Results of the Life Sciences DSOs Conducted Aboard the Space Shuttle, 1988–1990* (pp 33-50). Houston, TX: National Aeronautics and Space Administration.
- Reschke, M. F., Bloomberg, J. J., Harm, D. L., Krnavek, J. M., & Paloski, W.H. (1999) Section 5.3 Visual-vestibular integration as a function of adaptation to space flight and return to earth. In: C.F. Sawin, G.R. Taylor, & W.L. Smith (Eds.) *Extended Duration Orbiter Medical Project 1989–1995* (NASA SP-1999-534). Washington, DC: National Aeronautics and Space Administration.
- Reschke, M. F., Harm, D. L., Bloomberg, J. J., & Paloski, W. H. (1996). Chapter 7: Neurosensory and sensory-motor function. In A.M. Genin & C.L. Huntoon (Eds.) *Space Biology and Medicine, Vol. 3: Humans in Spaceflight, Book 1: Effects of 0g*. Washington, DC: American Institute of Aeronautics and Astronautics.
- Resnick, L. B., Salmon, M., Zeith, C. M., Wathen, S. H., & Holowchak, M. (1993). Reasoning in conversation. *Cognition and Instruction*, 11(3&4), 347–364.
- Reyna, V. F. & Brainerd, C. J. (1995). Fuzzy trace theory: an interim synthesis. *Learning and Individual Differences*, 7, 1-75.
- Rhatigan, J. L., Robinson, J. A., & Sawin, C. F. (2005). *Exploration-Related Research on ISS: Connecting Science Results to Future Missions*. Washington DC: National Aeronautics and Space Administration.
- Richard, C. M., Wright, R. D., Ee, C., Prime, S. L., Shimizu, Y., & Vavrik, J. (2002). Effect of a concurrent auditory task on visual search performance in a driving-related image-flicker task. *Human Factors: The Journal of Human Factors and Ergonomics Society*, 44, 108–119.
- Rieman, J. (1996). A field study of exploratory learning strategies. *ACM Transactions on Computer-Human Interaction (TOCHI)*, 3, 189–218.
- Ritscher, J. B. (2005). Cultural factors and the International Space Station. *Aviat Space Environ Med*, 76(6), B135–144.
- Ritsher, J. B., Kanas, N., Gushin, V. I., & Saylor, S. (2007). Cultural differences in patterns of mood states on board the International Space Station. *Acta Astronautica*, 61, 668–671.
- Ritter, F. E. & Larkin, J. H. (1994). Developing process models as summaries of HCI action sequences. *Human-Computer Interaction*, 9, 345–383.

- Robertson, M. M. & Endsley, M. R. (1995). A methodology for analyzing team situation awareness in aviation maintenance. In D. J. Garland & M. R. Endsley (Eds.), *Experimental analysis and measurement of situation awareness*. Daytona Beach, FL: Embry-Riddle University.
- Robinson, E. S. (1934). Work of the integrated organism. In C. Murchison (Ed.), *Handbook of General Experimental Psychology*. Worcester, MA: Clark University Press.
- Robson, J. G. (1966). Spatial and temporal contrast sensitivity functions of the visual system. *J Opt Soc Am*, 56, 1141–1142.
- Robson, J. G. & Graham, N. (1981). Probability summation and regional variation in contrast sensitivity across the visual field. *Vision Res*, 21(3), 409–418.
- Rogers, L. E. & Farace, R. V. (1975). Analysis of relational communication in dyads: New measurement procedures. *Human Communication Research*, 1, 222–239.
- Rohaly, A. M., & Owsley, C. (1993). Modeling the contrast-sensitivity functions of older adults. *J Opt Soc Am A*, 10(7), 1591–1599.
http://www.ncbi.nlm.nih.gov/entrez/query.fcgi?cmd=Retrieve&db=PubMed&dopt=Citation&list_uids=8350148.
- Rolfe, J. M. (1976). The measurements of human response in the man vehicle control situations. In T.B Sheridan & G. Johannsen (Eds.), *Monitoring Behavior and Supervisory Control*, New York, NY: Plenum Press.
- Roscoe, A H. (Ed.). (1987). Inflight assessment of workload using pilot ratings and heart rate. In *The Practical Assessment of Pilot Workload (AGARD-AG-282)*, (pp 78–82). Neuilly-sur-Seine, France: Advisory Group for Aerospace Research and Development.
- Roscoe, A. H., Ellis, G. A. (1990). A subjective rating scale for assessing pilot workload in flight: a decade of practical use, No. Technical Report TR 90019, Royal Aerospace Establishment, Farnborough, UK.
- Rosnet, E., Jurian, S., Cazes, G., & Bachelard, C. (2004). Mixed-gender groups: Coping strategies and factors of psychological adaptation in a polar environment. *Aviat Space Environ Med*, 75, C10–C13.
- Roth, E. R. (1967). Selection of space-cabin atmospheres. *Space Science Reviews*, 6, 452–492.
- Roufs, J. A. J. (1972). Dynamic properties of vision-I. Experimental relationships between flicker and flash thresholds. *Vision Res*, 12, 261–278.
- Rouse, W. B. & Morris, M. W. (1986). On looking into the black box: Prospects and limits in the search of mental models. *Psychological Bulletin*, 100, 359–363.
- Rovamo, J., Virsu, V., & Nasanen, R. (1978). Cortical magnification factor predicts the photopic contrast sensitivity of peripheral vision. *Nature*, 271, 54–56.
- Rubenstein, T. & Mason, A. F. (1979). The accident that shouldn't have happened: An analysis of Three Mile Island. *IEEE Spectrum*, 33-57.
- Rubin, G. S., West, S. K., Munoz, B., et al. (1997). A comprehensive assessment of visual impairment in a population of older Americans. The SEE Study. Salisbury Eye Evaluation Project. *Invest Ophthalmol Vis Sci*, 38(3), 557–568.
http://www.ncbi.nlm.nih.gov/entrez/query.fcgi?cmd=Retrieve&db=PubMed&dopt=Citation&list_uids=9071208.

- Rubio, S., Diaz, E., Martin, J., Puente, J. M. (2004). Evaluation of Subjective Mental Workload: A comparison of SWAT, NASA-TLX, and Workload Profile, *Applied Psychology: an International Review*, 53(1), 61-86.
- Rupert, A.H. (1999). An instrumentation solution for reducing spatial disorientation mishaps, *IEEE Engineering in Medicine and Biology*, 19, 71–80.
- Rupert, A. H., Guedry, F. E., & Reschke, M. F. (1994). The use of a tactile interface to convey position and motion perceptions. *Virtual Interfaces: Research and Applications, NATO Advisory Group for Aerospace Research and Development (AGARD) C P 541*. 20, 1–7.
- Russo, J. E. (1977). The value of unit price information. *Journal of Marketing Research*, 14(2), 193–201.
- Rywick, T. (1987). SYMLOG rating form reliability. *International Journal of Small Group Research*, 3(1), 119–125.
- Sahakian, B. J. & Owen, A. M. (1992). Computerized assessment in neuropsychiatry using CANTAB: discussion paper. *Journal of the Royal Society of Medicine*, 85(7), 399–402.
- Salamon, S. (1977). Family bonds and friendship bonds: Japan and West Germany. *Journal of Marriage and the Family*, 39, 807–820.
- Salas, E., Burke, C. S., Wilson-Donnelly, K. A., & Fowlkes, J. E. (2004). Promoting effective leadership within multicultural teams: An event-based approach. In D. V. Day, S. J. Zaccaro & S. M. Halpin (Eds.), *Leader development for transforming organizations: Growing leaders for tomorrow* (pp. 293–323). Mahwah, NJ: Lawrence Erlbaum Associates.
- Salas, E., Dickinson, T. L., Converse, S. A., & Tannenbaum, S. L. (1992). Toward an understanding of team performance and training. In R. W. Swezey & E. Salas (Eds.), *Teams: Their training and performance* (pp. 3–30). Norwood, NJ: Ablex.
- Salas, E., Nichols, D. R., & Driskell, J. E. (2007). Testing three team training strategies in intact teams: a meta-analysis. *Small Group Research*, 38, 471–488.
- Sarno, K. J., & Wickens, C. D. (1995). Role of multiple resources in predicting time-sharing efficiency: Evaluation of three workload models in a multiple-task setting: *International Journal of Aviation Psychology*. 5(1) 1995, 107-130.
- Sandal, G., Salas, E., Wilson, K. A., Priest, H. A., & Guthrie, J. W. (2006). Design, delivery, and evaluation of training systems. In G. Salvendy (Ed.), *Handbook of human factors and ergonomics*, (3rd ed., pp. 472–512). Hoboken, NJ: John Wiley.
- Sandal, G. M. (2004). Culture and tension during an International Space Station simulation: Result from SFINCSS'99. *Aviat Space Environ Med*, 75(7), C44–51.
- Sandal, G. M., Musson, D., Helmreich, R. L., & Gravdal, L. (2004). Social desirability bias in personality testing: Implications for astronaut selection. Paper presented at the *55th International Astronautical Congress*, pp. 634-641. Vancouver, Canada.
- Sandal, G. M., Vaernes, R., & Ursin, H. (1995). Interpersonal relations during simulated space missions. *Aviat Space Environ Med*, 66(7), 617–624.
- Sanders, A. F. (1998). *Elements of human performance: Reaction processes and attention in human skill*. Hillsdale, NJ: Lawrence Erlbaum Associates.
- Sandi, C. & Pinelo-Nava, M. T. (2007). Stress and memory: Behavioral effects and neurobiological mechanisms. *Neural Plasticity*, Article ID 78970.

- Santy, P. A. (1993). Multicultural factors in the space environment: Results of an international shuttle crew debrief. *Aviat Space Environ Med*, 196–200.
- Santy, P. A., Holland, A. W., Looper, L., & Marcondes-North, R. (1992). Results of an International Space Crew Debrief. Paper presented at the 63rd Annual Scientific Meeting of the Aerospace Medical Association. May 10-14., Miami, Florida.
- Sarter, N. B. and Woods, D. D. (1997). Team play with a powerful and independent agent: A corpus of operational experiences and automation surprises on the Airbus A-320. *Human Factors*, 39, 553—569.
- Sarter, N. B., Mumaw, R., & Wickens, C. D. (2007) Pilots' monitoring strategies and performance on highly automated flight decks: an empirical study combining behavioral and eye-tracking data. *Human Factors*. 49 (3), 347-357.
- Sarter, N. B., Woods, D. D., and Billings, C. E. (1997). Automation Surprises. In G. Salvendy (Ed.), *Handbook of Human Factors and Ergonomics* (2nd ed.) (pp. 1926-1943). New York, NY: Wiley.
- Sawin, C., Taylor, G. L. & Smith, W. L. (Eds.). (1999). Extended Duration Orbiter Medical Project 1989–1995 NASA SP-1999-534). Washington, DC: National Aeronautics and Space Administration.
- Schaefer, E. S. (1971). Development of hierarchical configurational models for parent behavior and child behavior. In J. E. Hill (Ed.), *Minnesota Symposia on Child Psychology*, 5, 1301-1316. University of Minnesota Press, Minnesota.
- Schaefer, E. S., Droppleman, L. F., & Kalverboer, A. F. (1965). *Development of a classroom behavior checklist and factor analyses of children's school behavior in the United States and the Netherlands*. Bethesda, MD: National Institute of Mental Health.
- Schafer, L. E. and Bagian, J. P. (1993). Overhead and forward reach capability during exposure to +1 and +6 Gx loads. *Aviat Space Environ Med*, 64, 979–984.
- Schippers, M. C., Den Hartog, D. N., Koopman, P. L., & Wienk, J. A. (2003). Diversity and team outcomes: The moderating effects of outcome interdependence and group longevity and the mediating effect of reflexivity. *Journal of Organizational Behavior*, 24, 779–802.
- Schlegel, R. E., Shehab, R. L., Gilliland, K., Eddy, D. R., Schiflett, D. G. (1993) *Microgravity effects on cognitive performance measures: Practice schedules to acquire and maintain performance stability* (Final Rep. No. A894892). Norman, OK: Oklahoma University.
- Schmidt, L. L, Keeton, K., Slack, K. J., Leveton, L. B., Shea, C. (2009) Chapter 2: Risk of Performance Errors due to Poor Team Cohesion and Performance, Inadequate Selection/Team Composition, Inadequate Training, and Poor Psychosocial Adaptation. In *Human Health and Performance Risks of Space Exploration Missions*, ed. McPhee, J., and Charles, J. B. 45-84, NASA SP-2009-3405.
- Schmidt, L. L., Wood, J., & Lugg, D. J. (2004). Team climate at Antarctic research stations 1996-2000: Leadership matters. *Aviat Space Environ Med*, 75(8), 681–687.
- Schneider, S. M., Amonette, W. E., Blazine, K., Bentley, J., Lee, S. M. C., et al. (2003). Training with the International Space Station Interim Resistive Exercise Device. *Med Sci Sports Exer*, 35(11), 1935–1945.
- Schneider, W. (1985). Training high-performance skills. Fallacies and poor psychosocial adaptation. In guidelines. *Human Factors*, 27(3), 285–300.
- Schneider, W. & Shiffrin, R. (1977). Controlled and automatic human information processing: I. Detection, search, and attention. *Psychological Review*, 84, 1-66.

- See, J. E. & Vidulich, M. A (1997). Assessment of Computer Modeling of Operator Mental Workload during Target Acquisition. In *Proceedings of the Human Factors and Ergonomics Society 41st Annual Meeting*, 2, 1303–1307). Santa Monica, CA: Human Factors and Ergonomics Society.
- Seidler R. D. (2004). Multiple motor learning experiences enhance motor adaptability. *J Cogn Neurosci*. 16: 65–73.
- Seidler, R. D. (2010). Neural Correlates of Motor Learning, Transfer of Learning, and Learning to Learn. *Exercise and Sport Sciences Reviews*, 38: 3-9.
- Seijts, G. H. & Latham, G. P. (2000). The effects of goal setting and group size on performance in a social dilemma. *Canadian Journal of Behavioral Science*, 32, 104–116.
- Sekuler, R. & Blake, R. (2006). *Perception* (5th ed.). New York, NY: McGraw-Hill. (incomplete reference)
- Serfaty, D. & Entin, E. E. (1997). Team adaptation and coordination training. In R. Flin, E. Salas, M. Strub & L. Martin (Eds.), *Decision making under stress: emerging themes and applications* (pp. 170-184). Aldershot, UK: Ashgate.
- Serfaty, D., Entin, E. E., & Johnston, J. H. (1998). Team adaptation and coordination training. In J. A. Cannon-Bowers & E. Salas (Eds.), *Decision making under stress: implications for individuals and team training* (pp. 221-245). Washington, DC: APA Press.
- Serfaty, D., Entin, E. E., & Volpe, C. (1993). Adaptation to stress in team decision-making and coordination, Human Factors and Ergonomics Society 37th Annual Meeting (pp. 1228–1232). Santa Monica: HFES.
- Sexton, J. B. & Helmreich, R. L. (2000). Analyzing cockpit communications: The links between language, performance, error, and workload. *Human Performance in Extreme Environments*, 5(1), 63-68.
- Shackelford, L. C., LeBlanc, A. D., Driscoll, T. B., Evans, H. J., Rianon, N. J., Smith, S. M., Spector, E., Feedback D. L., & Lai, D. (2004). Resistance exercise as a countermeasure to disuse-induced bone loss. *Journal of Applied Physiology*, 97:119-129.
- Shanteau, J. (1988). Psychological characteristics and strategies of expert decision makers. *Acta Psychologica*, 68, 203–215.
- Shaw, J. B., & Barrett-Power, E. (1998). The effects of diversity on small work group processes and performance. *Human Relations*, 51, 1307–1325.
- Shayler, D. A. (2000). *Disaster and accidents in manned spaceflight*. Chichester, UK: Springer/Praxis.
- Shelley, H. (1960). Focused leadership and cohesiveness in small groups. *Sociometry*, 23, 209–216.
- Shepanek, M. (2005). Human behavioral research in space: Quandaries for research subjects and researchers. *Aviat Space Environ Med*, 76(6), B25–30.
- Sheridan, T. V. (2002). *Humans and automation: System design and research issues*. New York, NY: John Wiley & Sons, Inc.
- Shevell, S. K. (Ed.). (2003). *The science of color* (2nd ed.). Amsterdam, The Netherlands: Elsevier.
- Shibata, S., Perhonen, M., Levine, B. D. (2010). Supine cycling plus volume loading prevent cardiovascular deconditioning during bed rest. *J. Appl. Physiol*. 108: 1177–1186.
- Shiffrin, R. M., & Schneider, W. (1977). Controlled and automatic human information processing: II. Perceptual learning, automatic attending and a general theory. *Psychological Review*, 84(2), 127–190.

- Shingledecker, C.A. (1984). A task battery for applied human performance assessment research (Technical Report ADA153677). Wright-Patterson Air Force Base, OH: Air Force Aerospace Medical Research Laboratory.
- Shneiderman, B. (Ed) (1995). *Sparks of Innovation in Human-Computer Interaction*, Norwood, NJ: Ablex Publishers.
- Silverstein, L. D. (2003). Display visibility in dynamic lighting environments: Impact on the design of portable and vehicular displays. Paper presented at the Proceedings of the International Display Manufacturing Conference. (incomplete reference)
- Silverstein, L. D. & Merrifield, R. M. (1985). *The development and evaluation of color systems for airborne applications*. Springfield, VA: National Technical Information Service.
- Simon, H. A. (1973). The structure of ill-structured problems. *Artificial Intelligence*, 4, 181–201.
- Simon, H. (1962). The architecture of complexity. *Proceedings of the American Philosophical Society*, 26; 467-482.
- Simons, T. L. & Peterson, R. S. (2000). Task conflict and relationship conflict in top management teams: The pivotal role of intragroup trust. *J Appl Psychol*, 85(1), 102–111.
- Sirevaag, E., Kramer, A., Wickens, C., et al. (1993). Assessment of pilot performance and mental workload in rotary wing aircraft. *Ergonomics*, 9, 1121–1140.
- Slack, K. J., Shea, C., Leveton, L. B., Whitmire, A., & Schmidt, L. L. (2008). Evidence report on the risk of behavioral and psychiatric conditions. In *Human Research Evidence Book 2008: Behavioral Health and Performance Element*. Houston, TX: National Aeronautics and Space Administration, Johnson Space Center. (incomplete reference)
- Slater, P. E. (1958). Contrasting correlates of group size. *Sociometry*, 21, 129–139.
- Smallman, H. S., & Boynton, R. M. (1990). Segregation of basic colors in an information display. *J Opt Soc Am A*, 7(10), 1985–1994,
http://www.ncbi.nlm.nih.gov/entrez/query.fcgi?cmd=Retrieve&db=PubMed&dopt=Citation&list_uids=2231108
- Smith, A. P., Brice, C., Leach, A., Tiley, M., & Williamson, S. (2004). Effect of upper respiratory tract illnesses in a working population. *Ergonomics*, 47, 363–369.
- Smith, H. P. R. (1979). A simulator study of the interaction of pilot workload with errors, vigilance, and decisions (NASA TM -78482). Moffett Field, CA: NASA Ames Research Center.
- Smith, S. L., & Mosier, J. N. (1986). *Guidelines for designing user interface software*. Bedford, MA: The MITRE Corporation.
- Smith, S.T., Bush, G.A., Stone, L.S.. (2002). Amplitude response of human vestibular heading estimation. *Soc. Neurosci. Abstract*, 56.1.
- Smith-Jentsch, K. A., Campbell, G., Milanovich, D. M., & Reynolds, A. M. (2001). Measuring teamwork mental models to support training needs assessment, development, and evaluation: Two empirical studies. *Journal of Organizational Behavior*, 22(2), 179–194.
- Smith-Jentsch, K. A., Cannon-Bowers, J. A., Tannenbaum, S. I., & Salas, E. (2008). Guided team self-correction: Impacts on team mental models, processes, and effectiveness. *Small Group Research*, 39(3), 303–327.

- Smith-Jentsch, K. A., Zeisig, R. L., Acton, B., & McPherson, J. A. (1998). Team dimensional training: A strategy for guided team self-correction. In J. A. Cannon-Bowers & E. Salas (Eds.), *Making decisions under stress: Implications for individual and team training* (pp. 271–297). Washington, DC: APA.
- Society for Human Performance in Extreme Environments. <http://www.hpee.org/>. Retrieved September 10, 2010.
- Sohlberg, M. M. & Mateer, C. A. (1989). *Introduction to cognitive rehabilitation: theory and practice*. New York, NY: Guilford Press.
- Sperling, G. (1960). The information available in brief visual presentations. *Psychological Monographs: General and Applied*, 74(11), 1-29.
- Speyer, J., Fort, A., Fouillot, J., & Bloomberg, R. (1987) Assessing pilot workload for minimum crew certification. In A. H. Roscoe (Ed.) *The practical assessment of pilot workload*. (AGARDograph No. 282, pp. 139–183). Neuilly-sur-Seine, France: AGARD.
- Stein, E. S. (1984). *The measurement of pilot performance: A master-journeyman approach*. (DOT/FAA/CT-83/15). Atlantic City, NJ: FAA Technical Center.
- Stein, E. S. (1985). Air traffic controller workload: An examination of workload probe, Report No. DOT/FAA/CT-TN84/24, Federal Aviation Administration Technical Center, Atlantic City, NJ.
- Steiner, I. D. (1972). *Group processes process and productivity*. New York, NY: Academic Press.
- Stenger, M. B., Brown, A. K., Lee, S. M. C., Locke, J. P., Platts, S. H. (2010). Gradient compression garments as a countermeasure to post-spaceflight orthostatic intolerance. *Aviat Space Environ Med* 81: 883–887.
- Stenger, M. B., Evans, J. M., Knapp, C. F., Lee, S. M. C., Phillips, T. R., Perez, S. A., Moore, A. D. Jr., Paloski, W. H., Platts, S. H. (2012). Artificial gravity training reduces bed rest-induced cardiovascular deconditioning. *Eur. J. Appl. Physiol.* 112: 605–616.
- Sterman, B. & Mann, C. (1995). Concepts and applications of EEG analysis in aviation performance evaluation. *Biological Psychology*, 40, 115-130.
- Sternberg, S. (1969). Memory-scanning: Mental processes revealed by reaction-time experiments. *American Scientist*, 57, 421–457.
- Stevens, M. J. & Champion, A. M. (1999). Staffing work teams: Development and validation of a selection test for teamwork settings. *Journal of Management*, 25(2), 207–228.
- Stewart, G. L. (2006). A meta-analytic review of relationships between team design features and team performance. *Journal of Management*, 32, 29-54
- Stokes, A. F. & Kite, K. (1994). *Stress and pilot personality. Flight stress: Stress, fatigue, and performance in aviation*. A. Stokes & K. Kite, (Eds.) Aldershot: Ashgate Publishing Limited. 151–94.
- Stokes, A. F., Pharmed, J. A., & Kite, K. (1997). Stress effects upon communication in distributed teams. IEEE International Conference on Systems, Man, and Cybernetics, 5, 4171–4176.
- Stone, L. S. & Krauzlis, R. J. (2003). Shared motion signals for human perceptual decisions and oculomotor actions. *Journal of Vision* 3, 725–36.
- Stone, L. S. & Perrone, J. A. (1997). Human heading estimation during visually-simulated curvilinear motion. *Vision Res*, 37, 573-590.
- Stone, L. S. & Thompson, P. (1992). Human speed perception is contrast dependent. *Vision Res*, 32: 1535-1549.

- Stout, R. J., Cannon-Bowers, J. A., & Salas, E. (1996-7). The role of shared mental models in developing team situational awareness: Implications for training. *Training Research Journal*, 2, 85–116.
- Straus, S. G. & McGrath, J. E. (1994). Does medium matter? The interaction of task type and technology on group performance and member reactions. *J Appl Psychol*, 79(1), 87–97.
- Straw, B. L., Sandelands, I. E., & Dutton, J. E. (1981). Threat-rigidity cycles in organizational behaviour: a multi-level analysis. *Administrative Science Quarterly*, 26, 501–524.
- Streufert, S. & Streufert, S. C. (1981). *Stress and information search in complex decision making: Effects of load and time urgency* (Technical Rep. No. 4). Arlington, VA: Office of Naval Research.
- Stroud, K. J., Harm, D. L., & Klaus, D. M. (2005). Preflight virtual reality training as a countermeasure for space motion sickness and disorientation. *Aviat Space Environ Med*, 76(4), 352–356.
- Strube, M. & Garcia, J. (1981). A meta-analysis investigation of Fiedler's contingency model of leadership effectiveness. *Psychological Bulletin*, 90, 307-321.
- Stuster, J. (1996). *Bold endeavors: Lessons from polar and space exploration*. Annapolis, MD: Naval Institute Press.
- Stuster, J. (2005). Analogue prototypes for lunar and Mars exploration. *Aviat Space Environ Med*, 76(6), B78–83.
- Stuster, J., Bachelard, C., & Suedfeld, P. (2000). The relative importance of behavioral issues during long-duration ICE missions. *Aviat Space Environ Med*, 71(9), A17–A25.
- Sundstrom, E., De Muse, K. P., & Futrell, D. (1990). Work teams: Applications and effectiveness. *American Psychologist*, 45(2), 120–133.
- Svennson, E., Angelborg-Thanderz, M., Sjoberg, L., & Olsson, S. (1996). Information complexity - mental workload and performance in combat aircraft. *Ergonomics*, 40 (3). 362-380.
- Sweller, J. (1994). Cognitive load theory. Learning difficulty and instructional design. *Learning and Instruction*, 12(3), 295–312
- Takahashi, M., Nakata, A., Harakani, T., Ogawa, Y., & Arito, H. (2004). Post-lunch nap as a worksite intervention to promote alertness on the job. *Ergonomics*, 47, 1003–1013.
- Tannen, D. (1990). *You just don't understand: Men and women in conversation*. New York, NY: Ballantine.
- Tetlock, P. E. (1985). Accountability: The neglected social context of judgment and choice. In Cummings, L. L. & Staw, B. M. (Eds.), *Research in organizational behavior: An annual series of analytical essays and critical reviews* (Vol. 7). Greenwich, CT: JAI Press.
- Theologus, G. C., Wheaton, G. R., Mirabella, A., & Brahle, R. E. (1973). Development of a standardized battery of performance tests for the assessment of noise stress effects, American Institutes for Research, Silver Spring, Maryland, distributed by NTIS, January 1973. (NASA CR-2149).
- Thibos, L. N., Applegate, R. A., Schwiegerling, J. T., & Webb, R. (2002). Standards for reporting the optical aberrations of eyes. *J Refract Surg*, 18(5), S652–660.
- Thomas, L.C. & Wickens, C.D. (2004). Eye-tracking and individual differences in unexpected event detection when flying with a Synthetic Vision System Display. In Proceedings 48th Annual Meeting of the Human Factor and Ergonomics Society. Santa Monica, CA: HFES.
- Thompson, C. A. & Klopff, D. W. (1991). An analysis of social style among disparate cultures. *Communication Research Reports*, 8(1-2), 65–72.

- Tilley, A. & Warren, P. (1984). Retrieval from semantic memory during a night without sleep. *The Quarterly Journal of Experimental Psychology: Human experimental psychology*, 36A, 281–289.
- Ting-Toomey, S. (1987). A comparative analysis of the communicative dimensions of love, self-disclosure maintenance, ambivalence, and conflict in three cultures: France, Japan, and the United States, International Communication Association Convention. Montreal.
- Tjosvold, D. (1997). Conflict within interdependence: Its value for productivity and individuality. In C. K. W. DeDreu & E. Van de Vliert (Eds.), *Using conflict in organizations* (pp. 23–37). London, UK: Sage.
- Tomaka, J., Blascovich, J., Kelsey, R. M., & Leitten, C. L. (1993). Subjective, physiological, and behavioral effects of threat and challenge appraisal. *Journal of Personality and Social Psychology*, 65, 248–260.
- Tomeh, A., & Gallant, C. (1984). Family sex role attitudes: A French sample. *Journal of Comparative Family Studies*, 15, 389–405.
- Townes, B. D., Hornbein, T. F., Schoene, R. B., Sarnquist, F. H., & Grant, I. (1984). Human cerebral function at extreme altitude. In J. B. West & S. Lahiri (Eds.), *High altitude and man* (pp. 31–36). Bethesda, MD: American Psychological Society.
- Tran, M. H., Raikundalia, G. K., & Yang, Y. (2006). Using an experimental study to develop group awareness support for real-time distributed collaborative writing. *Information and Software Technology*, 48(11), 1006–1024.
- Trappe, T., Trappe, S., Lee, G., Widrick, J., Fitts, R., Costill, D. (2006). Cardiorespiratory responses to physical work during and following 17 days of bed rest and spaceflight. *J. Appl. Physiol.* 100: 951–957.
- Tredici, T. J. & Ivan, D. J. (2008). Ophthalmology in aerospace medicine. In J. R. Davis (Ed.), *Fundamentals of aerospace medicine* (4th ed., pp. 349-379). Philadelphia, PA: Lippincott Williams & Wilkins.
- Triandis, H. C. (1995). *Individualism and collectivism*. Boulder, CO: Westview.
- Trimmel, M. & Poelzl, G. (2006). Impact of background noise on reaction time and brain DC potential changes of VDT-based spatial attention. *Ergonomics*, 49, 202–208.
- Tsai, Y-F, Virre, C., Strychacz, B., Chase, B., & Jung, T-P (2007). Task performance and eye activity: predicting behavior relating to cognitive workload. *Aviat Space EnvironMed.* 78, 5, II supplement, B 176–185.
- Tsang, P., & Vidulich, M.A. (2006). Mental workload and situation awareness. In G. Salvendy (Ed.), *Handbook of human factors & ergonomics* (pp. 243-268). Hoboken, NJ: Wiley.
- Tsang, P. S. & Wilson, G. (1997). Mental Workload. In G. Salvendy (Ed.) *Handbook of human factors and ergonomics* (2nd ed., pp. 417–449). New York, NY: John Wiley & Sons.
- Turner C. (1998). Three rules for bone adaptation to mechanical stimuli. *Bone*, 23, 399–407.
- Tversky, A. & Sattath, S. (1979). Preference trees. *Psychology Review*, 86, 542-573.
- Tziner, A. & Vardi, Y. (1982). Effects of command style and group cohesiveness on the performance effectiveness of self-selected tank crews. *Journal of Applied Psychology.* 67(6), 769-775.
- Van Dongen, H. P., Maislin, G., Mullington, J. M., & Dinges, D., (2003). The cumulative cost of additional wakefulness: dose-response effects on neurobehavioral functions and sleep physiology from chronic sleep restriction and total sleep deprivation. *Sleep*, 26, 117–126.

- van Knippenberg, D., van Knippenberg, B., & van Dijk, E. (2000). Who takes the lead in risky decision making? Effects of group members' risk preferences and prototypicality. *Organizational Behavior and Human Decision Processes*, 84(2), 213–234.
- van Nes, F. L. & Bouman, M. A. (1967). Spatial modulation transfer in the human eye. *J Opt Soc Am A*, 57, 401–406.
- Varner, D. (1984). Temporal sensitivities related to color theory. *J Opt Soc Am A*, 1, 474–481.
- Vasterling, J. J., Proctor, S. P., Amoroso, P., et al. (2006). Neuropsychological outcomes of Army personnel following deployment to the Iraq War. *The Journal of the American Medical Association*, 296(5), 519–529.
- Veltman, H. A., Verway, W. B. (1996) Detecting short periods of elevated workload: a comparison of nine workload assessment techniques. *Journal of Experimental Psychology – Applied*, 2 (3), 270-285.
- Ververs, P.M. & Wickens, C.D. (2000). Designing head-up displays (HUDs) to support flight path guidance while minimizing effects of cognitive tunneling. In *Proceedings of the IEA 2000/HFES 2000 Congress* (Vol. 3, pp. 3–45). Santa Monica, CA: Human Factors and Ergonomics Society.
- Verwey, W. B. & Veltman, H. A. (1996). Detecting short periods of elevated workload: A comparison of nine workload assessment techniques. *Journal of Experimental Psychology: Applied*, 2(3), 270-285.
- Vicente, K. J., Thornton, D. C., & Moray, N. (1987). Spectral analysis of sinus arrhythmia: a measure of mental effort. *Human Factors*, 29(2), 171-182.
- Vidulich, M. A , & Tsang, P. S. (1987). Absolute magnitude estimation and relative judgement approaches to subjective workload assessment, paper presented at the Human Factors Society 31st Annual Meeting.
- Vidulich, M. A. & Wickens, C. D. (1986). Causes of dissociation between subjective workload measures and performance. *Applied Ergonomics*, 17, 291–296.
- Vidulich, M.A. & Bortolussi, M.R., (1988). Speech recognition in advanced rotorcraft: Using speech controls to reduce manual control overload. In *Proceedings of the National Specialist's Meeting Automation Applications for Rotocraft*. Atlanta, GA: American Helicopter Society, Atlanta Southeast Region, 1-10.
- Viéville, T., Clément, G., Lestienne, F., et al. (1986) Adaptive modifications of the optokinetic vestibulo-ocular reflexes in og. In E. L. Keller & D. S. Zee (Eds.), *Adaptive Processes in Visual and Oculomotor Systems* (pp. 111–120). Pergamon Press, New York, NY: Pergamon Press.
- Vroom, V. H. (2000). Leadership and the decision-making process. *Organizational Dynamics*, 28(4), 82-94.
- Vroom, V. H., & Jago, A. G. (2007). The role of the situation in leadership. *American Psychologist*, 62(1), 17-24.
- Vykukal, H. C. & Dolkas, C. B. (1966). Effects of combined linear and vibratory accelerations on human body dynamics and pilot capabilities. XVIIth International Astronautical Congress, 1966. pp 107.
- Wachtel, P. L. (1968). Anxiety, attention, and coping with threat. *Journal of Abnormal Psychology*, 73, 137–143.
- Wagner, J. A. I. (1995). Studies of individualism and collectivism: Effects on cooperation in groups. *Academy of Management Journal*, 38(1), 152–172.

- Wakertin, M. E., Sayeed, L., & Hightower, R. (1997). Virtual teams versus face-to-face teams: An exploratory study of a web-based conference system. *Decision Sciences*, 28(4), 975–996.
- Wallace, D. F., Anderson, N. S., & Shneiderman, B. (1993). Time stress effects on two menu selection systems. In B. Shneiderman (Ed.), *Sparks of Innovation in Human–Computer Interaction* (pp. 89–97). Norwood, NJ: Ablex Publishing.
- Warm, J. S., Dember, W. N., Hancock, P. A. (1996). Vigilance and workload in automated systems, in: R. Parasuraman & M. Mouloua (Eds.), *Automation and Human Performance* (pp. 183-200). Lawrence Erlbaum Associates, Mahwah, NJ.
- Warren, W. H., Jr., Morris, M. W., & Kalish, M. (1988). Perception of translational heading from optical flow. *J Exp Psychol Hum Percept Perform*, 14(4), 646–60.
- Warren, R. M. (1999). *Auditory perception: A new analysis and synthesis*. New York, NY: Cambridge University Press.
- Watamaniuk, S. N. & Sekuler, R. (1992). Temporal and spatial integration in dynamic random-dot stimuli. *Vision Res*, 32, 2341–2347.
- Watenpaugh, D. E., O’Leary, D. D., Schneider, S. M., Lee, S. M. C., Macias, B. R., Tanaka, K., Hughson, R. L., Hargens, A. R. (2007). Lower body negative pressure exercise plus brief postexercise lower body negative pressure improve post-bed rest orthostatic tolerance. *J. Appl. Physiol.* 103: 1964–1972.
- Waters, W. W., Ziegler, M. G., Meck, J. V. (2002). Postspaceflight orthostatic hypotension occurs mostly in women and is predicted by low vascular resistance. *J. Appl. Physiol.* 92: 586–594.
- Watkins, O. C. & Watkins, M. J. (1980). The modality effect and echoic persistence. *Journal of Experimental Psychology: General*, 109, 251–278.
- Watson, A. B. (1986). Temporal Sensitivity. In K. Boff, L. Kaufman & J. Thomas (Eds.), *Handbook of Perception and Human Performance*. New York, NY: Wiley.
- Watson, A. B. & Ahumada, Jr., A. J. (2005). A standard model for foveal detection of spatial contrast. *Journal of Vision*, 5(9), 717–740, <http://journalofvision.org/5/9/6/>.
- Watson, A. B. & Ahumada, Jr., A. J. (2008). Predicting visual acuity from wavefront aberrations. *Journal of Vision*, 8(4), 1–19, <http://journalofvision.org/8/4/17/>.
- Watson, A. B. & Solomon, J. A. (1997). Model of visual contrast gain control and pattern masking. *J Opt Soc Am A*, 14, 2379–2391, <http://josaa.osa.org/abstract.cfm?id=1940>.
- Watson, A. B., Ahumada, Jr., A. J., & Farrell, J. (1986). Window of visibility: psychophysical theory of fidelity in time-sampled visual motion displays. *J Opt Soc Am A*, 3(3), 300–307.
- Watson, A. B., & Yellott, J. I. (2012). A unified formula for light-adapted pupil size. *Journal of Vision*, submitted.
- Watson, W. E., BarNit, A., & Pavur, R. (2005). Cultural diversity and learning teams: The impact on desire academic team processes. *International Journal of Intercultural Relations*, 29, 440–467.
- Watson, W. E., Johnson, L., & Zgourides, G. D. (2002). The influence of ethnic diversity on leadership, group process, and performance: An examination of learning teams. *International Journal of Intercultural Relations*, 26, 1–16.

- Watson, W. E., Kumar, K., & Michaelsen, L. K. (1993). Cultural diversity's impact on interaction process and performance: Comparing homogeneous and diverse task groups. *Academy of Management Journal*, 36, 590–602.
- Wegner, D. Parasuraman, M., Erber, R., & Raymond, P. (1991). Transactive memory in close relationships. *Journal of Personality and Social Psychology*, 61, 923–929.
- Welch, R. B., Bridgeman, B., Williams, J. A., & Semmler, R. (1998). Dual adaptation and adaptive generalization of the human vestibulo-ocular reflex. *Perception & Psychophysics*, 60, 1415–1425.
- Welford, A. T. (1980). Choice reaction times: Basic concepts. In J.M.T. Brebner & A. T. Welford (Eds.), *Reaction Times* (pp. 73-128). London, UK: Academic Press.
- Welford, A. T. (1980). Relations between reaction time and fatigue, stress, age and stress. In J.M.T. Brebner & A. T. Welford (Eds.), *Reaction Times* (pp. 321-354). London, UK: Academic Press.
- Wenzel, E. M. (1992). Localization in virtual acoustic displays. *Presence*, 1, 80–107.
- Wenzel, E. M. (2004). Current approaches to 3-D sound reproduction. [Invited keynote paper.] Proceedings of the International Congress on Acoustics, Kyoto, Japan. April 4-9, 2004.
- Wenzel, E. M., Arruda, M., Kistler, D. J., & Wightman, F. L. (1993). Localization using non-individualized head-related transfer functions. *Journal of the Acoustical Society of America*, 94, 111–123.
- Wenzel, E. M., Miller, J. D., & Abel, J. S. (2000). Sound lab: A real-time, software-based system for the study of spatial hearing, Proceedings of the 108th Convention of the Audio Engineering Society, Paris, Feb. 2000, New York: Audio Engineering Society, Preprint 5140.
- West, M. A. (1995). Creative values and creative visions in teams at work. In C. M. Ford & D. A. Gioia. Mouloua (Eds.), *Creative action in organizations: Ivory tower visions and real world voices* (pp. 71–77). London, UK: Sage Publications.
- Westheimer, G. & Liang, J. (1995). Influence of ocular light scatter on the eye's optical performance. *J Opt Soc Am A Opt Image Sci Vis*, 12(7), 1417–1424,
http://www.ncbi.nlm.nih.gov/entrez/query.fcgi?cmd=Retrieve&db=PubMed&dopt=Citation&list_uids=7608786.
- White, W. J. & Jorve, W. R. (1956). The effects of gravitational stress upon visual acuity. USAF WADC Tech. Rep.No 56-247.
- Whitmire, A., Leveton, L. B., Barger, L., et al. (2008). Evidence report on risk of performance errors due to sleep loss, circadian desynchronization, fatigue and work overload. In *Human Research Evidence Book 2008: Behavioral Health and Automation and Human Performance Element*. Houston, TX: National Aeronautics and Space Administration, Johnson Space Center (pp. 183–220). Hillsdale, NJ: Lawrence Erlbaum Associates.
- Whittaker, S. & Geelhoed, E. (1993). Shared workspaces: How do they work and when are they useful? *International Journal of Man-Machine Studies*, 39, 813–842.
- Wickens, C. D. & Alexander, A. (in press). Attentional tunneling and task management in synthetic vision displays. *International Journal of Aviation Psychology*.
- Wickens, C. D. & Liu, Y. (1988). Codes and modalities in multiple resources: A success and a qualification. *Human Factors*, 30, 599-616.
- Wickens, C. D. & Yeh, Y. (1988). Dissociation of performance and subjective measures of workload. *Human Factors*, 30, 111-120.

- Wickens, C. D. (1986). The effects of control dynamics on performance. In K. R. Boff, L. Kaufman, & J. P. Thomas (Eds.), *Handbook of perception and performance* (Vol. II, pp. 39-1/39-60). New York: Wiley & Sons.
- Wickens, C. D. & Hollands, J. G. (2000). *Engineering psychology and human performance* (3rd ed.). Columbus, OH: Charles E. Merrill Publishing Company.
- Wickens, C. D. (1984). Processing resources in attention. In R. Parasuraman & D. R. Davies (Eds.), *Varieties of attention* (pp. 63–102). San Diego, CA: Academic Press.
- Wickens, C. D. (2001) Keynote address: Attention to safety and the psychology of surprise. In, Jensen (Ed.), *Proceedings of the 11th International Symposium of Aviation Psychology*. Columbus, OH: The Department of Aerospace Engineering, Applied Mechanics and Aviation, The Ohio State University.
- Wickens, C. D., Goh, J., Helleberg, J., Horrey, W., & Talleur, D. A. (2003). Attentional models of multi-task pilot performance using advanced display technology. *Human Factors*, 45(3), 360–380.
- Wickens, C. D., Hyman, F., Dellinger, J., Taylor, H., & Meador, M. (1986). The Sternberg memory search task as an index of pilot workload. *Ergonomics*, 29, 1371–1383.
- Wickens, C. D., Kramer, A. F., Vanesse, L., & Donchin, E. (1983). The performance of concurrent tasks: A psychophysiological analysis of the reciprocity of information processing resources. *Science*, 221, 1080–1082.
- Wickens, C. D., McCarley, J. S., Alexander, A., Thomas, L., Ambinder, M., & Zheng, S. (2007). Attention-Situation Awareness (A-SA) model of pilot error. In D. Foyle & B. Hooey (Eds.), *Pilot performance models*. Mahwah, N.J: Lawrence Erlbaum.
- Wickens, C. D. (2002). Situation awareness and workload in aviation. *Current Directions in Psychological Science*, 11, 128–133.
- Wickens, C. D. (1991). Processing resources and attention. In D. Damos (Ed.), *Multiple-task performance* (pp. 3–34). London, UK: Taylor & Francis.
- Wickens, C. D. (1996). Designing for stress. In J. Driskell & E. Salas (Eds.), *Stress and human performance* (pp. 279–295). Mahwah, NJ: Lawrence Erlbaum.
- Wickens, C. D. (2002). Multiple resources and performance prediction. Theoretical. *Issues in Ergonomic Sciences*, 3(2), 159–177.
- Wickens, C. D. (2005). Multiple resource time sharing model. In N. A. Stanton, E. Salas, H. W. Hendrick, A. Hedge, & K. Brookhuis (Eds.), *Handbook of human factors and ergonomics methods* (pp. 40–7). Oxford, UK: Taylor & Francis.
- Wickens, C. D., & Colcombe, A. (2007). Dual-task performance consequences of imperfect alerting associated with a cockpit display of traffic information. *Human Factors*, 49, 839-850.
- Wickens, C. D., Dixon, S. R., & Ambinder, M. S. (2006). Workload and automation reliability in unmanned air vehicles. In N. J. Cooke, H. Pringle, H. Pedersen, & O. Connor (Eds.), *Advances in human performance and cognitive engineering research: Vol. 7. Human factors of remotely operated vehicles* (pp. 209-222). Amsterdam: Elsevier.
- Wickens, C. D., Sandry, D., & Vidulich, M. I. (1983). Compatibility and resource competition between modalities of input, central processing, and output: Testing a model of complex task performance. *Human Factors*, 25, 227–228.
- Wickens, C. D., Lee, J. D., Liu, Y., & Gordon Becker, S. E. (2004). *An Introduction to Human Factors Engineering* (2nd ed.). Upper Saddle River, NJ: Pearson Prentice Hall.

- Wiener, E. & Curry, R (1980). Flight-deck automation: promises and problems. *Ergonomics*, 23(10), 995-1011.
- Wiener, E. L., Kanki, B. G., & Helmreich, R. L. (Eds.). (1993). *Cockpit resource management*. San Diego, CA: Academic Press, Inc.
- Wierwille, W. Rahimi, M., & Casali, J (1985). Evaluation of 16 measures of mental workload using a simulated flight task emphasizing mediational activity. *Human Factors*, 17 489–502.
- Wierwille, W. W. (1993). An initial model of visual sampling of in-car displays and controls. In A. G. Gale, I. D. Brown, C. M. Haslegrave, H. W. Krusse, & S. P Taylor (Eds.). *Vision in Vehicles IV*. Amsterdam, The Netherlands: North-Holland.
- Wierwille, W. W., Casali, J., Connor, S. A., & Rahimi, M. (1986) Evaluation of the sensitivity and intrusion of mental workload estimation techniques. In W. Rouse (Ed.) *Advances in Man-machine Systems Research* (Vol 2). Greenwich, CT: JAI Press.
- Wierwille, W. W., Eggemeier, F. T. (1993). Recommendations for mental workload measurement in a test and evaluation environment, *Human Factors* 35(2) 263-281.
- Williams, K. Y. & O'Reilly, C. A. (1998). Demography and diversity in organizations: A review of 40 years of research. *Research in Organizational Behavior*, 20, 77–140.
- Wilson, G. F. & Eggemeier, F.T., (1991) Chapter 12, Psychophysiological assessment of workload in multi-task environments, In D. L. Damos (Eds.) *Task Performance* (pp. 329-360). London, UK: Taylor Francis Inc.
- Wingrove, R. C., Stinnett, G. W., Innis, R. C. (1964). A study of the pilot's ability to control an Apollo type vehicle during atmospheric entry. NASA, Washington D.C. TN D2467.
- Winn, B., Whitaker, D., Elliott, D. B., & Phillips, N. J. (1994). Factors affecting light-adapted pupil size in normal human subjects. *Invest Ophthalmol Vis Sci*, 35(3), 1132–1137,
http://www.ncbi.nlm.nih.gov/entrez/query.fcgi?cmd=Retrieve&db=PubMed&dopt=Citation&list_uids=8125724.
- Wish, M., D'Andrade, R. G., & Goodnow, J. E. (1980). Dimensions of interpersonal communication: Correspondences between structures for speech acts and bipolar scales. *Journal of Personality and Social Psychology*, 39(5), 848–860.
- Wood, J., Schmidt, L. L., Lugg, D. J., Ayton, J., Phillips, T., & Shepanek, M. (2005). Life, survival, and behavioral health in small closed communities: 10 years of studying isolated Antarctic groups. *Aviat Space Environ Med*, 76(6), B89–93.
- Wood, S. J. (2002). Human otolith-ocular reflexes during off-vertical axis rotation: effect of frequency on tilt-translation ambiguity and motion sickness. *Neurosci Lett* 323: 41-44
- Wood, S. J., Loehr, J.A., Guiliams, M.E. (2011). Sensorimotor reconditioning during and after spaceflight. *NeuroRehabilitation* 29: 185-195
- Wood, W. (1987). Meta-analytic review of sex differences in group performance. *Psychological Bulletin*, 102(1), 53–71.
- Wright, P. (1974). The harassed decision maker: Time pressure, distractions, and the use of evidence. *Journal of Applied Psychology*, 59, 555–561.
- Wright, R. D., & Ward, L. M. (2008). *Orienting of Attention*. New York, NY: Oxford University Press.

- Wyszecki, G. & Stiles, W. S. (1982). *Color Science: concepts and methods, quantitative data and formulae*, 17, (2 ed., pp. 86-90). New York, NY: John Wiley and Sons.
- Yamamoto, T. (1984). Human problem solving in a maze using computer graphics under an imaginary condition of "fire." *Japanese Journal of Psychology*, 55, 43–47.
- Yasui, S. & Ohtsuka, T. (1986). Horizontal cell signal is smaller with texture-like nonuniform patterns than with uniform fields of the same space-average illuminance. *Vision Res*, 26(4), 583–598.
- Yates, J. F. & Stone, E. R. (1992). Chapter 1 - The risk construct. In J. F. Yates (Ed.), *Risk-Taking Behavior* (pp. 1-25). Chichester, UK: John Wiley and Sons Ltd.
- Yeh, Y. Y., Wickens, C. D. (1988). Dissociation of performance and subjective measures of workload, *Human Factors* 30; 111–120
- Young, L. R., Sienko, K. H., Lyne, L. E., Hecht, H., & Natapoff, A. (2003). Adaptation of the vestibulo-ocular reflex, subjective tilt, and motion sickness to head movements during short-radius centrifugation. *J Vestib Res*, 13(2-3), 65–77.
- Young, L. R., & Sinha, P. (1998). Spaceflight influences on ocular counterrolling and other neurovestibular reactions. *Otolaryngol Head Neck Surg*, 118, 31–34.
- Young, L. R. (2000). Vestibular reactions to spaceflight: Human factors issues. *Aviat Space Environ Med*, 71, A100–104.
- Zarriello, J. J., Norsworthy, M. E., & Bower, H. R. (1958) *A study of early grayout threshold as an indicator of human tolerance to positive radial acceleratory force*. (Project NM 11-02-11, Subtask 1, Report 1). Pensacola FL: U.S. Naval School of Aviation Medicine.
- Zhang, L. F. (2001). Vascular adaptation to microgravity: what have we learned? *J. Appl. Physiol* 91: 2415–2430.
- Zhang, X.-M., Farrell, J. E., & Wandell, B. A. (1997). Applications of a spatial extension to CIELAB. Paper presented at the Proc. SPIE the International Society for Optical Engineering, 3025, 154-157.,
- Zulley, J. (2000). The influence of isolation on psychological and physiological variables. *Aviat Space Environ Med*, 71, A44–A47
- Zwicker, E. (1961). Subdivisions of the audible frequency range into critical bands. *Journal of the Acoustical Society of America*, 33, 248.

TABLE of CONTENTS

6	NATURAL AND INDUCED ENVIRONMENTS	335
6.1	INTRODUCTION.....	335
6.2	INTERNAL ATMOSPHERE.....	335
6.2.1	Introduction	335
6.2.2	Internal Atmosphere Composition and Pressure.....	335
6.2.2.1	Total Pressure.....	336
6.2.2.1.1	Decompression Sickness	336
6.2.2.1.1.1	Decompression Sickness Research Needs.....	339
6.2.2.1.2	Barotrauma	339
6.2.2.1.3	Total Pressure Limits	341
6.2.2.2	Oxygen	341
6.2.2.2.1	Hypoxia.....	342
6.2.2.2.2	Oxygen Toxicity (Hyperoxia)	344
6.2.2.2.3	Oxygen Level Limits.....	345
6.2.2.3	Carbon Dioxide	347
6.2.2.3.1	Carbon Dioxide Effects.....	347
6.2.2.3.2	Carbon Dioxide Limits.....	349
6.2.2.4	Diluent Gas.....	351
6.2.2.4.1	Metabolic Factors.....	352
6.2.2.4.2	Thermal Factors	352
6.2.2.4.3	Vocal Factors.....	352
6.2.2.4.4	Toxicity Factors.....	352
6.2.2.4.5	Decompression Sickness Factors	353
6.2.2.5	Internal Atmosphere Composition and Pressure Monitoring and Control	353
6.2.2.6	Mission-Related Effects on Internal Atmosphere Composition and Pressure	353
6.2.3	Atmospheric Temperature, Humidity, and Ventilation.....	355
6.2.3.1	Temperature	355
6.2.3.1.1	Heat	355
6.2.3.1.2	Cold	356
6.2.3.1.3	Thermal Limits.....	356
6.2.3.1.4	Expected Metabolic Loads	360
6.2.3.2	Relative Humidity	362
6.2.3.3	Ventilation.....	363
6.2.3.4	Temperature, Humidity, and Ventilation Monitoring and Control	364
6.2.3.4.1	Temperature	364
6.2.3.4.2	Relative Humidity	364
6.2.3.4.3	Ventilation.....	364
6.2.4	Atmosphere Contamination.....	365
6.2.4.1	Biological	366
6.2.4.2	Particulates	368
6.2.4.3	Toxic Substances.....	368

6.2.4.3.1	Derived Toxic Substances	371
6.2.4.3.2	Fluid Systems	371
6.2.4.3.3	Combustion Events	371
6.2.4.3.3.1	Fire Prevention	372
6.2.4.3.3.2	Fire Detection	372
6.2.4.3.3.3	Fire Extinguishing	373
6.2.4.3.4	Off-Gassing	375
6.2.4.3.5	Propellants	375
6.2.5	Research Needs	376
6.3	WATER.....	377
6.3.1	Introduction	377
6.3.2	Water Quality	377
6.3.2.1	Water Contamination	377
6.3.2.1.1	Chemical Contaminants.....	379
6.3.2.1.2	Microbiological Contaminants	379
6.3.2.2	Water Quality Limits.....	380
6.3.2.2.1	Chemical Limits	380
6.3.2.2.2	Microbial Limits.....	382
6.3.2.2.3	Aesthetic Limits.....	383
6.3.2.3	Shelf Life.....	384
6.3.3	Water Quantity.....	385
6.3.4	Water Temperature.....	386
6.3.5	Water Quality Monitoring.....	387
6.3.5.1	Preflight Materials Evaluations and Testing	387
6.3.5.2	Preflight Monitoring	387
6.3.5.3	In-Flight Monitoring.....	388
6.3.5.4	Archive or Postflight Monitoring	388
6.3.5.5	Microbial Water Monitoring	389
6.3.6	Water Contamination Control and Remediation	390
6.3.7	Other Considerations	392
6.3.7.1	Water Sources	392
6.3.7.2	Water Access	392
6.3.7.3	Water Dispensing	392
6.3.8	Research Needs	393
6.4	CONTAMINATION	394
6.4.1	Introduction	394
6.4.2	Contamination Type.....	394
6.4.3	Contamination Hazards.....	395
6.4.4	Contamination Monitoring and Control	395
6.4.5	Biological Payloads.....	397
6.4.6	Research Needs	397
6.5	ACCELERATION	398
6.5.1	Introduction	398
6.5.2	Rotational Velocity and Acceleration	400
6.5.2.1	Rotational Velocity and Acceleration Regimes	400

6.5.2.2	Effects of Rotational Motion on Humans	400
6.5.2.3	Rotational Velocity and Acceleration Exposure Limits.....	402
6.5.2.4	Countermeasures for Rotational Velocity and Acceleration	403
6.5.3	Sustained Translational Acceleration	403
6.5.3.1	Sustained Translational Acceleration Regimes	403
6.5.3.2	Effects of Sustained Translational Acceleration on Humans	404
6.5.3.3	Sustained Translational Acceleration Exposure Limits.....	408
6.5.3.4	Countermeasures for Sustained Translational Acceleration	411
6.5.4	Transient Translational Acceleration	413
6.5.4.1	Transient Translational Acceleration Regimes	413
6.5.4.2	Effects of Transient Translational Accelerations on Humans.....	414
6.5.4.3	Transient Translational Acceleration Exposure Limits.....	415
6.5.4.3.1	Brinkley Dynamic Response Method	415
6.5.4.3.2	New NASA Method for Occupant Protection.....	419
6.5.4.3.2.1	Brinkley Limitations	420
6.5.4.3.2.2	Injury Assessment Reference Values	422
6.5.4.3.2.3	Injury Assessment Reference Values	427
6.5.4.3.2.4	Determination of Assessment Cases.....	427
6.5.4.3.3	Occupant Protection Considerations	429
6.5.4.3.3.1	Deconditioning	429
6.5.4.3.3.2	Gender and Anthropometry	430
6.5.4.3.3.3	Pressure Suit.....	430
6.5.4.4	Countermeasures for Transient Translational Acceleration	431
6.5.5	Research Needs	432
6.6	ACOUSTICS	433
6.6.1	The Acoustic Environments of Spacecraft.....	433
6.6.1.1	Launch.....	434
6.6.1.2	Atmospheric Entry	436
6.6.1.3	On-Orbit Engine Burns	436
6.6.1.4	On-Orbit, Lunar, or Planetary Acoustic Environment.....	436
6.6.1.5	Extravehicular Activity Acoustic Environment	438
6.6.2	Human Response to Noise	439
6.6.2.1	Physiological Effects.....	439
6.6.2.2	Performance Effects	439
6.6.2.2.1	Interference with Speech Communications.....	439
6.6.2.2.1.1	Signal-to-Noise Ratio	440
6.6.2.2.1.2	Intelligibility Tests	440
6.6.2.2.1.3	Speech Interference Levels	440
6.6.2.2.2	Interference with Task Performance	442
6.6.2.3	Annoyance Effects	443
6.6.3	Human Exposure and Acoustic Environment Limits.....	444
6.6.3.1	Noise Exposure Limit for Intrinsic High Noise Level or Off-Nominal and Contingency Conditions.....	444
6.6.3.2	Hazardous Noise Level Limit for Intrinsic High Noise Level or Off- Nominal and Contingency Conditions.....	445
6.6.3.3	Noise Limit for Personal Communication Devices.....	446

6.6.3.4	Sound Pressure Level Limits for Continuous Noise During Nominal Operations	446
6.6.3.5	Sound Pressure Level Limits for Intermittent Noise During Nominal Operations	449
6.6.3.6	Hazardous Noise Levels During Nominal Operations	450
6.6.3.7	Tonal and Narrow-Band Noise Limits	450
6.6.3.8	Reverberation Time.....	450
6.6.3.9	Impulse Noise Limits	451
6.6.3.10	Infrasonic Noise Limits.....	452
6.6.3.11	Ultrasonic Noise Limits	452
6.6.3.12	Loudspeaker Alarm Audibility.....	452
6.6.4	Noise Control of Spacecraft	453
6.6.4.1	Noise Control Plan	453
6.6.4.1.1	Noise Control Strategy	453
6.6.4.1.2	Noise Sources.....	453
6.6.4.1.3	Noise Paths.....	454
6.6.4.1.4	Noise at the Receiver Location	454
6.6.4.1.5	Acoustic Analysis.....	455
6.6.4.1.6	Testing and Verification	456
6.6.4.2	Noise Control Design Applications.....	456
6.6.4.2.1	Noise Control at the Source	458
6.6.4.2.2	Path Noise Control	458
6.6.4.2.3	Noise Control in the Receiving Space.....	462
6.6.4.2.4	Post-Design Mitigation.....	463
6.6.5	Verification of Acoustic Requirements	464
6.6.6	Acoustic Monitoring of Spacecraft	464
6.6.7	Acoustic Countermeasures – Hearing Protection.....	465
6.6.8	Acoustics Definitions	465
6.6.9	Research Needs	465
6.7	VIBRATION.....	466
6.7.1	Background	466
6.7.1.1	Scope	466
6.7.1.1.1	Nomenclature	466
6.7.1.1.2	Coordinate Systems.....	468
6.7.1.2	Human Vibration in Spaceflight Environments	470
6.7.1.2.1	Vibration Environment Considerations.....	471
6.7.1.2.2	Pre-Launch Phase Vibration Environment.....	472
6.7.1.2.3	Launch Phase Vibration Environment.....	472
6.7.1.2.4	On-Orbit Phase Vibration Environment.....	473
6.7.1.2.5	Entry, Descent, and Landing Phase Vibration Environments	473
6.7.2	Health, Comfort, and Perception.....	474
6.7.2.1	Human Responses to Vibration.....	474
6.7.2.2	Physiological Effects of Vibration	474
6.7.2.3	Discomfort/Annoyance Effects of Vibration.....	476
6.7.2.4	Weighted Vibration for Health Limits, Discomfort, and Motion Sickness	479

6.7.2.4.1	Comparison with Historical Exposure Criteria Nomenclature	484
6.7.2.5	Comfort Limits (0.5 to 80 Hz)	485
6.7.2.6	Low Frequency Vibration Limits (0.1 to 0.5 Hz)	485
6.7.2.6.1	Severe Discomfort Boundary (0.1 to 0.5 Hz).....	486
6.7.2.6.2	Decreased Proficiency Boundary	486
6.7.2.6.3	Reduced Comfort Boundary.....	486
6.7.3	Performance	487
6.7.3.1	Performance Impacts of Vibration.....	487
6.7.3.2	Visual Performance Effects.....	487
6.7.3.3	Manual Performance Effects	489
6.7.3.4	Vibration Exposure Performance Limits.....	489
6.7.3.4.1	Gemini Program	489
6.7.3.4.2	Apollo Program.....	491
6.7.3.4.3	Constellation Program.....	492
6.7.4	Vibration Design Considerations	496
6.7.4.1	Human Responses to Vibration Plus G Loading.....	496
6.7.4.2	Vibration Design Guidelines.....	498
6.7.4.2.1	General Vibration Design Guidelines	498
6.7.4.2.2	Example Vibration Design Solutions.....	498
6.7.4.2.3	Vibration Countermeasures.....	499
6.7.4.2.3.1	Vibration Control at the Source	499
6.7.4.2.3.2	Control of Vibration – Path Transmission	501
6.7.4.2.3.3	Vibration Protection	502
6.7.4.3	Vibration Requirement Development and Verification	503
6.7.5	Research Needs	505
6.8	IONIZING RADIATION	508
6.8.1	Introduction	508
6.8.2	Space Ionizing Radiation Environment.....	508
6.8.2.1	Units	508
6.8.2.2	Sources	509
6.8.2.2.1	Solar Radiation.....	510
6.8.2.2.2	Galactic Cosmic Radiation.....	515
6.8.2.2.3	Trapped Particles.....	517
6.8.2.2.3.1	Low Earth Orbit	519
6.8.2.2.3.2	High Earth Orbit.....	520
6.8.2.3	Lunar Missions.....	520
6.8.2.4	Planetary Missions	521
6.8.2.5	Extravehicular Activity	522
6.8.2.6	Radioactive Devices.....	522
6.8.2.6.1	Sealed Sources	522
6.8.2.6.2	Power Sources.....	522
6.8.2.6.3	Induced Radioactivity.....	523
6.8.3	Physiological Effects of Ionizing Radiation Exposure.....	523
6.8.3.1	Human Response	524
6.8.3.1.1	Early Effects.....	525
6.8.3.1.2	Late Effects	527

6.8.3.1.3	Dose Rate	528
6.8.3.1.4	Risk and Desensitization	528
6.8.4	Exposure Limits for Ionizing Radiation	529
6.8.4.1	ALARA Mandate	529
6.8.4.2	Early-Effect Dose Limits	529
6.8.4.3	Late-Effect Dose Limits	530
6.8.5	Protection from Ionizing Radiation	531
6.8.5.1	Planning	532
6.8.5.2	Shielding	532
6.8.5.2.1	Lunar Considerations	534
6.8.5.2.2	Martian Considerations	535
6.8.5.3	Radiation Analysis and Design	537
6.8.5.4	Countermeasures	538
6.8.6	Radiation Monitoring and Alerting	538
6.8.6.1	Active Radiation Monitoring	539
6.8.6.1.1	Dose Rate Monitoring	539
6.8.6.1.2	EVA Monitoring	540
6.8.6.1.3	Charged-Particle Monitoring	540
6.8.6.1.4	Monitoring of Absorbed Dose and Dose Equivalent	541
6.8.6.2	Passive Radiation Monitoring	541
6.8.6.3	Personal Dosimetry	541
6.8.6.4	Biodosimetry	542
6.8.7	Radiation Data Reporting	542
6.8.8	Research Needs	543
6.9	NON-IONIZING RADIATION	545
6.9.1	Introduction	545
6.9.2	Non-Ionizing Radiation Sources	546
6.9.2.1	Natural NIR Sources	546
6.9.2.2	Human-Made NIR Sources	548
6.9.3	Effects of Non-Ionizing Radiation Exposure on Humans	548
6.9.4	Human Exposure Limits for Non-Ionizing Radiation	549
6.9.4.1	Radio Frequency Limits	550
6.9.4.2	Coherent Radiation – Lasers	553
6.9.4.2.1	Limits for Ocular Exposure to Lasers	555
6.9.4.2.2	Limits for Dermal Exposure to Lasers	558
6.9.4.3	Incoherent Radiation – UV, Visible, and IR	559
6.9.4.3.1	Limits for Retinal Thermal Injury from Visible and Near-Infrared Sources	560
6.9.4.3.2	Retinal Photochemical Injury from Visible Light	561
6.9.4.3.2.1	Small-Source Visible Radiation Limits	561
6.9.4.3.2.2	Large-Source Visible Radiation Limits	561
6.9.4.3.3	Limits for Thermal Injury from Infrared Radiation	561
6.9.4.3.4	Limits for Ultraviolet Exposure for Unprotected Eye or Skin	562
6.9.5	Hazard Controls for Non-Ionizing Radiation Effects	562
6.9.6	Research Needs	563
6.10	REFERENCES	564

TABLE of FIGURES

Figure 6.2-1. Hypoxia and hyperoxia danger zones at different volumes of oxygen and at depths below and altitudes above sea level. (From Woodson et al., 1991.).....	342
Figure 6.2-2. Hypoxia and hyperoxia danger zones at different volume percentages of oxygen in atmosphere and at different total pressures of that atmosphere. (From Tobias, 1967.)	342
Figure 6.2-3. Impairment of visual functions produced by hypoxia. (From Roth and Benjamin, 1968).....	344
Figure 6.2-4. Approximate time of appearance of hyperoxic symptoms as a function of O ₂ partial pressure. (From Parker and West, 1973.).....	345
Figure 6.2-5. Effects of increased carbon dioxide inhalation. (From Tobias, 1967.)	348
Figure 6.2-6. Relationship of alveolar O ₂ and CO ₂ composition to performance.....	349
Figure 6.2-7. Environmental comfort zone	357
Figure 6.2-8. Heat storage zones for comfort, performance impairment, and tolerance.	359
Figure 6.2-9. Space Station Eyewash.	366
Figure 6.2-10. Russian OKP-1.	375
Figure 6.3-1 Diverse challenges to water quality in space flight.	378
Figure 6.5-1 Example of the Apollo hang angle (adapted from Whitnah & Howes, 1971)	399
Figure 6.5-2 Example of the Gemini hang angle (Adapted from Vincze, 1966)	399
Figure 6.5-3 Angular velocity limits.	403
Figure 6.5-4 +G _x sustained or short-term plateau translational acceleration limits.	408
Figure 6.5-5 -G _x sustained or short-term plateau translational acceleration limits.	409
Figure 6.5-6 +G _z sustained or short-term plateau translational acceleration limits.	409
Figure 6.5-7 -G _z sustained or short-term plateau translational acceleration limits.....	410
Figure 6.5-8 +/-G _y sustained or short-term plateau translational acceleration limits.	410
Figure 6.5-9 Critical point definition for seated occupant.	418
Figure 6.5-10 Methods of estimating and assessing human injury risk.	423
Figure 6.5-11 Mercury capsule landing bag (impact skirt)	432
Figure 6.6-1 Measured Space Shuttle orbiter crew module maximum noise during launch phase (NASA-STD-3000, 1995).....	435
Figure 6.6-2 Space Shuttle orbiter internal noise. Noise in the flight deck during the atmospheric launch phase as a function of time, analyzed using a 4-second time window (Nealis, 1982).	435
Figure 6.6-3 Talker-to-listener distances for just-reliable communication. The A-weighted sound level shown below the abscissa is approximate. The relation between speech interference level and A-weighted sound level depends on the spectrum of the noise (ANSI S12.65-2006).....	441
Figure 6.6-4 Noise criterion (NC) curves. Corresponding A-weighted sound pressure levels and speech interference levels are given for reference only (Beranek, 1992; ANSI/ASA S12.2-2008). SIL(4) is speech interference level, 4-band method	447
Figure 6.6-5 Percent of key words in sentences correctly understood. Key words in sentences correctly understood as a function of the NC curve for male talkers with normal	

voices at a face-to-face distance of 5 to 8 feet on board the Space Shuttle (Pearson, 1975).	448
Figure 6.6-6 Reverberation time as a function of room volume (Farrell, 1975).	451
Figure 6.6-7 Space Shuttle approach to estimating continuous noise in the crew compartment.	457
Figure 6.6-8 Space Shuttle noise paths.	458
Figure 6.6-9 ISS US Laboratory intermodule ventilation fan muffler	459
Figure 6.6-10 Space Shuttle inertial measurement unit cooling fan mufflers.	459
Figure 6.6-11 Space Shuttle inertial measurement unit muffler attenuation.	460
Figure 6.6-12 NASA muffler for the Functional Cargo Block.	460
Figure 6.6-13 ISS Avionics Air Assembly fan and packaging.....	461
Figure 6.6-14 ISS Rack with Pump Package Assembly.....	461
Figure 6.6-15 Duct wrapping of the Minus Eighty Degree Laboratory Freezer.	462
Figure 6.6-16 US Laboratory Melamine [®] and Solimide [®] absorbing cushion applications	463
Figure 6.7-1 Examples of sinusoid (top), sum-of-sines (middle), and random (bottom) vibration waveforms.....	467
Figure 6.7-2 Acceleration environment coordinate system.....	469
Figure 6.7-3 Short-term vibration tolerance.....	477
Figure 6.7-4 Frequency weighting functions: (top) W_k for body z-axis, (middle) W_d for body x- and y-axes, (bottom) W_f for motion sickness. Unshaded regions of each plot indicate applicable frequency range for each weighting function. [This adapted excerpt is taken from ISO 2631-1:1997, figure 2 on page 11, with the permission of ANSI on behalf of ISO. © ISO 2013 - All rights reserved].....	481
Figure 6.7-5 Vibration exposure health guidance. [This adapted excerpt is taken from ISO 2631-1:1997, figure B.1 on page 22, with the permission of ANSI on behalf of ISO. © ISO 2013 - All rights reserved.].....	483
Figure 6.7-6 Astronaut ratings of performance degradation as a function of 11-Hz vibration amplitude superimposed on 3.8-Gx bias. [Adapted from (Vykukal & Dolkas, 1966)]	490
Figure 6.7-7 Fine- and coarse-scale dial reading error rates by general-population observers as a function of vibration amplitude (11-Hz fundamental and overall signal with harmonic distortion) superimposed on 3.8-Gx bias. [Adapted from (Clarke et al., 1965)]	490
Figure 6.7-8 Tolerance limits to equivalent sinusoidal vibration (g_x) for visual monitoring of critical displays during launch.	491
Figure 6.7-9 Maximum tolerable limits of vibration (g_x) for visual activity and toggle switch manipulation during launch.	492
Figure 6.7-10 Mean response times (left) and error rates (right) for the general- population participants during (solid symbols and lines) and immediately after (open symbols and dashed lines) vibration at each of the five levels.	493
Figure 6.7-11 Objectively measured error rates (top row) and response times (bottom row) for astronaut participants are shown separately for 10- (left column) and 14-pt (right column) displays superimposed over subjective display usability judgment boundaries.	494

Figure 6.7-12 Proportion of Bedford rating responses in each ordinal category (1-9). Colors indicate primary Bedford workload categories (green: satisfactory; yellow: tolerable but not satisfactory; red: not tolerable). Numbers in parentheses indicate median rating across participants for that vibration level.	495
Figure 6.7-13 Sources of vibration.....	500
Figure 6.7-14 Vibration control methods at the source.....	501
Figure 6.7-15 Control of path vibration.	502
Figure 6.8-1 Energies of various single-charged radiation sources (Schimmerling & Curtis, 1978).....	510
Figure 6.8-2 Event-integrated integral fluence spectra of SPE of September 29, 1989 (Kim et al., 1999)	511
Figure 6.8-3 Projected range in aluminum of protons of various energies.....	512
Figure 6.8-4 Approximate 11-year solar cycle (http://sidc.oma.be/index.php)	513
Figure 6.8-5 Predictions of the number of sunspots in Solar Cycle 24.	514
Figure 6.8-6 Organ doses versus aluminum shield thickness in deep space for 1859 event, based on the August 1972 spectrum.....	515
Figure 6.8-7 Fluence of GCR at solar maximum and minimum vs. Aug. 1972 solar event.	516
Figure 6.8-8 Plots of the solar cycle (dots) and corresponding neutron measurements at the Kerguelen Islands (solid line).	517
Figure 6.8-9 World map of the AP-8 MAX integral proton flux >10 MeV at 500 km altitude (http://www.spennis.oma.be/spennis/help/background/traprad/traprad.html)	518
Figure 6.8-10 GCR dose equivalents as a function of orbit inclination (Silberg et al., 1984)	520
Figure 6.8-11 Doses (H) received behind different shields. $H(x)$, dose behind shield of density x ; $H(0)$, dose with no shield (Wilson et al., 1995)	533
Figure 6.8-12 Effectiveness of lunar regolith shielding (Wilson et al., 1997).....	535
Figure 6.8-13 BFO dose inside a habitat as a function of regolith shield thickness.....	537
Figure 6.9-1 The electromagnetic spectrum (Graf, 1974).....	545
Figure 6.9-2 Spectral distribution curves for solar optical radiation (Thompson, 1986).....	547
Figure 6.9-3 RF electromagnetic field exposure limits (illustrating whole-body resonance effects around 100 MHz). Modified from IEEE International Committee on Electromagnetic Safety (2005)	552

TABLE of TABLES

Table 6.2-1 Standard Sea-Level Atmosphere (Wet)	335
Table 6.2-2 Types of Ear Problems Encountered During Change in Barometric Pressure	340
Table 6.2-3 Physiological Total Pressure Limits for Crew Exposure (NASA/TP-2010-216134)	341
Table 6.2-4 Effects of Hypoxia	343
Table 6.2-5 Oxygen Partial Pressure Levels*	346
Table 6.2-6 Spacecraft Maximum Allowable Concentrations for CO ₂	349
Table 6.2-7 Industrial and U.S. Navy Recommended Limits for CO ₂	350
Table 6.2-8 Constellation Program Partial Pressure CO ₂ Limits for Crew Exposure	351
Table 6.2-9 Core Temperature Range Limits and Associated Performance Decrements	355
Table 6.2-10 Crew-Induced Metabolic Loads for a Standard Mission Day with Exercise	361
Table 6.2-11 Crew-Induced Metabolic Loads for a Standard Mission Day, No Exercise	361
Table 6.2-12 Relative Humidity Exposure Times	362
Table 6.2-13 Microbial Contaminant Levels	366
Table 6.2-14 Criteria for Assignment of Toxicological Hazard Levels (JSC 26895, 1997)	369
Table 6.3-1 Water Chemical Contamination Sources	378
Table 6.3-2 Comparison of Chemical Contaminants of Concern from Different Potable Water Sources	379
Table 6.3-3 Potable Water Physiochemical Limits	381
Table 6.3-4 Potable Water Microbiological Limits for Missions of Less Than 30 Days	383
Table 6.3-5 Potable Water Microbiological Limits for the International Space Station	383
Table 6.3-6 Potable Water Aesthetic Limits	384
Table 6.3-7 Minimum Quantity Needs for Potable Water	385
Table 6.3-8 Water Temperatures	386
Table 6.4-1 NASA In-flight Biosafety Levels (JSC 63828)	397
Table 6.5-1 Inertial Resultant of Body Acceleration	398
Table 6.5-2 Angular Motion During Space Flight	400
Table 6.5-3 Effects of Rotational Motion on Humans	401
Table 6.5-4 Sustained Translational Acceleration Regimes	404
Table 6.5-5 Physiological Effects of Sustained Translational Acceleration	406
Table 6.5-6 Aircraft Transient Acceleration Levels	414
Table 6.5-7 Tolerance of Humans to Impact	414
Table 6.5-8 Approximate Risk Values for the Brinkley Model	415
Table 6.5-9 Brinkley Model Coefficients	417
Table 6.5-10 Dynamic Response Limits	419
Table 6.5-11 Definition of Acceptable Risk	423
Table 6.5-12 Comparison of Human Injury Risk Methods	423
Table 6.5-13 Table of Sample THOR IARVs	427
Table 6.6-1 Speech Levels for Male and Female Voices at a 1-Meter Distance	439
Table 6.6-2 Speech Interference Level (SIL) and Effect on Communication	442
Table 6.6-3 Octave Band Sound Pressure Level Limits for Continuous Noise, dB re 20 μ Pa	449
Table 6.6-4 Intermittent Noise A-Weighted Sound Pressure Level and Corresponding Operational Duration Limits for Any 24-Hour Period	449
Table 6.6-5 Ultrasonic Noise Limits Given in One-Third Octave Band SPLs	452

Table 6.7-1 Commonly Used Terms	470
Table 6.7-2 Body Components and Resonant Frequencies.....	475
Table 6.7-3 Vibration Frequencies for Discomfort Symptoms	479
Table 6.7-4 Discomfort Ratings [Adapted from (ISO, 1997a)]	485
Table 6.7-5 Vibration Frequencies Affecting Human Performance.....	487
Table 6.7-6 Combined Stress – Vibration and Other Environmental Factors.....	497
Table 6.8-1 Weighting (Quality) Factors for Radiation with Different LET	509
Table 6.8-2 Weighting Factors for Different Tissues.....	524
Table 6.8-3 Dose Levels for Various Early Effects.....	526
Table 6.8-4 Dose Limits for Short-Term or Career Non-Cancer Effects (in mGy-Eq or mGy)	529
Table 6.8-5 Example Career Effective Dose Limits for 1-yr Mission for Women and Men and 95% Confidence Level	530
Table 6.8-6 Average Number of Years Lost Due to Doses Corresponding to a 3% REID.....	531
Table 6.8-7 Lunar and Martian Regolith Compositions.....	535
Table 6.8-8 Thickness of CO ₂ at Various Altitudes on Mars.....	536
Table 6.8-9 BFO Dose (cSv) on the Surface of Mars With Only Atmospheric and Minimal Craft Shielding	536
Table 6.9-1 Wavelength Ranges of Non-ionizing Radiation	546
Table 6.9-2 Effects of NIR on Humans.....	549
Table 6.9-3 Lower-Tier Maximum Permissible Exposure (MPE) to Radio Frequency Electromagnetic Fields.....	551
Table 6.9-4 Maximum Permissible Exposure (MPE) for Point Source Ocular Exposure to a Laser Beam (ANSI Z136.1 2007).....	556
Table 6.9-5 Maximum Permissible Exposure (MPE) for Extended Source Ocular Exposure (ANSI Z136.1 2007).....	557
Table 6.9-6 Maximum Permissible Exposure (MPE) for Skin Exposure to a Laser Beam	559
Table 6.9-7 Non-Ionizing Radiation Hazard Control Methods.....	563

6 NATURAL AND INDUCED ENVIRONMENTS

6.1 INTRODUCTION

This chapter discusses design considerations for ensuring crew health and safety throughout a space mission, to protect the crew from the natural environments of space flight such as the atmosphere and space radiation, and induced environments such as acceleration, vibration, acoustics, and human-made non-ionizing radiation.

6.2 INTERNAL ATMOSPHERE

6.2.1 Introduction

This section discusses the composition of the internal atmosphere of spacecraft, and includes data on safe atmospheric composition, total pressure, limits on contaminants, and atmospheric temperature, humidity, and airflow.

Additional considerations for an extravehicular activity (EVA) pressure suit atmosphere are discussed in section 11, “Extravehicular Activity.”

6.2.2 Internal Atmosphere Composition and Pressure

Maintaining a habitable atmosphere in a spacecraft includes providing the proper atmospheric constituents in the proper quantities necessary to sustain life. At sea level on Earth, the atmosphere is composed of approximately 78.1% nitrogen (N₂), 20.9% oxygen (O₂), 0.93% argon (Ar), and several trace gases including carbon dioxide (CO₂) and water vapor, with a total atmospheric pressure of 101 kPa (14.7 psi) (Table 6.2-1).

Table 6.2-1 Standard Sea-Level Atmosphere (Wet)

Parameter	Standard Sea-Level Atmosphere Values			
	kPa	psi	mmHg	% by volume
Total Pressure	101	14.7	760	100
Oxygen Partial Pressure	21.2	3.07	159	20.9
Nitrogen Partial Pressure	79.2	11.5	594	78.1
Ar Partial Pressure	0.90	0.13	7	0.93
Water Vapor Partial Pressure	1.03	0.15	7.6	1.00
CO ₂ Partial Pressure	0.03	0.01	0.3	0.03

However, humans can survive in a wide range of atmospheric compositions and pressures. Atmospheres deemed sufficient for human survival are constrained by the following basic considerations:

- Total pressure must be sufficient to prevent the vaporization of body fluids (ebullism), which occurs at 6.27 kPa (0.91 psi, 47.0 mmHg) at 37°C (98.6°F) (normal body temperature).

- Oxygen must be at a suitable partial pressure for metabolic use.
- Oxygen partial pressure must be low enough to prevent oxygen toxicity.
- For durations in excess of 2 weeks at low pressures, some physiologically inert gas must be provided to prevent atelectasis.
- All other atmospheric constituents must be physiologically inert or of low enough concentration to preclude toxic effects.
- The breathing atmosphere must have minimal flame or explosive hazard.

More restrictive limits may be applied to atmospheric parameters to ensure crew health.

6.2.2.1 Total Pressure

Atmospheric pressure refers to the pressure of the surrounding gases that are applied equally to the entire body. Besides the danger of exposure to pressures below 6.27 kPa (0.91 psi, 47.0 mmHg) at 37°C (98.6°F), human tolerance to high pressure is limited, presumably due to changes in biomolecular conformations and inactivation of critical enzymes (Waligora et al., 1994). The current maximum pressure endurance for humans is well above what is expected in the spaceflight environment. The only time a total pressure above 101 kPa (14.7 psia, 760 mmHg) would be expected would be for the therapeutic treatment of decompression sickness (DCS).

Selecting spacecraft cabin pressure is difficult because of several competing needs, including safe O₂ content, the ratio of cabin pressure to spacesuit pressure for minimizing the risk of DCS, and several engineering constraints including structural integrity to maintain cabin pressure, gas density for cooling, and gas concentration for minimizing flammability. A lower pressure limit, around 55.2 kPa (8.00 psia, 414 mmHg), can enhance operational capability for EVA by reducing prebreathe time without increasing DCS risk, as well as potentially reduce the amount of atmosphere consumed through leakage. The most significant health concerns regarding atmospheric pressure are DCS and barotrauma.

6.2.2.1.1 Decompression Sickness

DCS occurs when the inert gas (typically N₂) that is dissolved in body tissues under pressure forms bubbles on exposure to decreased pressure. If the rate of depressurization is great enough, bubbles may become trapped as they leave the tissues and cause several kinds of problems. During space missions, DCS may occur because of a slow cabin depressurization due to a leak, but is more likely to occur during EVA, since there is a transition from cabin pressure to a lower suit pressure.

DCS can be classified as type I (mild), type II (serious), and arterial gas embolism. Type I DCS is characterized by itching or mild pain, especially in a joint or tendon area, that begins to resolve within 10 minutes of onset. Type II DCS is more serious because it involves the nervous system, and can create pulmonary and circulatory problems. Symptoms are variable and diverse, and may be delayed by as much as 36 hours. Arterial gas embolism occurs when small gas bubbles expand as pressure decreases, and may become lodged in coronary, cerebral, or other arterioles, possibly causing myocardial infarction, stroke, or seizure. Within the first 4 hours of an altitude decompression, the majority of people who will express a sign or symptom of DCS will have done so since denitrogenation, a treatment for DCS, continues during the altitude exposure.

The precise conditions under which a particular individual will develop symptoms of DCS are impossible to predict. The tissue tension of the diluent gas at any particular time will depend on the initial and final equilibrium tensions, the solubility of the diluent in the subject tissues, and the rate and duration of decompression. For example, hypobaric DCS from a normal sea-level atmosphere will occur typically only after decompression below 65.4 kPa (9.48 psia, 490 mmHg). This “threshold” pressure for DCS will vary with the susceptibility of the individual to influence by any of the following risk factors:

- Body Build – Obesity may increase susceptibility to DCS, since N₂ is more readily absorbed in fatty tissue.
- Temperature – Cold may increase susceptibility (Macmillian, 1999). A correlation has been found at ambient temperatures between 20°C (68°F) and 30°C (86°F), and DCS incidence is doubled at much lower temperatures (–20 °C / -4°F) (Heimback & Sheffield, 1996).
- Previous Exposures to Low Pressure – Repeated exposures to hyperbaric conditions may increase susceptibility to DCS depending on the nature of the exposure. Second altitude exposure within 3 hours was found to greatly increase risk, but the effect of repeated daily exposure is not known (Heimback & Sheffield, 1996).
- Dehydration – The role of dehydration as an isolated risk factor has not been established, but inadequate hydration may contribute to DCS risk by increasing blood viscosity. Aspirin is used to help prevent DCS by reducing platelet aggregation.
- Age – A threefold increase in incidence of DCS has been observed in going from the age groups 19–25 years to 40–45 years, possibly because of circulatory changes with age (Macmillian, 1999).
- Gender – Data from chamber exposures indicates that women may be more susceptible to DCS than men (0.224% in women versus 0.049% in men, a 4.6-fold increase). Additional research is needed at higher altitudes under identical conditions with both genders to enable comparisons of DCS susceptibility (Pilmanis & Webb, 1996).
- Exercise – The effect of exercise is roughly equivalent to the effect of an increase of 914 to 1524 meters (3,000 to 5,000 feet) in the altitude of exposure (Macmillian, 1999; Heimback & Sheffield, 1996). However, exercise during EVA prebreathe periods using 100% O₂ produces higher blood flow and is recommended to help eliminate trapped N₂ in body tissues.
- Injury – Perfusional changes in an injured area, particularly in a joint, may create an increased susceptibility to DCS.

When too much diluent gas is dissolved into tissue, some gas must be removed from tissue before decompression occurs, to avoid DCS. Displacing N₂ with O₂ is used to accomplish this, by breathing 100% (or at least > 95%) O₂ for a short period before planned decompression. Oxygen is used for this “prebreathing” since it has a high rate of use by tissue, ensuring that it does not contribute significantly to the formation or growth of bubbles in tissue. If a diluent gas other than N₂ is used, then the risk of using it and measures to reduce the risk must be investigated.

The International Space Station (ISS) uses four prebreathe protocols with the 29.7 kPa (4.30 psia, 222 mmHg) Extravehicular Mobility Unit (EMU) suit. A different prebreathe protocol is used for the Russian Orlan suit since it has a higher operating pressure of 40.0 kPa, (5.80 psia, 300 mmHg). The selection of protocols for a given EVA depends on the mission objectives, DCS risk, crew timeline, and overall operational risks. The four prebreathe protocols for EMU are:

- Exercise – Exercising while breathing 100% O₂ has been shown to more quickly eliminate N₂ from the body tissues. The protocol includes exercising on a Cycle Ergometer with Vibration Isolation and Stabilization (CEVIS) for 10 minutes of an 80-minute mask prebreathe of 100% O₂, with cabin pressure starting at 101 kPa (14.7 psia, 760 mmHg), and decompressing the airlock to 70.3 kPa (10.2 psia, 527 mmHg) over the 20 or more minutes needed to don the suit, followed by a 60-minute in-suit prebreathe that is completed before the airlock begins its purge to vacuum.
- Airlock Campout – This is a 2-day protocol. On the first day, crewmembers preparing for EVA use a mask to prebreathe 100% O₂ for 60 minutes while pressure in the airlock decompresses from 101 kPa (14.7 psia, 760 mmHg) to 70.3 kPa (10.2 psia, 527 mmHg). On the second day, 8 hours and 40 minutes after 70.3 kPa (10.2 psia, 527 mmHg) is reached in the airlock, a 70-minute mask prebreathe of 100% O₂ is performed, and is followed by a final 50-minute in-suit prebreathe.
- In-suit Light Exercise (ISLE) – For the ISLE protocol, the crewmember does not engage in a short bout of intense prebreathe exercise on the CEVIS prior to suit donning at 70.3 kPa (10.2 psia, 527 mmHg) but instead performs a longer bout of mild exercise in the EMU. The ISLE prebreathe protocol shares many steps with the Exercise prebreathe protocol but differs from the latter in that 40 minutes are spent breathing 100% O₂ by mask, followed by a 20-minute depressurization to 70.3 kPa (10.2 psia, 527 mmHg). Once the crewmember has completed suit donning, there is a repressurization to 101 kPa (14.7 psia, 760 mmHg) followed by in-suit arm and leg motions performed for 50 minutes at a minimum O₂ consumption of 6.8 ml•kg⁻¹•min⁻¹. An additional 50 minutes of in-suit rest completes the prebreathe protocol, followed by a 30-minute depressurization of the airlock to vacuum.
- 4-hour In-Suit Prebreathe – Includes 4 hours of unbroken breathing of 100% O₂ at an airlock pressure above 86.2 kPa (12.5 psia, 646 mmHg).

Rapid and appropriate intervention is required to optimize the outcome for a crewmember affected by DCS. In the case of a depressurization, the spacecraft must be capable of pressurizing from vacuum to nominal spacecraft pressure within 20 minutes. Beyond 20 minutes, higher pressures are required to address DCS symptoms. The U.S. Navy Treatment Table 6 is the terrestrial standard for treating DCS. However, the terrestrial standard will not be achievable, nor required, in space because the resources required to support it would be prohibitive, and the expected outcome from sub-terrestrial-standard therapy is likely to be adequate for “altitude-induced” DCS symptoms. Instead, treatment vessels for the delivery of hyperbaric oxygen may include pressure suits, airlocks, and spacecraft habitable volumes, which may be used independently or in combination to achieve specified pressures.

After the initial treatment of DCS symptoms with hyperoxic pressure, it is usually necessary to provide follow-on treatment with higher levels of pressure for treatment of unresolved or recurrent DCS symptoms, or prevention of recurrent symptoms. To prevent progression of DCS symptoms or the development of DCS-induced deficits or aftereffects, in cases of unresolved or recurrent DCS symptoms, it is necessary to provide prompt pressure to the crewmember, above that of the starting spacecraft pressure. Rapid and appropriate intervention is required to optimize the outcome for the affected crewmember(s).

The DCS treatment pressure may be achieved by a combination of pressure vessels to include maximal spacecraft or airlock pressure + maximal suit pressure. A pressure of at least 157 kPa (22.7 psia, 1174 mmHg) should be provided to match current DCS treatment capability on the ISS consisting of 101 kPa (14.7 psia, 760 mmHg) spacecraft pressure + 55.2 kPa (8.00 psia, 414 mmHg) EMU suit pressure when operating the Bends Treatment Apparatus (BTA). If maximal operating lunar pressure is assumed to be 72.4 kPa (10.5 psia, 543 mmHg) + suit is 56.5 kPa (8.20 psia, 424 mmHg), then the airlock or portable chamber would need to provide an additional 27.6 kPa (4.00 psia, 207 mmHg) of pressure to meet the 157 kPa level.

The treatment plan for affected crewmembers will also include specific diagnostic and therapeutic procedures, including guidance for decisions on return contingencies. Additionally, plans will be needed for terrestrial response for returning crewmember(s) with DCS, if the in-flight response is inadequate for treatment.

Late-onset or severe DCS requires higher pressures to treat, but for maximum effectiveness, pressure must still be administered as quickly as possible after the onset of symptoms. In a scenario where the spacecraft cannot maintain pressure, such as an uncontrolled cabin depressurization contingency, then 157 kPa (22.7 psia, 1174 mmHg) DCS treatment pressure will not be obtainable. In this case, provisions should be made to produce a minimum of 55.2 kPa (8.00 psia, 414 mmHg) greater than ambient pressure for a minimum of 6 hours.

6.2.2.1.1.1 Decompression Sickness Research Needs

Although DCS risk has been mitigated on the ISS, the mechanisms of space flight-induced DCS are still not well understood. Research needs to determine why there is a lower risk of DCS while living and performing EVA in microgravity as compared to a terrestrial gravity environment on the Moon or Mars. This reduced risk could include differences in bubble nucleation mechanisms or N₂ washout. New Exploration architectures include different vehicles, EVA suits, and pressure/gas mixtures, and will therefore require new research for vetting and validation of safety of these new systems. The use of intermittent recompression combined with shorter, more frequent EVA has been proposed as a DCS mitigation strategy, and also needs to be evaluated.

6.2.2.1.2 Barotrauma

Barotrauma occurs when gas trapped in body tissues and cavities is subjected to changes in internal pressure, and the resultant pressure difference across cavity walls causes pain or tissue damage. Barotrauma can occur with relatively low pressure differences and slow decompression and recompression rates. Cavities such as the ears, sinuses, and teeth with cavities or fillings are especially vulnerable.

The rate of change of total internal spacecraft pressure must be limited to between –207 kPa (–30.0 psi; –1552 mmHg)/min and 93.1 kPa (+13.5 psi, 698 mmHg)/min during nominal

operations to prevent injury to crewmembers' ears and lungs during depressurization and repressurization. In microgravity, the danger is greater because head and sinus congestion may already be present; therefore, the limit on the rate of increasing pressure is more conservative than the U.S. Navy dive manual limit for descent rate of 310 kPa (45.0 psi; 2327 mmHg)/min, which corresponds to 100 ft (30 m) per minute. The negative limit is consistent with the U.S. Navy dive manual ascent rate limit of 66 ft (20 m) per minute (–207 kPa [–30.0 psi; –1552 mmHg]/min). On the Space Shuttle, the maximum rate of pressure change during nominal cabin decompression and recompression for EVA preparation was 0.10 psi/s, and for emergency recompression the rate, was limited to 1.00 psi/s. Ear problems associated with change in barometric pressure are listed in Table 6.2-2.

Table 6.2-2 Types of Ear Problems Encountered During Change in Barometric Pressure

Differential pressure mmHg	Differential pressure psid	Symptom
0	0	No sensation
3-5	0.06-0.12	Feeling of fullness in ears
10-15	0.19-0.29	More fullness, lessened sound intensity
15-30	0.29-0.58	Fullness, discomfort, tinnitus in ears: ears pop as air leaves middle ear; desire to clear ears – if accomplished, symptoms stop
30-60	0.58-1.16	Increasing pain, tinnitus, dizziness, and nausea
60-80	1.16-1.55	Severe and radiating pain, dizziness, and nausea
~100	~1.93	Voluntary ear clearing becomes difficult or impossible
200 +	3.87+	Eardrum ruptures

When decompression happens very rapidly, more severe injury is likely, especially in the lungs and other air-filled cavities. The injury caused by rapid decompression depends on the rate of pressure change, the initial and final pressure levels, and the overall amounts of air in the lungs and throughout the body. The causes of rapid decompression may be a puncture of the spacecraft by debris (in orbit, or at high altitude during launch or entry), damage to and failure of windows and hatches, or the deployment of a launch or entry escape system. Explosive decompression was a concern during early Space Shuttle missions that included an ejection escape system. The maximum altitude for ejection of unsuited crewmembers was limited because of decompression concerns.

The rate of pressurization during hyperbaric treatment must not result in a differential pressure across a crewmember's chest in excess of 80 mmHg (1.55 psid), or in excess of 40 mmHg (0.77 psid) for a period longer than 5 seconds. Decompression scheduling and gas composition changes in the chamber depend on atmospheric composition. Oxygen toxicity is the main concern with hyperbaric therapy regimes.

6.2.2.1.3 Total Pressure Limits

The total pressure limits in Table 6.2-3, developed by the Exploration Atmosphere Working Group to reduce the risk of DCS, must be met throughout a mission.

Table 6.2-3 Physiological Total Pressure Limits for Crew Exposure (NASA/TP-2010-216134)

Total Pressure (kPa)	Total Pressure (mmHg)	Total Pressure (psia)	Exposure Time
Pressure \leq 20.7	Pressure \leq 155	Pressure \leq 3.00	0
20.7 < Pressure \leq 29.6	155 < Pressure \leq 222	3.00 < Pressure \leq 4.30	12 hours
29.6 < Pressure \leq 51.7	222 < Pressure \leq 387	4.30 < Pressure \leq 7.50	14 days
51.7 < Pressure \leq 103	387. < Pressure \leq 776	7.50 < Pressure \leq 15.0	Indefinite
103 < Pressure \leq 117	776 < Pressure \leq 879	15.0 < Pressure \leq 17.0	12 hours
Pressure > 117	Pressure > 879	Pressure > 17.0	Contingency only

6.2.2.2 Oxygen

[*The information in this section is currently under evaluation and an update is planned for the next revision of this document.](#)

The partial pressure of oxygen at sea level on Earth is 158 mmHg (3.06 psia), which is reduced to 104 mmHg (2.01 psia) at the alveoli (the site of gas exchange) in the lungs. Although people can live continuously at an altitude of 12,000 ft (3,658 m) with an alveolar oxygen pressure of 54.3 mmHg (1.05 psia), this is possible only with acclimatization, and performance is reduced. Too little oxygen (hypoxia) induces sleepiness, headache, the inability to perform simple tasks, and loss of consciousness. Too much oxygen (hyperoxia) can also be harmful. Prolonged breathing of pure oxygen at sea-level pressure (and perhaps even at lower pressures) can eventually produce inflammation of the lungs, respiratory disturbances, various heart symptoms, blindness, and loss of consciousness. Figures 6.2-1 and 6.2-2 show atmospheric pressure and percent oxygen combinations where hypoxia and hyperoxia are likely to occur.

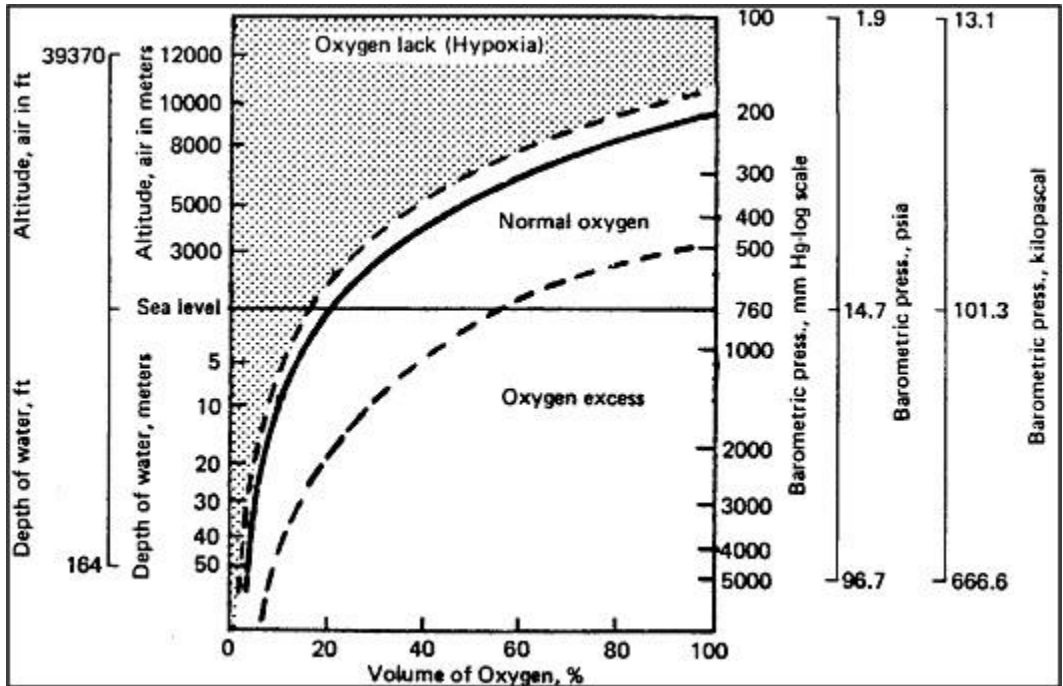


Figure 6.2-1. Hypoxia and hyperoxia danger zones at different volumes of oxygen and at depths below and altitudes above sea level. (From Woodson et al., 1991.)

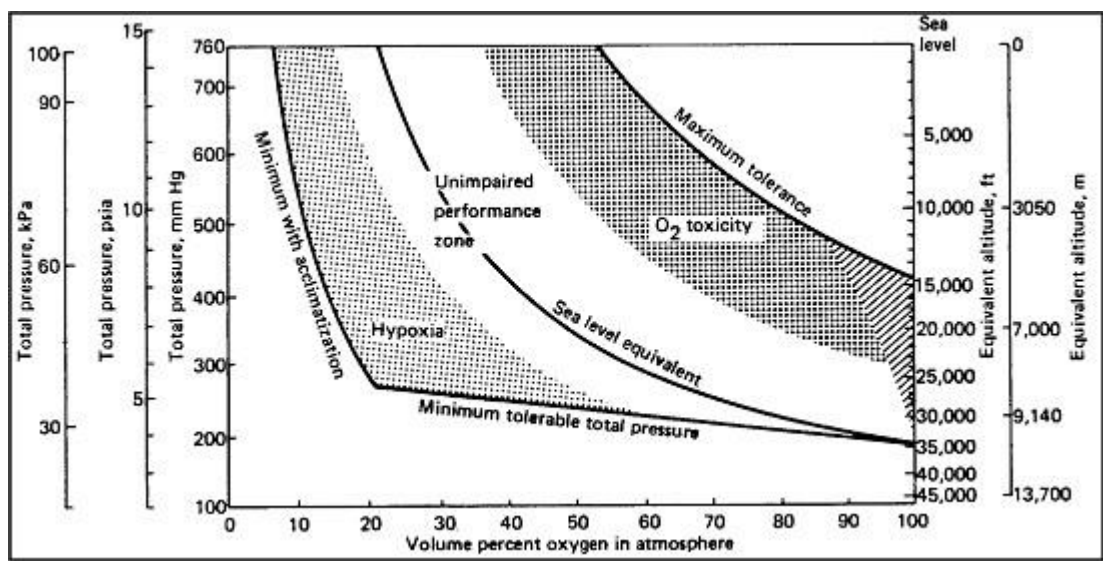


Figure 6.2-2. Hypoxia and hyperoxia danger zones at different volume percentages of oxygen in atmosphere and at different total pressures of that atmosphere. (From Tobias, 1967.)

6.2.2.2.1 Hypoxia

*The information in this section is currently under evaluation and an update is planned for the next revision of this document.

Inadequate oxygen can affect humans at an alveolar oxygen partial pressure of 85 mmHg (1.65 psi), beginning with reduced low-illumination color vision. Below this level, down to around 69 mmHg (1.33 psi), mental performance, such as learning novel tasks, is degraded. Visual, mental, and motor impairment increase as oxygen levels decrease, until consciousness begins to be affected around 35 mmHg (0.67 psi) (Waligora et al., 1994).

Alveolar partial pressure can be calculated for any atmosphere using the equation:

$$PAO_2 = FiO_2(Pb-47) - PCO_2 * (FiO_2 + 1 - FiO_2/0.85)$$

where PAO_2 = alveolar partial pressure of oxygen

FiO_2 = oxygen fraction in the breathing atmosphere

Pb = barometric pressure of the breathing mixture

0.85 = assumed respiratory exchange ratio

PCO_2 = partial pressure of CO_2

Table 6.2-4 lists some effects of hypoxia on humans at approximate atmospheric oxygen partial pressures.

Table 6.2-4 Effects of Hypoxia

Oxygen partial pressure (mmHg)	Oxygen partial pressure (psia)	Effect
160	3.09	Normal (sea-level atmosphere).
137	2.65	Accepted limit of alertness. Loss of night vision. Earliest symptom is dilation of the pupils.
114	2.20	Performance seriously impaired. Hallucinations, excitation, apathy.
100	1.93	Physical coordination impaired, emotionally upset, paralysis, loss of memory.
84	1.62	Eventual irreversible unconsciousness.
0-46	0-0.89	Anoxia – near-immediate unconsciousness, convulsions, paralysis. Death in 90 to 180 seconds.

Note: The effect of falling oxygen pressure is insidious, as it dulls the brain and prevents realization of danger.

The visual functions of a human are particularly sensitive to hypoxia. The retina is the most oxygen-sensitive tissue in the body. Figure 6.2-3 shows some thresholds of visual determination.

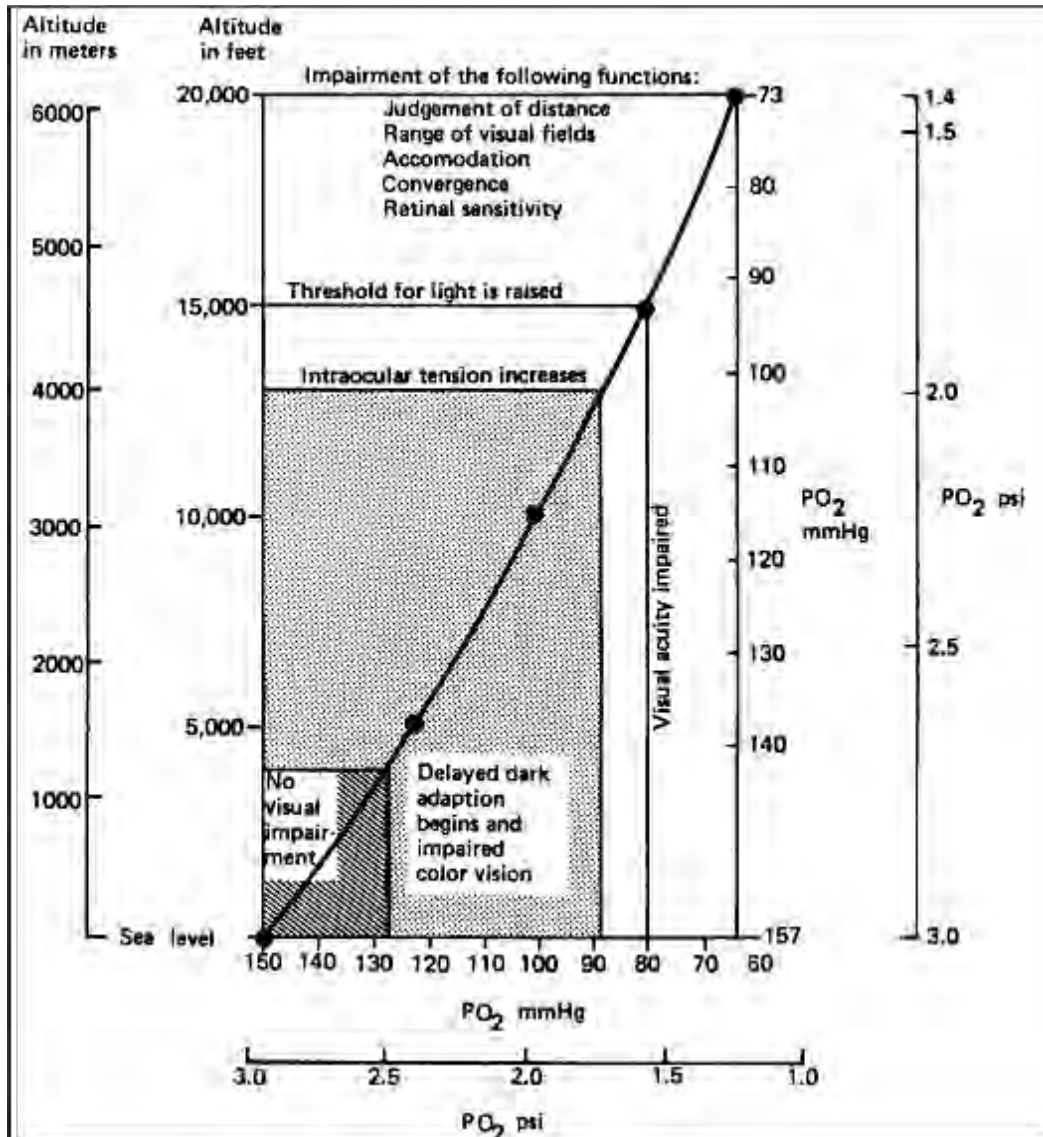


Figure 6.2-3. Impairment of visual functions produced by hypoxia. (From Roth and Benjamin, 1968)

The Space Shuttle maintained oxygen at 166 mmHg (3.2 ± 0.25 psi), and oxygen masks were donned if the oxygen pressure fell below 121 mmHg (2.3 psi).

6.2.2.2.2 Oxygen Toxicity (Hyperoxia)

Molecular oxygen (O_2) can also manifest toxic effects at high partial pressures (ppO_2). Figure 6.2-4 shows times to onset of symptoms. As shown in the figure, the symptoms in this region will generally be respiratory. At pressures of oxygen around 251 mmHg (4.85 psia), changes in red blood cell fragility and cell wall permeability have been reported after long periods of exposure.

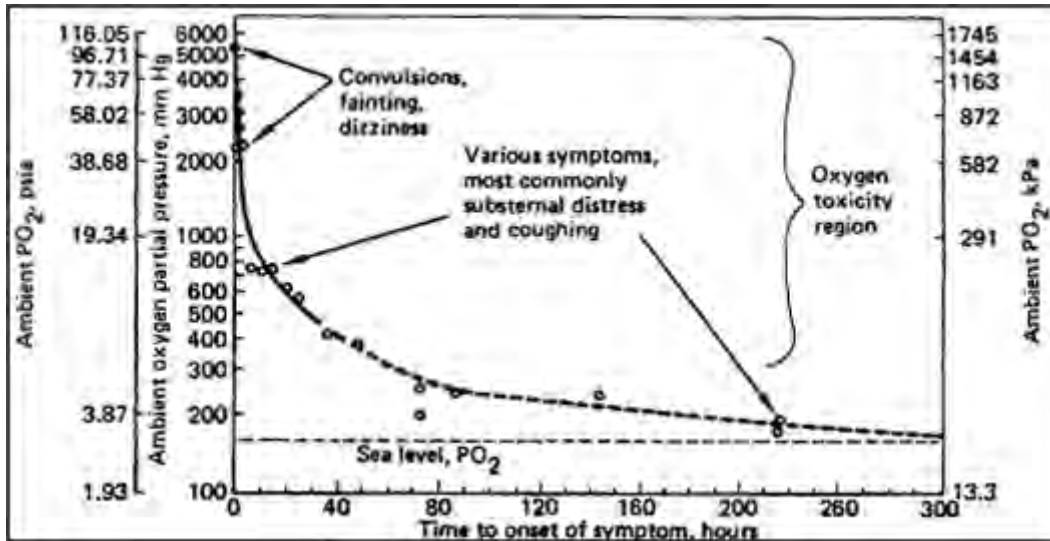


Figure 6.2-4. Approximate time of appearance of hyperoxic symptoms as a function of O₂ partial pressure. (From Parker and West, 1973.)

6.2.2.2.3 Oxygen Level Limits

Spacecraft must support atmospheric ppO₂ levels as defined in Table 6.2-5 to ensure adequate delivery of O₂ to the pulmonary alveoli from inspired oxygen and minimize the risk of hyperoxia.

Limits for ppO₂ levels below 2.50 psia (126 mmHg) prevent hypoxia, whereas those above 3.40 psia (178 mmHg) prevent hyperoxia.

The lower levels represent the minimum ppO₂ needed to maintain the alveolar pressure of oxygen equivalent to that of breathing air at a range of altitudes from approximately 3,000 to 10,000 feet (914-3048 m), at which degradation in performance is expected to occur with acute changes.

Maintaining oxygen partial pressure between 2.70 psia (139 mmHg) and 3.4 psia (178 mmHg) ensures that crewmembers will be comfortable performing on-orbit tasks requiring mental alertness and concentration, and will be able to sustain physically demanding cardiopulmonary and muscular loading such as that performed during countermeasure exercises or EVA. This range prevents performance decrements and toxicity that would be induced by insufficient or excess oxygen partial pressures. The U.S. Occupational Safety and Health Administration (OSHA) specifies that the minimum O₂ level for entry into an enclosed space is 19.5% at sea-level pressure (ppO₂ 148 mmHg [2.86 psi]; equivalent 2,000 ft [609 m]). The range of ppO₂ available to be breathed on Earth by >80% of the world's population is 145-178 mmHg (2.80-3.44 psi), equivalent to sea level to 3,000 ft (914 m) altitude. This is the ppO₂ recommended for extended nominal space flight operations by several space biomedical sources. Joint U.S. and Russian biomedical sourcebooks recommend keeping spacecraft ppO₂ above 128 mmHg (2.48 psia) (below the equivalent flight altitude of approximately 6,000 ft [1829 m]) to allow the performance of physical work in the face of cardiovascular and vestibular effects of weightlessness.

Table 6.2-5 Oxygen Partial Pressure Levels*

ppO₂ (kPa)	ppO₂ (mmHg)	ppO₂ (psia)	Maximum time allowed
ppO ₂ > 82.7	ppO ₂ > 620	ppO ₂ > 12.0	≤ 6 hours
70.3 < ppO ₂ ≤ 82.7	527 < ppO ₂ ≤ 620	10.2 < ppO ₂ ≤ 12.0	≤ 18 hours
60.7 < ppO ₂ ≤ 70.3	456 < ppO ₂ ≤ 527	8.80 < ppO ₂ ≤ 10.20	≤ 24 hours
33.1 < ppO ₂ ≤ 60.7	251 < ppO ₂ ≤ 456	4.80 < ppO ₂ ≤ 8.80	≤ 48 hours
23.4 < ppO ₂ ≤ 33.1	178 < ppO ₂ ≤ 251	3.40 < ppO ₂ ≤ 4.80	≤ 14 days
18.6 < ppO ₂ ≤ 23.4	139 < ppO ₂ ≤ 178	2.70 < ppO ₂ ≤ 3.40	Nominal physiological range. Indefinite with no measurable impairments.
17.2 < ppO ₂ ≤ 18.6	126 < ppO ₂ ≤ 139	2.50 < ppO ₂ ≤ 2.70	Indefinite with measurable performance decrements until acclimatized (after 3 days).
15.2 < ppO ₂ ≤ 17.2	112 < ppO ₂ ≤ 126	2.2 0< ppO ₂ ≤ 2.50	1 hour, unless complete acclimatization, otherwise risk acute mountain sickness.
ppO ₂ ≤ 15.2	ppO ₂ ≤ 112	ppO ₂ ≤ 2.20	Not allowed. Supplemental O ₂ is required to perform tasks without significant impairment.

***The numbers in this table are currently under evaluation and an update is planned for the next revision of this document.**

The minimum limit for O₂ partial pressure of 16.8 kPa (2.44 psia, 126 mmHg) without acclimatization is set at approximately 9,000 ft (2,743 m) altitude equivalent. This level is set below the 10,000-ft (3048 m) altitude level where oxygen masks are required per Federal Aviation Administration (FAA) and Department of Defense (DoD) requirements, and is set to reduce the likelihood of development of acute hypoxic symptoms such as acute mountain sickness. With continued exposure to less oxygen than stated in the table limits, especially with increasing level of activity, a risk of acute altitude sickness may result. The limits are in accordance with international standards, and with variations in total cabin pressure that affect the partial pressure of oxygen. Russian standards for hypoxia limits allow exposure to 16.0 kPa (2.32 psia, 120 mmHg) to 18.7 kPa (2.71 psia, 140 mmHg) O₂ for a maximum of 3 days.

The lowest ppO₂ level in Table 6.1-5 represents an O₂ equivalent altitude (breathing air) of 10,000 ft (3048 m). Rapid ascents to 10,000 ft cause an incidence of mild to moderate altitude sickness in 20% to 40% of those ascending. The risk of altitude sickness is increased principally

because of the reduced alveolar ppO_2 and to a lesser degree because of the decrease in the ambient air pressure. The 10,000-ft (3048-m) altitude equivalent (14.8 kPa ppO_2) represents the maximal altitude that DoD and commercial FAA pilots may fly without supplemental O_2 (accepted masking level).

It is important to note that an increased fire hazard is involved in using enriched (>21%) O_2 atmospheres as the method of maintaining this alveolar partial pressure, because of the increased flammability of typical cabin interior non-metallic materials.

6.2.2.3 Carbon Dioxide

**The information in this section is currently under evaluation and an update is planned for the next revision of this document.*

Carbon dioxide (CO_2) is present on Earth at sea level in concentrations of about 0.03%. Since CO_2 is a product of respiration, its concentration increases in confined areas, especially if they are poorly ventilated.

6.2.2.3.1 Carbon Dioxide Effects

No minimum atmospheric CO_2 requirement for human existence has been set, but too much CO_2 can cause symptoms such as headache, nausea, rapid breathing, and increased heart rate. Figure 6.2-5 shows effects of increased CO_2 concentration on respiration volume and rate, and on pulse (heart) rate. It has been noted that individuals with a relatively large tidal volume and slow respiratory rate show less respiratory and sympathetic nervous system response while breathing low concentrations of CO_2 . At very high levels, CO_2 exposure can lead to confusion, convulsions, and loss of consciousness.

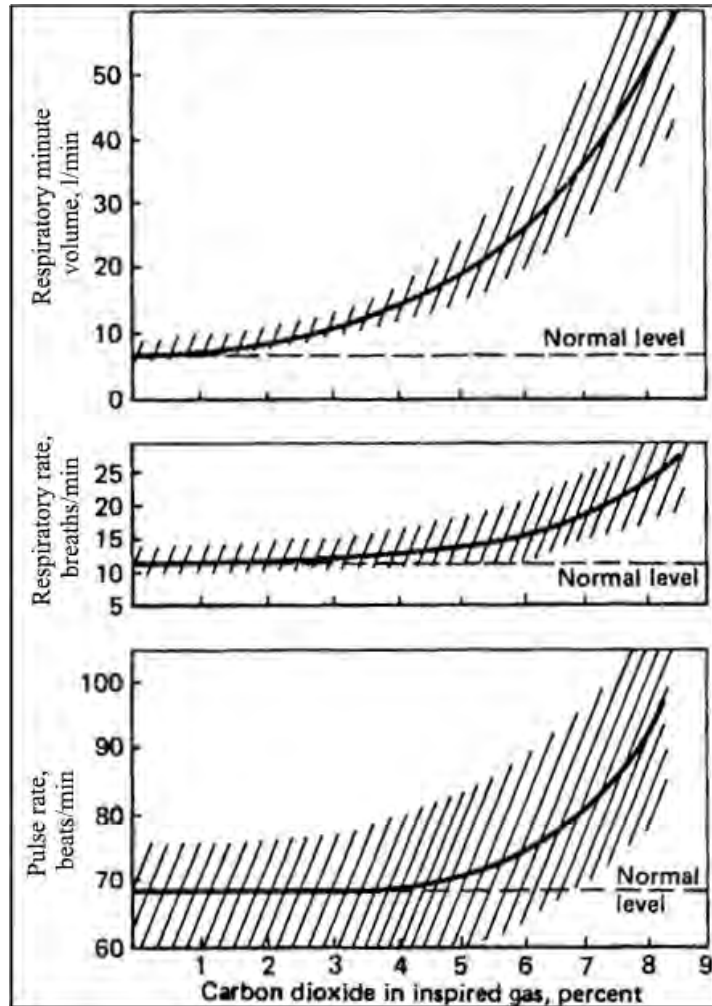


Figure 6.2-5. Effects of increased carbon dioxide inhalation. (From Tobias, 1967.)

CO₂ withdrawal symptoms can be experienced after the cessation of certain exposures to CO₂ and can result in even greater functional impairment than the exposure itself. Headaches of varying severity are common and may be potentiated by the fluid shifts associated with operations in microgravity. Withdrawal from more acute exposures may cause dizziness. Symptoms are more marked during acute exposures to 5% to 10% CO₂ than during chronic exposures to CO₂ concentrations below 3%. In the extreme case, profound hypertension and grave cardiac arrhythmias may occur. It has been observed that subjects recover from CO₂ exposure better when breathing O₂ than when breathing air.

The Space Shuttle limited CO₂ partial pressure levels to 7.8 mmHg (0.15 psia), and the crew donned breathing masks if the level exceeded 16 mmHg (0.30 psia). Due to lack of natural convection in microgravity, spacecraft may develop areas with low atmospheric circulation, which could result in a localized area of increased CO₂. In addition, combustion events can contribute to overall CO₂ levels in the spacecraft.

In Figure 6.2-6, alveolar partial pressure of CO₂ is plotted against alveolar partial pressure of O₂. Shown on the graph are relationships between atmospheric CO₂-O₂ composition and human

performance response. The normal 36 mmHg (0.7 psia) alveolar partial pressure corresponds to approximately 3 mmHg (0.06 psia) of CO₂ cabin partial pressure.

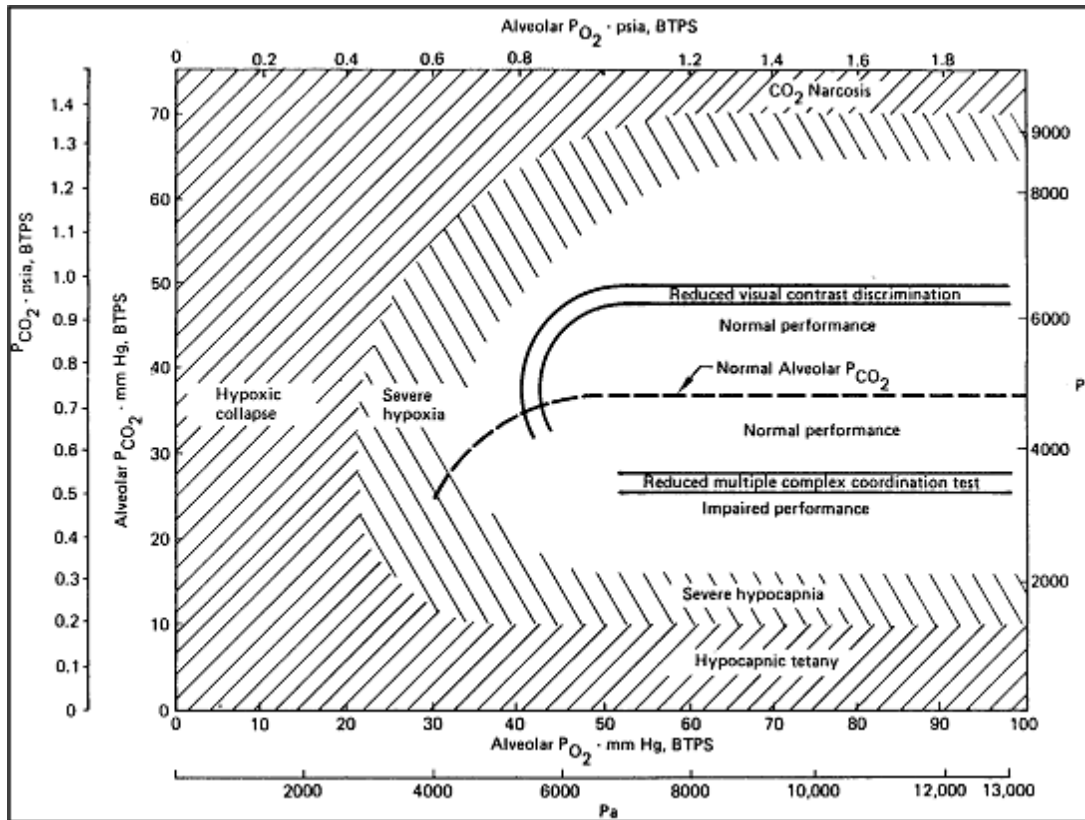


Figure 6.2-6. Relationship of alveolar O₂ and CO₂ composition to performance.

6.2.2.3.2 Carbon Dioxide Limits

CO₂ levels must be limited to the values in Table 6.2-6, which are defined in the Johnson Space Center (JSC) publication “Spacecraft Maximum Allowable Concentrations for Airborne Contaminants (SMAC)” (JSC 20584).

Table 6.2-6 Spacecraft Maximum Allowable Concentrations for CO₂

Time	Limit (mmHg)	Limit (psia)
1 h	15	0.29
24 h	9.9	0.19
7 to 180 d	5.3	0.10
1000 d	3.8	0.07

The SMACs are somewhat lower than limits for other Earth-based applications, which are shown in Table 6.2-7.

Table 6.2-7 Industrial and U.S. Navy Recommended Limits for CO₂

Source	Time	Limit (mmHg)	Limit (psia)
(Cable, 2004) – IDLH	Brief	30.4	0.59
(Cable, 2004) – STEL	15 min	22.8	0.44
NRC (2004) – EEGL	1 h	19.0	0.37
EEGL	24 h	19.0	0.37
CEGL	90 d	6.1	0.12
(Cable, 2004) – REL	Working lifetime	3.8	0.07
OSHA – PEL	Working lifetime	3.8	0.07
(Cable, 2004) – TLV	Working lifetime	3.8	0.07

ACGIH, American Conference of Governmental Industrial Hygienists; CEGL, continuous exposure guidance level; EEGL, emergency exposure guidance level; IDLH, immediately dangerous to life and health; NRC, National Research Council; PEL, permissible exposure limit; REL, recommended exposure limit; STEL, short-term exposure level; TLV, threshold limit value.

Crewmembers may be more sensitive to CO₂ or other atmospheric pollutants during space flight than they are on Earth. This may be associated with physiologic alterations induced by adaptation to microgravity, and thus limits may need to be set more conservatively than those used in terrestrial applications. The 1000-day CO₂ SMAC is based on anecdotal observations that above this level, sensitive persons experience subtle behavioral deterioration, perhaps due to mild headaches. Such behavioral issues are considered undesirable for shorter, near-Earth missions, but they cannot be accepted for long-duration exploration missions.

The rate of rise of CO₂, based on calculated respiration rates and the number of crewmembers on board, is slow and predictable. High levels of CO₂ are unlikely to be reached quickly unless an off-nominal event (e.g., fire) has occurred, which will be associated with other more toxic compounds being given off into the common atmosphere. Humans usually can adapt to slow elevation rates of CO₂ exposure, and therefore a reduction in the number and severity of symptoms may be observed. The SMAC values in Table 6.2-6 are time-weighted averages with the understanding that deviations more than 10% above the average are extremely rare and are fully compensated by periods during which the CO₂ levels are well below the limit. Spacecraft must be designed to minimize areas where CO₂ could accumulate; however, it is recognized that various operational activities may result in local CO₂ accumulations that elicit mild symptoms. If symptoms associated with CO₂ exposure do occur, then action must be taken to maintain better airflow in the suspect areas. If the level of CO₂ exceeds the SMAC levels listed in Table 6.2-6, then the risks of symptoms and/or performance decrements are considered unacceptable.

Carbon dioxide limits for the Constellation Program were based on the SMAC levels and the Russian “State Standard,” referred to as GOST (Table 6.2-8). These limits differ in that they provide a more descriptive time-weighted average based on multiple concentrations and location of sensors.

The time allowed by a local inspired air sensor differs from that allowed by the module sensors because CO₂ may accumulate in local regions of the spacecraft and there is an uncertain disparity

between what is being measured at the module sensor location vs. what the crewmember is actually breathing where he or she is located.

Module sensor values provide daily average concentrations. For ppCO₂, module sensors are intended to be more time-sensitive than a 24-hour time-weighted average; the sensor readings are available hourly or, in the worst case, every 8 hours.

Table 6.2-8 Constellation Program Partial Pressure CO₂ Limits for Crew Exposure

ppCO ₂ (kPa)	ppCO ₂ (mmHg) [1]	Time Allowed in Area Using Inspired ppCO ₂ [2]*	Time Allowed in Module Using Module Sensor**
NOMINAL [3]			
<i>0.0–0.67</i>	<i>0.0–5.0</i>	<i>indefinite</i>	<i>indefinite</i>
SUBOPTIMAL			
0.67–0.71	> 5.0–5.3	30 days	7 days
0.71–0.80	> 5.3–6.0	7 days	24 hours
0.80–1.01	> 6.0–7.6	24 hours	8 hours
1.01–1.33	> 7.6–10	8 hours	4 hours
OFF-NOMINAL AND EMERGENCY [4]			
1.33–2.00	> 10.0–15	4 hours	1 hour
2.00–2.67	> 15.0–20.0	2 hours	30 minutes
2.67–4.00	> 20.0–30.0	30 minutes	Do not exceed
4.00–5.33	> 30.0–40.0	Do not exceed	Do not exceed
5.33–10.1	> 40.0–76	Danger Zone	Danger Zone
>10.1	>76.0	Emergency	Emergency

NOTES:

1. Partial Pressure of CO₂ (Carbon Dioxide)
2. Partial Pressure of CO₂ (Carbon Dioxide as measured at the point of inspiration)
3. Nominal pressure ranges are included for completeness and denoted by italic font. HS3004C is the requirement for nominal ppCO₂.
4. Return ppCO₂ to nominal levels for a minimum of 8 hours to reset the time allowed at off-nominal levels. Without an 8-hour interval at nominal CO₂ levels, count all suboptimal and off-nominal exposure as cumulative.

*Area sensors are used to measure the ppCO₂ that a person in the area is inspiring.

**The module sensor may not be in the area where crewmembers are located at the time.

6.2.2.4 Diluent Gas

Earth’s atmosphere provides a physiologically inert gas, nitrogen, which comprises 78% of Earth’s air by volume, with a partial pressure of 594 mmHg (11.5 psi). The best candidate atmospheres for spacecrafts will likely use nitrogen, but could contain one or more of the following physiologically inert diluent gases: nitrogen, helium, neon, argon, krypton, or xenon. The diluent gas can serve several functions:

- It can be used to increase cabin total pressure without increasing ppO₂ and risk of O₂ toxicity and flammability.
- In the event that a closed pocket of gas occurs in the crewmember's body, the pocket may collapse. This may occur in the middle ear if the middle ear is not periodically ventilated (ear clearing). It can also occur in small segments of the lungs during high stress, since the oxygen and carbon dioxide present in the pocket are absorbed rapidly. A diluent gas added to the mixture will be absorbed more slowly, and will help prevent such a collapse, which is known as pulmonary alveolar atelectasis.
- Experiments, particularly in life sciences, may be sensitive to atmospheric parameters. A choice of Earth-normal atmosphere (i.e., 760 mmHg [14.7 psi] total pressure with 79% nitrogen, 21% oxygen, plus minor constituents) provides a less complicated laboratory test environment than pure oxygen. Normal atmosphere allows the use of standard laboratory equipment.
- Diluent gas(es) in the cabin atmosphere will act as a suppressant in case of fire.

A choice of atmospheric composition that contains a diluent gas other than nitrogen may have associated side effects for a spacecraft crew. The following sections discuss metabolic, thermal, and vocal factors that may affect crew performance.

6.2.2.4.1 Metabolic Factors

All gases considered for the role of diluent in a spacecraft atmosphere must be physiologically inert (i.e., the body must have relatively little metabolic response to the diluent under normal conditions).

6.2.2.4.2 Thermal Factors

With the exception of helium, the diluent gases considered for use in cabin atmospheres do not present difficulties with thermal regulation.

The thermal conductivity of helium is six times that of nitrogen. For this reason, experience has shown that air temperatures must be maintained at least 2°C to 3°C (36°F to 37°F) higher than normal for subjects at rest to remain in the thermal comfort zone.

6.2.2.4.3 Vocal Factors

The low density of helium-oxygen mixtures causes an increase in the frequencies of the human voice. In gas mixtures with a high percentage of helium, substantial problems with speech intelligibility may be encountered. In these circumstances, partial mixes with nitrogen or neon added to the heliox (helium-oxygen) mixture will be of benefit. Electronic processing has also been used to improve communication clarity.

6.2.2.4.4 Toxicity Factors

At higher pressures, diluent gases could exhibit toxic effects. The use of any diluent gas other than nitrogen for the spacecraft atmosphere would necessitate further research.

6.2.2.4.5 Decompression Sickness Factors

Each diluent gas will have different tissue saturation and washout rates. Using a diluent gas other than nitrogen for the spacecraft atmosphere would necessitate further research.

6.2.2.5 Internal Atmosphere Composition and Pressure Monitoring and Control

The crew must have the ability to monitor atmospheric parameters, including total pressure, ppO₂, ppCO₂, temperature, and humidity, to ensure the health of the spacecraft and prevent potential health threats to the crew. The crew must have the ability to review previous atmospheric data for analysis, such as trending. Various procedures, including opening and closing hatches, EVA prebreathe, and loss-of-pressure procedures, may also require knowledge of these values by the crew.

In addition to monitoring capability, alerting functions must exist to warn the crew when atmospheric parameters exceed high and low limits. Certain procedures (e.g., a loss-of-pressure emergency) will be initiated based on the values of major constituents in the spacecraft's atmosphere. Alerting removes the need for the crew to constantly monitor these atmospheric parameters during periods when there is no communication with the ground.

Although the spacecraft's environmental control system automatically controls atmospheric parameters to within safe limits, the crew must have the ability to control certain parameters including total pressure and ppO₂. For example, EVA prebreathe may require a drop in cabin pressure or change in ppO₂, and a contingency or damage to sensors may require the crew to manually control some parameters.

6.2.2.6 Mission-Related Effects on Internal Atmosphere Composition and Pressure

Various flight regimes may influence the choices a designer makes in selecting an atmosphere, and the following should be considered:

- Pre-launch – Contamination from ambient atmosphere during boarding may influence the pressurization or depressurization schedule. Low-pressure cabins may require an oxygen prebreathe.
- Launch – The possibility of oxygen atelectasis during high-g stress with a 100% O₂ atmosphere suggests that a diluent gas should be included in the mixture. The shallow breathing that may result from high-g loading may dictate a higher O₂ concentration or an increased ventilation rate.
- Short Flights – Greater ranges of atmospheric parameters (e.g., CO₂ partial pressure and pure O₂ atmospheres) may be tolerated on short flights as the detrimental effects of these are time-dependent.
- Long Flights – For longer flights, tolerance to irritating or toxic substances is reduced, and trace contaminants become more important and crew comfort of greater concern.
- Entry and Landing – During entry and landing, the same conditions exist as during launch. The consideration of ambient conditions is added if the landing is performed in an extraterrestrial environment.

- Post Landing – If on Earth, reintroducing ambient atmosphere on an appropriate schedule may be desirable while waiting for debarkation. If not on Earth, ambient conditions, EVA operations, experiments, etc., may influence atmospheric design.

6.2.3 Atmospheric Temperature, Humidity, and Ventilation

The combination of atmospheric temperature, humidity, and ventilation regulates thermal comfort by maintaining a careful balance of these parameters. A given temperature may be uncomfortable in the presence of high humidity and low ventilation, but acceptable with a small variation in one or all of the parameters.

6.2.3.1 Temperature

Maintaining proper atmospheric temperature is important for maintaining a safe body core temperature, and is also important for comfort. Humans can survive in a wide range of atmospheric temperatures for various amounts of time, but human comfort without use of thermal protective garments requires a fairly narrow temperature range. The Space Shuttle temperature could be controlled within the range of 18.0°C to 27.0°C (64.0°F to 81.0°F). The effects of direct contact with hot and cold items are discussed in section 9.12, “Safety Hazards.”

6.2.3.1.1 Heat

As temperature begins to rise, the body responds by increasing peripheral circulation, vasodilation, and sweating in an attempt to remove heat from the body. However, if heat cannot be removed fast enough, body core temperature rises, which results in discomfort as well as cognitive and physical impairment. Table 6.2-9 identifies core temperature range limits and associated performance decrements.

Table 6.2-9 Core Temperature Range Limits and Associated Performance Decrements

Core Temperature °C (°F)	Equivalent Heat Storage kilojoules (BTU)	Medical Condition
37.7–38.2 (99.9–100.8)	317–422 (300–400)	Onset of decrement in performance of cognitive tasks Decreasing manual dexterity Discomfort Hyperthermia (or heat stress)
38.2–39.2 (100.8– 102.6)	422–633 (400–600)	Slowed cognitive function Increased errors in judgment Loss of tracking skills 25% risk of heat casualties Possible heat exhaustion
39.2–39.6 (102.6– 103.3)	633–844 (600–800)	Functional limit of physical tasks 50% risk of heat casualties Probable heat exhaustion Possible heat stroke
>40 (>104)	>844 (>800)	100% risk of heat casualties Probable heat stroke

A spacecraft cabin with excess heat load may quickly reach crew tolerance limits and may impair crew performance and health. Crew impairment begins when skin temperature increases more than 1.4°C (2.5°F) or core temperature increases more than 0.6°C (1°F), or if pulse is greater than 140 bpm. Precise prediction of crew tolerances during Earth entry is not possible; therefore, environmental temperature must be controlled.

Excess heat storage can be mitigated with special cooling garments, such as the Liquid Cooling and Ventilation Garment used on the Space Shuttle.

6.2.3.1.2 Cold

In a cold-stress situation, the body will rapidly reduce peripheral circulation in an attempt to conserve core heat. As the core and skin temperatures continue to drop, shivering begins and discomfort is continually present. Eventually shivering may become violent and uncontrollable.

If the surface temperature of the hand falls below 12°C–14°C (54°F–57°F), manipulative ability begins to fail. As the hand temperature drops lower, more serious loss of manipulative ability occurs, partly from stiffness and partly from the loss of tactile sensitivity. The final decrement is caused by the loss of brain functioning due to a drop in core temperature. The brain loses the capacity for cognitive functions if its temperature drops much below 34°C–35°C (93°F–95°F) even though the body is still capable of responding to instruction.

As the core continues to lose heat, shivering eventually lessens, and then stops altogether. At this point, complete loss of thermoregulation is imminent. Death, however, may not come quickly. The core temperature can be drastically reduced, to 26°C (78.6°F) or lower, and the body can still survive. If the core experiences such extreme cooling, however, death can occur when attempts are made to re-warm the body, cardiac fibrillation being the common cause of death.

Excess heat rejection can be mitigated to some degree by the use of insulating garments. Figure 6.2-9 shows the effect on tolerance to cold temperature and wind of the addition of various degrees of thermal protective clothing.

6.2.3.1.3 Thermal Limits

The thermal conditions in the comfort zone in Figure 6.2-7 must be met throughout nominal mission phases. The comfort zone is defined as the range of environmental conditions in which humans can achieve thermal comfort and not have their performance of routine activities affected by thermal stress. Thermal comfort is affected by the work rate, clothing, and state of acclimatization.

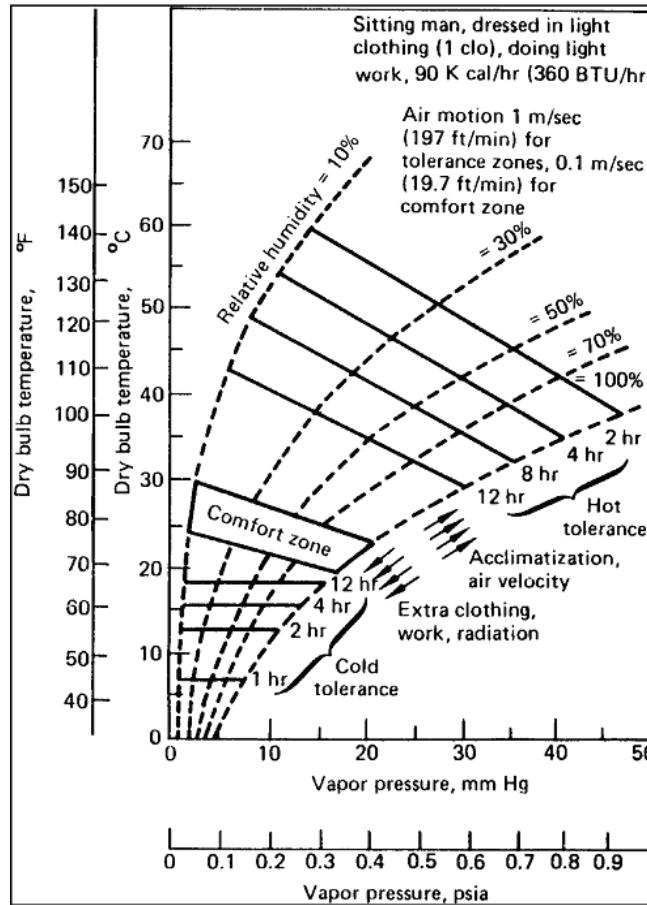


Figure 6.2-7. Environmental comfort zone.

The comfort zone does not include the entire range of conditions in which humans can survive indefinitely. The indefinite survival zone is larger and might require active perspiration or shivering, which are initiated by elevated or lowered core temperatures. Operation outside the comfort zone may be associated with performance decrements. The graph implies minimal air movement and assumes the radiant temperature of the surroundings to be equal to the dry bulb temperature. The effects of acclimatization, work, and heavier clothing are shown as data trends by the arrows on the graph. The temperature range that bounds the comfort zone is 18°C (64.4°F) to 27°C (80.6°F), has been used successfully for STS and ISS nominal spacecraft operations, and is recommended for future spacecraft.

For operations such as ascent, entry, suited operation, exercise, and off-nominal situations, brief temperature excursions may occur. Instead of defining absolute temperatures for excursions, body heat storage can be calculated. The thermal comfort objective is to maintain body thermal storage within the comfort zone defined by the following equation:

$$\Delta Q_{\text{stored}} = \frac{MR - 278}{13.2} \pm 65 \text{ BTU}$$

where MR = metabolic rate in BTU/h, and ΔQ_{stored} is the change in heat stored from the nominal quantity of heat stored in the human body at normal body temperature at rest. This calculation can be converted to BTU/lb by dividing the ΔQ_{stored} (BTU) by 154 lb (the legacy standard man weight). This number can be further converted to kJ/kg using the conversion factors of 1 BTU = 1055.056 J and 1 lb = 0.4535924 kg.

The accepted means of calculating heat storage or rejection (Q_{stored}) is to use the 41-Node Man or Wissler model. The 41-Node Man model has been used and incorporated into NASA testing, tests since the 1960s have shown it to be accurate within 5%.

During those portions of a mission when cabin conditions cannot be maintained within nominal limits, short periods of departure from the comfort zone can be accommodated by crewmembers through heat storage or rejection, but must not exceed the cognitive deficit onset limits, defined by the range:

$$4.7 \text{ kJ/kg (2.0 BTU/lb)} > \Delta Q_{stored} > -4.1 \text{ kJ/kg (-1.8 BTU/lb)}$$

Outside this range, impairment of cognitive performance occurs. Beyond the cognitive impairment zone is the tolerance zone, where there is a loss of physical skills (tracking) and a possibility of injury. The limits for retention of physical skills are defined by the following range:

$$6.0 \text{ kJ/kg (2.6 BTU/lb)} > \Delta Q_{stored} > -6.0 \text{ kJ/kg (-2.6 BTU/lb)}$$

Figure 6.2-8 shows the ΔQ_{stored} zones for comfort, performance impairment, and tolerance. The vertical axis is the change in body heat storage. The tolerance zone ranges from -6.0 kJ/kg (for physical cold injury risk greater than 50%) to $+6.0$ kJ/kg (for physical heat injury risk greater than 50%). The cognitive performance impairment zone ranges from -4.1 kJ/kg (for cold) to $+6.0$ kJ/kg (for heat). The figure also shows a plot of the comfort zone as a function of metabolic rate. For example, a crewmember with a metabolic rate of 1,705 BTU/h will be in the middle of the comfort zone at approximately 1.6 kJ/kg (0.7 BTU/lb) of stored body heat above normal resting storage.

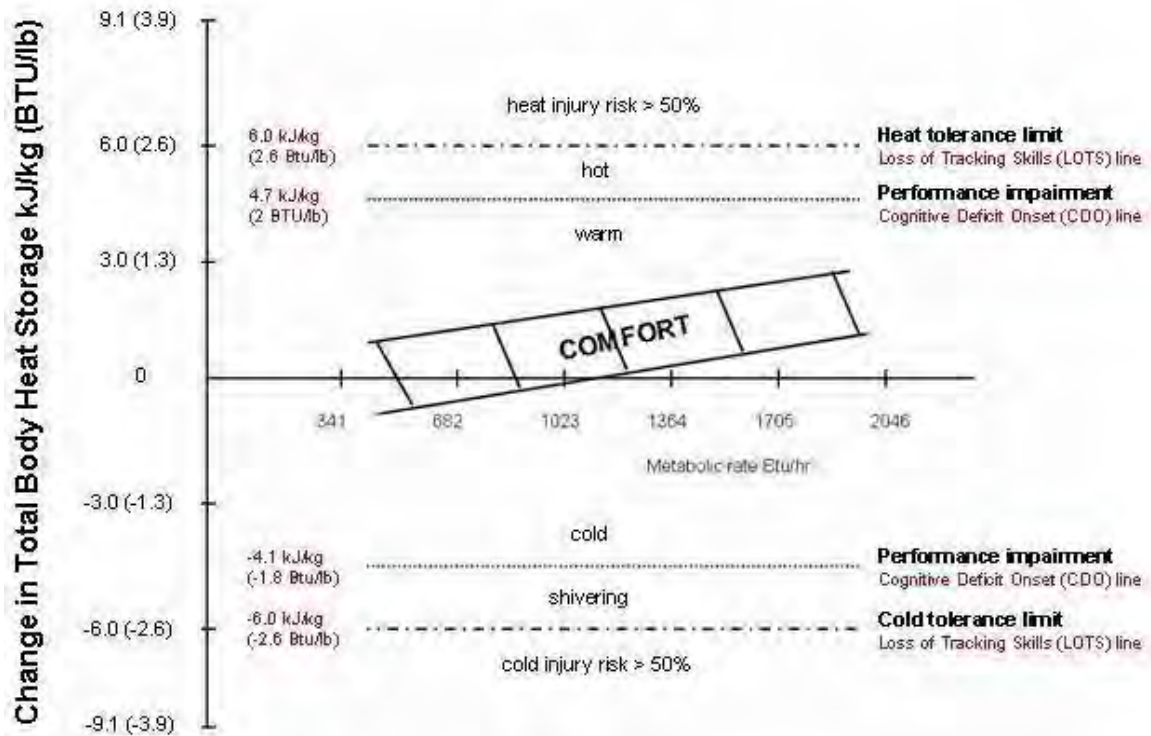


Figure 6.2-8. Heat storage zones for comfort, performance impairment, and tolerance.

Keeping the crewmember heat storage value below the performance impairment line allows the crew to conduct complex tasks without heat-induced degradation. In a non-acclimatized individual, water loss is approximately 0.95 L (32 oz) per hour and salt loss is approximately 2 to 3 grams (0.004 to 0.007 lb) per hour. In microgravity and elevated humidity, sweat forms an insulating layer over the body, further adding to the heat stress instead of relieving it. If the crewmember is in a suit, the heat load may increase rapidly. JSC thermoregulatory models (Wissler and 41-Node Man) simulating entry of a hot cabin by crewmembers wearing launch and entry suits with the properties (thickness, conductance, wickability, emissivity) of the Advanced Crew Escape Suit (ACES) predicted loss of all body cooling mechanisms. Supporting data from military aircrew protective ensembles suggests that body temperature may increase more rapidly over time in the ACES than in a shirtsleeve environment.

Keeping the crewmember heat rejection value above the performance impairment level in Figure 6.2-8 allows the crew to conduct tasks without cold-induced degradation, which occurs at approximately -280 kJ (-265 BTU).

In summary, the thermal comfort objectives are:

- 1) Body thermal storage maintained within the comfort zone
- 2) Evaporative heat losses limited to insensible evaporation of moisture produced only by respiration and diffusion through the skin without active sweating
- 3) No thermogenic shivering
- 4) Body core temperatures maintained near the normal resting values of approximately 37°C (98°F)

- 5) Skin temperatures maintained near normal resting values of approximately 32.8°C to 34.4°C (91°F to 94°F) when no liquid cooling garments are used. During their use, skin temperatures will be significantly lower.

6.2.3.1.4 Expected Metabolic Loads

To allow calculation of spacecraft environmental control system capacity, it is necessary to know expected crewmember metabolic loads, which will be affected by the magnitude of work being performed. Tables 6.2-10 and 6.2-11 provide estimates of metabolically generated heat (column 5), water vapor (column 6), and CO₂ (column 9). These tables were populated with physiologically measured variables as well as 41-Node Man simulations. These are expected crew-induced loads based on the assumptions and conditions stated in the legend, and therefore will be altered if any of these variables change.

The data represent crew-induced loads from a single crewmember. In addition to any spacecraft- and equipment-induced loads, the spacecraft must accommodate crew-induced loads for the entire crew. Each crewmember must be able to exercise at the level represented by table 6.2-10 at least once per day.

Total heat output from a single crewmember is the sum of sensible (dry) heat and wet heat outputs. The sensible (dry) heat component includes only direct radiation and convection of heat from a crewmember. Total wet heat has two components: 1) latent heat, including heat in water vapor that is exhaled and water vapor that evaporates directly from the skin, and 2) heat in sweat runoff, which leaves the body as liquid sweat.

For purposes of spacecraft design modeling, O₂ consumption and CO₂ output are considered to be at the 75% VO₂max level during exercise, and return to nominal values when exercise has stopped. Water, O₂, and CO₂ are reported as kilograms and pounds mass, with O₂ and CO₂ converted from standard temperature and pressure, dry (STPD) data. The table data assumes the following:

- An 82-kg (181-lb) crewmember
- A 30-minute exercise period
- VO₂max = 45 mL/kg/min (1.25 in³/lb/min) at STPD
- 5% work efficiency of the exercise device
- Air and wall temperature = 21°C (70°F)
- Airflow = 9.1 m/min (30 ft/min)
- Dew point = 10°C (50°F)
- Spacecraft pressure = 70.3 kPa (10.2 psia)
- Microgravity loading
- Respiratory quotient = 0.92 (applied volumetrically)
- Crewmember wearing shorts and T-shirt
- Sleeping metabolic rate of 300 BTU/h
- Nominal metabolic rate of 474 BTU/h

- A metabolic rate of 500 BTU/h for the hour immediately after exercise completion

The variability of this analysis is 5%. If any of the above conditions or assumptions changes, the described loads will be altered.

Table 6.2-10 Crew-Induced Metabolic Loads for a Standard Mission Day with Exercise

1	2	3	4	5	6	7	8	9
Crew Member Activity Description	Duration of Activity (hr)	Sensible (dry) Heat Output kJ/hr (btu/hr)	Wet Heat Output (includes latent and sweat runoff) kJ/hr (btu/hr)	Total Heat Output Rate kJ/hr (btu/hr) ⁽²⁾	Water Vapor Output kg/min* 10 ⁻⁴ (lbm/min* 10 ⁻⁴)	Sweat Runoff Rate kg/min* 10 ⁻⁴ (lbm/min* 10 ⁻⁴)	O ₂ Consumption ⁽⁴⁾ kg/min* 10 ⁻⁴ (lbm/min* 10 ⁻⁴)	CO ₂ Output ⁽⁴⁾ kg/min* 10 ⁻⁴ (lbm/min* 10 ⁻⁴)
Sleep	8	224 (213)	92 (87)	317 (300)	6.30 (13.90)	0.00 (0.00) ⁽¹⁾	3.60 (7.94)	4.55 (10.03)
Nominal	14.5	329 (312)	171 (162)	500 (474)	11.77 (25.95)	0.00 (0.00) ⁽¹⁾	5.68 (12.55)	7.20 (15.87)
Exercise 0 - 15 min at 75% VO ₂ max	0.25	514 (487)	692 (656)	1206 (1143)	46.16 (101.76)	1.56 (3.43)	39.40 (86.86)	49.85 (109.90)
Exercise 15 - 30 min at 75% VO ₂ max	0.25	624 (591)	2351 (2228)	2974 (2819)	128.42 (283.13)	33.52 (73.90)	39.40 (86.86)	49.85 (109.90)
Recovery 0 - 15 min post 75% VO ₂ max	0.25	568 (538)	1437 (1362)	2005 (1900)	83.83 (184.82)	15.16 (33.43)	5.68 (12.55)	7.2 (15.86)
Recovery 15 - 30 min post 75% VO ₂ max	0.25	488 (463)	589 (559)	1078 (1022)	40.29 (88.82)	0.36 (0.79)	5.68 (12.55)	7.2 (15.86)
Recovery 30 - 45 min post 75% VO ₂ max	0.25	466 (442)	399 (378)	865 (820)	27.44 (60.50)	0.00 (0.00) ⁽¹⁾	5.68 (12.55)	7.2 (15.86)
Recovery 45 - 60 min post 75% VO ₂ max	0.25	455 (431)	296 (281)	751 (712)	20.40 (44.98)	0.00 (0.00) ⁽¹⁾	5.68 (12.55)	7.2 (15.86)
Total Per Day⁽³⁾	24	7351 (6967)	4649 (4410)	12000 (11377)	1.85 (4.07)	0.08 (0.17)	0.82 (1.80)	1.04 (2.29)

Footnotes are explained below Table 6.2-11.

Table 6.2-11 Crew-Induced Metabolic Loads for a Standard Mission Day, No Exercise

Crew Member Activity Description	Duration of Activity (hr)	Sensible (dry) Heat Output kJ/hr (btu/hr)	Wet Heat Output (includes latent and sweat runoff) kJ/hr (btu/hr)	Total Heat Output Rate kJ/hr (btu/hr) ⁽²⁾	Water Vapor Output kg/min* 10 ⁻⁴ (lbm/min* 10 ⁻⁴)	Sweat Runoff Rate kg/min* 10 ⁻⁴ (lbm/min* 10 ⁻⁴)	O ₂ Consumption ⁽⁴⁾ kg/min* 10 ⁻⁴ (lbm/min* 10 ⁻⁴)	CO ₂ Output ⁽⁴⁾ kg/min* 10 ⁻⁴ (lbm/min* 10 ⁻⁴)
Sleep	8	224 (213)	92 (87) ⁽¹⁾	317 (300)	6.30 (13.90)	0.00 (0.00) ⁽¹⁾	3.60 (7.94)	4.55 (10.03)
Nominal	16	329 (312)	171 (162) ⁽¹⁾	500 (474)	11.77 (25.95)	0.00 (0.00) ⁽¹⁾	5.68 (12.55)	7.20 (15.87)
Total Per Day⁽³⁾	24	7056 (6696)	3472 (3288)	10536 (9984)	1.43 (3.16)	0.00 (0.00)⁽¹⁾	0.72 (1.59)	0.91 (2.00)

* lbm, pound mass.

(1) These values do not include a sweat runoff component, as none is expected.

(2) This column reflects a lag between metabolic rate and heat output.

(3) No multipliers are applied to the Totals row.

(4) A respiratory quotient of 0.92 was assumed for the oxygen consumption and carbon dioxide output determinations.

6.2.3.2 Relative Humidity

Average relative humidity must be maintained between 25% and 75% over each 24-hour period during all mission operations, excluding suited operations of less than 4 hours and post landing. Ideally, average relative humidity should be maintained between 30% and 50% over each 24-hour period during all mission operations. For suited operations less than 4 hours and during nominal post-landing activities, humidity must be limited to the levels in Table 6.2-12. Note that the nominal range (>30% – 50%) is the preferred range for crew comfort and the tolerable range ensures crew health, but may be outside of some crewmembers' comfort zones.

Table 6.2-12 Relative Humidity Exposure Times

Average Relative Humidity	Time Allowed
≤5%	1 hour
>5% – 15%	2 hours
>15 – 25%	4 hours
>30% – 50% (nominal range) >25% – 75% (tolerable range)	Indefinite*
>75% – 85%	24 hours**
>85% – 95%	12 hours**
>95%	8 hours**

Nominal humidity range is included for completeness.

*Assumes temperature is within nominal range.

**Only after doffing a suit post landing; duration may be shorter if temperature is outside nominal range.

Relative humidity is the amount of water vapor in the atmosphere relative to the maximum amount of water vapor the atmosphere can hold at a given temperature. Low humidity causes drying of the eyes, skin, and mucous membranes of the nose and throat, which can lead to an increased incidence of respiratory infections (Carleon, 1971). High relative humidity can result in condensation on surfaces, which can be conducive to microbial and fungal growth. Water vapor pressure of 0.19 psi (10 mmHg) is optimal for habitability. The Shuttle's environmental control system controlled water vapor pressure between 0.12 and 0.27 psi (6 and 14 mmHg). Variations in humidity have little effect on comfort if a good heat balance is maintained, but becomes significant at the upper range of comfortable temperatures.

6.2.3.3 Ventilation

Crew and equipment give off heat, moisture, and CO₂ that will lead to cabin parameters being outside the bounds of environmental requirements if adequate ventilation is not provided. This is especially likely in microgravity, where natural convection is not present. Maintaining proper ventilation within the internal atmosphere is necessary to ensure that stagnant pockets do not form, and the temperature, humidity, and atmospheric constituents are maintained within their appropriate ranges.

For microgravity operations, the nominal ventilation rate in the internal atmosphere must be such that two-thirds (66.7%) of the atmosphere velocities are between 4.57 m/min (15 ft/min) and 36.58 m/min (120 ft/min). Similar values have been used on the ISS. The two-thirds value for atmosphere velocities has historically proven to be a reasonable balance within design constraints such as power, acoustics, and safety. The effective atmosphere velocity range of 4.57 to 36.58 m/min (15 to 120 ft/min) pertains to the time-averaged velocity magnitudes in the crew-occupied space, using averages over periods long enough to achieve stability. This range is considered to provide circulation that prevents CO₂ and thermal pockets from forming. Cabin ventilation is not needed during suited operation since the suit will provide necessary air circulation. Sometimes, such as during a fire or other release of toxic substances into the atmosphere, the mentioned ventilation rates are not in the best interest of air quality and crew health. In those cases, the ventilation system may need to be shut down to protect the safety of the crew.

Below are special considerations for design of the ventilation system. (Details for the design of specific ventilation areas within the living environment can be found in Chapter 7, “Habitability Functions”).

- Exercise station – The exercise area should be provided with an increase in airflow to facilitate heat transfer and to relieve sweat accumulation. Individual airflow units with air temperature control will help the crewmember match the airflow to the activity. The direction of airflow should not blow sweat into other station areas, particularly eating or sleeping stations, and air should blow over the entire body, not just one part (Chapter 7.5).
- Sleeping station – Individually adjustable airflow controls should be considered (Chapter 7.10).
- Eating station – Airflow should not blow loose morsels of food away from crewmembers.
- Ventilator intakes – Ventilation system inlets should be accessible to crewmembers for recovery of lost objects. Airflow in the vicinity of the inlets should not exceed 0.2 m/s (40 ft/min) (Chapter 6.2).
- Maintenance areas – Crewmembers may be required to perform maintenance behind a panel in an area that is not part of the normal habitable volume and therefore does not have ventilation. Local ppO₂, ppCO₂, and relative humidity must be controlled for temporary maintenance activities in areas not in the normal habitable volume. This is necessary to ensure that stagnant pockets do not form, and that temperature, humidity, and atmospheric constituents are maintained within their appropriate ranges. Historical examples of ventilation techniques include equipment such as flexible (reconfigurable) ducting, portable fans, and diverters.

6.2.3.4 Temperature, Humidity, and Ventilation Monitoring and Control

Atmospheric parameters, including humidity, temperature, and ventilation, must be controlled automatically with the capability for crew override.

A monitoring and recording capability must be provided to continuously quantify gross atmospheric parameters, including humidity and temperature, and provide automatic feedback to the system when these need to be corrected to ensure crew health and comfort. This atmospheric parameter data from each isolatable compartment (e.g., airlock) must be available to the crew.

6.2.3.4.1 Temperature

- Temperature Displays – The system must display temperature with a display step size of no greater than 1°C (1.8°F).
- Temperature Adjustment Increments – To provide adequate adjustability for crew comfort, the system must provide and display temperature set points in increments of no greater than 1°C (1.8°F).
- Temperature Adjustment Ranges – The system must allow crewmembers to adjust the atmospheric temperature between 21°C (70°F) and 27°C (81°F), inclusive, to account for individual comfort preferences and workload variations.
- Temperature Set Point Error – The temperature must be controlled to within $\pm 1.5^\circ\text{C}$ (2.7°F) of the set point of the operational temperatures. This precision is sufficient to maintain crew comfort.
- Temperature Adjustment Accessibility – Temperature set point control must be accessible to at least one crewmember during all nominal operations, including times when the crew is restrained (such as before launch and during entry).
- Temperature Recording – Temperature data must be recorded, to allow the crew and ground to analyze the data in real time to understand trends and help to prevent temperature excursions beyond acceptable limits.

6.2.3.4.2 Relative Humidity

Humidity data must be displayed and recorded. Recording is necessary to allow the crew and ground to analyze the data in real time to understand trends and help to prevent humidity excursions beyond acceptable limits.

6.2.3.4.3 Ventilation

The crew must be able to control and adjust the ventilation rate and direction for some outlets within the vehicle, specifically in areas where the crew is in confined spaces with limited mobility. The ability to control local cabin ventilation by adjusting the direction of airflow will enable the crew to prevent exhaled, CO₂-rich air from building up around the head (i.e., adjust for too little ventilation), and to prevent drying of facial mucous membranes (i.e., adjust for too much ventilation).

6.2.4 Atmosphere Contamination

The spacecraft atmosphere must not be contaminated with substances that can be harmful to the crew. The following are contaminants to be considered for prevention, monitoring, and protection:

- Biological
 - Fungi
 - Bacteria
- Particulates (including lunar dust)
- Toxic substances (including those produced by combustion events)

To alert the crew to the presence of contaminants, or to ensure that cleanup activities have been successful, the capability must exist to detect contaminants that pose a plausible risk to crew health.

While spacecraft and system design needs to minimize the existence of contaminants in the atmosphere, damage to fluid lines, loss of containment in payloads and systems, use of utility compounds, entry of propellants after an EVA, and fire can introduce contaminants into the cabin. The ability to detect contaminants is necessary to ensure crew safety.

Monitoring must be both targeted at potential threats to the atmosphere (such as fires, toxin release, and system leaks) and broad-spectrum to alert the crew to less predictable risks to air quality.

To ensure safety, the following functions must be provided:

- Alerting the crew to anomalies
- Providing sufficient time for effective corrective action
- Providing sufficient information for timely corrective action (including trend data, if necessary)

Personal protective equipment (PPE) must be provided to protect the crew from exposure to contaminants, such as liquid spills, gaseous leaks, and smoke. The PPE required depends on the type of contamination. Exposure to a minimally toxic contaminant (sodium chloride, an eye irritant) may require only the donning of protective goggles and nitrile gloves and the use of wipes to clean up. However, should the crew be exposed to a more toxic contaminant, such as acetonitrile, the response would require goggles and chemical-resistant gloves to protect the crew. The use of chemical-resistant bags and cleanup mitts may also be required for cleaning up the contamination. On the ISS, the Crew Contamination Protection Kit (CCPK) provides the crew with the necessary items to respond to most contamination scenarios. The CCPK contains goggles for eye protection, masks for respiratory protection, gloves for skin protection, waste bags for containment, decals for labeling the containment bags, and the Space Station Eyewash (see Figure 6.2-9), which allows a continuous flow of water to flush contaminants out of the eyes. The PPE contained in the CCPK does not provide adequate protection for highly volatile substances such as ammonia, and to avoid exposure to such substances, evacuation from the contaminated module is required.



Figure 6.2-9. Space Station Eyewash.

6.2.4.1 Biological

Microbial contamination must be limited to the values in Table 6.2-13.

Table 6.2-13 Microbial Contaminant Levels

Contaminant	Limit
Fungus	Below 100 colony-forming units/m ³ with a crew-generated rate of 1,640 CFU/person-minute.
Bacteria	Below 1000 colony-forming units/m ³ with a crew-generated rate of 1,640 CFU/person-minute.

CFU, colony-forming units.

Although humans are continually exposed to a wide variety of microorganisms, only a small fraction of them actually cause disease in a healthy population. In fact, disease is a rare consequence of infection. Usually the presence and even multiplication of microorganisms on or within the host does not result in clinical disease. However, some bacteria, fungi, viruses, and protozoa can cause infectious diseases and allergic reactions, and reasonable precautions must be taken to prevent or limit the clinical impact during a space mission.

While microorganisms can also be responsible for other adverse effects, including material degradation and toxin and allergen production, the primary purpose of microbiological assessments of spacecraft is the mitigation of crew illness, impairment, or death due to infectious disease during a mission. In this section, infectious disease includes all adverse effects associated with human exposure to microbial agents, including toxin and allergen exposure. The risk of infectious disease during space missions is composed of several factors, including (a) the

crewmembers' susceptibility, (b) the crewmembers' exposure to the infectious disease agent, (c) the concentration of the infectious agent, and (d) the characteristics of the infectious agent.

Microbial action on airborne compounds can also cause toxicity concerns. During STS-55, the storage of waste in contingency waste containers allowed the microbes inside to produce several kinds of alkyl sulfides, which are extremely noxious compounds. These compounds were able to escape into the cabin because the bags were permeable to these small, volatile compounds. In another lesson, it was discovered that residual ethylene glycol that could not be easily cleaned up was an adequate substrate for microbial growth. In the process of growing, the microbes oxidized the glycol to organic compounds that were much more toxic to skin than the glycol. Therefore, it is important that the spacecraft be kept free of accumulations of anything that microbes can use as a substrate.

The ability to monitor, identify, and characterize the microbial flora of the space module is essential because of continual habitation, relatively crowded conditions, and possible altered host-microorganism interactions. The following three factors are of particular importance when attempting to monitor, measure, and control microbiological contaminants:

- Traditionally, an Environmental Control and Life Support System (ECLSS) can usually maintain air quality through good ventilation and filtration practices, though remediation after a contamination event can be limited due to design constraints.
- The unique properties of microgravity affect the distribution of microbial agents in the space module environment. On Earth, gravity is an important physical force in reducing the presence of aerosols in the air and thus helps contain the spread of some infectious diseases. Whereas large particles and droplets containing microorganisms are removed from the air in minutes in a 1g environment, these aerosols may remain suspended indefinitely in microgravity.
- The immunological status of crewmembers may be compromised by physiological effects associated with stress and long periods of habitation in a microgravity environment.

By far, the most important strategy in mitigating microbial risk has been found to be prevention, which includes a variety of spacecraft design and operational methods to prevent accumulation and transfer of microorganisms. Limiting crew exposure during a mission minimizes the chance of a crewmember encountering medically significant organisms at an infectious dose.

Recirculated cabin air should be filtered through devices that provide high-efficiency removal of particles. Most of these controls are not unique to space missions and are common in terrestrial use, such as the use of high-efficiency particulate air (HEPA) filters in air systems. When filtration is combined with operational controls during flight, the spread of microbial contamination should be minimized even during extended-duration missions. The use of a microbial air filter on board the ISS has decreased microbial concentrations in the breathable air to very low levels. Specifically, the ISS air system incorporated a HEPA filter that is designed to remove at least 99.97% of airborne particles $\geq 0.3 \mu\text{m}$ in diameter per pass. The use of this engineering solution has decreased the need for in-flight microbial monitoring.

Historically, microbial air quality has been monitored using air impaction devices that draw the air onto a base plate containing culture medium. After incubation, the microorganisms that have grown can be counted and identified. Monitoring frequency depends on the type of system and the duration of the mission. Short missions, as seen during the Space Shuttle Program, did not require monitoring. Longer habitation where the environment can substantially change, as seen

during the ISS Program, requires the capability for air monitoring. The frequency of sampling varies. Initially, sampling is more frequent, to ensure the ECLSS is performing as designed. On the ISS, this frequency is every 3 months. As the system demonstrates an ability to perform, the time between sampling sessions can be extended, possibly to the point where sampling is required only during a potential contamination event.

6.2.4.2 Particulates

The concentration of particulate matter less than 10 μm in aerodynamic diameter in the cabin atmosphere must be less than 1 mg/m^3 .

These limits are based on OSHA standards. Particulates have many sources on Earth, including sloughed skin cells and hair, dirt, dust, food, and lint. On Earth, these particulates generally settle to the floor or other horizontal surfaces, keeping them out of the atmosphere and making them easy to remove. In microgravity, particulates do not settle out, and tend to remain in the atmosphere until they are filtered in the atmosphere revitalization system. Inhalation of particulates can cause irritation of the respiratory system, and contact with them can cause irritation of the eyes.

Apollo crewmembers reported irritation from lunar dust, which was brought into the spacecraft as soil on the EVA suits. Although the 1/6g environment on the Moon generally kept the dust on the floor, as soon as microgravity was achieved in lunar orbit, the dust became airborne and began affecting crewmembers. Additional research is needed to understand the effects of lunar dust on humans, but it is currently understood that atmospheric contamination by lunar dust must be minimized. It is recommended that lunar dust contaminant of less than 10 μm aerodynamic diameter and equal to or greater than 0.1 μm (TBR) in the internal atmosphere be limited to a concentration below 0.05 mg/m^3 . This limit is a 180-day (6 months of episodic exposures) limit and is based on the minimum currently expected permissible limit, as estimated by the Lunar Airborne Dust Toxicity Advisory Group.

Monitoring of ordinary particulates is not a routine necessity as long as HEPA filters are operating and air circulation ensures that particulate material is delivered to the filter beds. However, if the particles have reactive surfaces (e.g., fresh lunar dust) and the crew could receive significant exposures before the particle surfaces are passivated, then monitoring may be required.

The recirculation of cabin air through filters, such as HEPA filters, can remove not only microbial contaminants but also nonmicrobial particles of very small size. Larger particulates must be removed by vacuum cleaners, similar to those used on the Shuttle and ISS.

6.2.4.3 Toxic Substances

Safe levels of air pollutants are established specifically for human-rated spacecraft by the JSC Toxicology Group in cooperation with a subcommittee of the National Research Council (NRC) Committee on Toxicology. The "Spacecraft Maximum Allowable Concentrations for Airborne Contaminants" (JSC 20584) defines the limits for toxic compounds, and they must not be exceeded.

Design considerations and analyses that have been used previously to achieve the SMACs are outlined in NASA/TP-1998-207978 (1998), "Elements of Spacecraft Cabin Air Quality Design."

Historical methods to achieve these values include a combination of air scrubbing, materials control (e.g., using NASA-STD-6001), and containment of system chemicals.

Separately from SMACs, materials that could suddenly pollute the atmosphere are reviewed for the toxic hazard posed to the crew. The categories of hazard levels are summarized in Table 6.2-14. The habitable volume must contain only chemicals that are hazard level 3 or below.

Chemicals that are hazard level 4 must be prevented from entering the habitable volume. These levels depend on the inherent toxicity of the material, the amount of material that could be released into the atmosphere, the volume into which the release could occur, the nature of the injury (contact or systemic), and the means available to clean up the release. For example, large volumes of relatively nontoxic material such as ammonia can be toxic hazard level 4, whereas small volumes of extremely hazardous materials such as thionyl chloride (from some types of batteries) can also be toxic hazard level 4.

Table 6.2-14 Criteria for Assignment of Toxicological Hazard Levels (JSC 26895, 1997)

Hazard Level	Irritancy	Systemic Effects	Containability and Decontamination
0 (Nonhazard)	Slight irritation that lasts < 30 min and will not require therapy.	None	Gas, solid, or liquid may or may not be containable.
1 (Critical)	Slight to moderate irritation that lasts > 30 min and will require therapy.	Minimal effects, no potential for lasting internal tissue damage.	Gas, solid, or liquid may or may not be containable. However, the crew will be protected from liquids and solids by surgical masks, gloves, and goggles.
2 (Catastrophic)	Moderate to severe irritation that has the potential for long-term performance decrement and will require therapy. Eye hazards: May cause permanent damage.	None	A solid or nonvolatile liquid. Can be contained by a cleanup procedure and disposed of. The crew will be protected by 5- μ m surgical masks, gloves, and goggles.

Hazard Level	Irritancy	Systemic Effects	Containability and Decontamination
3 (Catastrophic)	Irritancy alone does not constitute a level 3 hazard.	Appreciable effects on coordination, perception, memory, etc., or has the potential for long-term (delayed) serious injury (e.g., cancer), or may result in internal tissue damage.	A solid or nonvolatile liquid that can be contained by a cleanup crew and disposed of. Surgical masks and gloves will not protect the crew. Either quick-don masks or an emergency breathing system and gloves are required.
4 (Catastrophic)	Moderate to severe irritancy that has the potential for long-term crew performance decrement (for eye-only hazards, there may be a risk of permanent eye damage.) Note: Will require therapy if crew is exposed.	Appreciable effects on coordination, perception, memory, etc., or the potential for long-term (delayed) serious injury (e.g., cancer), or may result in internal tissue damage.	Gas, volatile liquid, or fumes that are not containable. The atmosphere revitalization system will be used to decontaminate. Either quick-don masks are required, or the contaminated module will be evacuated.

Human space flight has involved numerous toxicological events that have ranged in severity from trivial to life-threatening. Experience has shown that the typical frequency of such events during operation of a single spacecraft is as follows: potentially catastrophic event, once per decade; critical event, once per year; and trivial event, several times per year. Potentially catastrophic events have included the entry of propellants into the Apollo capsule (1975), the solid fuel oxygen generator (SFOG) fire aboard *Mir* (1997), the trace contaminant “fire” aboard *Mir* (1998), and the metal oxide (Metox) CO₂ absorption canister regeneration that released noxious fumes aboard the ISS (2003). Critical events have included any number of small electronics pyrolysis events, system leaks of ethylene glycol aboard *Mir*, and microbial release of noxious gases aboard STS-55. Trivial events typically center on unexpected smells detected by the crew.

In addition to monitoring for expected toxic substances, monitoring for unexpected toxic substances must be possible also. A broad-spectrum analyzer for air pollutants is a valuable tool in managing unexpected events, and should be considered. Because Metox CO₂ absorption canisters were inadvertently stored in the oven on the ISS for 6 months, pollutants accumulated in the canisters’ charcoal beds. When crewmembers attempted to regenerate the canisters by heating them, the pollutants were rapidly discharged, and the crew reported a noxious odor. They took refuge in the Russian segment and allowed 30 hours for the ECLSS to scrub the pollutants from the air, since no onboard means was available to assess the toxicity of the atmosphere. During a later nominal regeneration, the Volatile Organics Analyzer was used to show that the increased pollution from a nominal regeneration was minor.

6.2.4.3.1 Derived Toxic Substances

Spacecraft must be designed using only chemicals that, if they may be released into the habitable volume, do not decompose into hazardous compounds that threaten crew health during any phase of operations.

A few compounds have been shown to decompose into hazardous compounds during nominal atmosphere revitalization system operations on the Space Shuttle, and could present a toxic threat if the amount of the compound involved is sufficient and the product compound is hazardous. Halon is an example of such a chemical; if it is sufficiently heated during its normal use as a fire suppressant, it breaks down into highly toxic gaseous compounds; however, this requires an extremely hot fire, such as the SFOG fire aboard *Mir*. ECLSS experts determine whether a compound at risk for release into the atmosphere poses a threat to the system or could be converted to a more toxic compound by the environmental control system. Plausible off-nominal operations of the ECLSS should be considered. For example, off-temperature operation of an ECLSS during a NASA ground-based test in 1963 caused the conversion of trichloroethylene to dichloroacetylene. The latter is an extremely toxic compound that quickly affected crew health and caused termination of the test.

6.2.4.3.2 Fluid Systems

Fluid systems must use non-toxic fluids, to eliminate concerns of contamination due to leaks.

Persistent leaks of ethylene glycol, which is not especially toxic, aboard *Mir* caused some eye and respiratory irritation to the crew. On the ISS, ethylene glycol was replaced by Triol, which is much less toxic, as the heat-exchange fluid. Similar considerations are recommended for other fluids, such as ammonia.

6.2.4.3.3 Combustion Events

The crew must be able to monitor the concentrations of combustion-derived products to determine the correct course of action after a combustion event to mitigate risk to crew health. Monitoring systems must provide a real-time capability for the measurement and display of atmospheric concentrations of toxic combustion products in the following ranges:

- Carbon monoxide (CO) from 5 to 500 ppm
- Hydrogen cyanide (HCN) from 1 to 50 ppm
- Hydrogen chloride (HCl) from 1 to 50 ppm

In addition, the crew must be alerted when CO concentrations exceed 5 ppm.

Fire, and the resulting smoke, is one of the most difficult hazards to cope with in the space environment. From the first statement of mission concept, the interactions between fire hazards and spacecraft configuration need to be analyzed. Besides injury due to fire itself, a secondary hazard of fires is the inhalation of toxic combustion products such as CO, HCN, and hydrochloric acid (HCl). During and after a fire event, combustion products can present an

immediate threat to the life of the crew because of the limited escape options, the fragility of the atmosphere, and the crew's immediate need for safe air.

The Compound Specific Analyzer – Combustion Products, which is flown on the ISS, measures CO, HCN, and HCl. The *Mir* SFOG fire showed that a large, hot, oxygen-rich fire does not necessarily produce many toxic products. The trace contaminant control fire on *Mir* showed that CO, which can be generated in large quantities from a small fire, can cause serious, insidious effects on crew health. Lesser fires have shown that the crew needs immediate assurance of the limited threat to their health when they smell combustion products. This requires a carefully planned monitoring strategy, which includes volatile gases as well as smoke.

6.2.4.3.3.1 Fire Prevention

While the potential for fire in a spacecraft cabin cannot be eliminated, it can be reduced by maintaining the oxygen level below hazardous levels and by carefully selecting materials for compatibility with the O₂ atmosphere.

Oxygen pressure must be maintained below 30% of total pressure. While O₂ levels need to be high enough to sustain respiration, the presence of O₂ can be hazardous because it accelerates combustion. The nominal physiological range of O₂ partial pressure is 2.7 – 3.4 psia (19 – 23 kPa). These limits, however, may be exceeded for a limited amount of time (see section 6.2.2.2.3, “Oxygen Level Limits”). In an O₂-enriched atmosphere that is greater than about 23% O₂, some materials that are noncombustible in air can easily burn. High-pressure O₂ is even more hazardous. The Apollo 1 fire, started by a spark in the 15-psi 100% O₂ atmosphere, quickly consumed the command module.

Materials used in pressurized cabins of spacecraft must have high ignition temperatures, slow combustion rates, and low potential for explosion. Some materials that have been approved as having a low risk of flammability for space flight are Nomex and GORE-TEX®. A secondary method to reduce hazards from fire is to incorporate within the design the ability to localize and contain a fire if one were to start. The use of panels, internal fire dividers, and port holes to provide extinguishers with access to interiors, are features of the design of pressured cabins on the ISS.

6.2.4.3.3.2 Fire Detection

Once a fire does occur, the first step in protecting the crew is detecting the fire. In microgravity, the lack of natural convection requires airflow to move smoke and other combustion products near sensors or crewmembers to be detected. This is especially true for enclosed and out-of-sight regions, such as equipment bays. Even in a gravity environment, airflow and placement of fire or smoke sensors is important.

When designing fire-detection systems, consider the following features:

- Smoke detectors should be located in equipment bays, the cabin, and nearby ventilation return ducts.
- Airflow must be provided in occupied areas to make smoke visible and/or cause its odor to be detected.
- The fire-detection system must be capable of operating independently of other components of a caution and warning system in the event of a triggered power failure or failure of an associated system.

- Failures of the fire warning system must be annunciated to the crew, due to the extreme danger a fire presents.
- Since the first detection of the fire may be a visual or olfactory indication to a nearby crewmember, the fire-detection system must be capable of being manually activated in the event a fire is detected by a crewmember, who could then warn other crewmembers.

6.2.4.3.3 Fire Extinguishing

Once a fire is detected, crewmembers need to act quickly to extinguish it. Selection of fire-extinguishing systems for spacecraft has presented unique problems. In microgravity, the extinguishing system must be usable without assistance from gravity conditions. The selected extinguishing agent must not:

- Support combustion in an O₂-enriched environment
- Contain toxic agents
- Emit toxic products when applied to a fire
- Interfere with visual observation
- Be difficult or time-consuming to initiate

Portable breathing apparatuses are needed to protect the crew from smoke and combustion products, and must allow communication between crewmembers and with ground personnel.

Because fire cannot continue without O₂ (or other oxidizers), the ability to stop the flow of O₂ into the cabin must be provided. If loss of O₂ in an unoccupied area or isolated compartment can be tolerated, then the use of depressurization for fire control or cleanup should be considered. However, the characteristics of the fire and the burning agent determine how to handle the fire in terms of airflow distribution and pressurization. Cabin depressurization may be useful in addressing a fire, but may initially accelerate flame propagation depending on the location of depressurization valves (i.e., they may increase airflow to the fire) and other considerations. Cabin depressurization may be impractical for the following reasons:

- Crewmembers will need to don spacesuits, which requires time and which may have to occur in poor lighting or visibility.
- The quantity of O₂ on board may be inadequate to replenish the atmosphere.

Design of the spacecraft and its components must provide for rapid access to fire-extinguishing equipment (e.g., fire port holes for manually supplying extinguishing material could provide access to all potential sources of fire). Portable fire extinguishers must be provided for extinguishing fires in open areas, as well as areas behind panels.

Resources for recovering from a fire must include proper procedures for removal of contaminants from the atmosphere, and the ability of the crew to determine if the atmosphere is safe enough for them to remove their breathing apparatuses.

Fire extinguishing has been accomplished in different ways on different spacecraft, including the following examples:

- Space Shuttle – On the Space Shuttle, the fire extinguisher contained Halon. However, Halon creates a toxic atmosphere that is difficult to clean up after dispersion, requiring venting of the cabin or return to Earth. Halon also does not possess any cooling properties to be able to reduce heat from the fire and prevent melting of structures or equipment.
- ISS – The ISS has a portable CO₂ extinguisher for use in the U.S. modules, and two types of water-based extinguishers for the Russian modules.
 - The U.S. Portable Fire Extinguisher (PFE) is used for extinguishing fires or suspected fires behind rack bay closeouts or in module open areas, and is designed to be operated with one hand. The PFE consists of a large pressurized cylinder, trigger mechanism, handle, and nozzle attachment. The PFE can accommodate either a tubular nozzle designed to be inserted into rack extinguisher ports, or a conical nozzle for fires in open areas. The PFE uses pressurized (850 psi) gaseous CO₂ as the extinguishing agent. A fully discharged PFE will fill a full U.S. rack bay with CO₂ to the point that the O₂ concentration is 10% or less. The CO₂ is removed by the ISS ECLSS.
 - The Russian OCII-4 is a backpack-style fire extinguisher used to control and suppress localized fire aboard the ISS. The OCII-4 is mounted on brackets and is automatically activated when removed. The fire suppressant is 2.5 kg (5.5 lbs) of a solution of 3% foaming agent (PO-3A1, a secondary alkyl sulfate solution) and 97% distilled water. When released, the suppressant produces a nontoxic foam that is 40 times its initial volume. The suppressant is fed by 0.3 kg (0.7 lbs) of compressed sulfur hexafluoride (SF₆). The duration of uninterrupted operation of the fire extinguisher is approximately 1 minute, and it may not be used a second time if the contents are not fully used. The fire-extinguishing agent may be released in two different modes, as a liquid spray or as foam. An open-cabin fire is extinguished by using the fire extinguisher in the liquid spray mode. If there are no visible flames but smoke is present, the foam mode is used.
 - The Russian OKP-1 is a hand-held fire extinguisher used to control and suppress localized fire aboard the ISS. The OKP-1 is mounted on brackets. It contains a 6% solution of foaming agent in distilled water as the extinguishing agent (OTB). The OTB, its foaming products, and the products of their interaction with the fire are nontoxic. The foam clings to the surface of materials and remains there until it breaks down (evaporates), it does not harden, and if necessary it can be wiped clean using towels. The OTB does not chemically react with interior materials and hardware. The foam is stable for at least 5 minutes (the time required for 50% of the foam volume to settle). The OTB and its decomposition products do not disrupt the operations of the regeneration systems. Figure 6.2-10 is a diagram of the OKP-1.

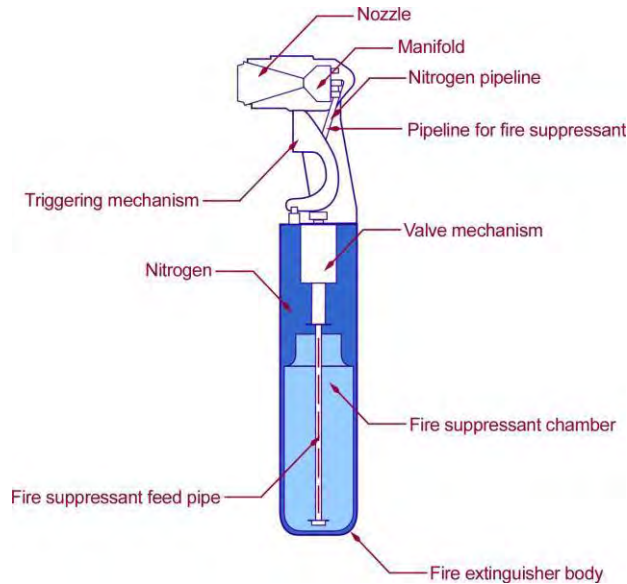


Figure 6.2-10. Russian OKP-1.

The combination of CO₂ fire extinguishers and water-based fire extinguishers has proven to be very useful. In the event of a fire, CO₂ will extinguish almost any type of fire and the ISS also has CO₂ filters to clean CO₂ out of the atmosphere. However, during the fire on *Mir*, the fire had its own O₂ source and the U.S. CO₂ fire extinguisher would have been ineffective. Thus, use of the Russian water-based fire extinguisher was critical and kept the *Mir* bulkhead cool enough to prevent the structure from melting or the occurrence of a pressure leak.

6.2.4.3.4 Off-Gassing

Spacecraft that will be entered by crewmembers for the first time in space, such as new modules attached to the ISS, need to be tested for off-gassing to determine if there will be a hazard to the crew when they first enter the module and to estimate the additional load on the ECLSS.

For the initial test of Node 1, it was learned that any fresh use of adhesives and similar material that need to cure will cause the module to fail the test. Careful choices need to be made about which solvents and volatile materials are used in preparation and cleaning of the interior of a module to limit airborne volatile contamination on first entry.

6.2.4.3.5 Propellants

Since EVA translation paths or worksites may be located on the exterior surface of a spacecraft, the design of the spacecraft and location of translation paths must prevent contact with potential contamination sources, such as propellants.

Also, on landing and egress, the crew must not come in contact with residual propellants. The only incident in which propellants caused significant health effects on the crew occurred during the descent of the *Apollo-Soyuz* Test Project, when nitrogen tetroxide propellant entered the spacecraft due to inadvertent Reaction Control System jet firings while the pressure equalization valve was open to the outside. Upon landing, the Reaction Control System isolation valves were closed and the crew donned oxygen masks. One crewmember was unconscious when the capsule

was opened. The crew complained of burning of the eyes, burning and itching of the skin, and chest and breathing problems, but all fully recovered within 4 weeks of landing. The lesson learned is that thrusters cannot be placed where their products can enter the atmosphere of the habitable volume of a spacecraft.

Lesser concerns have arisen over the possibility of propellants getting on EVA suits and being inadvertently brought into the airlock. This concern has been addressed by flight rules that call for suit brushing and bake-out if contamination is suspected, and then propellant monitoring in the airlock. Precautions are in place to keep the EVA crew away from the fuel-oxidizer residue product that accumulates around the nozzles of some thrusters on the ISS.

6.2.5 Research Needs

The need for broad-spectrum toxic compound monitoring is dictated by the possibility of slow accumulation of volatile pollutants and by the possibility of accidental release of a volatile compound(s) from hardware maintenance (e.g., Elektron), small pyrolysis events, or unpredictable events such as the Metox regeneration. Analyzers need to detect and quantify alcohols, ketones, aldehydes, aromatics, Freons, and siloxanes. In general these need to be detected at 0.1 mg/m^3 with a dynamic range approaching two orders of magnitude. Such instruments need to be reliable (> 1 year untended operation), small $< 250 \text{ in}^3$ ($< 4097 \text{ cm}^3$), and able to give the crew a simple but relevant display of pollution levels. Such instruments need to be capable of functioning during an accidental release when the atmosphere may be 10-fold more polluted than under nominal conditions.

6.3 WATER

6.3.1 Introduction

Water is a critical space flight resource that needs to be carefully managed for crew health and safety. In the context of human space flight, water has a variety of uses to support crew health, including hydration, food rehydration, and personal hygiene. Water is also used for technical purposes: as a coolant for various systems, as flush water for sanitary purposes, and even as a source of oxygen.

In this section, the quality and quantity of water needed for the various uses is discussed as well as the measures to ensure space flight water quality, including defining contaminant limits, monitoring, and mitigation. This focus includes toxicological and microbiological parameters associated with crew health aspects of maintaining the quality of the potable water supply.

This section also addresses operational concerns of providing safe, useful, and palatable water including water sources, access, flow rates, and temperature guidelines.

Additional considerations related to water can be found in chapter 11, “Extravehicular Activity.”

6.3.2 Water Quality

The quality of water can vary, depending on whether and how it is filtered or purified. Water of sufficient quality to be ingested by humans is termed potable water. Any water used by the crew for drinking or hygiene must be potable, to ensure crew health and to not predetermine which quantities of water are to be used for which purposes. In describing water quality, the discussion will focus on identification of contaminants, the establishment of safe levels of exposure, and the monitoring necessary to ensure that those exposure limits are maintained.

6.3.2.1 Water Contamination

The types of contaminants that are of concern in a spacecraft are not the same as those that pose a risk to groundwater or surface water resources on Earth. Factors such as the use of recycled spacecraft humidity condensate as potable water introduce different risk factors and require a change in technical perspective. Figure 6.3-1 illustrates the possible sources of contamination of space flight water that should be considered when assessing water quality.

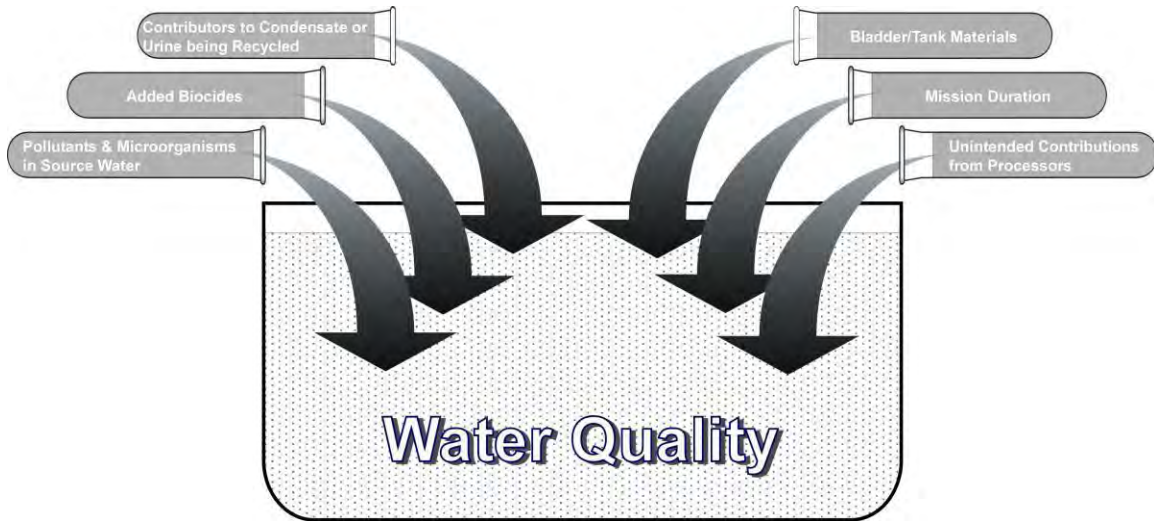


Figure 6.3-1 Diverse challenges to water quality in space flight.

Table 6.3-1 shows possible water contamination sources, the process by which the contamination occurs, and some of the specific chemical contaminants.

Table 6.3-1 Water Chemical Contamination Sources

Water Contamination Source	Contamination Process	Specific Contaminants
Contamination of Ground-Supplied Water	<ul style="list-style-type: none"> • Present in the source water • Introduced unintentionally during processing • Derived from the material that comprises the bladder and/or on-orbit delivery tank, or is transferred by a dispensing system 	
In-Flight Contamination	<ul style="list-style-type: none"> • Recycled humidity condensate may contain water-soluble chemicals that are transferred from the spacecraft atmosphere. 	<ul style="list-style-type: none"> • Contaminants from a diversity of chemical-containing spacecraft payloads and materials (Schultz et al., 2006) • Airborne microbes, chemicals
	<ul style="list-style-type: none"> • Human metabolic products 	<ul style="list-style-type: none"> • Organic acids and esters • Pharmaceutical agents • Drug metabolism byproducts

Water Contamination Source	Contamination Process	Specific Contaminants
Compounds that Are Purposely Added to Spacecraft Water	<ul style="list-style-type: none"> Compounds purposely added to spacecraft water 	<ul style="list-style-type: none"> Iodine or silver added because of their biocidal properties Minerals (e.g., calcium, magnesium) to improve palatability or offer dietary enhancement

6.3.2.1.1 Chemical Contaminants

Table 6.3-2 is a list of primary chemical contaminants that are present in recent space flight water sources. For the ISS, this list is specific to raw condensate. Raw condensate is not consumed by the crew without extensive processing that is extremely effective in removing pollutants of concern.

Table 6.3-2 Comparison of Chemical Contaminants of Concern from Different Potable Water Sources

ISS U.S. Laboratory Condensate	Shuttle Water (fuel-cell water)	Ground-Supplied Russian “Rodnik” Water (transported by unmanned Progress vehicle)
Benzyl alcohol	Nickel ^a	Chloroform
Ethanol	Ethanol ^b	Manganese
Methanol	Iodine ^b	Silver ^b
Acetate	Free gas	Turbidity
Formate	Cadmium ^a	
Propionate	Lead ^a	
Zinc ^a	Caprolactam ^c	
Nickel ^a		
Formaldehyde		
Ethylene glycol		
Propylene glycol		

^a Generally resulting from releases from metallic heat-exchanger coatings, or dispenser parts

^b Related to biocide addition

^c Resulting from leaching of bladder material

6.3.2.1.2 Microbiological Contaminants

Ingestion of potable water is considered a likely source of infectious disease during flight, as the medium provides an opportunity for microbial growth and a potential route of infection by many pathogens that may affect crew health. Spacecraft should include mitigation controls that are designed into the spacecraft. Most of these controls are not unique to space missions and are common in terrestrial use, such as the use of filters and residual disinfectants in potable water systems. When such controls are combined with operational controls during flight, the spread of microbial contamination should be minimal even during extended-duration missions.

The risk of contracting infectious disease during space missions is composed of multiple factors including the concentration and characteristics of the infectious agent. Although stringent steps are taken to minimize the transfer of potential pathogens to spacecraft, several medically significant organisms have been isolated from spacecraft potable water. These organisms include opportunistic pathogens, such as *Stenotrophomonas maltophilia* and *Pseudomonas aeruginosa*, which have been isolated from the ISS potable water systems (Bruce, Ott et al. 2005). Spacecraft design needs to include measures to minimize microbial concentrations and organisms that would be considered medically significant. When exposure of crewmembers to microorganisms during a mission is limited, the chance of a crewmember encountering medically significant organisms at an infectious dose is minimized.

6.3.2.2 Water Quality Limits

Once pollutants and compounds of concern in spacecraft potable water are identified, it is necessary to set appropriate health-protective water quality limits for chemical constituents. Likewise, appropriate microbial requirements, based on expected microbial diversity, must be established. Two types of errors can be made in setting water quality limits:

- Limits that are too high can lead to an immediate (acute) or long-term (chronic) risk to crew health.
- Conversely, limits that are inappropriately low can result in making unnecessary changes in system designs (e.g., through incorporating specially designed filters or unnecessarily excluding certain materials from use in construction), reprocessing or discarding vital water resources, or incorrectly focusing limited crew and ground support time and resources on addressing benign issues.

Although both types of errors need to be avoided, an intentional bias exists toward crew health protection in setting exposure limits when data are sparse and assumptions need to be made.

It is beyond the scope of this handbook to fully present the variety of risk-assessment considerations and toxicity and microbiological evaluation strategies that are used in setting water quality limits. “Methods for Developing Spacecraft Water Exposure Guidelines” (NRC2000) is an excellent resource for toxicological considerations.

6.3.2.2.1 Chemical Limits

For missions between 100 and 1,000 days in duration, water quality must meet the limits in Table 6.3-3. For other mission durations, limits for the compounds in Table 6.3-3 must be established using available NASA Spacecraft Water Exposure Guidelines (SWEGs). For crew exposures beyond 1,000 days, additional research may be required to ensure crew health protection. Table 6.3-3 is intended as a guide, and is not meant to be all-inclusive of the types of compounds that may be of concern in space flight water. If the presence of another compound is anticipated, it will generally be necessary to establish limits to ensure crew health protection. U.S. Environmental Protection Agency maximum contaminant levels can generally be applied as conservative guidelines, but may be overly stringent for many compounds (<http://www.epa.gov/safewater/contaminants>). Accordingly, it is generally recommended that

the NASA water quality technical monitor (JSC SLSD) be contacted for more specific guidance on appropriate limits for any particular compound in question.

In assessing water quality on Earth, health-based limits for many pollutants and compounds of concern have been set by the Environmental Protection Agency in the form of maximum contaminant levels, or health-advisory levels. NASA has established a relationship with the NRC to form a Subcommittee on Spacecraft Exposure Guidelines. The NRC subcommittee works with NASA to establish water quality limits, referred to as SWEGs, that are based on the unique characteristics of astronauts and space missions. The following are some of the assumptions made when SWEGs are established:

- The astronaut population is healthy and prescreened.
- Exposure is over much shorter durations than ground lifetime limits.
- Unique physiological changes and challenges associated with space flight need to be considered. For example, space flight can result in crewmembers having a reduced mass of red blood cells, a factor that should be considered when determining a water quality limit for a pollutant that may cause anemia.
- The average crewmember has a standard adult body weight of 70 kg (154 lb).
- A crewmember consumes 2.8 L of water per day on average (including use in food rehydration, etc.).

SWEGs are established for specific exposure timeframes: 1, 10, 100, and 1,000 days. The 100- and 1,000-day limits are used for nominal mission planning; the 1- and 10-day limits are used only for contingency planning.

For the most current SWEG data, refer to the latest version of JSC 63414 .

For a given spacecraft design, the expected chemical compounds and longest expected crew exposure length should be determined, and physiochemical limits defined per the SWEGs. Some compounds may be permitted at higher levels for shorter durations. In applying these limits, note that crew exposure to water may extend beyond the short-term period when water is delivered. For example, a mission to the ISS could last only a week for a crew, but water delivered to the ISS by the mission may be on board for several months.

Table 6.3-3 Potable Water Physiochemical Limits

Chemical	Limit	Units
Ammonia ¹	1	mg/L
Antimony ¹	2	mg/L
Barium ¹	10	mg/L
Cadmium ¹	0.022	mg/L
Manganese ¹	0.3	mg/L
Nickel ¹	0.3	mg/L
Silver ¹	0.4	mg/L
Total iodine ²	0.2	mg/L
Zinc ¹	2.0	mg/L

Chemical	Limit	Units
Total organic carbon ¹	3	mg/L
Acetone ¹	15	mg/L
Alkylamines (di) ¹	0.3	mg/L
Alkylamines (mono) ¹	2	mg/L
Alkylamines (tri) ¹	0.4	mg/L
Benzene ¹	0.07	mg/L
Caprolactam ¹	100	mg/L
Chloroform ¹	6.5	mg/L
Di(2-ethylhexyl)phthalate ¹	20	mg/L
Di-n-butyl phthalate ¹	40	mg/L
Dichloromethane ¹	15	mg/L
Ethylene glycol ¹	4	mg/L
Formaldehyde ¹	12	mg/L
Formate ¹	2500	mg/L
2-Mercaptobenzothiazole ¹	30	mg/L
Methanol ¹	40	mg/L
Methyl ethyl ketone (MEK) ¹	54	mg/L
Phenol ¹	4	mg/L
n-Phenyl-beta-naphthylamine ¹	260	mg/L
Propylene glycol ¹	1700	mg/L

¹1,000-day SWEG in Johnson Space Center (JSC) 63414, Spacecraft Water Exposure Guidelines.

²Derived from the total iodine intake limits specified in Shuttle Flight Rule A13-30.

6.3.2.2.2 Microbial Limits

Microorganisms are widespread in nature and have developed mechanisms for colonization and growth even under hostile conditions. Thus, microorganisms have been isolated from water system samples in locations that might not seem intuitive. Acceptability limits for the concentration of microbiological constituents, such as bacteria, fungi, and protozoa, and the location of sampling are different for the different spacecraft in each space flight program. Other factors influencing microbiological limits include the duration of the mission, susceptibility of the crew to infectious disease, environmental factors that influence microbial characteristics, and exposure of the crew to infectious agents. Examples of current acceptability limits for two mission scenarios are provided below. Future requirements may change, depending on mission architecture and technological advancements in monitoring,

Potable water must be maintained at or below the microbial limits of Table 6.3-4 for missions less than 30 days.

Table 6.3-4 Potable Water Microbiological Limits for Missions of Less Than 30 Days

Characteristic	Maximum Allowable	Units
Bacterial Count	50	CFU/mL
Coliform Bacteria	Non-detectable per 100 mL	-
Fungal Count	Non-detectable per 100 mL	-
Parasitic Protozoa (e.g., <i>Giardia</i> and <i>Cryptosporidium</i>)	0	-

Examples of microbiological requirements for potable water on ISS are shown in Table 6.3-5, documented in the Space Station Program (SSP) 50260 International Space Station Medical Operations Requirements Document. On the ISS, maintenance of these specifications has been accomplished using flow through a 0.2-micron filter and use of a residual biocide.

Table 6.3-5 Potable Water Microbiological Limits for the International Space Station

Water Parameter	Units	Russian Ground-Supplied Potable SVO-ZV	Regenerated Potable SRV-K	Hygiene	Shuttle-Supplied Potable CWC	Shuttle-Supplied Technical CWC
Bacterial count	CFU/mL	50	50	1000	50	50
Coliform bacterial count	CFU/100mL	Non-detectable	Non-detectable	Non-detectable	Non-detectable	Non-detectable
Protozoa	-	TT	TT	TT	TT	TT

CWC = Contingency Water Container; CFU = colony-forming unit; TT = treatment technique. Source water filtered through a 1- μ m filter. No analysis is required.

6.3.2.2.3 Aesthetic Limits

Drinking water must meet the physiochemical limits defined in Table 6.3-6. These limits on water quality are needed for water palatability to the crew. It is a significant crew health risk if the crew does not drink enough water. Therefore, all reasonable steps should be taken to ensure that the water is palatable to the crew.

Table 6.3-6 Potable Water Aesthetic Limits

Quality	Limit	Units
Taste	3	TTN
Odor	3	TON
Turbidity	1	NTU
Color, True	15	PCU
Free & Dissolved Gas ^a	0.1	%
Acidity (pH)	4.5 - 9.0	N/A

TTN, threshold taste number; TON, threshold odor number; NTU, nephelometric turbidity unit; PCU, platinum-cobalt units; N/A, not applicable.

^aFree gas at spacecraft atmospheric pressure and 98.6°F, dissolved gas saturated at spacecraft atmospheric pressure and 98.6°F.

Some evidence suggests that the addition of certain minerals (e.g., calcium, magnesium, sodium) may improve the taste of potable water. In support of this, it is worth noting that virtually all bottled drinking waters sold commercially are mineralized. However, no credible evidence indicates that consumption of water without these minerals is a health concern. The spacecraft diet is carefully controlled, and evaluations ensure that these minerals are provided in adequate amounts in the crew diets.

The Low Iodine Residual System (LIRS) was designed to reduce iodine and iodide contents of the Shuttle water and was flown as a detailed test objective on Space Transportation System (STS)-95. An adverse taste in the water was reported after the LIRS was activated on orbit for the STS-95 flight. Analyses of both in-flight samples and samples from an LIRS cartridge prepared for flight showed that tripropylamine and tributylamine were detected. Further investigation confirmed that these trialkylamines were released during gamma sterilization of the LIRS resin materials and these compounds caused the adverse taste. Although these compounds did not create a direct health hazard, the adverse taste caused the crew to drink less water, which could have led to dehydration and other health problems over a longer duration. During the acceptance and certification process, the LIRS was not completely tested after gamma sterilization since it was not classified as critical hardware. The lessons learned from this experience were that all hardware (system or payload) related to the life support system must be classified as critical hardware and the certification testing of the hardware needs to be conducted on the final flight configuration.

6.3.2.3 Shelf Life

To allow operational flexibility and to relieve design constraints on when ground-supplied water needs to be stowed, the shelf life of ground-supplied water at ambient cabin temperature should be at least 6 months. The documented shelf life of Contingency Water Container potable water stored in the current-design Contingency Water Container is 64 weeks, based on the results of ground-based testing. Longer shelf life will likely be required for Mars missions.

6.3.3 Water Quantity

The water quantities in Table 6.3-7 must be met to ensure crew health. Water is needed in sufficient quantity to meet human consumption and hygiene needs for nominal and off-nominal conditions. Water is required for

- Hydration (drinking)
- Food and beverage rehydration
- Personal hygiene
- Medical use
- End-of-mission fluid loading
- Hydration on Earth post landing and before recovery of the crew
- Inflight or archive monitoring to verify water quality and crew health protection
- EVAs as required

Table 6.3-7 Minimum Quantity Needs for Potable Water

Purpose	Quantity	Rationale
Hydration (drinking)	2.0 kg (4.4 lb) per crewmember per mission day	Individuals vary in the amount of water they need for hydration, depending on body mass, physical activity, and other factors. The current ISS water quantity is 2 kg per crewmember per mission day
Food rehydration	Approximately 0.5 kg (1.1 lb) per crewmember per mission day	Value of 0.5 kg water for food rehydration is based on current (2007) ratios of thermostabilized, freeze-dried, and natural-form foods from the ISS menu. If the ratio of thermostabilized, freeze-dried, and natural-form foods is revised, the water quantity must be adjusted.
Personal hygiene	0.4 kg (0.88 lb) per crewmember-day	Clean water is necessary for maintaining skin, hair, and dental health of crewmembers. Some of this water quantity can be met with water in pre-wetted towels.
Fluid loading	1.0 kg (2.2 lb) per crewmember	The 1.0 kg (2.2 lb) quantity is based on the Shuttle aeromedical flight rule for entry fluid loading, which requires 1.5 L (48 oz) for initial fluid loading; however, 0.5 L of this comes from unconsumed daily water allocation per crewmember. This allocation protects for nominal end-of-mission fluid loading plus one additional wave-off opportunity, if applicable, 24 hours later. Lunar missions would not have a wave-off opportunity. Without the additional water allocation, the crew might have inadequate water available to fluid load and thus have hemodynamic compromise during and after deorbit. Having inadequate fluid loading will almost certainly cause physiological difficulties in some, if not most, crewmembers.
Hydration on	4.5 kg (9.9 lb) per	4.5 kg is based on each crewmember needing 1.0 kg

Purpose	Quantity	Rationale
Earth post landing	crewmember	(2.2 lb) per 8-hour period, for 36 hours of post-landing recovery.
Medical use	5 kg (11 lb) plus 0.5 kg (1.1 lb) per crewmember	5 kg would be used for a medical contingency, including irrigation of eyes and wounds after exposure to a toxic level 2 substance. 0.5 kg provides for eye irrigation of normal particulate exposure (i.e., dust, foreign object).
Hydration on EVA	0.24 kg (0.5 lb) per hour above nominal water provision	Potable water is necessary during suited operations to prevent dehydration due to perspiration and insensible water loss as well as to improve crew comfort. The additional 240 mL (8 oz) is based on measured respiratory and perspiratory losses during suited operations. During a lunar EVA, crewmembers will most likely be suited for 10 hours, and for approximately 7 of those hours they will be expending energy on the lunar surface. Apollo Summit strongly recommended the availability of this quantity of water for consumption during a lunar EVA.

Additional water for hydration may be needed for certain tasks, including EVA and exercise.

6.3.4 Water Temperature

The water temperature ranges in Table 6.3-8 must be met to ensure crew health and comfort. Different water temperatures are needed to support food and drink rehydration, personal hygiene, and medical tasks during space flight missions. From the perspective of crew palatability and preference, cold and hot drinks become more important for missions of longer duration.

Table 6.3-8 Water Temperatures

Use	Temperature Range	Constraints and Rationale
Rehydration of cold drinks	Maximum of 15.6°C (60°F). Cold water temperature between 2°C (35.6°F) and 7°C (44.6°F)	For missions longer than 3 days
Rehydration of food and hot drinks	Between 68.3°C (155°F) and 79.4°C (175°F)	Temperatures were selected for better rehydration of food and beverages and to maintain food temperature during the rehydration process so that the completed food product does not require additional heating. 79.4°C (175°F) water also allows the temperature of the food to remain above 68.3°C (155°F) to prevent microbial growth.
Personal hygiene	Between 29.4°C (85°F) and 46.1°C (115°F)	Supports body cleansing
Medical	Between 18°C (64.4°F) and 28°C (82.4°F)	This temperature range will prevent thermal injury and discomfort to tissues during irrigation.

6.3.5 Water Quality Monitoring

Maintaining water quality requires early identification and mitigation of potential water quality impacts. Preflight, in-flight, and postflight monitoring procedures allow verification of water quality, evaluation of trends, and documentation of potential exposures.

6.3.5.1 Preflight Materials Evaluations and Testing

Preflight efforts to ensure water quality are critical. The following measures are examples of proactive safety considerations used by the ISS Program and essential for all programs:

- Container System Evaluations – Materials and payloads used for containing water are carefully evaluated by water quality engineers, NASA toxicologists, and the rest of the safety community to ensure that any adverse effects on water quality are anticipated and mitigated.
- Recovery Systems Testing – Water recovery systems are required to clearly demonstrate their performance in extensive ground-based testing.
- Container Longevity Evaluations – Containers used to transfer potable water are subjected to longevity studies and tests designed to reveal unacceptable levels of component leaching.
- Additional analytical studies (e.g., ensuring that materials are selected from a list that incorporates compatibility considerations).

6.3.5.2 Preflight Monitoring

Comprehensive water sampling must be conducted before launch on potable water that is prepared on the ground and loaded for flight. It is critical that problems be identified as early in the process as possible to maximize flexibility of any mitigation efforts. Therefore, the timing of the sampling should allow time for mitigation steps if any concerns are identified. Extensive preflight sampling was conducted on Shuttle water, with samples collected 15 and 3 days before launch (L-15, L-3). Although this schedule was set for the Shuttle Program, the exact timing of these samples may be somewhat flexible. The samples should be collected late enough that minimal changes are made after they are collected, and the community can be confident that the samples are representative of launched water. Conversely, any anomalies should be addressed early enough for the concern to be reasonably serviced or otherwise mitigated. Thus, some balancing needs to occur on the exact dates selected for sampling, and the dates will likely depend on the spacecraft. The current L-3 sample is useful, but provides water-quality data that can really be considered only after launch, when it can be used in health decision-making to ensure that water-quality requirements are met (Hwang et al., 2006). Russian ground-loaded water is also tested and evaluated before flight.

Water sampling must be performed before and after biocide addition to ensure the quality of the ground servicing equipment before the spacecraft water system is serviced, as follows:

- Immediately after tank disinfection and initial filling
- Between servicing and final preflight sampling after launch has been delayed, after samples have been found to be out of specification, or after equipment has malfunctioned (samples must be collected a minimum of every 90 days)

- L–15 days
- L–3 days

The need for preflight water samples demands that systems be designed with this need in mind. Access to any stowed ground-supplied water should be made as easy as practical, and preflight operations timelines should allow sampling time.

6.3.5.3 In-Flight Monitoring

The following criteria for in-flight monitoring of water quality apply to all missions:

- The capability to collect samples during flight must be provided.
- The water system volume should accommodate in-flight sampling of at least 500 mL.
- The capability to store samples for postflight analysis should be provided. However, in-flight analysis should be considered for missions to the Moon and Mars, as return mass will be limited.
- Communications with technical experts to resolve any quality concerns should be provided.

Real-time monitoring involves the use of technologies focused on generating data concerning a specific pollutant that can be evaluated quickly during a flight. Ideally, all monitoring information would be available in real time so that health and safety decisions could be made in an expeditious manner, with minimal uncertainty.

In the absence of specific technologies for all pollutants, total organic carbon (TOC) is a general chemical parameter that has been valuable in evaluating water quality in the spacecraft environment, at least with respect to organic compounds. While not compound-specific (TOC data reflects any organic carbon that is present in the sample), TOC can provide a useful screening tool. By setting an appropriate screening limit (through assuming that a reasonable worst-case compound is contributing the TOC), NASA can make real-time decisions as to whether the organic pollutant load is low enough to be health-protective. However, a tradeoff for not having specific data for each individual pollutant is that false positives can occur (i.e., TOC may be elevated by a low-toxicity compound) when this screening approach is followed.

In addition, for missions lasting from 2 to 4 weeks, and those involving consumption of water from recycled humidity condensate or urine, provisions must be made for in-flight testing of the water for pH level, total organic carbon, and biocide levels. Four weeks is based on an estimate of the mission length that might require potable water recovery from recycled sources. An in-flight monitoring solution is the Total Organic Carbon Analyzer (TOCA) that has been used on the ISS in the past; a next-generation unit was delivered in 2008. Missions of longer duration may require autonomous monitoring or hardware that requires minimal consumables.

6.3.5.4 Archive or Postflight Monitoring

Despite the importance placed on preflight evaluations, these measures are not meant to eliminate the need for post-launch water-quality monitoring as a foundation of space flight safety. A second general class of monitoring, the collection of archive samples, is currently the

most used method and presents a number of advantages and disadvantages. With archive sampling, water samples are collected during flight and returned to Earth in specially designed sampling bags to preserve sample integrity. Water systems should be designed to accommodate at least a 1-liter archive sample if necessary for a given flight. These samples are then analyzed in ground-based laboratories. The main disadvantages of this approach are 1) the inability to make real-time decisions based on the data, and 2) for long-duration or distant missions, returning samples for analysis may not be practical. However, a much more complete list of analytes can be tested than is possible with real-time monitors. Heavy reliance on archive samples places greater significance on the regular return of samples for analysis. Since there is tremendous competition for crew time resources (which affects the sample collection schedule) and down mass, this is an area that requires vigilant advocacy to ensure that adequate data are available to reliably make crew health decisions. Ideally, when water potability is monitored strictly through the use of archive samples, such as for ISS CWC potable water, the water to be tested is stored and not released for consumption until ground-based analysis results have confirmed potability. For long-duration missions with limited or no opportunity to return archive samples, increased risk will be associated with crew consumption of untested water. Such missions would benefit from improved capability for in situ analysis.

Archive samples from the ISS stored water system, which is dispensed through a Russian system called the “SVO-ZV,” were returned and analyzed for a suite of contaminants (Straub et al., 2006). Cadmium was observed to be present at levels that were not a health threat, but were higher than normally observed on the ISS. Evaluation of the source water for that system (ground-loaded “Rodnik” water) showed cadmium to be below analytical detection limits. The dispensing system was found to be introducing low levels of cadmium; cadmium levels in an initial “flush” of water from the dispenser (water that had a longer residence time in the system) were much higher than in post-flush samples. Subsequently, it was decided that replacement of the SVO-ZV dispenser was warranted.

6.3.5.5 Microbial Water Monitoring

Although prevention is the primary method for control of microbial contamination, the success of that prevention and its true contribution to risk reduction is determined by the actual concentration of microorganisms in the water and their characteristics (usually determined by their genus and species identification). Historically, these variables have been measured by growth on media and biochemical testing. Although changes in technology may increase the quality and quantity of data and improve the risk assessment, previous flight experience and research experiments have provided a solid basis from which to plan future monitoring and assess the current risk. Depending on the spacecraft design, monitoring must include preflight sampling and analysis, and should include in-flight and postflight sampling and analysis. Monitoring of both microbial concentration and characterization is preferable, though available resources and time may limit full characterization.

Collection and analysis of samples from a potable water system requires adequate sample volumes to accurately reflect the bacterial concentration in a system. To avoid sampling small, stagnant dead legs associated with sample collection pipes and valves, an initial flush volume is collected and disposed of before samples are collected. The flush volume is selected to ensure that a representative, homogeneous sample will be collected from the water system. It is recommended that the initial flush volume be at least the same as the volume of the dead leg,

which will vary with system design. Historically, sample volumes of at least 100 milliliters have been collected from each sampling point after the initial flush has been collected. Designs incorporating pumped loops can eliminate stagnant zones and provide better mixing of biocides. Furthermore, when determining the amount of water needed for a mission, consideration should be given to the volume needed to accommodate sampling.

Other monitoring considerations include the following:

- During long missions or missions where the source of water creates an elevated risk, periodic testing of the potable water should be considered to monitor water quality and allow timely action if necessary. Short missions with simple water systems or open-loop systems will not require extensive microbial sampling and analysis. However, as mission duration and system complexity increase, the risk of microbial contamination will increase. Long-duration water systems, such as those in a remote habitat, will likely suffer a contamination event. Sources of potable water that are uncontrolled after launch have a greater risk of microbial contamination. These sources can include environmental sources such as humidity condensate or crewmember sources such as urine. In general, crewmember sources have a greater potential for carrying medically significant organisms. For this reason, source water that was loaded before flight may have less demand for water analysis than water recovered from the environment, which in turn may have a lower demand than water recovered from the crew. Water recovered from the crew requires specific tests to limit transfer of medically significant organisms. Monitoring frequency is often a function of the duration of the mission and source of the water.
- The spacecraft must have monitoring for its potable water system that fits within the limited resources available during a mission. Historically, resources such as crew time, power, mass, and volume have driven the need for small, simple hardware. Longer-duration missions may require autonomous monitoring or hardware that requires minimal consumables.

The SRV-K water regeneration unit aboard *Mir* pasteurized water at the galley immediately before dispensing. Monitoring of this “hot” water port indicated very low numbers of bacteria. However, after pasteurization the same water could also be piped through a heat exchanger, where the water temperature was decreased, and dispensed through a “warm” port at the galley. The bacterial concentration at this port was much higher and displayed a much greater diversity than the “hot” port. The probable cause was a biofilm created by bacteria that were able to survive the heat of pasteurization and grow in the heat exchanger. Thus, during spacecraft development, it should be recognized that contamination is possible at almost any point within the system.

6.3.6 Water Contamination Control and Remediation

Monitoring provides a means to ensure that water is safe and acceptable, but controls can also be put in place to prevent contamination of water once it has been delivered to the spacecraft. Contamination of water is typically biological, although the potential for chemical contamination exists as well as physical contamination from particles in the spacecraft, such as dust.

One common in-flight control is the use of water disinfectants. Disinfectants for microbial control of potable water are widely used in terrestrial water systems. Accordingly, NASA has used a disinfectant in every potable water system since the Apollo Program. Various disinfectants have been used successfully, including chlorine, iodine, and silver. While each has its own advantages, each also has limitations. Chlorine was used in the Command Module during the Apollo Program, but its use was curtailed because of incompatibilities with the water systems, such as corrosion and rapid loss of the biocide. Although iodine was used successfully for many years in the Space Shuttle potable water system, an investigation into deleterious effects of excess iodine on thyroid function revealed a potential hazard to crew health (Wiederhoeft et al., 1999). Restrictions on crew intake of iodine were enforced, greatly limiting the use of the disinfectant without a point-of-use decrease in concentration. The ISS contains Russian water systems, and for these, silver has performed well as a disinfectant. Still, previous experience with non-potable water systems, such as the Thermal Control System aboard the ISS, suggests that the “plating out” of silver on metal surfaces in the system could rapidly decrease the concentration of the disinfectant. Chemical and physical contamination are best prevented with proper material selection and by ensuring adequate separation between system interfaces.

Once a microbial or chemical contamination event is detected, remediation techniques aboard a spacecraft may be necessary to return the water to an acceptable quality. The determination of the need for such remediation capability is based on several factors such as the duration of the mission and the potential for medically significant organisms or chemicals to contaminate the water. The spacecraft must provide a mechanism for remediating potable water and the water system in general, if the risk of microbial or chemical contamination warrants this action. Remediation actions can include techniques to return the system water to its original state or techniques to convert the water after it is removed from the system.

The Russian water system on the ISS, the SVO-ZV, remediated microbial contamination using a 0.5 parts per million silver disinfectant. Unfortunately, multiple monitoring results of water from the SVO-ZV indicated that water exceeded the specification of 100 colony-forming units per 100 milliliters. To remediate the system, 10 liters of a 10-parts-per-million silver disinfectant was flushed into the systems. This action temporarily suppressed the bacterial concentrations, but the levels eventually increased above the acceptability limits again. This effect, called “regrowth,” is common in terrestrial water systems and suggests that a microbial biofilm is entrenched in the system. The usual in-flight remediation has been repeated treatments with biocides or replacement of system parts.

The “closed-loop” nature of spacecraft can pose a challenge when humidity condensate is recovered and treated for use as potable or technical water. That is because water-soluble volatile chemicals (e.g., low-molecular-weight alcohols) can be transferred to condensate from the spacecraft atmosphere. These compounds may be of toxicological concern (e.g., formaldehyde), but even high concentrations of relatively low-toxicity compounds (e.g., ethanol) can represent an increased load for the water recovery systems (affecting performance and consumable rates). For this reason, volatile usage limitations have been established on the ISS. Although carefully controlled, the list of compounds that could be potentially released to the atmosphere is quite extensive, especially given the diversity of chemical-containing spacecraft payloads and materials. Certain human metabolic products (e.g., organic acids and esters) are also important contributors of atmospheric pollutants (either through volatilization and solubilizing in humidity condensate or through direct water transfers through perspiration), and impacts from

pharmaceutical agents and drug metabolism should be considered. Through these controls, impacts on spacecraft water resources through the capture of atmospheric contaminants can be minimized.

6.3.7 Other Considerations

Space flight programs should consider the following operational aspects of supplying, using, and monitoring water:

- How to supply sufficient water quantity (sources)
- Access for water sampling before, during, and after flight
- Flow rate and quantity of water dispensing

6.3.7.1 Water Sources

Water sources can include bringing water, making it by means of fuel cells or in situ resource utilization, or recycling water (hygiene water, urine, humidity). The considerations about which type of water source to use are much broader than water-quality considerations. One advantage of using ground-supplied stored water is that generally, more opportunities exist for testing and remediation of launched water, which can reduce uncertainties about water quality. For long-term missions, however, the expense and logistics of launching stored water may be difficult to overcome. *Mir* and ISS experiences show that recycled water (from either humidity condensate or urine) can be used to provide high-quality potable water. However, careful monitoring or other controls are important in verifying system performance. Also, some additional risks are assumed because of the interrelationships between water and the atmosphere in a closed-loop spacecraft environment.

6.3.7.2 Water Access

Access to potable water systems must be provided for preflight, in-flight, and postflight analysis. Access should be provided as late as possible before launch, and as soon as possible after landing, to ensure that potable water systems function properly before and after a mission. Multiple access ports must be available for in-flight access, to ensure an accurate representation of potable water, including possible stagnant water locations.

6.3.7.3 Water Dispensing

Because crew time is valuable, consideration should be given to the rate of dispensing potable water. For the crew to be able to prepare for and perform tasks that require potable water in a reasonable amount of time, water must be dispensed at a rate of 500 mL/min (16.9 oz/min) or greater. This is based on a maximum of 30 seconds between fills.

To prevent overflow, water must be dispensable in specified increments that are compatible with the food and drink bags. Rehydration of food and drinks is designed for a specific amount of water, to ensure the desired texture and palatability.

6.3.8 Research Needs

For a variety of reasons, real-time monitoring capabilities are currently limited, accounting for a current inability to generate real-time water-quality data. To determine if future technologies can be used for in-flight, real-time monitoring, consider the following questions:

- Can the technology meet required analytical detection limits?
- Does the technology require resupply of consumables?
- Does the technology use chemicals or reagents that can pose a crew health concern in a closed-loop spacecraft environment?
- Does the technology have the specificity to handle mixtures of pollutants without affecting the reliability of the individual results?
- Can the technology be adapted to the uniqueness of a microgravity or partial-g environment? Is it rugged enough to perform in that environment?
- Does the technology minimize critical crew time?
- Are weight and power needs within practical limits?

A need exists for enhanced technologies that can provide real-time data on specific organic and inorganic compounds in water. Such technologies (e.g., colorimetric techniques that can provide data on iodine, silver, and other compounds) are being developed. The sensitivity of a monitoring technology to air-water separation is an important factor to consider, and one area of focus is on developing effective bubble mitigation techniques that can preserve analytical performance.

To allow operational flexibility and to relieve operational constraints on when ground-supplied water can be stowed, research is needed into how to prolong the shelf life of ground-supplied water at ambient cabin temperature, which may be required for Mars missions.

Developing a better understanding of changes that occur in microorganisms in a spacecraft, how the astronaut's susceptibility to disease may change, and how the organisms may adversely affect the spacecraft are needed to fully understand the microbial risk during space flight. In addition, technology to determine microbial concentration and organism characteristics will be required for future missions, especially as more crew autonomy is needed for mission success.

6.4 CONTAMINATION

6.4.1 Introduction

Contamination is a generic term describing the presence of an environmental constituent that has the potential to be a health hazard, cause damage to the spacecraft, or disrupt mission activities. Cross-contamination is the transfer of contaminants from one source to another. Exposure of space flight crewmembers to contamination may be chemical, biological, or physical in origin. The crew may be exposed to contaminants through the air, water, food, or spacecraft and equipment surfaces. Many constituents, such as dust or microorganisms, are naturally present in low numbers. When their concentration increases and their presence becomes a problem, these constituents are considered “contamination.” Thus, acceptability limits for many constituents are developed to minimize health risk to the crew.

To ensure crew health and safety, it is important to understand the types of potential contamination, the routes of exposure, and the potential hazards to the crew. In addition, spacecraft designs need to include the ability to monitor or measure the contaminant, the ability to prevent and mitigate the contamination, and to clean affected surfaces and systems to ensure a safe environment.

6.4.2 Contamination Type

Chemical contamination (examples are in parentheses) may occur as a result of leaks from spacecraft systems (Freon 218), use of utility chemicals (lubricants), human metabolism (carbon dioxide), microbial action (alkyl sulfides), pyrolysis (carbon monoxide), use or leakage of chemicals in payloads (fixatives), use of medications (vasodilators), or external reactive dust (fresh lunar dust). Contamination from some of these sources can be predicted; however, some forms of contamination are nearly impossible to anticipate.

Biological contamination includes microorganisms, such as fungi, viruses, and bacteria. Sources of these microorganisms include food, payloads, potable water, spacecraft surfaces, and the crew themselves. Microorganisms can easily become widespread, and any uncontrolled interface poses the risk of contamination. Preflight screening and quarantine mitigate the risk of carrying medically significant organisms. Space flight foods can be an excellent medium for microbial growth. Improper preparation or packaging of space flight foods could rapidly lead to a contaminated food supply and the potential of food-borne illness. Environmental microorganisms on surfaces are transported by normal activities in a spacecraft. Microorganisms can proliferate against fluid flow directions, through ventilation or water systems that do not have microbial control, and even when exposed to microbial disinfectants. Biological payloads can also be affected by bacteria from the crew, as well as contaminate the crew.

Physical contamination may include non-reactive dirt, dust, metal shavings, broken glass, and other particulates that may present a hazard to the crew. While great efforts are made to minimize foreign object debris, its presence is common when new modules are first entered on orbit. During the Apollo Program, lunar dust became a problem because of contact with both the crew and hardware. It was reported that lunar dust became embedded in the spacesuit zippers and O-rings, making them difficult to operate. Debris in the Orbiter crew compartment of early Shuttle missions caused crew health concerns and physiological discomfort (i.e., crew eye

problems, inhalation of debris, and congestion) and failure or problems with hardware (i.e., computer failures, and blockage of hardware). Contamination was due to the following: poor vehicle and ground support equipment materials selection and application; lack of adequate entryway cleaning of shoes and garments and control; insufficient ground cleaning; inappropriate control of crew clothing and cleaning of debris from the clothing; and problems with inadequate filtering on avionics and other hardware items. Debris from flight was analyzed, quantized, and evaluated to determine its source. After ground turnaround operations at Kennedy Space Center and Palmdale were reviewed from a facility, materials use, and materials control standpoint, and debris analysis provided results, extensive efforts were made to minimize contamination prior to return-to-flight of STS-26 in 1988. This resulted in very clean vehicles. Attention to matters such as these needs to be made to minimize spacecraft contamination. (Goodman & Villarreal, 1992).

6.4.3 Contamination Hazards

The effects of exposure to contamination hazards can vary in type and severity, and depend on the mode of contact with the crew.

Contact exposure to chemicals can cause injury to the skin and eyes, inhalation can damage the lungs, ingestion can damage the digestive tract, and any method of exposure can have a systemic effect that could be hazardous depending on the chemical and amount.

The impact of crew exposure to biological contamination may include infection and illness. One result of microbial contamination is food poisoning, which can cause symptoms such as nausea, vomiting, and diarrhea. In certain circumstances, food poisoning can be fatal.

Physical contaminants can become irritants to the eye, cause irritation and lacerations to skin, or can affect the physical properties of equipment (this was an effect of lunar dust on the Apollo EVA suit), which can ultimately affect crew health and performance.

6.4.4 Contamination Monitoring and Control

The ability to monitor and control contamination (including cross-contamination) largely depends on the source of exposure – the atmosphere, potable water, food, or spacecraft or payload surfaces – and on the built-in systems for management of contamination. Exposures are generally controlled by such measures as layers of containment, filtration, housekeeping, and biocides. When the level of contamination exceeds the normal bounds of the environmental control systems, then the crew could be harmed by exposures. In many cases, the crew can use PPE to control the exposure of individuals to harmful contaminants.

Atmospheric chemical contamination can be very hazardous since it can quickly affect the entire habitable volume of a spacecraft. The ability must exist for the crew to quickly protect their skin, eyes, and lungs; then identify a chemical release, control the release, and remove the contaminants; and then monitor the atmosphere to ensure it is safe to breathe again. If biological contamination of the air occurs, the air can act as a transport medium. Biological contamination usually thrives on reaching a moist surface, food, or water. Physical contamination of the air is almost exclusive to the microgravity environment, where any type of particle can become, and remain, airborne. However, small particles such as lunar dust may be a problem in lunar gravity as well. Because physical contamination can come from many different sources, monitoring is often not practical. Control of particulate material is achieved primarily by circulating and

filtering the air. However, in cases such as glass breakage or loss of containment of another type of material, immediate protection and remediation is necessary, and may require the use of a vacuum.

Contamination of water can be biological, chemical, or physical. Biological contamination can occur from crew or other biological contact with water-dispensing valves or during system repair. It can also occur if the method of microbial control does not continue to function, as when a filter is breached or microorganisms develop resistance to a disinfectant. Chemical contamination of water could occur from capture of contaminated humidity condensate, leaching of water system materials into the water, or failure in the operation of the water purification system. The result could affect crew health directly, or affect the palatability of the water, causing the crew to drink less water, which would indirectly affect crew health. Chemical contamination of surfaces could occur during a spill, and may or may not be visible. Physical contamination could occur as a result of broken systems introducing particulates into the water.

Food can be contaminated chemically, physically, or biologically. Historically, these types of contamination are minimized through careful preflight processing and random sampling of food lots for analysis. Thus, the risk of food contamination during a flight is minimal; however, appropriate packaging, preparation, and monitoring must be maintained because of the severe consequences associated with food contamination, such as food poisoning and infectious disease.

Biological contamination of surfaces may occur in areas of high condensation and exposure to contaminants such as those from food and waste. Proper thermal control and air movement can help to prevent some condensation. Biological contamination is often visible as discoloration of materials. Most importantly, surface contamination must be cleaned and controlled with proper cleaning materials and practices.

Minimizing the possibility of crew contact with contamination of any type is achieved by first limiting its use in the spacecraft. In some cases, this is not possible or feasible, and some potentially hazardous elements need to be used. Providing redundant levels of containment is the next consideration for minimizing contact, to ensure that even if one or more levels of containment fails, the crew is still protected. Although operational procedures can be used to avoid contact with materials, design solutions should be investigated first.

Monitoring contaminants, especially during flight, can be difficult. Thus most chemical, physical, or biological agents are not monitored continuously. Certain agents are used as indicators of other potential contaminants. For example, compounds such as carbon monoxide indicate a potential fire. The presence of coliform bacteria in potable water has been used to indicate the potential presence of medically significant microorganisms in potable water. To quickly identify potential contaminants within the spacecraft, all toxicological and environmental hazard information (e.g., Material Safety Data Sheets [MSDS]) must be accessible to the crew throughout the mission. The potential modes of contamination and their methods of monitoring and control are discussed further in the following sections:

- 6.2.4 Atmosphere Contamination
- 6.3.2.1 Water Contamination
- 7.4 Body Waste Management
- 7.6 Medical
- 7.12 Housekeeping

To restore a contaminated spacecraft to a safe environment, materials must be available to clean the contaminated surfaces, such as the previously mentioned ISS Crew Contamination Protection Kit. The type of materials needed will depend on the type of contamination and the hazard level.

6.4.5 Biological Payloads

Biological materials are classified as nonhazardous and biohazardous. Biohazardous materials may include bacteria, fungi, protozoa, viruses, cell cultures, recombinant DNA, and others. Plants, animals, and some inanimate objects may also be vectors of biohazardous agents.

For space flight applications, biohazardous materials are defined in Table 6.4-1. Because of the unique environment and conditions associated with space flight, Biosafety Level-2 (BSL-2) agents are divided into two classes, BSL-2 (Moderate Risk) and BSL-2 (High Risk) agents. This represents a break from the classification system used by the Centers for Disease Control and Prevention / National Institutes of Health guide and the World Health Organization manual. However, because of the microgravity conditions, aerosols of microorganisms can be more of a risk factor than under Earth gravity (1g). Larger particles and droplets can be suspended as aerosols for longer periods than at 1g. In addition, BSL-3 and BSL-4 agents are not allowed on crewed spacecraft because of the dire health consequences.

Table 6.4-1 NASA In-flight Biosafety Levels (JSC 63828)

	BSL	Description
Allowed	1	Agent not known to cause disease in healthy adults.
	2 (moderate)	Moderate-risk agents associated with human disease.
	2 (high)	Higher risk agents associated with human disease. Risk is increased by larger amounts of agent, lower infectious dose required, likelihood of aerosolization, and other factors.
Not allowed	3	Agents with potential for airborne transmission. May cause life-threatening disease.
	4	Agents with high potential for life-threatening disease. High potential for aerosol transmission of agent with no prophylactic or specific therapy.

6.4.6 Research Needs

RESERVED

6.5 ACCELERATION

6.5.1 Introduction

This section addresses the design considerations for ensuring crew health during translational and rotational accelerations. Additional discussions regarding the use of displays and controls during acceleration can be found in chapter 10, “Crew Interfaces.” The acceleration environments experienced during a space flight have the potential to cause illness and injury, as well as affect crew performance. The effect of acceleration on crewmembers depends on the type (translational or rotational), duration (sustained or transient), and direction with respect to the crewmember (i.e., through the head, chest, or shoulders) of the acceleration.

- Sustained accelerations, translational or rotational, are events with a duration of greater than 0.5 seconds.
- Transient accelerations, translational or rotational, are events with a duration of less than or equal to 0.5 seconds.

The magnitude of the inertial resultant to whole-body acceleration is expressed in multiples of the magnitude of Earth’s gravity, $g = 9.80665 \text{ m/sec}^2$. The capital letter G is used to express the direction of the inertial resultant to whole-body acceleration, as shown in Table 6.5-1.

Table 6.5-1 Inertial Resultant of Body Acceleration

Translational Motion	Physiologic Descriptive	Physiologic Standard	Vernacular Descriptive
Forward	Transverse G, chest to back	+G _x	Eyeballs-in
Backward	Transverse G, back to chest	-G _x	Eyeballs-out
Upward	Positive G	+G _z	Eyeballs-down
Downward	Negative G	-G _z	Eyeballs-up
To the right	Lateral G	+G _y	Eyeballs-left
To the left	Lateral G	-G _y	Eyeballs-right

Historically, NASA capsule vehicle landing loads were primarily +G_x (eyeballs in) and +G_z (eyeballs down). The +G_x component was primarily due to vertical velocity of the vehicle and was dependent on parachute performance. In the case of a two-parachute landing, the vertical velocity would be higher, resulting in a higher +G_x load. The +G_z component was driven by two factors. First, the horizontal wind speed affected the horizontal velocity. At high wind speeds, the +G_z load was much higher. Second, each vehicle was designed with a set hang angle, tilting the entire capsule so that the toe of the vehicle contacted the water first. Even with no horizontal wind, this hang angle would impart a +G_z axis load based on the vertical velocity (see Figures 6.5-1 and 6.5-2). In addition, wave slope during water landings, and terrain slope during land landings, contributed to the effective impact angle.

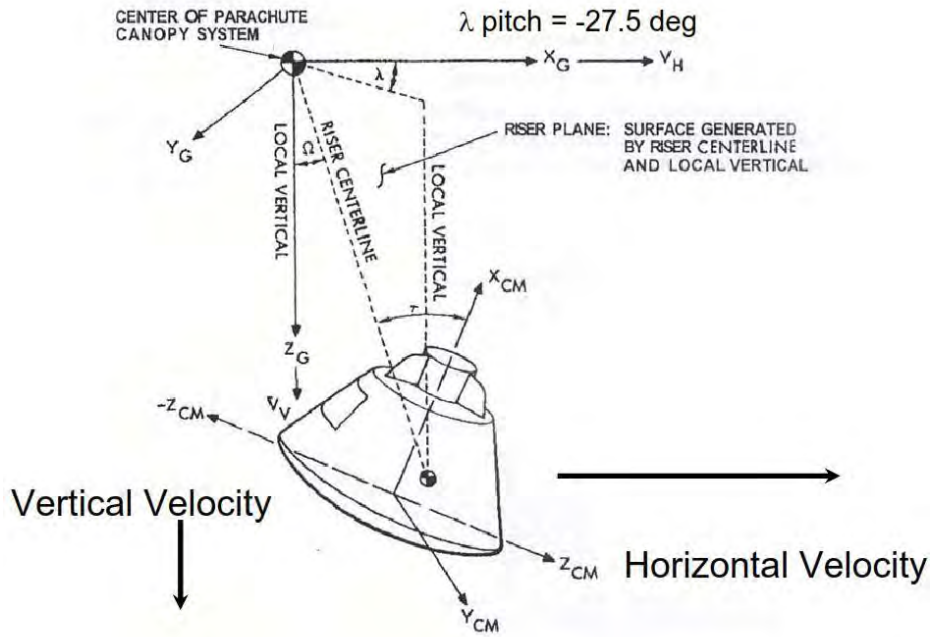


Figure 6.5-1 Example of the Apollo hang angle (adapted from Whitnah & Howes, 1971)

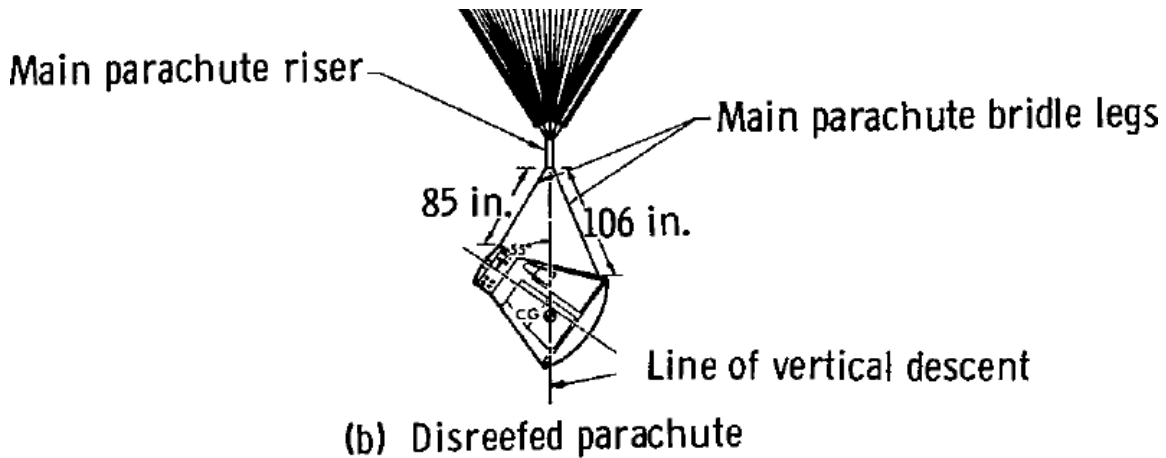


Figure 3. - Main parachute assembly.

Figure 6.5-2 Example of the Gemini hang angle (Adapted from Vincze, 1966)

Although these vectors were primary to the landing load, the loading directions were dependent on the vehicles contacting the water in a particular orientation, which required a roll control system on board to maintain this orientation. Without the roll control system, the vehicles could

rotate on impact (due to the hang angle), imparting loads in other directions. The landing loads may be quite complex, necessitating consideration of the entire vehicle dynamics.

6.5.2 Rotational Velocity and Acceleration

6.5.2.1 Rotational Velocity and Acceleration Regimes

Low-level rotational motion may be encountered during orbital maneuvers, but high-level rotations that are of concern for crew health and performance will typically occur only in off-nominal events such as loss of spacecraft control or aborts. The rotational motion environment must be assessed in terms of both angular acceleration (α) and angular velocity (ω). Rotational motion in space operations, encountered about an arbitrary axis, has been of the magnitudes shown in Table 6.5-2.

Table 6.5-2 Angular Motion During Space Flight

Spacecraft Motion	Angular Velocity and Acceleration
Orbital Maneuvers	α - up to approximately $1.5^\circ/s^2$ (0.026 rad/s ²)
	ω - up to approximately $34.4^\circ/s$ (0.6 rad/s)
Ascent, Entry, or Emergency Abort Maneuvers	α - in excess of $10^\circ/s^2$ (0.18 rad/s ²)
	ω - in excess of $360^\circ/s$ (6.28 rad/s)
Escape Maneuvers	α - in excess of $5,730^\circ/s^2$ (100 rad/s ²)
	ω - up to $720^\circ/s^2$ (12.6 rad/s ²)

6.5.2.2 Effects of Rotational Motion on Humans

Tolerance to rotational motion should be considered in terms of both rotational acceleration and rotational velocity. For spacecraft occupants, the translational and angular motion must be assessed at each occupant's location in the spacecraft. Also, the effects of the angular component of occupant motion will vary with superimposed translational acceleration.


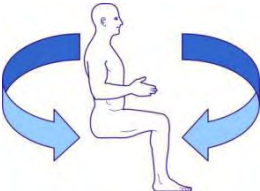
For rotational acceleration that occurs without translation, the most significant acute effects for humans can be assessed by considering the acceleration experienced at the head, recognizing that a dramatic acceleration gradient may exist.

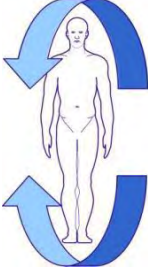
Tolerance to rotational acceleration depends on the interaction of at least three factors: 1) center of rotation with respect to the body, 2) axis of rotation (pitch, yaw, roll), and 3) the rotation rate.

Effects can vary greatly depending on the axis, direction, and rate of motion. During the Gemini VIII mission, a stuck thruster caused a left roll and yaw for several minutes, with the capsule reaching $300^\circ/s$ (50 rpm) for 46 seconds (Mohler et al., 1990). The crewmembers were dizzy and their vision was blurred and near the point of blackout, making it difficult to see the overhead panel dials. They were able to recover from the spin, but the stuck thruster and recovery used a large amount of fuel, resulting in early mission termination.

Table 6.5-3 summarizes what is known about the effects of different types of rotational motion on humans at different exposure levels.

Table 6.5-3 Effects of Rotational Motion on Humans

Rotation Axis	Exposure Levels	Effects on Most Individuals
Any axis	6 rpm	Most individuals without previous experience can tolerate this rotation in any axis or combination of axes
	> 6 rpm	Most individuals rapidly become sick and disoriented unless carefully prepared by a graduated program of exposure
	12 to 30 rpm	Most individuals cannot initially tolerate rotation
	random tumbles	Severe disorientation; reach and manipulative performance degradation ultimately interfere with the ability to make corrective actions
Pitch 	6 rpm	Some individuals have endured 60-minute runs
	80 rpm	Generally intolerable; with the center of rotation at heart level, symptoms of backward acceleration ($-G_x$) are demonstrated and are tolerable for only a few seconds
	90 rpm	Some effects of forward acceleration ($+G_x$), namely numbness and pressure in the legs, are also observed but develop slowly, with pain. No confusion or loss of consciousness is found, but in some individuals, disorientation, headache, nausea, or mental depression are noted for several minutes after a few minutes of exposure
	160 rpm	Unconsciousness from circulatory effects alone occurs after 3–10 seconds with the center of rotation at the heart
	180 rpm	Unconsciousness from circulatory effects alone occurs after 3–10 seconds with the center of rotation at the iliac crest (hip bone)
Yaw 	60 to 90 rpm	When the head and trunk are inclined forward out of the z-axis, rotation becomes close to limiting for 4 minutes, although some motivated individuals have endured 90 rpm in the same mode. Except for unduly susceptible individuals, tolerance tends to improve with exposure
	90 to 100 rpm	Intolerable

Rotation Axis	Exposure Levels	Effects on Most Individuals
<p style="text-align: center;">Roll</p> 	TBD	

6.5.2.3 Rotational Velocity and Acceleration Exposure Limits

To protect against severe discomfort and disorientation, sustained rotational accelerations must not exceed $115^\circ/s^2$ in yaw, pitch, or roll. Much higher rotational acceleration levels may be tolerable for brief exposures. Most studies on the effects of high rotational acceleration rates focus on the resulting head impact after rotation. One study suggests a tolerance level to rotational accelerations in the sagittal plane in the forward direction of approximately $10,000 \text{ rad/s}^2$ for pulse durations shorter than 10 ms, and decreasing for longer pulse durations (Depreitere et al., 2006). The cause of injury in this study was rupture of the bridging vein in the brain after head impact.

Rotational velocities in yaw, pitch, and roll must not exceed the limits specified in Figure 6.5-3. These rotational limits apply for centers of rotation at the heart or outside the heart. However, for rotations outside the heart, the translational accelerations induced at the heart (by rotational accelerations and velocities) must be included in the translational accelerations.

The data in Figure 6.5-3 apply when crewmembers are appropriately trained and restrained and use acceleration protection. The figure presents three limiting conditions:

- The **solid red line** represents the maximum level of sustained acceleration allowed on a crewmember during a launch abort or emergency entry. Under these extreme conditions, it may be necessary to expose the crew to accelerations more severe than those experienced nominally (blue lines), but crewmembers must never be exposed to accelerations greater than those depicted by the solid red lines in the charts. Exceeding these elevated limits could significantly increase the risk of crew incapacitation, thereby threatening crew survival. Each axis should be analyzed separately, and conservatism in the limits for each axis covers any cumulative effect of acceleration in multiple axes.
- The **dashed blue line** represents the maximum level of sustained acceleration exposure for a conditioned crewmember under nominal conditions. Exposure to g forces greater than these limits could significantly affect human performance for maneuvering and interacting with the spacecraft. Each axis should be analyzed separately, and conservatism in the limits for each axis covers any cumulative effect of acceleration in multiple axes. Staying within these limits allows crewmembers the ability to read

displays, communicate, and perform gross motor skills with upper extremities (e.g., switch throws).

- The **dotted green line** represents the maximum level of sustained acceleration exposure for a crewmember, after sustained exposure to a reduced or 0g environment, after an injury, or during an illness. After working at the mission destination, crewmembers could have degraded capabilities because of the pathophysiology of being deconditioned from exposure to reduced gravity, and therefore must not be exposed to accelerations greater than those depicted by the dotted green lines in the charts. Greater exposure to g forces could significantly affect human performance and safety. The lower dotted green limits also accommodate returning ill or injured crewmembers. Each axis should be analyzed separately, and conservatism in the limits for each axis covers any cumulative effect of acceleration in multiple axes.

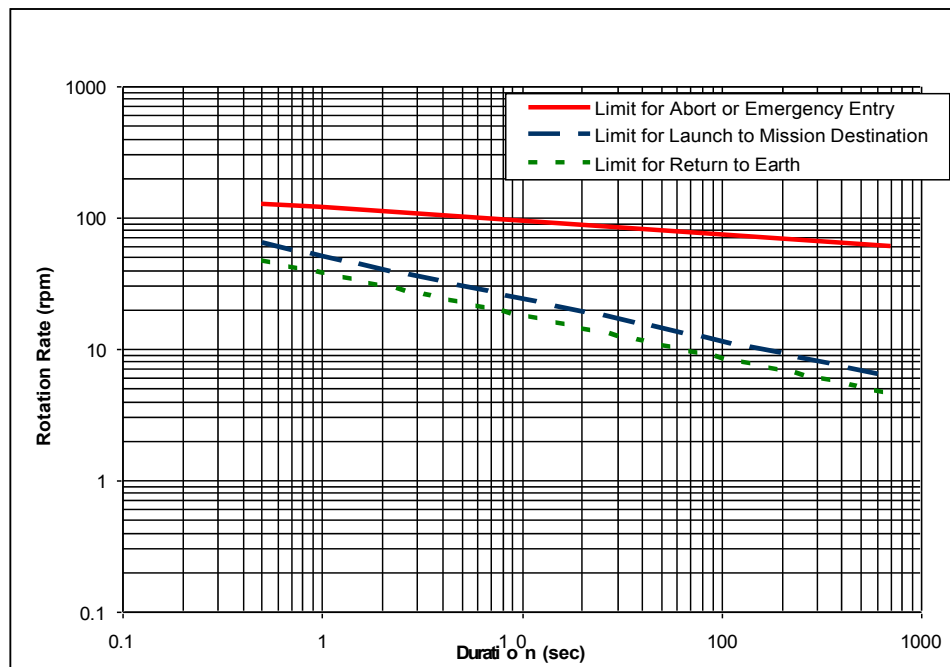


Figure 6.5-3 Angular velocity limits.

6.5.2.4 Countermeasures for Rotational Velocity and Acceleration

Depending on the magnitude and duration of the rotational motion, countermeasures may include the use of a g-suit to prevent excessive peripheral blood flow, restraints to prevent flailing, and minimizing head movement to reduce Coriolis stimulation of the vestibular system, which could cause severe disorientation.

6.5.3 Sustained Translational Acceleration

6.5.3.1 Sustained Translational Acceleration Regimes

For space systems, sustained translational accelerations include those in Table 6.5-4.

Table 6.5-4 Sustained Translational Acceleration Regimes

Gravity / Acceleration	Location	Values Observed
0g	<ul style="list-style-type: none"> • Orbit • Interplanetary flight 	Approximately 10 ⁻⁶ to 10 ⁻¹ g, omnidirectional
Partial gravity (hypogravity)	Planetary surfaces	<1g: <ul style="list-style-type: none"> • 0.17g on the Moon • 0.38g on Mars
Earth gravity	Earth surface	1g
Hypergravity	<ul style="list-style-type: none"> • Launch • Entry 	>1g: <ul style="list-style-type: none"> • 3g maximum in Shuttle launch • 1.5g in Shuttle during entry (for up to 17 minutes) • 6.4g in Mercury launch (for 54 seconds) • 7.6-11.1g in Mercury entry • 6g in Gemini launch (for 35 seconds) • 4.3-7.7g in Gemini entry • 4g maximum in Apollo launch • 8g in Apollo entry

6.5.3.2 Effects of Sustained Translational Acceleration on Humans

Space flight can create significant changes in the cardiovascular system. These changes begin on the launch pad and continue on orbit, but are usually of most concern during entry and landing, when astronauts are reintroduced to gravity and acceleration.

The 0g environment causes cardiovascular deconditioning due to the reduced load on the heart and vasculature because the heart does not need to pump blood against gravity and physical workload is markedly reduced. In addition, a headward fluid shift occurs in 0g, which the body perceives as an increase in fluid pressure and mitigates by eliminating fluid from the vasculature. This results in an overall decrease in blood plasma volume in 0g. Although the body's adaptation is appropriate for the 0g environment, it is maladapted for reexposure to gravity and acceleration. During entry on the Shuttle with the crew seated upright, the body's fluid is pulled downward toward the legs; however, with reduced blood volume and diminished cardiovascular capacity, hypotension can occur, which is the primary cause for gravity-induced loss of consciousness (G-LOC). G-LOC is often preceded by visual symptoms progressing from tunnel

vision to grey-out before complete blackout, and is accompanied by deficits in motor and cognitive function. If not mitigated, these problems can create a dangerous situation during flight, reducing the ability of the crew to perform piloting tasks. While it has not been an issue for space flight to this point, the potential for G-LOC should still be considered, especially when astronauts are returning from planetary missions under higher entry decelerations than are encountered during orbital flights such as the Space Shuttle. Shuttle entry forces do not exceed 1.5g, but they last up to 17 minutes and are much more provocative than normal due to the cardiovascular deconditioning caused by adaptation to 0g.



Sustained translational acceleration can also cause injury, depending on the magnitude, duration, and relative direction. During the Soyuz-18A launch in 1975, failure of a third-stage booster to separate exposed the crew to 20.6g during entry, and resulted in internal injuries. A pad fire occurred before the Soyuz T-10A launch in 1983 and the Launch Escape System was activated. The crewmembers experienced 14 to 17g for 5 seconds, but they were not injured.



Also of great concern for returning from space flight is orthostatic intolerance, which is characterized by a variety of symptoms that occur on standing, including lightheadedness, increase in heart rate, altered blood pressure, and fainting. Without proper countermeasures, this condition would make rapid egress from the spacecraft difficult.


Sustained translational acceleration is also associated with effects on the vestibular system. Stimulation of the otoliths in the inner ear can create disorienting sensations when the head is tilted in flight. When a person moves the head in hypergravity, an otolith signal is generated. That signal corresponds to a greater change in attitude than has actually occurred. Nausea, vertigo, sensations of tumbling, as well as an apparent change in attitude, can also be evoked by a head movement during acceleration. These effects are even more pronounced on return from space flight, due to increased sensitivity of the vestibular otoliths that results from adaptation to 0g. For additional information on the effects of acceleration on the vestibular system, see section 5.3, "Sensorimotor Function."

The following is a summary description of the combined human responses to specific sustained translational acceleration vectors in a relaxed, unprotected individual adapted to Earth's gravity. It is important to note that physiological effects of sustained acceleration will be exaggerated for 0g-adapted astronauts returning from space, and will occur at lower thresholds, which is not taken into account below. It is unclear how adaptation to partial gravity, such as on the Moon or Mars, might affect acceleration tolerance. Accelerations may be accompanied by complex oscillations and vibrations. It is important to note that the physiological effects described below depend on the onset rate (gradual onset < 1g/s; rapid onset 1–2g/s; very high onset > 6g/s). The information in Table 6.5-5 is derived mainly from studies involving gradual onset exposures (Kumar and Norfleet, 1992).

Table 6.5-5 Physiological Effects of Sustained Translational Acceleration

 <p>Effects of Sustained +G_z Acceleration (eyeballs down)</p>	
+1g	Equivalent to the erect or seated terrestrial posture
+2 to +2.5g	Increased weight; increased pressure on buttocks; drooping of face and body tissues; hypotension; difficult to raise oneself at 2.5g
+3 to +4g	Impossible to raise oneself; difficult to raise arms and legs; movement at right angles extremely difficult; progressive dimming of vision (grayout) after 3–4 seconds; progressive tunneling of vision
+4 to +6g	Total loss of vision (blackout) after about 5 seconds; hearing and then consciousness lost if exposure continued; mild to severe convulsions in about 50% of the subjects after unconsciousness, frequently with dreams; occasionally paresthesias (abnormal nerve sensations, such as tingling or burning); confused states; pain not common, but tension and congestion of lower limbs with cramps and tingling; inspiration difficult; loss of orientation of time and space for up to 15 seconds post acceleration; after unconsciousness, return to purposeful action takes an average of 24 seconds
> +6g	Protection is needed to preserve health
 <p>Effects of Sustained -G_z Acceleration (eyeballs up)</p>	
-1 G _z	Tolerable; sense of pressure and fullness in the head; congestion of eyes
-2 to -3 G _z	Severe facial congestion; bradycardia; dysrhythmia; throbbing headache; blurring, graying, or occasional reddening of vision after 5 seconds; congestion disappears slowly; may leave petechial hemorrhages, swollen eyelids
> -3 G _z	The 5-second tolerance limit is rarely reached; causes mental confusion and unconsciousness

 Effects of Sustained +G_x Acceleration (eyeballs in)	
1G _x	Slight increase in abdominal pressure; respiratory rate increases
+2 to +3G _x	Difficulty in spatial orientation; +2g tolerable for at least 24 hours
+3 to +6G _x	Progressive tightness in chest and abdomen; cardiac rhythm disturbances; loss of peripheral vision; difficulty in breathing and speaking; blurring of vision, effort required to maintain focus; 4g tolerable up to at least 60 minutes
+6 to +9G _x	Chest pain and pressure; shallow respiration from position of nearly full inspiration; decreased oxygen uptake during acceleration; pulmonary vascular pressures increase toward dorsal part of chest and fall in alveolar pressure on the ventral part; arterial oxygen saturation falls below 85%, which can lead to cognitive impairment; further reductions in visual acuity and depth perception, increased blurring, occasional tunneling, great concentration required to maintain focus; occasional lacrimation (tears); body, legs, and arms cannot be lifted at +8g; head cannot be lifted at +9g; precise manual control compromised
+9 to +12G _x	Increased severity of symptoms; severe breathing difficulty, increased chest pain, marked fatigue, loss of peripheral vision, diminution of central acuity, lacrimation
> +12G _x	Extreme difficulty in breathing and speaking, severe viselike chest pain, loss of tactile sensation; total loss of vision possible
 Effects of Sustained -G_x Acceleration (eyeballs out)	
All levels	Similar to those of forward acceleration with modifications produced by reversal of the force vector; pulmonary vascular pressures reversed from those in +G _x ; total body restraint system is critical and has a direct relationship to the ability to tolerate rearward acceleration exposures

	Effects of Sustained +/- Gy Acceleration (eyeballs left/right)
+/-1 to 2G _y	Difficulty maintaining head and shoulders upright without restraints; difficulty of precise manual control
+/-3G _y	Discomfort after 10 seconds; pressure on restraint system; feeling of supporting entire weight on clavicle; inertial movement of hips and legs; yawing and rotation of head toward shoulder; petechiae and bruising; engorgement of dependent elbow with pain; total body restraint system is critical
+/-5G _y	Conjunctival hemorrhage has been reported; severe headache after exposure

6.5.3.3 Sustained Translational Acceleration Exposure Limits

The maximum translational sustained acceleration limits shown in Figures 6.5-4 through 6.5-8 must be met (Eiband, 1959).

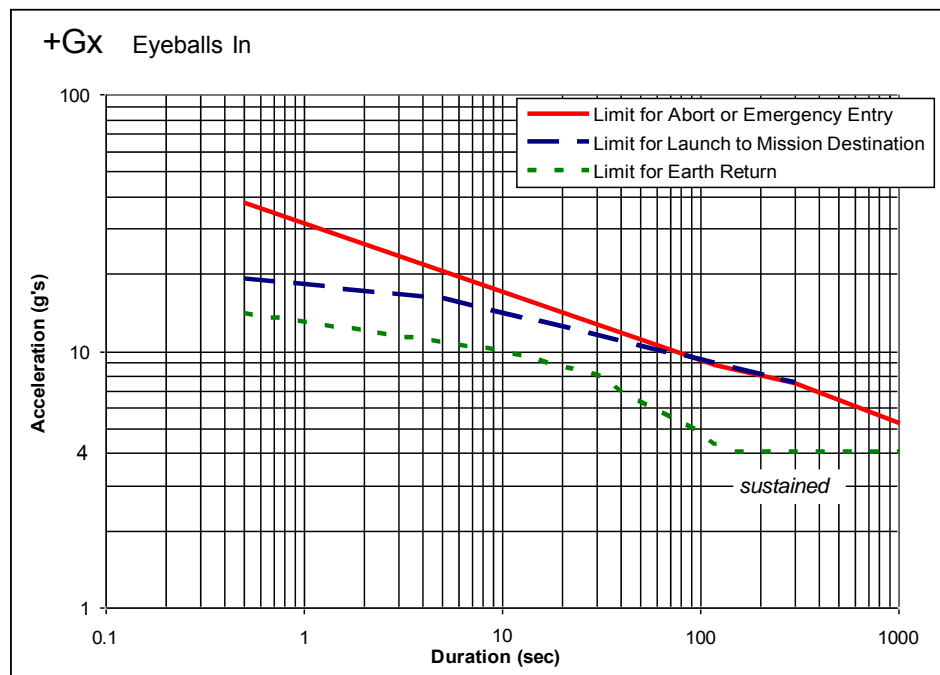


Figure 6.5-4 +G_x sustained or short-term plateau translational acceleration limits.

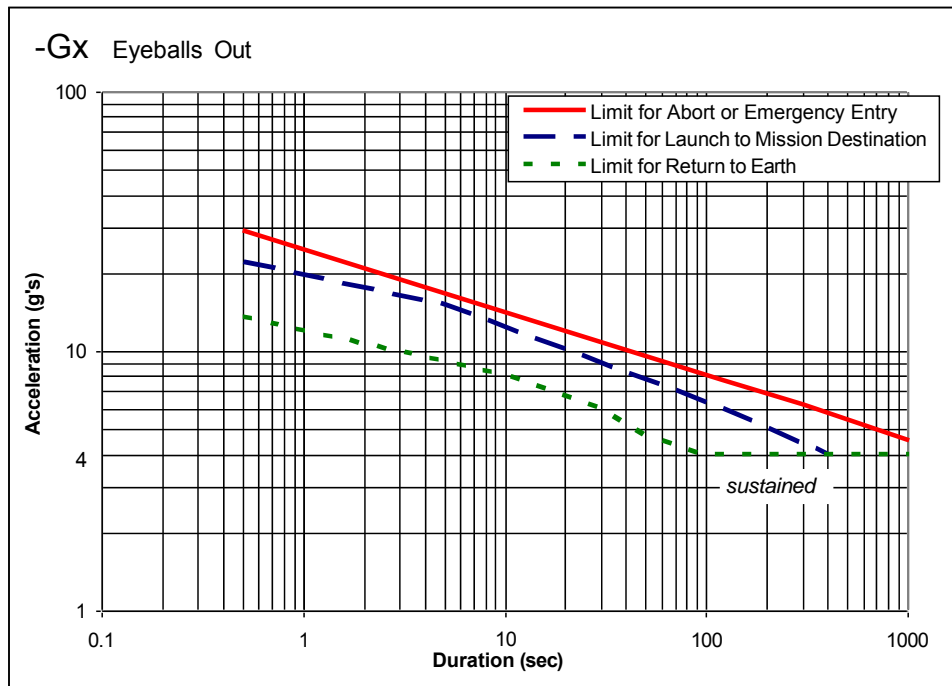


Figure 6.5-5 $-G_x$ sustained or short-term plateau translational acceleration limits.

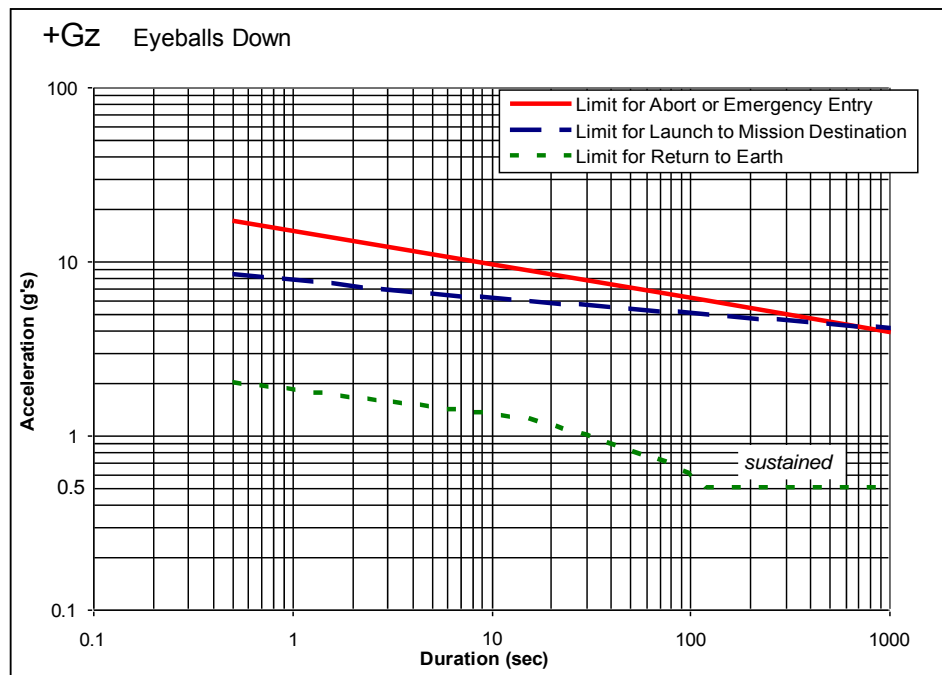


Figure 6.5-6 $+G_z$ sustained or short-term plateau translational acceleration limits.

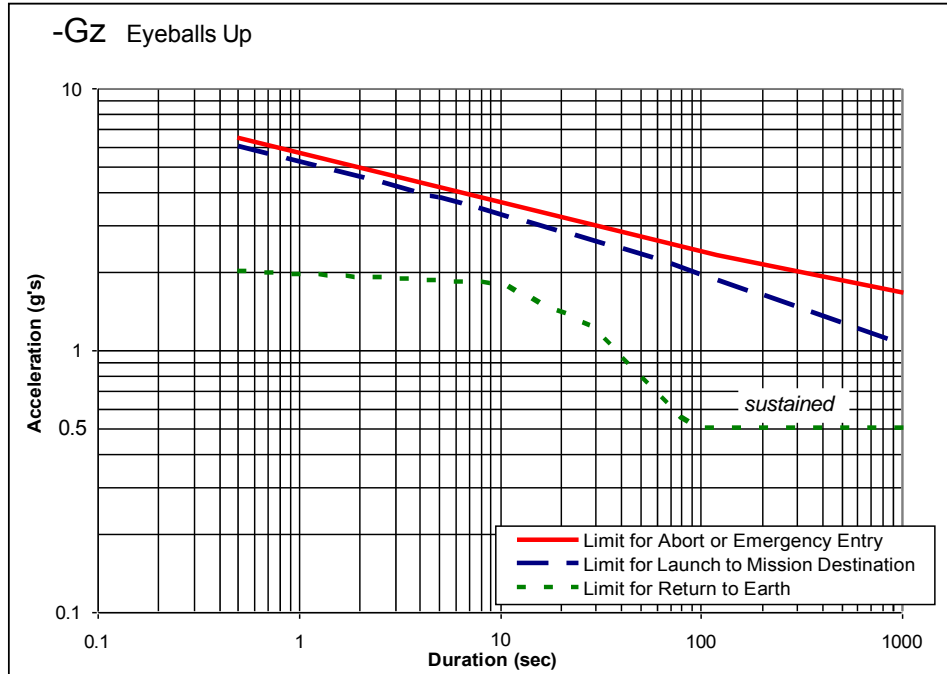


Figure 6.5-7 $-G_z$ sustained or short-term plateau translational acceleration limits.

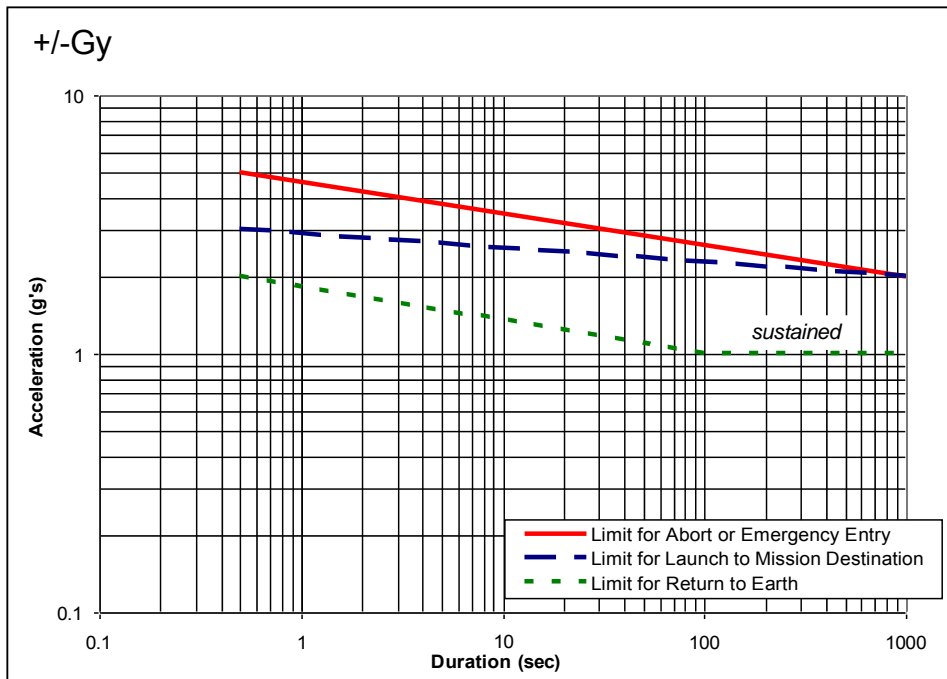


Figure 6.5-8 $\pm G_y$ sustained or short-term plateau translational acceleration limits.

When using Figures 6.5-4 through 6.5-8, translational accelerations induced by rotational accelerations or velocities outside the heart should be considered (see text supporting Figure 6.5-3 for description of red, blue, and green line). The data in these figures apply when the crewmembers are appropriately trained and restrained and use acceleration protection.

As shown by the acceleration limits above, humans can withstand higher accelerations for longer durations in the +G_x direction. Therefore, positioning the crew to take the higher accelerations through the chest is one of the key considerations for meeting these limits. Depending on the spacecraft design and the phase of flight in which high accelerations are encountered, this may result in a recumbent position, with crewmembers tilted back with respect to the velocity vector, which is how long-duration crewmembers aboard the ISS returned on the Space Shuttle.

To reduce the risk of incapacitation, the crew must be prevented from being exposed to a rate of change of acceleration of more than 500 g/s during any sustained acceleration event.

6.5.3.4 Countermeasures for Sustained Translational Acceleration

In addition to meeting the preceding acceleration guidelines to ensure crew safety, consider the following countermeasures, especially if expected accelerations may be near the limits:

- Anti-g suit (AGS) – The AGS, which is part of NASA’s ACES that were worn by Space Shuttle astronauts, is used to prevent G-LOC and related concerns. An AGS provides positive pressure to the lower torso, preventing blood from pooling in the legs, and may also help to increase venous return. Venous occlusion and discomfort may be problematic. Studies show that although the AGS is good for short-duration g exposure, it may actually decrease tolerance for durations greater than several seconds (Tripp, 2007). The United States Air Force developed improvements in the AGS. These improvements provide increased protection for more body area and the ability to more quickly adjust to a changing g force:
 - Combined Advanced Technology Enhanced Design G-Ensemble (COMBAT EDGE, or CE) – incorporates positive-pressure breathing to reduce the fatigue associated with the anti-g straining maneuver (AGSM) and a chest bladder/vest to increase intrathoracic pressure to prevent lung overinflation. However, the additional body surface coverings of the CE vest have anecdotally been reported to substantially increase body temperature and fluid loss, notwithstanding research that indicated no such increased thermal stress occurs (Balldin et al., 2002). In response to such complaints of thermal stress when wearing the CE vest, Balldin et al. (2005) showed that the vest is not necessary to enable increased g tolerance.
 - Advanced Tactical Anti-g Suit – is a fully inflatable trouser that covers the entire leg. It is used together with CE by Air Force F-22 pilots.
 - Libelle G-Multiplus – is a fluid-filled, total body suit that capitalizes on the counter-pressure of the fluid against the body during acceleration to maintain blood flow to the head. Unique advantages of the Libelle suit may be its near-instantaneous reaction to changing g-force, its elimination of the need for an AGSM, its allowance for continual ease of extremity movement, and reduction in upper-arm pain under acceleration. The liquid suit technology may also offer improved heating and cooling properties for the crewmember. However, some complaints about the Libelle suit include a negative training challenge from crewmembers’ past experience with pneumatic suits and reduced anti-g capability compared to advanced pneumatic suits (Eiken et al., 2002).

- Muscle contraction – Straining and tensing muscles raises the G-LOC threshold by constricting the body’s vasculature, thereby preventing blood from traveling away from the head when in an upright position. In some early aircraft experiments, it was found that sustained contraction of all the skeletal muscles increased tolerance by approximately 2g, which is acceptable for short-duration exposures (von Diringshofen, 1942).
- Lower-body negative pressure (LBNP) – LBNP is a potential countermeasure that stresses the cardiovascular system on orbit by creating a controlled pressure differential between the upper and lower body. This mimics 1g in that the heart responds by increasing blood pressure to maintain proper blood flow to the head and upper body. It is possible that periodic exposure to LBNP may reduce the amount of cardiovascular deconditioning, thereby increasing orthostatic tolerance during entry.
- L-1 AGSM – This procedure, which includes muscle contraction and repeating the Valsalva maneuver and a short, deep breath every 3 to 4 seconds, also gives substantial protection by raising blood pressure at head level. However, this procedure tends to be very fatiguing and distracts the pilot from other tasks.
- Positive-pressure breathing – This countermeasure was also found to improve the ability to withstand high, sustained accelerations. Although it is fatiguing, it was shown to be much less so than performing the L-1 maneuver or using an AGS, but it can cause difficulty when trying to communicate.
- Combined AGS, L-1 AGSM, and Positive-Pressure Breathing – The L-1 AGSM used in conjunction with an AGS and positive-pressure breathing seems to provide the best mechanical or physical exertion countermeasure to degraded cognitive function brought on by g-onset (Alberry and Chellete, 1998). The most glaring negative characteristic of this method is its distractiveness and disruptiveness to other crew functions.
- Entry fluid loading – To prevent G-LOC during entry, and orthostatic intolerance upon egress, Shuttle astronauts drink 1-2 liters of high-sodium liquids before entry, to replace the circulating volume that was lost during the flight. In a sample of 26 astronauts, the 17 who practiced “fluid loading” had lower heart rates, maintained blood pressure better, and reported no faintness, compared to 33% incidence of faintness in the 9 astronauts who did not use the countermeasure (Bungo et al., 1985). However, it seems that the effectiveness of fluid loading is reduced as mission duration increases (Charles and Lathers, 1991)
- Pharmacotherapeutics – Certain medications may improve orthostatic intolerance by increasing peripheral vasoconstriction, plasma volume, or cardiac contractility.

In addition, sustained engine burns, such as orbital insertions or translunar injection, may be low in magnitude but have rapid onset and require the crew to be restrained in some manner. Also, the direction of the acceleration with respect to the crew needs to be evaluated. Crews’ facing away from the direction of travel, which could occur in lunar transit, would provide a less tolerable “eyeballs out” acceleration.

The use of artificial gravity during long-duration 0g missions should be considered a preventive countermeasure, to ensure the crewmembers are readapted to the returning gravity environment, such as 1g for Earth and 3/8g for Mars. Artificial gravity may be achieved through rotation of

the spacecraft or a localized onboard centrifuge (Tsiolkovsky, 1954; Lackner and DiZio, 2000). Creating a 1g, or partial-g, environment on a long-duration space flight would mitigate most of the negative effects that weightlessness induces on the cardiovascular, musculoskeletal, and vestibular systems, thereby eliminating many of the design measures proposed to counteract the resulting human constraints. However, numerous challenges are still associated with this technology, and additional research is required before it can be considered a feasible option. If rotation is used to create artificial gravity, consider the following general principles to minimize the effects of rotational acceleration on the human:

- Radial traffic should be kept to a minimum.
- The crewmembers should not traverse the spin axis unless the hub is nonrotating.
- The living and working areas should be located as far as possible from the axis of rotation.
- The compartments should be oriented so that the primary traffic paths are parallel to the spacecraft spin axis.
- Workstation positions should be oriented so that, during normal activity, the lateral axis through the crewmember's ears is parallel to the spin axis. In conjunction with this, the controls and displays should be designed so that left/right head rotations and up/down arm motions are minimized.

Under the Constellation Program, requirements for the Orion vehicle specified that controls used during accelerations above 3 g be operable without reaching, and between 2g and 3g be placed such that operators make control inputs via hand/wrist movements and reaches within a forward +/-30 degree cone. The Orion vehicle was also required to provide stabilizing support for operator limbs during exposure to anticipated accelerations above 2 g for all control tasks. The collection of these requirements led to confusion over whether the need for support was in conflict with the ability to reach forward under 2 g. An interpretation was provided to clarify that, crew action can be performed between 2 and 3 g either by discrete reaches within the 30 degree cone described, or by manual control using a side/wrist controller. The wording of the requirement allows either approach, although rapid reaches are discouraged (i.e., time-critical actions should be via a side-controller). Provision of limb support does not prohibit such reaches. The intent is that proper arm/wrist support be provided to assure that the operation of any side controller is not hampered by g-loading above 2 g, because continuous control actions are vulnerable to inadvertent input. Therefore, between 2 and 3 g, proper support must be available if/when the side controller is used at loadings above 2 g.

6.5.4 Transient Translational Acceleration

6.5.4.1 Transient Translational Acceleration Regimes

Transient translational accelerations, including impacts, are abrupt-onset, short-duration, high-magnitude events. It is generally considered that this type of motion involves principally a transient response for the occupant, of less than or equal to 0.5 second duration. Some transient translational acceleration conditions to which space crewmembers may be exposed are launch spacecraft staging, thruster firing, ejection seat/ejection capsule firings, escape device

deployment, flight instability, air turbulence, and parachute deployment and landing. Aircraft acceleration levels include those listed in Table 6.5-6.

Table 6.5-6 Aircraft Transient Acceleration Levels

Event	Acceleration Levels
Aircraft ejection seat firing	up to 17 G _z *
Crash landing	10g to greater than 100g (omnidirectional)
Violent maneuvers	2 to 6g (omnidirectional)
Parachute-opening shock	approximately 10 G _z

*U.S. Navy Military Specification MIL-S-18471 Rev. G. (Engineering Specifications and Standards Department, 1983)

Apollo capsules hit the ocean water at 9 m/s, whereas the Soyuz hits the ground at approximately 7 m/s. The most severe impact experienced in an Apollo space flight occurred with Apollo 12. It was estimated that the Command Module entered the water at a 20° to 22° angle, instead of the nominal 27.5°, which resulted in a 15g impact. This off-nominal impact occurred when the surface winds caused the spacecraft to swing and meet the wave slope at a more perpendicular angle. Although the 15g impact of Apollo 12 was described as “very hard” by the crew, they experienced no significant physical difficulties (Johnston et al., 1975). Also, one of the three parachutes failed to open for the Apollo 15 landing, resulting in a touchdown at 32 ft/s (9.8 m/s) instead of the nominal 28 ft/s (8.5 m/s), but the crew was unharmed. The impact during a Soyuz landing is approximately 4g. Transitions between launch spacecraft staging events may also include abrupt g loads.

6.5.4.2 Effects of Transient Translational Accelerations on Humans

Many factors affect the likelihood of injury during dynamic flight events, including extrinsic factors such as g loading; velocity change; rate of acceleration onset; acceleration rise time; bone and soft tissue compression, extension, and shear force magnitudes and directions, and deflections of the body components; as well as intrinsic factors of the crew such as age, gender, physical condition, and degree of muscle tension.

Tolerance to impact and shock is usually based on skeletal fracture levels, with damage to the vertebrae the most common injury. Two main factors, combined with the amplitude of acceleration, determine tolerance: 1) duration of exposure to acceleration, and 2) orientation of the body with respect to the direction of acceleration. The human body can withstand the greatest impact loads through the chest (+G_x). Tolerance of humans to impact without serious injury is summarized in Table 6.5-7.

Table 6.5-7 Tolerance of Humans to Impact

Direction	Amplitude	Rate
± G _x (chest)	20g	10,000g/s
± G _y (side)	20g	1,000g/s
± G _z (spine)	15g	500g/s
45° off-axis (any axis)	20g	1,000g/s

However, these tolerances to impact will be reduced after adaptation to 0g, and most likely also for partial-g. The muscles and bones in the lower back, abdomen, and legs that are responsible for maintaining posture and balance are greatly reduced in strength by exposure to weightlessness. Bone loss as high as 20% has been seen in some astronauts after a 6-month flight; this could lead to a significant increase in fracture risk on return to 1g.

Since human tolerance to impact depends on direction, crew position should be considered for reducing the potential for injury, with impact through the axis of the chest providing the greatest protection. For example, for a capsule with a parachute where landing impact and parachute shock can be severe, having crewmembers land while on their backs may be optimal, as was done for Mercury, Gemini, and Apollo, and is still done for Soyuz.

6.5.4.3 Transient Translational Acceleration Exposure Limits

This section contains two proposed occupant protection methods for preserving crew health and safety: the Brinkley Dynamic Response method and a new method NASA is currently examining.

6.5.4.3.1 Brinkley Dynamic Response Method

The Brinkley Dynamic Response Model can provide an injury risk assessment for transient translational accelerations. It has its basis in tests with volunteer subjects, tests using postmortem human subjects, accidental injuries, and injuries incurred during emergency escape from aircraft; it thereby provides point estimates for injury probability based on the acceleration-time histories.

Human testing of aircraft ejection seats and spacecraft seats, as well as operational experience with emergency escape systems, has enabled the highest fidelity for injury prediction using the Brinkley model in the +G_z axis. The probability-of-injury assessments were made on the basis of mean values of groups of replicate tests and operational ejection outcomes. The probabilities were determined by best fit of the mean values to a normal distribution curve and subsequent calculation of 95% confidence intervals for each set of conditions. The 50% probability (P) of injury for +z axis is based on an *n* of greater than 100, yielding 95% confidence interval (P=0.5, n=100) is 0.402 ≤ P ≤ 0.598. Where P=0.11 and n=89, the 95% confidence interval is 0.045 ≤ P ≤ 0.175. The confidence intervals for the +z axis means become smaller for lower risk values (5% and lower; see Table 6.5-8). However, statistical uncertainty remains for the other axes; therefore, the probability of injury is provided as a relative scale as follows.

Table 6.5-8 Approximate Risk Values for the Brinkley Model

<i>Category</i>	<i>Approximate Risk</i>
Low	0.5%
Medium	5.0%
High	50%

These crew injury risk values were developed from experimental data in which the seat occupant was restrained to the seat and seat back by a lap belt, shoulder straps, and a negative-g strap or straps to control pelvic motion (i.e., “submarining of the pelvis”) or from operational escape statistics where similar restraint systems were used (Brinkley et al., 1990). During the

experiments, the restraint system was adequately pre-tensioned to eliminate slack. Pyrotechnically powered inertial reels were used to position escape system occupants and to eliminate slack in the restraint.

The assumptions and criteria required to apply the Brinkley Dynamic Response model are listed below. The Brinkley Dynamic Response model is documented, in further detail, in the Advisory Group for Aerospace Research and Development (AGARD) CP-472 “Development of Acceleration Exposure Limits for Advanced Escape Systems.”

- a. Accelerations less than or equal to 0.5 s (e.g., during liftoff, launch abort, landing impacts, and parachute deployments)
- b. A restraint system that includes, at a minimum, pelvic restraints, torso restraints, and anti-submarining restraints that provide occupant restraint no less than that of a conventional 5-point harness
- c. Adequately pre-tension the restraints to eliminate slack
- d. No gaps between the seat and body (or between the restraints and body, including with the suit inflated)
- e. Seat padding or cushions preclude amplification of transient translational accelerations transmitted to the occupant
- f. Suit may not change the natural frequency or damping of the body
- g. Seat occupant’s head is protected by a flight helmet. Helmet mass must be less than 2.3 kg and must include a liner adequate to pass ANSI Z-90 or equivalent (American National Standards Institute, 1992).
- h. All crew are similarly restrained during all events that might require application of the Brinkley model

If these criteria are met, the Brinkley Dynamic Response model is valid to apply; the injury risk criterion, β , which must be limited to no greater than 1.0, is calculated by

Equation 6.5-1:

$$\beta = \sqrt{\left(\frac{DR_x(t)}{DR_x^{\text{lim}}}\right)^2 + \left(\frac{DR_y(t)}{DR_y^{\text{lim}}}\right)^2 + \left(\frac{DR_z(t)}{DR_z^{\text{lim}}}\right)^2}$$

where $DR_x(t)$, $DR_y(t)$, and $DR_z(t)$ are calculated using the Brinkley Dynamic Response model. The dimensionless dynamic response in each of the three axes is given by

Equation 6.5-2:

$$DR = \omega_n^2 (x/g)$$

where

x is the spring deflection of the dynamic system (consisting of the seat and the body) along each axis and can be found by solving the equation

Equation 6.5-3

$$\ddot{x} + 2\zeta\omega_n \dot{x} + \omega_n^2 x = A$$

where, A is the measured acceleration, per axis, of the seat at the critical point shown in Figure 6.5-9. Since the seat axis is not an inertial frame, rotational acceleration must be considered in terms of the translational components of the angular motion.

g is the acceleration of gravity

\ddot{x} is the occupant's acceleration in inertial frame

\dot{x} is the occupant's relative velocity with respect to the critical point shown in the seat coordinate system in Figure 6.5-9

x is the displacement of the occupant's body with respect to the critical point shown in the seat coordinate system in Figure 6.5-9 (a positive value represents compression of the body)

ζ is the damping coefficient ratio defined in Table 6.5-9

ω_n is the un-damped natural frequency of the dynamic system defined in Table 6.5-9

Table 6.5-9 Brinkley Model Coefficients

	X		Y		Z	
	eyeballs out	eyeballs in	eyeballs left	eyeballs right	eyeballs up	eyeballs down
	$x < 0$	$x > 0$	$y < 0$	$y > 0$	$z < 0$	$z > 0$
ω_n	60.8	62.8	58.0	58.0	47.1	52.9
ζ	0.04	0.20	0.09	0.09	0.24	0.224

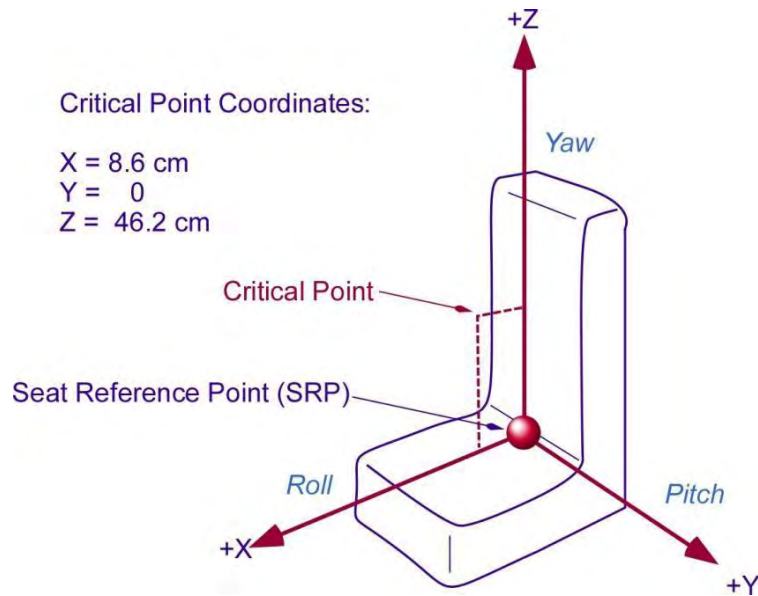


Figure 6.5-9 Critical point definition for seated occupant.

To determine the injury risk criterion, β , as a function of time, do the following:

- a. Find the acceleration at the critical point in each axis at time t .
- b. Solve the second-order differential equation for the displacement (x) of the occupant (Equation 6.5-3).
- c. Determine the dynamic response ($DR(t)$) for each axis at time t using Equation 6.5-2.
- d. Begin with the Low DR limits that apply (either deconditioned or non-deconditioned) from Table 6.5-10.
- e. Calculate β using the Low DR limits and the dynamic responses at each time point using Equation 6.5-1.
- f. Increment time and repeat until the maximum β is found.
- g. If β is less than or equal to 1.0, then the acceleration meets the Brinkley Low criteria. If the maximum β is found to be greater than 1.0, select the applicable medium DR limits from Table 6.5-10 and repeat steps 5 & 6.
- h. If β is less than or equal to 1.0, then the acceleration meets the Brinkley medium criteria. If the maximum β is found to be greater than 1.0, select the applicable High DR limits from Table 6.5-10 and repeat steps 5 & 6.
- i. If β is less than or equal to 1.0, then the acceleration meets the Brinkley High criteria. If the maximum β is found to be greater than 1.0, the acceleration exceeds the Brinkley High Criteria.

Table 6.5-10 Dynamic Response Limits

DR Level	X		Y		Z	
	Eyeballs out	Eyeballs in	Eyeballs left	Eyeballs right	Eyeballs up	Eyeballs down
	$DR_x < 0$	$DR_x > 0$	$DR_y < 0$	$DR_y > 0$	$DR_z < 0$	$DR_z > 0$
Low (Deconditioned)	-28	35	-15	15	-11.5	13.0
Low (Non-Deconditioned)*	-28	35	-15	15	-13.4	15.2
Medium (Deconditioned)	-35	40	-20	20	-14.1	15.4
Medium (Non-Deconditioned)*	-35	40	-20	20	-16.5	18.0
High (Deconditioned)	-46	46	-30	30	-17.5	19.5
High (Non-Deconditioned)*	-46	46	-30	30	-20.4	22.8

The table values assume lateral supports are used (limiting side body movement).

* Use for healthy, non-deconditioned crew (e.g., launch abort cases).

Table values were derived based on a review of the following: AGARD CP-472, NASA-TM-2008-215198, NASA-TN-D-7440, and NASA-TN-D-6539 (Brinkley, et al., 1990; Lawrence, et al., 2008; Drexel & Hunter, 1973; Thomas, 1971)

In this model, it is assumed that the total body mass that acts on the vertebrae to cause deformation can be represented by a single mass.

Using the Dynamic Response Model limits for accelerations of less than or equal to 0.5 s (e.g., during nominal liftoff, launch abort, landing impact, and parachute deployment) provides the proper margins of safety for a healthy deconditioned crewmember. The Dynamic Response Model will provide an injury risk assessment in the event of a nominal or an off-nominal failure or multiple failures. The desired dynamic response limits are low (approximately 0.5%) for all cases. If occupant protection principles are not properly applied, and/or multiple off-nominal failures occur, loads could impart risks in the medium risk (approximately 5%) and high risk categories (approximately 50%) for risk of sustaining a serious or incapacitating injury.

6.5.4.3.2 New NASA Method for Occupant Protection

NASA is currently researching updating the method of evaluating occupant protection. The following process is a work-in-progress, not completely validated and approved, but represents the new direction NASA is researching for occupant protection design and validation. Occupant protection, as described here, include methods and best practices that can be applied to protect crewmembers from injury due to transient loads, whether they are translational or rotational.

Reliable injury predictive tools and injury criteria are required to ensure that human-rated spacecraft are designed with the appropriate level of occupant protection. It is important that both the occupants be protected from injury and that the vehicle is designed without excessive protections that lead to unnecessary vehicle weight and complexity. Approaches to ensure safety, such as those used in the commercial aviation and automotive industry, provide a foundation for human-rated space flight for new vehicles; however, their application requires modification and study.

Brinkley Dynamic Response model looks at the accelerations due to external forces, such as landing loads, acting upon a lumped mass representing the human body. A more detailed analysis needs to be completed in conjunction with the Brinkley Dynamic Response model to see how these forces and acceleration changes affect the specific parts of the human body. For example, the torso may be restrained with a harness to the seat, but the limbs may be unrestrained. Here, the forces of contact between the limbs and the vehicle need to be reduced to ensure minimal injury to the crew.

Proper support and restraint of the body components can reduce the risk of injury and needs to be addressed by both the vehicle and the flight suit system (if included). Many parameters affect the likelihood of injury during dynamic flight events, including extrinsic factors such as g-loading, velocity change, rate of acceleration onset, acceleration rise time, bone and soft tissue compression, tension, extension, flexion, shear force magnitudes and directions, deflections of the body components, etc., as well as intrinsic factors of the crew such as age, gender, physical condition, deconditioning due to spaceflight, and degree of muscle tension. Reliable injury predictive tools and injury criteria are required to ensure that human-rated spacecraft are designed with the appropriate level of occupant protection.

Designing a spacecraft to carry humans into low Earth orbit (LEO) or beyond and returning them safely to Earth presents unique challenges due to the varying environments the spacecraft must withstand during the ascent, descent, and landing phases of flight. Unlike the highly standardized methods of verifying occupant safety in other industries, such as commercial aerospace and automotive, safety of a spacecraft must be determined as a function of the craft design and expected environments. During all phases of flight, the crew will be exposed to accelerations of varying intensity, duration, and orientation. Therefore, simple adoption of standardized methodologies of injury assessment from other industries (such as commercial aircraft) is not possible for any spacecraft.

6.5.4.3.2.1 Brinkley Limitations

There are several reasons why NASA is moving away from using only the Brinkley Dynamic Response model, to using an additional method for assessing occupant protection. The Brinkley Dynamic Response (BDR) model is a simple, lumped-parameter, single-degree-of-freedom model that estimates the whole body response due to applied acceleration. Although the model gives ranges of injury risk, only the DR_{+z} (originally named the Dynamic Response Index or DRI) has been correlated to injury risk and only for thoracolumbar injuries during ejections.

For the other axes, the risk of injury is approximate, and β values should not be correlated to a particular injury risk. In addition, the model is based on several assumptions that must be met for the model to be valid.

The seat used in the development of the model was a simple, generic seat with side supports and no gaps between the subject and the seat. The restraints used were the equivalent of a modern 5-point racing harness. Brinkley (1985) expected that different dynamic models would be necessary to make assessments for a different seat and restraint configuration. Because the model treats the whole body as a lumped mass, the seat geometry and restraints used on the test data are critical to achieve the same results. The implications of these limitations are two-fold: either inaccurate injury risk predictions, which can result in unneeded vehicle mass; or, worse, crewmember injury. Since the model does not account for improvements in restraint systems, which have been significant over the last 25 years, or improvements in seat design, a design based on the BDR may be either overly conservative or not as protective as possible. If the model does not adequately reflect the true injury risk, injuries can occur even though designers may believe the design to be safe. This was shown operationally in Royal Air Force ejection injury rates that were not predicted by the DRI (Anton, 1986; Lewis, 2006). Also, if the alignment of the spine and load vector is greater than 5° , the risk of injury increases dramatically. This was determined operationally on the F-4 ejection seat, where the spine was misaligned by approximately 12° and resulted in a 34% rate of injury. Only a 5% risk of injury was predicted by the BDR model (Brinkley & Schaffer, 1971; Mohr et al., 1969). Finally, because the model was developed for seated subjects with minimal or no gaps between body regions and restraints, the model carries the assumption that the design prevents gaps in the spacecraft seat and restraint design. Gaps allowed beyond those employed in the original dataset could increase contact forces and the risk of injury.

An additional concern for spaceflight is the pressure suit. Since the BDR model was developed without a pressure suit, care must be taken to assure that the basic assumptions of the BDR are upheld. First, the original BDR model was developed with minimal head supported mass (helmets that weighed less than 5 pounds). Increased head supported mass poses a real risk to the neck due to compressive loading during +Z accelerations, which are not accounted for in the BDR model (Radford et al., 2011). Second, additional helmet and distributed suit mass (which is likely given NASA's current designs) may cause the natural frequency and damping parameters of the human to change, invalidating the model. Third, recent post-mortem human subject (PMHS) studies conducted by NASA at Ohio State University (OSU) investigated the effect of rigid suit elements during landing impacts (Dub & McFarland, 2010). Although a small number of PMHSs were tested, the results clearly indicated that the rate of injury from poorly placed suit elements drastically increased the risk of injury and showed that the BDR model did not predict injuries during the tests, as expected.

The BDR is based on human volunteer testing of military test subjects who were primarily young, fit males (25 ± 5 years old, 178 ± 6 cm height, and 75 ± 10 kg in weight; Stapp & Taylor, 1964). Since gender and age affect impact tolerance, this model may not adequately address injury risk for populations outside of this range. As of September 2011, the astronaut population is 46 ± 4 years old, 175 ± 6 cm in height, and 75 ± 10 kg, and is 24% female and 76% male. Recent research has shown that women may be at a greater risk of injury, and 5th percentile females may

be at greatest risk when using the BDR model, as it does not adequately predict this increased risk (Buhrman, et al., 2000).

Finally, the BDR model was developed based on simple acceleration profiles, which may not represent the complex loads expected for current capsules and other future spacecraft.

6.5.4.3.2.2 Injury Assessment Reference Values

In addition to the Brinkley Dynamic Response Model, recent advances in the automotive industry have provided additional tools for assessing injury risk during impact and dynamic loads. It is helpful to review other industries and their respective risk postures to gain insight into what NASA's injury risk posture should be.

For the automotive industry, specifically passenger cars, most injury limits are based on a 5% to 50% risk of an Abbreviated Injury Scale (AIS) 3+ injury, which is a severe injury (Association for the Advancement of Automotive Medicine, 2005). Although this seems like an objectionable risk posture, there are two main reasons why this posture is acceptable. One, these limits are based on standardized tests that represent a worst case, and not a representative collision. Two, the probability of being injured any time a person gets into a vehicle is very remote for passenger vehicles (1 in 120,000) (National Center for Statistics and Analysis 2009; Bureau of Transportation Statistics, 2007). Therefore, the total risk of injury is very low.

The situation is similar for military aircraft, although more risk is involved. Military aircraft are designed to allow a higher risk posture than what is desired for NASA. Again, these higher levels of risk have been deemed appropriate, since the risk of injury per sortie is 1 in 670 or better, even though this is significantly higher than in passenger cars (Mapes, 2006; Somers, et al., 2010).

For NASA, the situation is very different. With passenger vehicles, millions of miles are driven each year with a relatively low risk of collision or injury. For the most part, the risk is constant during the entire trip or "sortie." Similarly, for military aircraft, thousands of flight hours are logged with relatively low risks of injury. Like military vehicles, there is significant risk during the entire mission (enemy fire, mechanical failures, pilot errors, etc.), with a higher risk of injury during takeoff and landing. For NASA, risk of crew injury due to transient accelerations is concentrated during launch and landing. These flight phases produce the highest loads on the vehicle. Unlike passenger vehicles and military aircraft, there is very low risk of injury due to impact once a stable orbit has been reached, since very small loads are applied to the vehicle. The launch, abort, and landing environments for NASA are extreme compared with what is nominally experienced during driving or flying. Because of this, it is appropriate to compare these environments to automotive collisions and military aircraft off-nominal operations (ejections, emergency landings, etc). Since a NASA vehicle will be exposed to these environments every flight, the risk posture must be very conservative to achieve a low total injury risk. Table 6.5-11 shows the risk posture NASA may adopt for these cases.

Table 6.5-11 Definition of Acceptable Risk

<i>Injury Description</i>	<i>Injury Class</i>	<i>Overall Probability of Injury</i>
Minor	I	5%
Moderate	II	1%
Severe	III	0.03% [0.3%]*
Life-Threatening	IV	0.03%

* Acceptance of values in brackets assumes Search and Rescue (SAR) forces can access the crewmembers within 30 minutes of the mishap occurrence.

To assess injury risk, several methods may be used. Because injury risk cannot be measured directly, other methods must be used to estimate risk. Figure 6.5-10 shows many of the available methods.



Figure 6.5-10 Methods of estimating and assessing human injury risk.

Table 6.5-12 Comparison of Human Injury Risk Methods

Method	Pros	Cons
Animal Testing	<ul style="list-style-type: none"> • Can test injury injurious accelerations • Can sacrifice animal post-test to determine injury pathology 	<ul style="list-style-type: none"> • Not a direct measure of human responses • Animals may not have the same responses to impact

Cadaveric Testing	<ul style="list-style-type: none"> • Can test injury injurious accelerations • Can perform autopsy post-test to determine injury pathology • Can test male and female subjects, as well as a range of anthropometries 	<ul style="list-style-type: none"> • Not representative of a live human (muscle tension, etc.) • Significant variability between subjects • May not represent crew population in age, skeletal strength, etc.
Human Exposure Data	<ul style="list-style-type: none"> • Contains human non-injury and injury data • May include high quality acceleration measurements for some datasets with an on-board event data recorder 	<ul style="list-style-type: none"> • May not be representative of spacecraft environment • Not well controlled impacts (unknown subject position, restraint usage or tension) • Significant variability between subjects
Human Volunteer Data	<ul style="list-style-type: none"> • Can test exact spacecraft system, orientation, and equipment • Can get qualitative data on discomfort • Can directly validate designs with sufficient sequential human trials • Can test male and female subjects, a range of anthropometries, and possibly age 	<ul style="list-style-type: none"> • Cannot test beyond human tolerance limits • Need large N to verify low injury risk levels • Higher variability • Cannot test exact acceleration profiles (only approximations in laboratory environments)
Physical Anthropomorphic Test Devices (ATD)	<ul style="list-style-type: none"> • Repeatable (little variability between tests) • May be biofidelic in some cases • Allows for testing at injurious levels • Responses can be related to injury risk 	<ul style="list-style-type: none"> • Not human, so may not respond exactly like a human • Cannot measure or report injury risk outside of specific instrumentation • Limited anthropometry options
ATD Numerical Models	<ul style="list-style-type: none"> • Same advantages as the physical ATD • Can also be used in simulations of complex acceleration environments • Allow measurement of additional parameters to aid in understanding landing behavior 	<ul style="list-style-type: none"> • Same drawbacks as the physical ATD • May not respond the same as the Physical ATD • Sensitive to initial conditions
Human Numerical	<ul style="list-style-type: none"> • Models are anatomically accurate 	<ul style="list-style-type: none"> • Limited anthropometric sizes

Models	and include soft tissue, bones, and organs	<ul style="list-style-type: none"> Limited validation (no validation in the +G_x and +G_z)
Mathematical Models	<ul style="list-style-type: none"> Simple to implement 	<ul style="list-style-type: none"> Do not account for interactions between body regions or complex interactions with the seat Do not account for changes in seat design

Based on these options, the Trauma device for Human Occupant Restraint (THOR) Modification Kit Anthropomorphic Test Device (ATD) is being pursued by NASA for predicting injury risk. The THOR ATD is the newest generation of crash test dummy developed by the National Highway Traffic Safety Administration (NHTSA), and will allow crewmembers' risk of injury to be evaluated and determined if it meets the levels shown in Table 6.5-11 with respect to the injury severity. The values will be assessed with the THOR Modification Kit Anthropomorphic Test Device (ATD) in accordance with SAE J211/1 and J1733 standards (Society of Automotive Engineers 2007a, 2007b).

To evaluate risk of injury using an ATD, metrics measured on the manikin are used to assess injury risk. The following injury metrics were identified for protecting the crew:

- Head Injury Criteria (HIC), 15 ms
- Rotational Brain Injury Criteria (BRIC)
- Peak Upper Neck Axial Tension Force
- Peak Upper Neck Axial Compression Force
- Maximum Chest Compression Displacement
- Peak Ankle Dorsiflexion Moment
- Peak Ankle Inversion/Eversion Moment
- Contact Force

In addition, a deconditioning factor is needed for cases where the crew has been exposed to reduced gravity. Nominal landing limits are set for loads, deflections, etc. to keep significant injury risk low, with additional tolerance reductions resultant from the crew being deconditioned due to long-duration space flight. Therefore, a scaling factor is needed for non-launch abort landing scenarios in the form of a deconditioning coefficient that adjusts for the reduced capacity of the crewmember to endure flight/landing loads. It is assumed that the crew in launch abort landing scenarios will not be deconditioned.

The deconditioning factor can be multiplied by the able-bodied loading limits to account for vertebral strength loss that occurs in space. For purposes of this analysis, the deconditioning factor was assumed to be a proportionality factor relating the allowable pre-flight skeletal loading to the allowable post-flight skeletal loading after deconditioned BMD loss. The deconditioning factor was calculated from changes in BMD occurring over a typical long-

duration mission (~6 months); however, due to the limited range of mission durations for the data, this deconditioning factor is more appropriate for missions no greater than 6 months. The following deconditioning factors have been derived as noted:

ϕ - deconditioned crew coefficient for femur and tibia = 0.75

ξ - deconditioned crew coefficient for spinal elements and head = 0.86

To set injury limits for each injury metric, Human Volunteer Testing will be conducted to assure any limits obtained through ATD testing are safe.

6.5.4.3.2.2.1 Head Injury Criteria

To calculate Head Injury Criteria (HIC) 15, the following equation is used (National Highway Traffic Safety Administration, 1995):

$$HIC_{15} = \max_{0 \leq t_2 - t_1 \leq 0.015} \left((t_2 - t_1) \left[\int_{t_1}^{t_2} a(t) dt \frac{1}{t_2 - t_1} \right]^{2.5} \right)$$

where $a(t)$ is the resultant head acceleration measured at the head center of gravity (CG) within the THOR head form. Note that the HIC is calculated for all window sizes from 0 to 15 milliseconds for each time point.

6.5.4.3.2.2.2 Rotational Brain Injury Criteria

To calculate BRIC, the following equation is used (Takhounts, et al., 2011).

$$BRIC = \frac{\omega_{max}}{63.5} + \frac{\alpha_{max}}{19,500}$$

where α_{max} is the maximum resultant head rotational acceleration in radians/second², and ω_{max} is the maximum resultant head rotational velocity in radians/second. Both are measured at the head CG within the THOR head form.

6.5.4.3.2.2.3 Neck Axial Tension

Neck axial tension forces are measured from the upper neck load cell (the z-axis force). Measurements, polarity, and filtering are to be conducted per SAE J211/1.

6.5.4.3.2.2.4 Neck Axial Compression

Neck axial compression forces are measured from the upper neck load cell (the z-axis force). Measurements, polarity, and filtering are to be conducted per SAE J211/1.

6.5.4.3.2.2.5 Maximum Chest Compression

For chest compression, the maximum value of the four chest deflection sensors is taken. Measurements, polarity, and filtering are to be conducted per SAE J211/1.

6.5.4.3.2.2.6 Ankle Moments

For ankle rotations, the maximum moments recorded from each ankle are to be used. Measurements, polarity, and filtering are to be conducted per SAE J211/1.

6.5.4.3.2.2.7 Contact Force

The contact force limits apply to the extremities (arms, hands, legs, and feet) as well as the head. If an extremity or head is not in contact with a surface at the initiation of the impact, or if it was in contact but moves away from that surface during the impact, any contact thereafter is applicable to this limit. For example, if the head is resting on the back liner of the helmet and bounces off during the impact, the secondary contact would be compared. However, if no break in contact occurs, verification by inspection may be used to assure that the contact limits are met.

6.5.4.3.2.3 Injury Assessment Reference Values

Injury risk functions are used to develop Injury Assessment Reference Values (IARVs) associated with the injury probabilities (in Table 6.5-11). The injury risk functions are created with the risk levels and the criteria values based on ATD testing and human volunteer testing. The IARVs are currently under development, but a sample value table appears below (Table 6.5-13). Once established, the IARVs must not be exceeded for each dynamic phase of flight.

Table 6.5-13 Table of Sample THOR IARVs

	<i>Conditioned</i>	<i>Deconditioned</i>
HIC 15	100	100
BRIC	0.48	0.48
Neck Axial Tension Force [N]	870	750
Neck Axial Compression Force [N]	830	710
Max Chest Deflection [mm]	30	30
Ankle Dorsiflexion Moment [Nm]	18	14
Ankle Inversion Moment [Nm]	17	13
Ankle Eversion Moment [Nm]	17	13
Contact Force [N]	170	130

6.5.4.3.2.4 Determination of Assessment Cases

Due to the complexity and cost of manufacturing a new spacecraft, much of the design work for assessing structural integrity and crew safety during landing may be based with analytical methods. As a result of the inherent uncertainty of environmental factors affecting impact conditions, landing assessments are often performed with a probabilistic approach, including

consideration of worst case scenarios. This section provides a high level overview of the process that may be used to establish landing conditions due to environmental factors and the subsequent down-selection process to a subset of cases for detailed crew injury assessment.

To accurately predict landing probabilities, parameters that affect landing orientation and velocity are to be included in landing probability analysis. Some of the parameters that factor into the analysis include reentry attitude, parachute performance, hang angle, wind speed, and sea state (e.g., wave height, frequency, angle, shape, direction, etc.) or terrain (e.g., slope, soil conditions, etc). Because some of the parameters are correlated (i.e., horizontal wind speed and sea state), a probabilistic approach may be preferable to reduce the number of possible conditions for landing. The output of this analysis would describe the initial conditions of the vehicle orientation and dynamics in relation to the water or land surface. These parameters should include normal velocity, relative angle of impact, roll, pitch, and yaw angles, horizontal and vertical velocities. This process will need to be conducted for all nominal and for select off-nominal landing environments. The off-nominal landing environments may include parachute out conditions, off-target landing locations, pad- and ascent-abort landing conditions, etc.

Once a distribution of landing parameters is generated, a systematic method for selecting critical landing cases for further analysis is necessary. There are many methods for determining the selected cases. Two methods will be discussed here. For either method, success criteria will be developed based on the probability of occurrence and acceptance of risk under each condition.

6.5.4.3.2.4.1 The Boundary Selection method

The Boundary Selection method defines a boundary along the distribution that splits the acceptable and unacceptable landing cases. The assumption is that all cases on one side of the boundary are acceptable and meet all the crew injury requirements, and the cases on the other side do not meet all the requirements. Additional analysis should be conducted to show that the boundary satisfactorily meets this assumption. Once this boundary is defined satisfactorily, cases near the boundary on each side are selected for further analysis. The method for selecting the cases should be justified and the number of cases should be justified statistically.

6.5.4.3.2.4.2 Response Surface modeling

Response Surface modeling is an alternate approach to selecting cases to analyze, and may be used separately or to define the boundary in the previous method. In this method, a statistically significant number of cases are selected uniformly from the entire distribution. These cases are modeled as described below in the following sections. The results of these analyses are used to estimate the injury response of all of the landing cases using a response surface. See NASA/TM-2009-215704 for additional information on the method (Horta, et al., 2009). Once these analyses are conducted, additional critical landing cases can be selected near areas where cases may be approaching the threshold of failing the requirements.

6.5.4.3.2.4.2.1 External Dynamics Simulation

Once critical landing cases are selected, landing simulations of the entire vehicle are conducted. This simulation provides the necessary loads and dynamics information needed to drive the crew interface subsystem model. This model may have increasing levels of fidelity based on the design phase, allowing for more detailed results in each subsequent design phase.

6.5.4.3.2.4.2.2 Occupant Modeling

When the time histories of the vehicle dynamics from landing are estimated, the next step is to model the crew-interface (i.e., crew positions). As before, this is an evolutionary process where low-fidelity models may be used early in the design process and are then replaced by higher-fidelity models as the design matures. Using these models, crew responses will be simulated by using information from the loads and dynamics obtained from the critical landing cases.

Initial low-fidelity models should allow evaluation of the Brinkley criteria at a minimum. To accomplish this, the model must account for energy attenuation to accurately predict the accelerations at each crew location.

For the medium-fidelity model, modeling of the crew interface is needed, including the seat and any energy attenuation systems. This fidelity model also requires a human surrogate model to be restrained in the seat. Models of the suit, if applicable, should be included, even if they are of a low-fidelity nature. The Anthropomorphic Testing Device (ATD) may be of a lower fidelity than those used in the final high-fidelity model.

Similar to the medium-fidelity model, a high-fidelity model should include all aspects of the crew interface and should include all the details of the flight configuration. In addition, the ATD should be a high quality model providing accurate crew injury metrics.

6.5.4.3.2.4.3 Physical Testing

Because the above analysis is highly dependent on responses of Finite Element (FE) models, physical testing is required to support the validity of the analysis. The simulations must be validated with physical test data to correlate the model responses with the real performance of the system.

6.5.4.3.3 Occupant Protection Considerations

6.5.4.3.3.1 Deconditioning

During spaceflight, physiological changes occur in response to microgravity (see HIDH Chapter 5). Concerning impact tolerance, the two main physiologic changes are to bone and surrounding muscular tissue. Although decrements in bone mineral density and muscle mass have been shown, it is unclear what the consequences of these losses are on impact tolerance, particularly for the spine. Additional research is needed to address this gap in knowledge.

6.5.4.3.3.2 Gender and Anthropometry

Unlike previous NASA capsule designs, future NASA vehicles must be capable of accommodating men and women in a wide range of anthropometrics. Current NASA vehicle requirements stipulate a vehicle must accommodate a 1st-percentile female to a 99th-percentile male. Protecting for such a wide range of sizes is a challenge, as most occupant protection data are based either on young, male, military subjects or on elderly, male, postmortem human subjects (PMHS). Because of this, determining risk for the entire astronaut corps is a challenge.

6.5.4.3.3.3 Pressure Suit

One of the unique aspects of the NASA spaceflight environment is the pressure or space suit. This suit protects the crew from the vacuum of space by providing a pressure environment around the body, a breathable atmosphere, thermal protection, as well as micrometeorite protection (when outside the vehicle). There are several considerations for the occupant during abort and landings that relate to suit design. Pressure suits worn by crewmembers have the potential to adversely affect crew injury risk. This may be attributed to several aspects: the helmet design, pressure suit fit (including when inflated), and rigid elements of the suit.

Helmet:

- In situations where a +Z axis (eyeballs down) acceleration acts on the crewmember, head supported mass may become a concern, as it will increase the axial loading and bending moments on the cervical spine.
- In addition, improperly designed helmets have the possibility of injuring the crew through secondary impacts between the head and helmet. The Columbia Crew Survival Investigation Report recommends designing suit helmets with head protection as a functional requirement, not just as a portion of the pressure garment. Suits should incorporate conformal helmets with and neck restraint devices, similar to the helmet/head restraint techniques used in professional automobile racing (National Aeronautics and Space Administration, 2008)
- Impact protection should meet or exceed the specifications set out in the Federal Motor Vehicle Safety Standard 218: Motorcycle Helmets (National Highway Traffic Safety Administration, 2012).

Pressure Suit:

- The suit may create gaps between the occupant and the restraints and/or seat. The restraints may effectively restrain the suit, but the crewmember may still move within the suit, potentially causing injury when the crewmember impacts the inside of the suit.
- Even if the suit is not inflated to a contingency pressure (i.e., in the event of a cabin depressurization), the designer must consider the residual pressure of the Environmental Control and Life Support System as it could produce sufficient pressure (even under 1 psi) to prevent a crewmember from tightening the restraints adequately.

Rigid Elements:

- Testing conducted on rigid elements has shown that severe injuries may be caused even during accelerations that would otherwise not cause injury (Brinkley $\beta_{Low} < 1.0$) (Dub & McFarland, 2010). Practical considerations for rigid elements are:
 - Prevent rigid elements from causing point loading on the body, particularly between the restraint, seat system, and the body. Examples would be a waist ring that contacts the seat and causes loading on a localized region of the spine during

impact or shoulder bearings beneath the shoulder restraints causing little restraint of the upper torso and point loading during accelerations as the torso engages the bearings.

Prevent masses from impacting the body during dynamic events. Rigid or massive elements attached to the suit have potential for causing injuries. An example would be an umbilical connected and mounted on the chest and supported by flexible material. During dynamic loads, this mass could move rapidly into the body causing injury.

6.5.4.4 Countermeasures for Transient Translational Acceleration

Since all U.S. spacecraft to date have had unpowered flight during entry and landing, reducing both horizontal and vertical velocity to decrease landing impact has been an important design consideration. The Space Shuttle landed on a runway as a glider, and impact loads were minimal. However, with other designs such as capsules or lifting bodies, this type of landing may not be possible. Because they have a lower coefficient of lift, these types of spacecraft use other methods for slowing the spacecraft sufficiently to minimize impact forces. With the exception of the Soyuz 1 parachute failure in 1967, impact forces on return from space flights to date have generally been well within human tolerance limits (Table 6.5-7). Adaptation to 0g or partial gravity should be considered when reducing the effect of transient loads on the crew, since adaptation will reduce tolerance. Landing on land or water will also affect impact forces. The following is a summary of design considerations for minimizing injury from transient translational accelerations.

- **Restraint system:** The ability of the human to withstand deceleration also has to do with the design of the crew restraint system. In the absence of proper restraint, whiplash and submarining injuries of the spinal column may occur. Stapp (1951) successfully demonstrated that, using a restraint system with shoulder, multiple torso, lap, helmet and submarining straps, he was able to endure +x (chest) acceleration levels up to 45.4g, with a rise time of 0.11 seconds and a velocity change of approximately 56 m/s. However, such a restraint system may affect operations, since it may be complex to don and may restrict the occupant's mobility. In addition, modern race cars have shown that five-, six-, and seven-point racing harness with the Head and Neck Support (HANS[®]) Device have dramatically reduced injuries even when drivers are exposed to extremely high loads (Somers, et al., 2011).
- **Couches:** Human tolerance to impact improves when the contact area between the body and restraint system is greater (National Aeronautics and Space Administration, 2007). A concept for providing body support and protection is a rigid, individually contoured couch, like those used in the early U.S. space program and in the current Russian Soyuz capsule. This approach ensures that each external body segment will be simultaneously decelerated on landing and that the support pressure gradients exerted on the body surfaces will be minimized. Some previous designs have been uncomfortable because only one body position matched the contour, which also made different types of movement difficult. Considerations for adequate spacecraft control should be made when designing the couch.

- **Crushable structure:** It is important to consider that the spacecraft itself could provide reduction of impact forces, with the use of structural design and materials that can absorb energy upon being crushed.
- **Stroking seats:** The Apollo Command Module included a crew couch/frame that was supported in the crew module by struts and had built-in Y-Y struts to stroke, to attenuate landing loads for water landings and potential hard landing during aborts. However, this added design complexity and created unpredictable secondary dynamics.
- **Retrorockets:** The Russian Soyuz uses retrorockets in addition to contoured couches. After entry, the heat shield is discarded, exposing six retrorockets, four of which are automatically fired at about 1 m (~3 ft) above the ground. The other two rockets may be activated in the event of an off-nominal entry. The retrorockets help dampen landing loads imparted to the crew.
- **Airbags:** Before splashdown, the Mercury capsules had the heat shield drop to extend a landing bag, or an impact skirt, under the spacecraft to help dampen landing loads imparted to the crew (Figure 6.5-11).

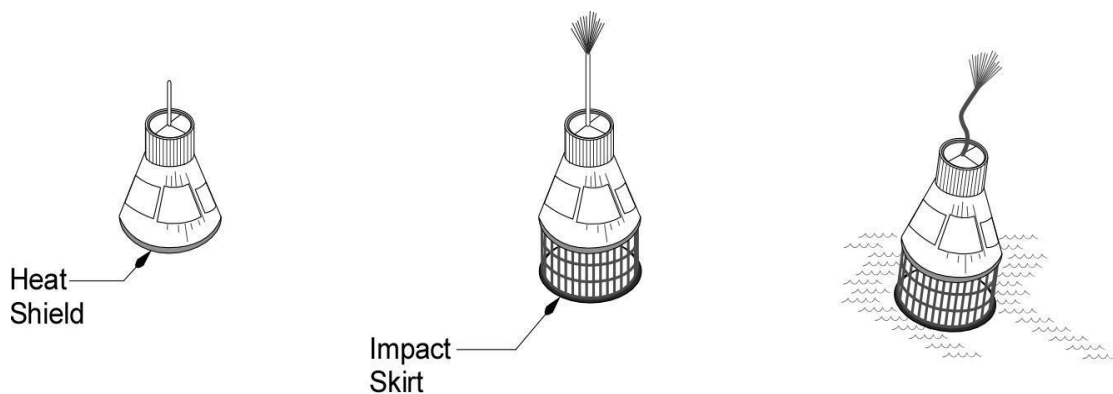


Figure 6.5-11 Mercury capsule landing bag (impact skirt).

6.5.5 Research Needs

- Understanding the effect of partial-gravity (Moon, Mars) adaptation on human acceleration tolerance (sustained, transient, and rotational acceleration)
- Understanding the interaction of 0g with acceleration and vibration
- Current restraint and impact attenuation technology
- Understanding the effects of spaceflight deconditioning to impact tolerance
- Understanding the effects of the pressure suit on impact injury risk
- Understanding impact injury risk during low severity impacts

6.6 ACOUSTICS

Acoustics is the science and technology of sound, including its production, transmission, and effects. Sound is generally used to refer to any vibration or pressure fluctuation, in the air or any other physical medium, that is sufficient to stimulate an auditory sensation. The primary concern here is with sound that arrives at the crewmember's ear, which can be classified either as desired *signals* or undesired *noise*. This section sets forth the basis for spacecraft requirements to allow audibility of the signals, and to control the noise. (For discussions regarding auditory perception, see section 5.5.)

This section discusses

- Acoustic environments of spacecraft
- Human response to noise
- Human exposure and habitability limits
- Noise control in spacecraft
- Verification of acoustic requirements
- Acoustic monitoring of spacecraft
- Acoustic countermeasures

Definitions for terms used in this section are in paragraph 6.6.8 at the end of the section.

6.6.1 The Acoustic Environments of Spacecraft

The acoustic environments of spacecraft are greatest in magnitude during dynamic phases of flight, such as launch, entry, and on-orbit engine burns. For these short-duration events, high levels of acoustic loading are generated by the nature of flight and the propulsion required. These inherently high levels of noise should be considered and controlled. To this end, acoustic requirements during these mission phases need to be developed and enforced to protect the crew's hearing, must allow for critical communications, and may require hearing-protective equipment to help achieve these results.

In contrast to the extreme acoustic environments described above, the sound levels present during the vast majority of time spent during space flight missions is characterized by lower-level noise generated by the spacecraft and all added equipment, such as experiments and government furnished equipment (GFE), inside the reverberant habitable spacecraft volume. In these habitable environments, the crew's ability to communicate easily and concentrate on tasks is the main focus of the requirements. If these objectives are controlled, then there will be no threat to the crew's hearing. To these ends, the spacecraft acoustic requirements need to provide a reduced-stress environment to promote the crew's communications, productivity, and well-being. Also, the need for personal hearing protection should be minimized as these devices interfere with communications, are uncomfortable to wear for long periods, and, in some cases, promote infections. To achieve these results, the noise produced by the spacecraft needs to be controlled during design, development, and fabrication by using acoustical design and noise-control practices such as early testing of components, use of acoustic modeling, and use of an acoustic noise-control plan. Finally, satisfaction of acoustic requirements must be verified either by test, or by analysis based on supporting test data.

6.6.1.1 Launch

During launch, a great amount of noise is caused by the combustion process in the rocket engines, engine jet-plume mixing, unsteady aerodynamic boundary-layer pressures, and fluctuating shockwaves. Although these sources are very powerful and create very high levels of acoustic sound pressure, they are present for a relatively short amount of time. This short-term noise exposure normally does not exceed 5 minutes of continuous duration. The main focus of controlling noise during this phase of flight is on protection of crew hearing and preservation of critical communications capability. At launch, crews are nominally wearing spacesuits including helmets, which provide noise attenuation and hearing protection. Communications headsets are worn inside the suit to provide additional hearing protection and support communications in the noisy environment.

The noise environment within the spacecraft is, initially, the result of high-level jet noise of the booster rockets impinging on the outer surface of the fuselage and being transmitted through the cabin structure into the spacecraft interior. As the spacecraft accelerates from the launch pad, noise reduces due to loss of ground reflection, and jet noise diminishes as velocity increases. With increasing velocity, however, the crew compartment receives aerodynamic noise generated by boundary-layer turbulence and shock structures along the outer surface of the fuselage. This aerodynamic noise reaches its maximum level as the spacecraft passes through the range of maximum dynamic pressure (max Q) and decreases progressively thereafter. Aerodynamic noise becomes insignificant approximately 2 minutes after liftoff. The noise levels inside the crew compartment will vary with the size and shape of the launch vehicle, its engines, and the design of the heat shield, pressure vessel, and crew compartment. As an example, Figure 6.6-1 shows Space Shuttle orbiter maximum noise, both external and internal to the crew module, during the atmospheric launch phase. Figure 6.6-2 shows the profile of the A-weighted sound levels over the launch period. Crewmember noise exposure levels are less than the internal noise level because of the attenuation offered by the suits and helmets (NASA-STD-3000, 1995).

The aeroacoustic noise sources may also generate significant levels of infrasonic and ultrasonic acoustic energy. These sources must also be considered. The noise levels generated at launch also create a risk to the spacecraft's payload and to the spacecraft itself because of possible sonic fatigue and related vibration issues. Discussion of these effects are out of the scope of this chapter except to acknowledge these concerns as serious and to assert that control of the noise for protecting the human crew also helps to reduce the risk to the spacecraft and its payload.

The noise created by the launch-abort system must also be considered and may be the most powerful of all. In this case, the rocket engine is located in close proximity to the crew, and the acceleration required to separate the crew module away from the rest of the already-moving spacecraft demands extreme levels of thrust and power, and will result in very high noise levels.

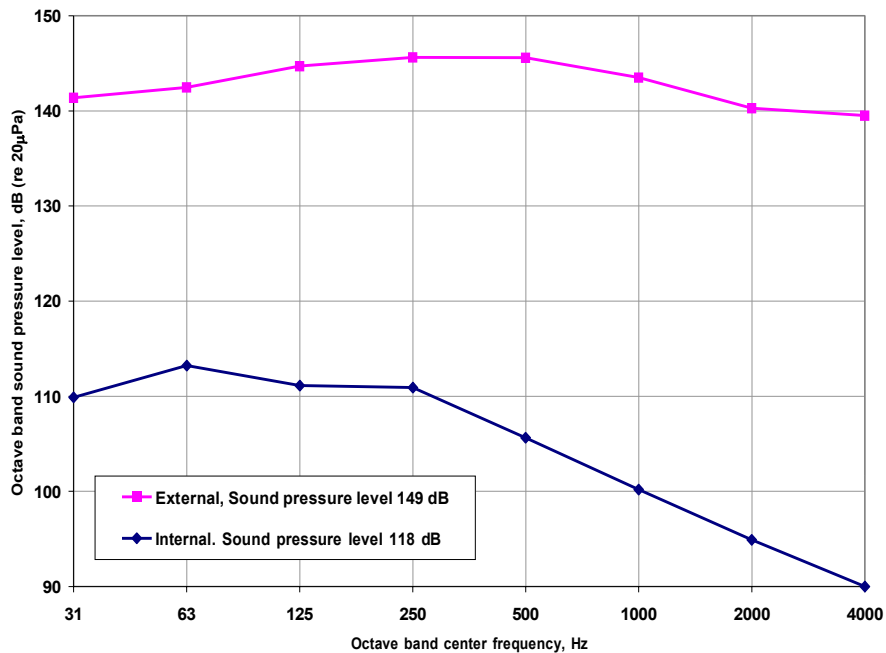


Figure 6.6-1 Measured Space Shuttle orbiter crew module maximum noise during launch phase (NASA-STD-3000, 1995).

STS-3 Launch Noise (Flight Deck)

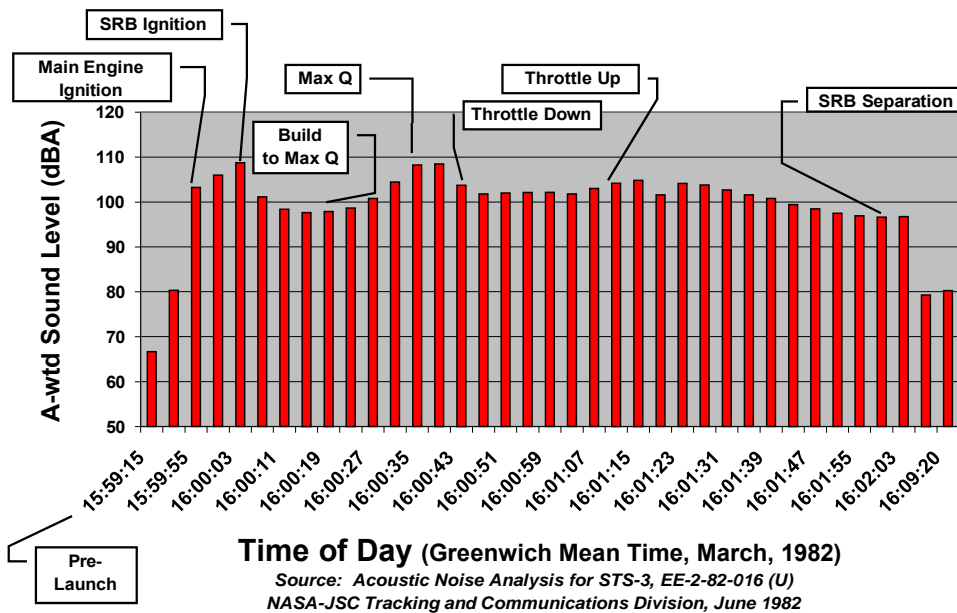


Figure 6.6-2 Space Shuttle orbiter internal noise. Noise in the flight deck during the atmospheric launch phase as a function of time, analyzed using a 4-second time window (Nealis, 1982).

6.6.1.2 Atmospheric Entry

During atmospheric entry, aerodynamically generated noise is caused by turbulent boundary layers, attached shockwaves, and attached supersonic expansion-fans on the external surface of the spacecraft. The noise environment is dominated by this aerodynamic noise containing broadband noise of high intensity. The sound pressure levels during entry may be comparable with those produced during the maximum dynamic pressure at launch, but the high intensities may be maintained for a longer period during entry.

As with the launch aerodynamic noise, the entry-related aeroacoustic noise sources may also generate significant levels of infrasonic and ultrasonic acoustic energy.

6.6.1.3 On-Orbit Engine Burns

In addition to launch and entry noise, noise is also associated with engine “burn” or “boost” operations, including attitude control maneuvers, and the translunar-injection burn that boosts a spacecraft from a LEO toward the Moon. Although noise during typical burn and boost operations is generally at a much lower level than launch and entry noise, the crew may not be suited, and will have reduced hearing protection capability. The possibility exists that associated vibrations may be structure-borne into the crew cabin and radiated as noise. The noise levels associated with engine burns are not well understood because they have never been measured, but on the basis of crew debriefings in previous programs, they were thought not to be of concern because of their short duration and the accommodations provided for launch noise attenuation. Some anecdotal accounts tell how the crew could feel the vibration of the engines or about the acoustic levels, but no data exist at this time.

6.6.1.4 On-Orbit, Lunar, or Planetary Acoustic Environment

During on-orbit, lunar, or extraterrestrial planetary operations when engines are inactive, the emphasis regarding the acoustic environment is not to protect crew hearing, but rather to ensure adequate communications, alarm audibility, crew productivity, and habitability. Therefore, the maximum allowable sound levels are lower than those required for launch and entry. Hearing conservation concerns will be satisfied as a consequence of meeting these lower noise level requirements. These environments are “shirt-sleeve” environments, and the crew will not be wearing hearing protection during nominal operations.

For example, sound levels in the Spacelab Module, a research module located in the Shuttle’s cargo bay during STS-40, were measured to be 68 dBA, on a daily average basis, but rose on some days to be as high as 75.5 dBA and up to 84 dBA during ergometer operations (Goodman, 1991b). As a result, serious problems with communications, both with the ground and between crewmembers, were experienced. Communications capability within the Spacelab had become obscured by the high ambient noise levels of the experiment hardware, and the crew had to move into the airlock (away from the experiments they were operating) to communicate. Communications in the Spacelab needed to be repeated; “say again” was the phrase repeated over and over again, and the crew became very frustrated (Goodman, 1991a). Noise levels in the Orbiter Crew Module during STS-40 also were high, reaching daily averages as high as 71 to 73 dBA compared to 73.5 to 75.5 dBA in Spacelab. The crew was very irritated during operations

and sleep periods, and had headaches due to the high noise levels experienced (Goodman, 1991a). This is an example of a mission of short duration (less than 30 days) in which high noise levels became a problem because of the resulting poor communications and habitability.

For long-duration missions, high noise levels have been documented on the Russian space station *Mir* and within the ISS (Goodman, 2003; Allen & Denham, 2011; Bogatova, 2008). Many instances of crew permanent and temporary hearing loss have been documented, especially in the *Mir* program (Clark and Allen, 2008). Regarding the ISS, the acoustic noise environment during early Increment missions was identified by the Astronaut Office and Space Life Sciences Directorate as one of the top habitability concerns, and a key area for improvement. Related concerns include the inability to communicate with the ground and each other, and the inability to hear emergency and warning alarms. As a result of the high noise levels in certain modules, the ISS crew has worn hearing protection throughout the workday and often while sleeping. Comments that have been compiled from ISS crew debriefings include the following:

- *The noise level on board was considered to be unpleasant and too high for general comfort.*
- *The noise levels on the ISS have been known to affect a given crew's ability to communicate.*
- *The crew has had difficulty communicating with each other while wearing hearing protection.*
- *Overall, the crewmembers would wear their ear protection all day and take it out at night. Some crewmembers, depending on where they were sleeping and the associated noise level, would leave their ear plugs in while sleeping.*
- *It is not practical to require the crewmembers to wear hearing protection round the clock – need to design for less noise in the future.*
- *There have been several instances where the crew has been awakened due to noise levels on board.*
- *Many of the crewmembers have recommended that we continue to try and reduce the noise levels on station.*
- *When we build new modules, go to the Moon, and go to Mars, things need to be kept quieter. We need to take into consideration the cumulative effect of all noise-producing parts and not just each hardware item in isolation.*
- *The noise mitigation products that we use are not solutions; we need to find a way to better design things to produce minimal noise-level output.*

Controlling the acoustic environment in spacecraft is a challenge. Because of the difficulty in controlling the noise environment, well-defined acoustic requirements and processes for controlling noise during the selection of prime movers (such as fans and pumps) and during the design phase of the spacecraft are crucial. A noise-control plan must be established within system development efforts. The program would include the following elements:

1. **Select Quiet Sources** – Many systems create noise during nominal operations. These systems include mechanical components, such as pumps, fans, compressors, and motors, which could be running at all times or just intermittently. Selection of quiet noise sources is very important to reducing noise levels, and should minimize propagation path treatments.
2. **Design for Noise Control** – Measures to absorb or block noise along the path from source to receiver can be included to control noise during the design of the hardware. By including these noise controls as part of the design process, designers can avoid later impacts to the design. For example, inclusion of mufflers upstream and downstream from a ventilation fan that supplies the crew cabin will reduce the amount of duct-borne noise coming from that fan into the crew cabin through both the cabin intake grill and the outlet diffusers. Covering fan casings with absorption and barrier material can significantly reduce fan case radiated noise.
3. **Suballocate Requirements** – Allocation of requirements to systems and subsystems is very important so that components can be evaluated independently and controlled to assure that overall system limits are not exceeded. Also, acoustic modeling techniques now allow acoustical predictions of complicated and unique geometries and are proving to be very useful tools in the design and integration of hardware.
4. **Conduct Acoustic Testing** – Early and frequent periodic testing of components and systems is one of the most effective means of identifying noise problems.

See section 6.6.4 below for more details.

6.6.1.5 Extravehicular Activity Acoustic Environment

EVA is always a critical mission activity with significant risk to crew safety and to the success of the overall mission as a result. It is extremely important that voice communications be clear, speech intelligibility high, and warning signals from EVA life support systems heard.

During EVA mission phases, crewmembers are exposed to the noise environment created by the spacesuit's life support system. For the most part, the noise comes from fans, pumps, and airflow. When the spacesuit is connected to the spacecraft, noise can come through the umbilical connection or through the visor if it is open.

The extremely small and highly reverberant acoustic cavity inside the helmet causes the noise levels to build up and causes standing wave patterns to exist. The crewmembers wear communications headsets for clear communications; however, noise levels can be high enough to interfere. Also, high noise levels can be picked up by the suit microphone and obscure the voice of the crewmember so that ground personnel cannot understand their speech. See section 11.3.11 for further information on EVA-related noise issues.

Development of acoustic requirements for each mission phase, including launch, entry, on-orbit, and EVA phases, is described below. However, before this discussion, it is important to present some further information about the human response to noise.

6.6.2 Human Response to Noise

6.6.2.1 Noise exposure is generally considered to affect hearing, but it can also cause other physiological effects. Noise may also create irritation, cause headaches, and degrade sleep and relaxation as well as performance of specific activities (e.g., working and speech communications). Even noise that the crew does not perceive as harmful may cause deleterious effects, as crews may become desensitized to elevated noise levels or not consider the noise to be objectionable (i.e., broad-band, ultrasonic, or infrasonic noise). For example, humans can just perceive a 3dB change in noise, but this is the equivalent of doubling or halving of acoustic power. Because of this insensitivity to sound pressure level changes, it is important to rely on quantitative noise measurements when designing hardware and verifying acoustic characteristics of space vehicles. Physiological Effects

Reserved

6.6.2.2 Performance Effects

6.6.2.2.1 Interference with Speech Communications

Crewmember efficiency is impaired when noise interferes with voice communication. When this occurs, the penalty is an increase in time required to accomplish communication through slower, more deliberate verbal exchanges (if possible). Missed or misunderstood speech can have significant safety impact resulting from human error.

The frequencies used for voice communication range from about 200 to 7000 Hz, with primary energy in the region of 500 Hz to 2 kHz. Table 6.6-1 indicates various levels of speech based on vocal effort (Berger, 2003). Continuously raised, loud, or shouted speech occurs in noisy environments because talkers raise their voice to a level where they can hear themselves (a phenomenon known as the “Lombard Effect”). A raised voice may also result in sore throat or hoarseness.

Table 6.6-1 Speech Levels for Male and Female Voices at a 1-Meter Distance

Vocal Effort	Male dBA	Female dBA
low	52	50
normal	58	55
raised	65	62
loud	76	71
shout	89	82

Average A-weighted sound levels (Berger, 2003).

6.6.2.2.1.1 Signal-to-Noise Ratio

The concept of *signal-to-noise ratio* (expressed in decibels) is fundamental to understanding general statements regarding speech intelligibility.

Normal speech has a level of 58 dBA at a distance of 1 meter from a talker to a listener. If the background noise is 52 dBA at the head position of a listener, for example, then a positive signal-to-noise ratio of 6 dB is said to exist.

Generally speaking, at least a 10-dB signal-to-noise ratio in the frequency region of speech (200 Hz–7 kHz) is optimal for making speech intelligible (approximately 90% word recognition).

6.6.2.2.1.2 Intelligibility Tests

Speech may be *detectable* at lower levels, but not intelligible. In other words, a listener might recognize speech is occurring at lower signal-to-noise ratios than 10 dB, but not understand it. Intelligibility testing is a more precise measurement of word recognition. Intelligibility testing can be done either with or without test subjects. Standardized speech intelligibility tests that use test subjects are listed below. ANSI S3.2-1989 standardizes and describes the tests.

- The Modified Rhyme Test in ANSI standard S.3.2-1989 is one of the preferred methods since human test subjects are used. It is a test with 300 monosyllabic English words. Listeners are shown a six-word list and then asked to identify which of the six is spoken by the talker. The words differ in either the initial or final consonant sound.
- The Diagnostic Rhyme Test is a test of 192 monosyllabic words that also uses human subjects. Listeners are shown a word pair, and then asked to identify which word is presented by the talker.
- The Phonetically Balanced Monosyllabic Intelligibility test is a word test that is used when the highest accuracy and sensitivity are required.

The disadvantage of using human-in-the-loop testing is that it can be time-consuming and costly, particularly when doing an iterative design process.

ANSI S.3.5-1997 is a human-independent system that involves measurements of signal-noise ratios in bands, as opposed to measuring speech intelligibility. Although humans are not used in this test, it has a good track record in terms of predicting how humans would score on tests such as the Modified Rhyme Test or Diagnostic Rhyme Test. It can also be adjusted for a person wearing high-attenuation hearing protection devices, and for presence of visual cues.

6.6.2.2.1.3 Speech Interference Levels

Speech intelligibility tests are typically used to define, characterize, and validate speech communication systems. For designing and assessing acoustic environments regarding the crew's ability to communicate, speech interference levels are also used.

Masking of speech occurs at low signal-noise ratios; i.e., when the presence of one sound, such as noise, inhibits the perception of speech. The Speech Interference Level (SIL) is defined as the arithmetic average of noise in octave bands either 500 Hz, 1 kHz, 2 kHz, and 4 kHz (four-band method) or 500 Hz, 1 kHz, and 2 kHz (three-band method).

The SIL can then be used in conjunction with graphs such as Figure 6.6-3 to determine the impact of talker-to-listener distance and the level of voice power required to communicate. The region in Figure 6.6-3 each curve shows the talker-to-listener and noise-level combination for which just-reliable face-to-face communication is possible.

Just-reliable communications corresponds to an intelligibility score of at least 70% based on ANSI S3.2-1989 (ANSI S12.65-2006). Previous spaceflight standards require 75% intelligibility (MSIS, 1995)

The parameter on each curve in Figure 6.6-3 indicates the relative voice level. The expected voice level indicates the tendency for people to raise their speaking level in the presence of background noise. If the speaker is female, the level of voice output shown in Figure 6.6-3 should be reduced by 4-5 dB (Crocker 1998, Beranek 1992).

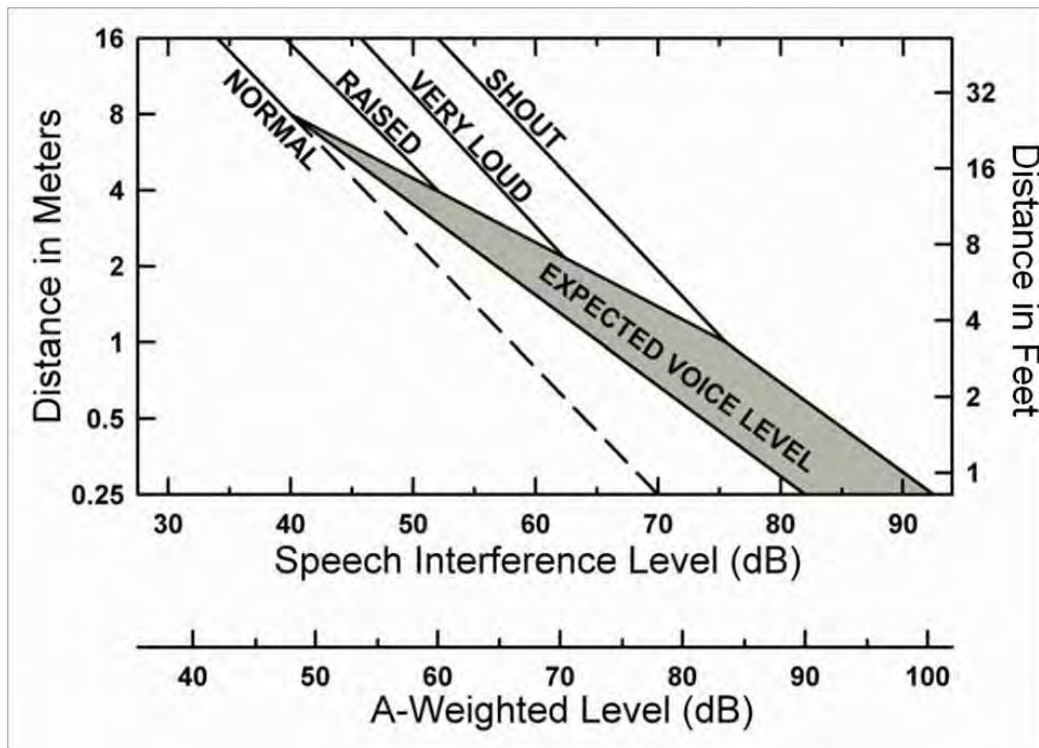


Figure 6.6-3 Talker-to-listener distances for just-reliable communication. The A-weighted sound level shown below the abscissa is approximate. The relation between speech interference level and A-weighted sound level depends on the spectrum of the noise (ANSI S12.65-2006).

Table 6.6-2 indicates the impact of different SIL values on person-to-person communications in tabular form (NASA-STD-3000, 1995).

Table 6.6-2 Speech Interference Level (SIL) and Effect on Communication

SIL (dB)	Person-to-Person Communication
30– 40	Communication in normal voice satisfactory.
40–50	Communication satisfactory in normal voice 1 to 2 m (3 to 6 ft), and raised voice 2 to 4 m (6 to 12 ft), telephone use satisfactory to slightly difficult.
50– 60	Communication satisfactory in normal voice 30 to 60 cm (1 to 2 ft), raised voice 1 to 2 m (3 to 6 ft), telephone use slightly difficult.
60– 70	Communication with raised voice satisfactory 30 to 60 cm (1 to 2 ft), slightly difficult 1 to 2 m (3 to 6 ft), telephone use difficult. Ear plugs and/or ear muffs can be worn with no adverse effects on communication.
70– 80	Communication slightly difficult with raised voice 30 to 60 cm (1 to 2 ft), slightly difficult with shouting 1 to 2 m (3 to 6 ft). Telephone use very difficult. Ear plugs and/or ear muffs can be worn with no adverse effects on communication.
80– 85	Communication slightly difficult with shouting 30 to 60 cm (1 to 2 ft). Telephone use unsatisfactory. Ear plugs and/or ear muffs can be worn with no adverse effects on communication.

Factors other than noise levels can influence the intelligibility of speech and should be considered when developing requirements for spacecraft:

- Visual cues (lip reading) can increase intelligibility in noise. However, in 0g environments the possibility of differing orientations can negate this effect.
- Reverberation, significant reflections, and echoes can affect voice communications positively or negatively. These effects can be important in spacecraft, which are typically small in volume with high levels of reverberation. Communications can also be impaired when speakers and listeners have different native languages, dialects, or accents.

6.6.2.2.2 Interference with Task Performance

Noise can have both positive and negative effects on the performance of tasks; noise stimulates the listener, but arousal results in the narrowing of attention (Butler, TBD). As the noise intensity increases, increased arousal causes an improvement in task performance up to a point; beyond that level of intensity, over-arousal sufficient to degrade task performance occurs. Accompanying the degraded task performance, psychological effects of noise can include anxiety and learned helplessness.

In some cases, noise may communicate important informational content (e.g., feedback regarding the operation of a mechanical device, such as a fan).

It is important to take into consideration factors such as the person's level of familiarity with the work, the degree to which verbal communication is necessary, the extent to which several parts of a task make conflicting demands on attention, and duration of the noise or the task (Jones, 1991).

Continuous noise as high as 100 dBC does not affect simple tasks, visual acuity, tool use, or short-term intellectual function. This is particularly true when discriminations are easy, time pressure is absent, or the response manner or time is predictable. Below are specific task performance areas that noise does affect:

- a. Short-Term Memory – If several operations are connected that require short-term memory, for instance to solve a mathematical problem that appears only briefly, noise can have an impact.
- b. Comparison and Discrimination – At levels as low as 85 dBC, there may be an effect on confidence in the nature of unexpected visual signals that are difficult to discriminate, or on tasks that require remembering and comparing signals.
- c. Multitasking – Continuous noise also has an adverse effect on cognitive performance that may involve “multitasking.” If the same material can be analyzed in more than one way, the most dominant and obvious means will be adopted during continuous noise. Given two memory tasks under relatively high (75-100 dBC) continuous background noise levels, noise can even improve efficiency at the dominant task, but with a corresponding degradation in a secondary task.
- d. Spatial Memory – Tasks involving the learning of lists, e.g., from a repair manual, may involve verbal or spatial memory tasks; noise hinders those who use a spatial strategy.
- e. Visual Tracking – Continuous regular periodic and aperiodic noise reduces performance on a complex visual tracking task. At levels of 50, 70, and 90 dB of white noise, the greatest decrement occurred with the highest noise level.

Short-term changes in level that are infrequent can cause temporary disturbance of performance of 2 to 30 seconds, with a loss of efficiency proportional to the change in level. This can affect changes in reaction time, ability to focus on visual tasks or take information from visual displays, and other cognitive activities. Irregular and unpredictable bursts of noise outside of the control of the subject are more disturbing to performance than those that are *perceived* to be within the subject's control, even when the subject does not control them.

6.6.2.3 Annoyance Effects

Elevated noise levels above background noise or exposure to constant levels of moderate noise can delay the onset of sleep, awaken one from sleep, and interfere with rest and with the hearing of wanted sounds. In past space flight missions, comments have been made by crewmembers about irritating and disturbing noises.

Awakenings are the most relevant noise annoyance problem in spacecraft because of the potential for intermittent and impulse noise events such as pumps turning on. To some degree, these events could be masked by the relatively high background noise levels.

Habituation to noise events during sleeping can occur; research indicates that during the same night, awakening decreases with an increasing number of sound exposures per night, and that the frequency of noise awakenings decreases for at least the first eight consecutive nights. However, perceived sleep quality, mood, and performance can be affected despite habituation (Öhrström, 1988). Sleep does not mitigate any negative effects of noise on physiology (e.g., increased blood pressure).

Tonal or narrow-band noise can be irritating and distracting. In addition, tonal noise that fluctuates in level or produces a beating phenomenon (when combined with another tone with similar frequency) will draw attention and be particularly distracting.

6.6.3 Human Exposure and Acoustic Environment Limits

The guidelines of this section will ensure that spacecraft provide the crew with an acoustic environment that will not cause injury or hearing loss, interfere with voice communications, cause fatigue, or in any other way degrade overall human-machine system effectiveness. Requirements should be developed with regard to the particular mission or activity being performed. Overall layout of the spacecraft should include acoustical considerations to provide appropriate noise environments for the situation, including such factors as mission purpose, duration, crew size and mix, size of habitable volume, external support, and distance between crewmembers.

6.6.3.1 Noise Exposure Limit for Intrinsic High Noise Level or Off-Nominal and Contingency Conditions

Equivalent noise exposure levels above 85 dBA for an 8-hour time-weighted average have been shown to increase the risk of noise-induced hearing loss (NIOSH, 1998). The recommendation of NIOSH is that noise exposure level at the crewmember's ear, calculated over any 24-hour period, must be limited to 85 dBA, 8-hour time-weighted average, using a 3-dB energy exchange rate. The formulae below can be used to calculate 24-hour noise exposure levels, D. To be acceptable, D must be at or below 100.

$$D = 100 \sum_{n=1}^N \frac{C_n}{T_n},$$

N is the number of noise exposure events during the 24-hour period, C_n is the actual duration of the exposure event in minutes, and T_n is the maximum noise exposure duration allowed, based on the specific sound level, L_n , of an exposure event in dBA, calculated using

$$T_n = \frac{480}{2^{(L_n - 85)/3}}$$

Noise level dosimeters are capable of measuring noise levels and making these calculations.

Appropriately chosen hearing protection or communication headsets may be used to satisfy this requirement.

Noise dose limits must be used to define the design requirement for mission phases, such as launch and entry, in which the sources of noise are at intrinsically high levels and the protection of crew hearing is the primary concern. For on-orbit and planetary operations where communications, productivity, and habitability are primary concerns, noise dose considerations should not determine requirements. The resulting allowable limits would be too high for these activities and do not address spectral concerns.

Note that the noise exposure limits are expressed in A-weighted sound pressure levels to include effects throughout the entire audible frequency range, but with weighting that represents the frequency response of the human ear to high noise levels. (For a more detailed explanation of noise weighting, see Beranek, 1992.) Contributors to noise exposure include continuous and intermittent noise sources. Impulse noise is too short in duration to contribute significantly to the noise dose, though current noise dosimeters are capable of including impulse noise peaks in the measurement. Separate limits are needed to limit the traumatic effects of high levels of impulse noise. See section 6.6.3.9 for more details.

6.6.3.2 Hazardous Noise Level Limit for Intrinsic High Noise Level or Off-Nominal and Contingency Conditions

Control of noise exposure using the above noise dose limits is effective in reducing the risk of noise-induced hearing loss. However, because of the asymptotic nature of the expressions given for T_n in 6.6.3.1, limits must be set to define a maximum exposure level for short-duration exposures to protect the crew. As with the noise dose limit in 6.6.3.1, this guideline must be used to define a design requirement for mission phases, such as launch and entry, in which the sources of noise are intrinsically at a high level and the protection of crew hearing is the primary concern.

If communications and alarm audibility are not important (e.g., during launch abort just after the abort rocket has fired), the noise level at crew ear locations must be limited to a maximum of 115 dBA for any duration, to prevent damage to crew hearing (NIOSH, 1990). This is the hazardous noise level limit.

For the crew to hear voice communications and alarms during launch, abort, entry, and pressure relief valve operations, this hazardous noise level limit must allow headroom for amplified communication signals and alarms to be effective but not damage crew hearing. As given in section 6.6.3.3, “Noise Limit for Personal Communication Devices,” the noise limit at the crewmember’s ear from communication devices is limited to 115 dBA. To preserve a 10-dB signal-to-noise ratio for this signal, a maximum limit of 105 dBA on the noise environment at crew ear locations must be imposed.

6.6.3.3 Noise Limit for Personal Communication Devices

Sound levels produced by personal communication devices are allowed to be high to overcome the noise generated during launch and descent. However, noise levels above 115 dBA have been shown to produce noise-induced hearing loss (NIOSH, 1990). The A-weighted sound levels at crew ear locations from personal communication devices must be limited to a maximum of 115 dBA to prevent damage to crew hearing.

In addition, personal communication devices must be provided with a volume adjustment to allow manual reduction of the noise levels when high levels are not needed.

A personal communication device may be an integrated part of the EVA helmet or an independent communication headset.

6.6.3.4 Sound Pressure Level Limits for Continuous Noise During Nominal Operations

To permit voice communications and promote habitability during nominal on-orbit, lunar, or extraterrestrial planetary operations, noise levels must not exceed specified limits. In addition, limits with lower levels are needed for sleep quarters to allow auditory rest and recovery.

Sound pressure level requirements for continuous noise are based on the “noise criterion” family of curves developed by Beranek for the acoustical design of office buildings. These NC curves are shown in Figure 6.6-4 (Beranek, 1992), and are defined using octave band sound pressure levels as a function of frequency over a range from 63 Hz to 8 kHz. The NC designator of each curve, e.g. NC-40, was originally defined to correspond to the (rounded) SIL value (see 6.6.2.2.1) of each curve. However, new standard octave bands were developed subsequent to the development of the NC curves, changing slightly the frequency range on which the NC curves were based (Crocker, 1998). As a result, not all of the NC designators match the corresponding SIL values exactly, but they are close in value. The A-weighted sound levels of the NC curves differ from the NC designations and SIL values by 7 to 12 dB. These corresponding values are also shown in Figure 6.6-4 for reference, but are not considered to be part of the definition of the NC curves. Correspondence between NC curves and A-weighted sound levels only apply to the NC curves themselves, and not to other spectra that happen to meet a particular NC criterion. The NC rating of a spectrum is designated as the value of the highest NC curve “touched” by the measured octave-band spectrum (ANSI/ASA S12.2-2008).

In the habitable volume, where good voice communications are required, sound pressure levels of continuous noise should be limited to the values given by the NC-50 curve. This limit was originally recommended for the Space Shuttle Program (Goodman, J., Noise Control Standard RID, 1973) and was later adopted and confirmed as the requirement for the International Space Station (ISS Design Control Board, 25 August, 1997; Fotedar, 2001). Figure 6.6-5 shows that, for speaker-to-listener distances from 5 to 8 feet, an NC-50 background noise level provides for greater than 75% of key words in sentences to be correctly understood whereas NC-55 results in only 30% of key words understood (Pearson, 1975).

For noise limits in areas where speech intelligibility is not important, or for areas where the crew are not going to spend much time, e.g. in storage areas, designers usually feel pressure to consider more relaxed acoustic requirements. This approach is used on marine ships (ABS, 2003). However, for spacecraft it is recommended that consistent requirements be used throughout the system because available habitable volumes are often used for unintended purposes, and because the designed use of a habitable volume may evolve over time. For example, on the ISS, visiting Space Shuttle crews sometimes use docking compartments or unused habitable areas as sleep quarters.

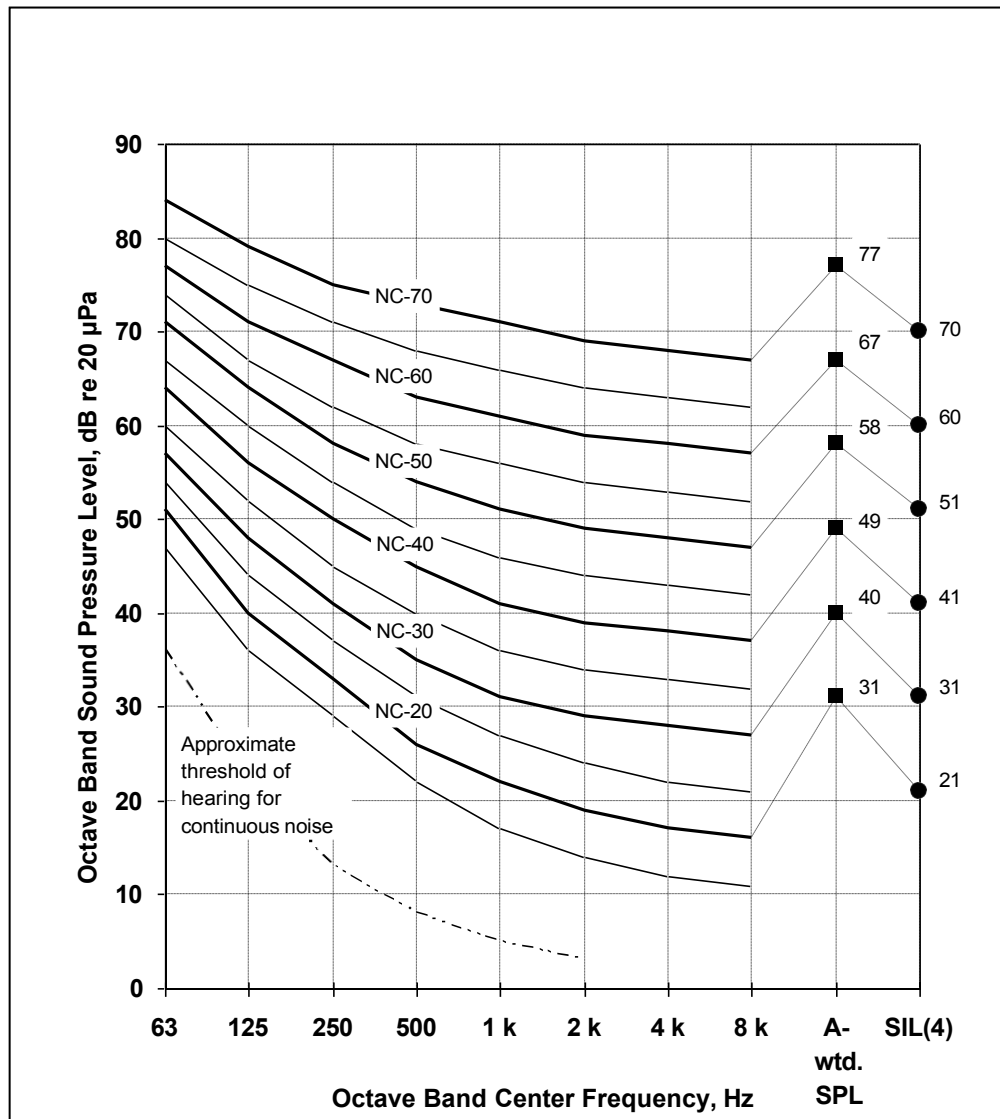


Figure 6.6-4 Noise criterion (NC) curves. Corresponding A-weighted sound pressure levels and speech interference levels are given for reference only (Beranek, 1992; ANSI/ASA S12.2-2008). SIL(4) is speech interference level, 4-band method.

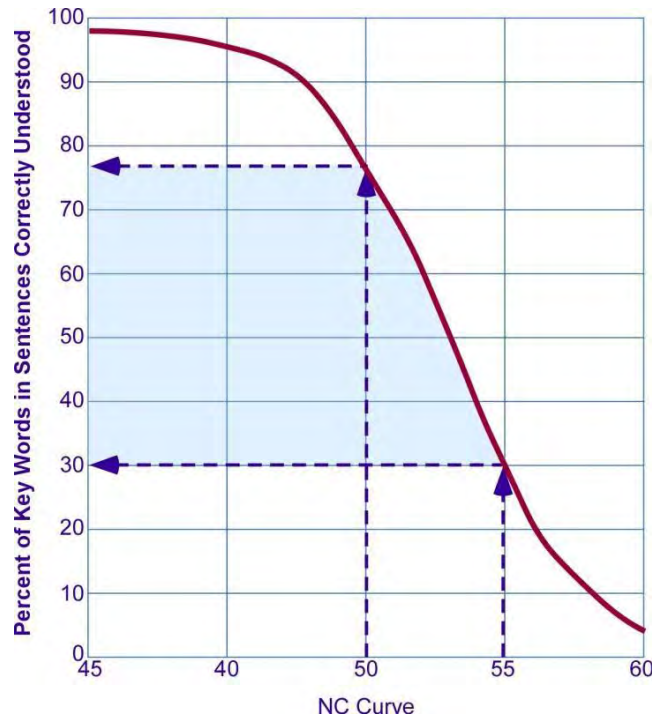


Figure 6.6-5 Percent of key words in sentences correctly understood. Key words in sentences correctly understood as a function of the NC curve for male talkers with normal voices at a face-to-face distance of 5 to 8 feet on board the Space Shuttle (Pearson, 1975).

For crew quarters and sleep areas, sound pressure levels of continuous noise should be limited to the values given by the NC-40 curve as a maximum. In addition, a minimum noise limit of NC-25 is also recommended. These limits provide a comfortable sleeping and resting environment (Beranek, 1992) and allow rest for the crew's ears. Intermittent noise, impulse levels, or tones in these areas must not exceed 10 dB above the basic background levels that exist in these areas to avoid sleep disturbances.

It should be clear that the continuous noise limits for work and sleep areas must include the composite levels of all continuous noise sources that contribute to the acoustic environment inside the spacecraft. Systems and subsystems must be given an allocation of the total work or sleep noise limits, such that the combination of all allocations will still be within the limits. The noise limit values corresponding to the NC-50, NC-40, and NC-25 curves for work areas, sleep areas maximum, and sleep areas minimum, respectively, are given in Table 6.6-3. Levels for the octave band just above the given frequency range have been added to extend the frequency coverage of the NC curves (Goodman, 2008) as shown in Table 6.6-3. These limits were extended to limit the effects of sources that produce a very high-frequency, high-level noise that is in the audible frequency range.

Table 6.6-3 Octave Band Sound Pressure Level Limits for Continuous Noise, dB re 20 μ Pa

Octave band center frequency (Hz)	63	125	250	500	1 k	2 k	4 k	8 k	16 k	NC
Work areas	71	64	58	54	51	49	48	47	46	50
Sleep areas maximum	64	56	50	45	41	39	38	37	36	40
Sleep areas minimum	54	44	37	31	27	24	22	21	20	25

6.6.3.5 Sound Pressure Level Limits for Intermittent Noise During Nominal Operations

For intermittent noise of specific hardware items that are inherently noisy and operate for short time periods, e. g. toilets, where alternative means for noise control are prohibitively expensive or impractical, A-weighted sound level limits given by Table 6.6-4 are recommended. These sound levels and operational duration limits (per 24-hour period) are based on ISS experience (SSP 57000, 2000), with some precedence from the Space Shuttle Program.

Use of these requirements should be limited and based on a clear understanding that multiple intermittent sources must not combine to preclude communications when needed or create an unsafe situation. Allowing use of these requirements for a specific hardware item must be considered on a case-by-case basis. For example, a vacuum cleaner that must be operated by a crewmember and is typically noisy is a good candidate for this requirement. Alarm audibility during operation of equipment that uses this requirement must also be considered. Intermittent noises should be minimized during crew sleep periods.

Table 6.6-4 Intermittent Noise A-Weighted Sound Pressure Level and Corresponding Operational Duration Limits for Any 24-Hour Period

Maximum Noise Duration Per 24-hour Period	A-Weighted Sound Level (dBA re 20 μPa)*
8 hours	≤ 49
7 hours	≤ 50
6 hours	≤ 51
5 hours	≤ 52
4.5 hours	≤ 53
4 hours	≤ 54
3.5 hours	≤ 55
3 hours	≤ 57
2.5 hours	≤ 58
2 hours	≤ 60
1.5 hours	≤ 62
1 hour	≤ 65

30 minutes	≤ 69
15 minutes	≤ 72
5 minutes	≤ 76
2 minutes	≤ 78
1 minute	≤ 79
Not allowed **	≥ 80

*Measured at 0.6 m distance from the source.

**To leave margin from the 85 dBA hazardous noise limit.

6.6.3.6 Hazardous Noise Levels During Nominal Operations

For nominal on-orbit, lunar, or extraterrestrial planetary operations, an A-weighted sound pressure level of 85 dBA is the hazardous noise limit at which action must be taken to reduce the noise level so that increased risk for hearing loss does not occur.

A sound level of 85 dBA is also recommended for use as the limit for broadcast alarms and for maintenance operation head locations where closeout panels are removed for access.

6.6.3.7 Tonal and Narrow-Band Noise Limits

To prevent irritating and distracting noise, the maximum sound pressure level of narrow-band noise components and tones should be limited to at least 10 dB less than the broadband sound pressure level of the octave band that contains the component or tone. This requirement originated from Manned Space Center (MSC) 8080 specifications, and does not apply to alarms or desired acoustic signals.

A sound level of 85 dBA is recommended for use as the limiting level for broadcast alarms (see section 10.9 for additional discussion of auditory alarms).

6.6.3.8 Reverberation Time

Reverberation of sound within a volume can degrade speech intelligibility. Limiting the reverberation time, through the shape of and materials used in a spacecraft, can reduce this negative effect. A maximum reverberation time of 0.5 seconds (with a tolerance of +0.1s, -0.3s) must be provided in the 1 kHz octave band and is recommended in the 500 Hz and 2 kHz octave bands. Reverberation should be measured using the specific natural frequency of the room when verifying that octave band. These reverberation limits will prevent degradation of speech intelligibility by no more than 10% for ideal signal-to-noise ratios greater than 30 dB, or 15% for a signal-to-noise ratio of 3 dB (Harris, 1998). These reverberation time limits apply to rooms of approximately 100 cubic meters. For other room volumes, the reverberation time of spacecraft compartments must be adjusted according to the criterion given in Figure 6.6-6 for conversational speech (NASA-STD-3000, 1995).

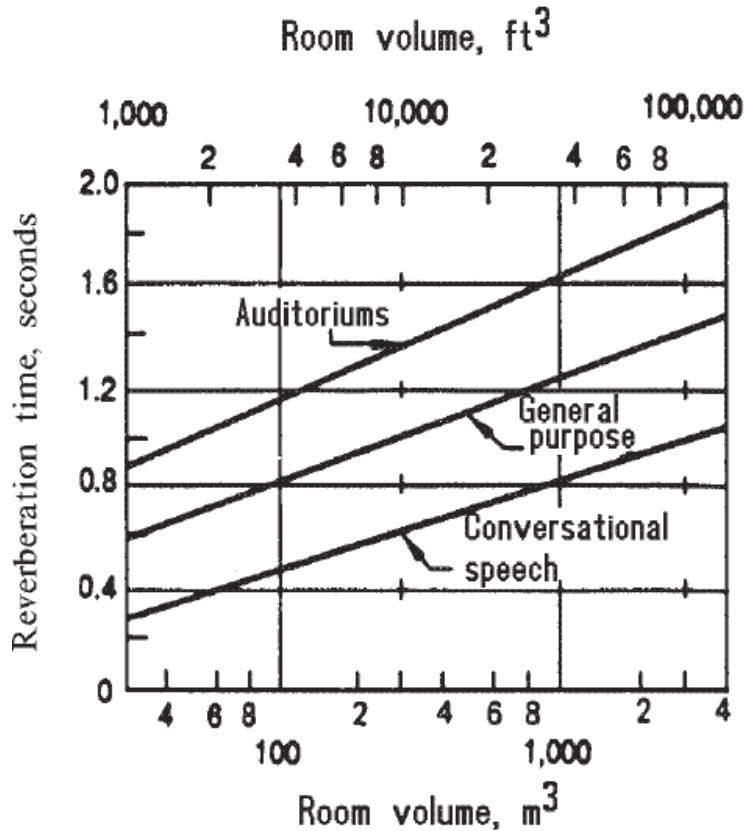


Figure 6.6-6 Reverberation time as a function of room volume (Farrell, 1975).

6.6.3.9 Impulse Noise Limits

Space flight hardware must limit impulse noise measured at the crewmember's ears to less than 140 dB peak sound pressure level. This limit will prevent trauma to the hearing organs caused by impulse noise (MIL-STD-1474D, 1997). This impulse noise limit is needed to prevent acoustic trauma caused by single or multiple impulses. It covers both A- and B-duration waveform patterns associated with short- and long-wavelength bursts. (MIL-STD-1474, 1997) for a discussion of impulse noise duration and measurement techniques).

More stringent impulse noise requirements may be warranted depending on crew activity or mission-imposed exposures. During crew sleep, a lower level or complete absence of impulse noise is needed to avoid waking the crew. Impulse noise must be limited to a level of not more than 10 dB above the composite background noise.

To prevent the crew from being startled, unexpected impulse noise at the crewmember's ears should be limited to less than 120 dB peak sound pressure level (Kryter, 1994). Lower-level unexpected impulse noise below 120 dB may also cause the crew to be startled and should be avoided, if possible.

Note that the peak sound pressure level used to control impulse noise is not weighted, so that low-frequency acoustic energy is not reduced in strength.

6.6.3.10 Infrasonic Noise Limits

Infrasonic sound pressure levels, including frequencies from 1 to 20 Hz, should be limited to less than 150 dB at the crewmember's head location. This limit will prevent nausea, lightheadedness, and other effects associated with high levels of infrasonic noise (American Conference of Governmental Industrial Hygienists, 2001). It should be noted that hearing protection is not effective in attenuating noise in this low-frequency range and should not be used in the satisfaction of this requirement.

6.6.3.11 Ultrasonic Noise Limits

Ultrasonic noise should be limited to the values given in Table 6.6-5 (ACGIH, 2004).

Table 6.6-5 Ultrasonic Noise Limits Given in One-Third Octave Band SPLs

One-third Octave Band Center Frequency (kHz)	Limits (one-third octave band SPL (dB))	
	Not to Exceed	8-hr TWA
10	105	89
12.5	105	89
16	105	92
20	105	94
25	110	-
31.5	115	-
40	115	-
50	115	-
63	115	-
80	115	-
100	115	-

6.6.3.12 Loudspeaker Alarm Audibility

Loudspeakers used for alarms must produce nonspeech auditory annunciations that exceed the masked threshold by at least 13 dB in one or more one-third octave bands where the alarm resides, as measured at the crewmember's expected work and sleep station head locations. The 13-dB signal-to-noise ratio ensures that nonspeech auditory annunciations are sufficiently salient and intelligible (ISO, 2003a).

Alarm audibility is an important safety-related acoustical requirement. Sound levels from audio alarms need to be considered when looking at maximum exposure limits. These levels are inherently tied to the acoustic requirements, in particular to the continuous noise limit that determines the composite spacecraft noise environment.

This alarm audibility limit is included in the audio displays section, but is also included here since verification of the requirement requires acoustic testing and coordination with the continuous noise limits.

6.6.4 Noise Control of Spacecraft

Limiting the acoustic exposure levels during on-orbit, lunar, or extraterrestrial planetary operations in the crew compartment and habitat is deemed essential to achieve a safe, functional, effective, and comfortable acoustic environment for the crew. A noise control plan is necessary to define and lay out the plans and efforts required to achieve compliance with the acoustic requirements. The status and progress of the noise control plan needs to be actively monitored to ensure good communications on efforts to limit noise, to identify any areas of emphasis and concerns early in the design process, and to allow timely remedial actions to be taken (Goodman & Grosveld, 2008). Significant portions of the text, figures, and tables of this section came from Goodman and Grosveld (2008).

6.6.4.1 Noise Control Plan

A noise control plan, at a minimum, should include:

- The overall noise control strategy
- The supporting acoustic analysis approach
- The testing and verification procedures for the system and hardware components

6.6.4.1.1 Noise Control Strategy

A sound source radiates energy that is perceived at the receiver location as a pressure deviation from the local ambient pressure. The source is characterized by the sound energy per unit time, or sound power, and the pressure deviations at the receiver are measured as sound pressure levels. The sound energy emitted from the source follows various paths into the compartment. The acceptability of the resultant acoustic levels at the crew receiver location is defined by the requirements for the habitable environment. Unwanted sound is defined as noise. Noise control is the application of designs and technology necessary to limit the noise at the source, along its path, and at the receiver location to acceptable levels (Goodman & Grosveld, 2008).

6.6.4.1.2 Noise Sources

It is important to identify and control the sources of noise, for they provide acoustic energy to the crew compartment or habitat of a spacecraft. Noise sources need to be classified as to whether they are continuous or intermittent because environmental limits in space operations are specified in this manner. Fans, pumps, motors, and compressors are usually the dominant continuous noise sources. There are two basic alternatives to noise source control:

- Select or develop noise sources that are quiet by design while considering acoustic emission, as well as other characteristics in the choice of this hardware.
- Focus on development activities to quiet the selected design or hardware to the extent required.

Sound sources should be characterized by their sound power output level. This information is provided by either the designer or the supplier, and measured in accordance to applicable international standards (ISO, 2003b).

6.6.4.1.3 Noise Paths

Three basic sound paths need to be addressed:

- Airborne
- Structure borne
- Enclosure radiated

Airborne sound comes from the inlets and exhausts of air ducts, directly from exposed equipment, or from sound leaking through air passageways or gaps. This type of sound can be controlled using mufflers or silencers for broadband noise, resonators for narrow band noise, active acoustic control systems inside the duct, applications of sound-absorbing materials in the duct lining, and by the use of appropriate materials to seal the gaps or otherwise block the noise.

Structure-borne noise is that noise transmitted by structural vibrations, and the resultant energy transfer at mountings, connections, and from surfaces. This noise can be reduced by the use of vibration isolators, active vibration control systems, applications of passive or active damping materials, and by the decoupling of lines to preclude the transfer of vibration.

Enclosure-radiated sound is that sound radiated from, or transmitted through structural enclosures, panels, shelves, and other types of closeout materials. This noise contribution can be lowered by material changes, the addition of barrier or stiffening materials to reduce transmission, the addition of damping or viscoelastic materials to minimize radiation, addition of absorbent materials inside the enclosure to absorb acoustic energy, or through the use of active structural acoustic control.

6.6.4.1.4 Noise at the Receiver Location

The acoustic environment in the receiving space is affected by the volume, surface area, dimensions relative to the acoustic wavelength, ratio of the dimensions, reverberation time, and absorption properties of the crew compartment. At higher frequencies, where the sound pressure level in the reverberant field can be assumed constant, the noise in the receiving space is best controlled by increasing the absorption coefficient of the bounding surface areas.

The application of these absorption materials to the interior surfaces of the crew habitat can be limited in use because of flammability, outgassing, wear-and-tear resistance, and other properties

of the material. Although porous acoustic materials often have good sound-absorbing properties, they might not be suitable for use within the crew compartment if they either particulate, or collect moisture, dirt, or other contaminants detrimental to the health and well-being of the inhabitants. If their use is necessary, these materials need to be covered or contained such that the concerns are remedied, and good absorption properties are maintained.

At the lower frequencies, a noise control strategy can be based on active acoustic control if the application can be made practical using reliable hardware and robust control software. The design should address redundancy and mitigation measures relating to a possible failure of the active control system. The acoustic environment in the crew compartment or habitat should be controlled at all potential receiver locations. At crew receiver locations, other approaches for reducing the sound pressure levels or changing the effects of the factors described are limited. Options at the receiver are to enclose the receiver, move the receiver, or require that the receiver wear hearing protection.

If the receiver acoustic levels are too high because the predicted or measured levels have been underestimated or not understood adequately, the remedial alternatives lead back to reducing emissions from the noise sources or along the paths to the receiver. This is all the more reason why early testing of the crew compartment with the basic systems installed should be performed to ensure that problems can be found and quantified, and that appropriate remedial actions can be implemented in a timely fashion. When this assessment is postponed until late in the flow schedule, any noncompliance discovered at that time will more severely impact the design and delivery schedules. Remedial action then will prove to be more difficult and costly. The noise control plan and the program flow schedules should include time for this valuable effort, and it should be conducted as early in the program as possible.

The option of moving the receiver is practical only if the crew can be relocated to areas not affected by the higher noise levels. By providing separate sleeping quarters, the crewmembers can be isolated from noise that otherwise would disturb their rest or sleep cycles. Controlling the noise directly at the ear of the receiver usually is not acceptable because the levels would be tolerable only with the use of hearing protection. Exceptions can be made for short-duration events such as cabin depressurization, the launch sequence, or some segments during the descent of the space vehicle.

6.6.4.1.5 Acoustic Analysis

An acoustic analysis is an important part of the noise control plan because its predictions provide an estimate for the resultant noise levels in the crew compartment habitat throughout the design phase. The acoustic analysis should be based on a semiempirical approach, in which possibly inaccurate estimates or assumptions, calculations, and procedures in the analysis can be replaced by validated test results. The analyses should be performed at the component or assembly levels of the contributing sources, and along their paths to the receiver location. The purpose of the semiempirical acoustic analysis is to have a continuously updated and documented assessment of the acoustic environment as it relates to compliance with the requirements, and to provide insight and understanding of the underlying acoustic principles, thus allowing a basis for efficient and effective noise control implementation.

The first step in estimating the noise environment is to quantify the sound power of the noise sources to determine which measures need to be implemented along the pathways to the receiver location, and to establish priorities for noise control efforts. Analysis and testing should be maximized to provide updated information on source, path, and receiver information. Breadboard testing or piggyback testing on major noise source subsystems should be used to expose acoustic effects, and the actual noise levels should be used to update the analysis.

A variety of tools are available for the acoustic analyses, each of which has advantages and disadvantages depending on the frequency range of interest, the computational and financial resources available, the accuracy required, the type of source, the nature of the noise paths, and the characterization of the receiving space. Tools include the use of analytic formulas, geometric computer-aided design (CAD) models, finite element and boundary element codes, acoustic ray tracing programs (Pilkinton & Denham, 2005), statistical energy analysis programs (Chu & Allen, 2011), technical and mathematical computing languages, and the traditional programming languages.

6.6.4.1.6 Testing and Verification

Sound power and directivity measurements of noise sources need to be performed, and the results should be used to determine possible quieting approaches. Simple mock-ups or prototypes can be employed to determine, inexpensively, the effectiveness of mufflers or other noise reduction devices. Testing of the designs and design approaches should be performed as much as possible prior to formal verification testing to minimize unforeseen results, provide time for remedial actions if required, and supply a basis for updating of the analysis to reflect test results. Acoustic measurements should be included in the breadboard testing of systems (e.g., the environmental control system).

It is important to operate each equipment item individually to determine its noise contribution and frequency content relative to the total noise levels. This provides information for the ranking of the contributing sound sources in selected frequency bands, and helps establish priorities for the work to be done. Testing setup, conditions, instrumentation, procedures, and results should be included or referenced in the noise control plan, and implemented accordingly. As noted previously, it is recommended to allow for early testing so that time is available for remedial action with minimized impacts. Verification is very important in that it defines how and what needs to be done to prove that the requirements have been met. Verification needs to address the testing, demonstrations, analysis, and equipment and programs used in the verification process.

6.6.4.2 Noise Control Design Applications

The noise control plan should define the approach to be used, and the efforts needed to control the noise at the source, path, and receiver. A good approach would be to identify all continuous noise sources; determine the source to receiver paths; estimate the combined systems noise; determine the contribution of each source relative to the total noise; and specify the applicable noise criteria.

The flow chart in Figure 6.6-7 (Hill, 1992; Hill, 1994) for the Space Shuttle shows that the typical fan-powered source radiation consists of contributions from the aerodynamic noise emanating from the inlet and exhaust, contributions from the structure-borne vibration at the mounting interface, and noise from equipment enclosure radiation.

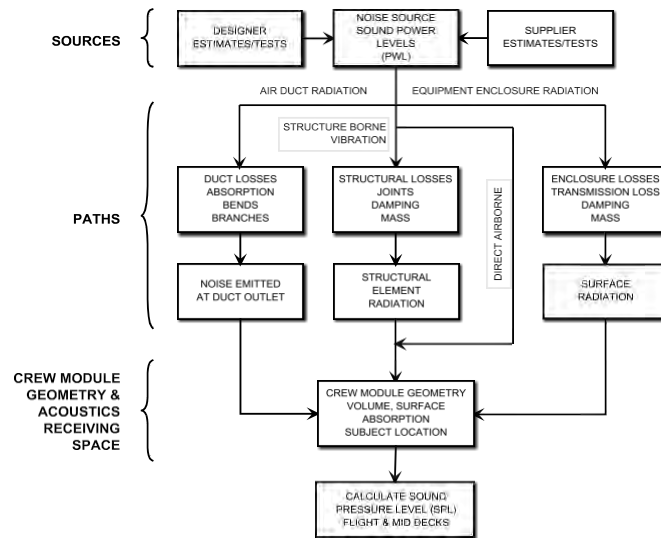


Figure 6.6-7 Space Shuttle approach to estimating continuous noise in the crew compartment.

The flow chart illustrates that the noise emitted at the duct outlet has already been reduced by losses within the duct due to absorption, and by the bends and branches of the duct. The structure-borne vibration is affected by structural losses, joints, and the mass and damping of the structural elements. Finally, the source surface radiation is dependent upon the enclosure losses, the transmission loss, and the mass, stiffness, and damping of the enclosure.

Typical noise paths aboard the Space Shuttle are shown in Figure 6.6-8 (Hill, 1992). In the Space Shuttle and the ISS, the noise permitted in the habitable environment is controlled by budgeting allocations to the equipment sources and the noise pathways. European modules for the ISS use a somewhat different approach. Budgets are established for the allowable sound power of hardware systems. The sound power contributions of these sources are then determined, and any necessary pathway reduction efforts using testing or a database of prior testing are implemented. Module systems tests are used to verify compliance (Destafanis & Marucchi-Chierro, 2002).

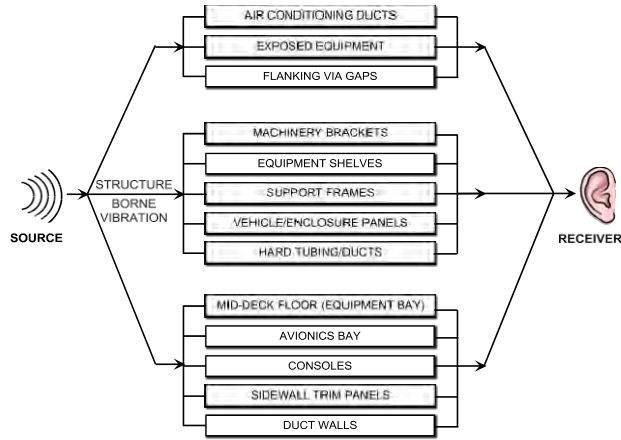


Figure 6.6-8 Space Shuttle noise paths.

6.6.4.2.1 Noise Control at the Source

Fans are the dominant noise sources within space vehicles and habitats. Fan design is a trade-off involving many factors that must be matched including fan source noise, power *versus* frequency requirements, and size as a function of speed (O’Conner, 1995). Fan balance, blade shape, bearings, and motor design are some areas where improvements can be made to lower the noise. Reducing the fan speeds or voltage has been used where feasible to lower the noise emission levels.

Pumps, compressors, and other notable noise sources need to be attended to in the same manner. Applying resources and technology early in a program to obtain quiet noise sources is recommended.

6.6.4.2.2 Path Noise Control

Noisy fans generate excessive airborne noise in air duct inlets and exhausts that is transmitted into the crew compartment. Inlet and outlet mufflers are commonly used accessories on the ISS to lower noise produced by fans. A muffler or silencer used at the intermodule ventilation fan inlet and outlet in the US segment of the ISS is shown in Figure 6.6-9. The muffler or silencer is lined inside with a feltmetal (a micron-size fiber sinter bonded into continuous felt) screen covering applied over absorbent foam material. The European modules use similar mufflers.



Figure 6.6-9 ISS US Laboratory intermodule ventilation fan muffler.

Considerable noise concerns existed for the Space Shuttle before its first flight, and GFE mufflers were developed to quiet the effects of the most dominant noise source – the inertial measurement unit fans (Figure 6.6-10).

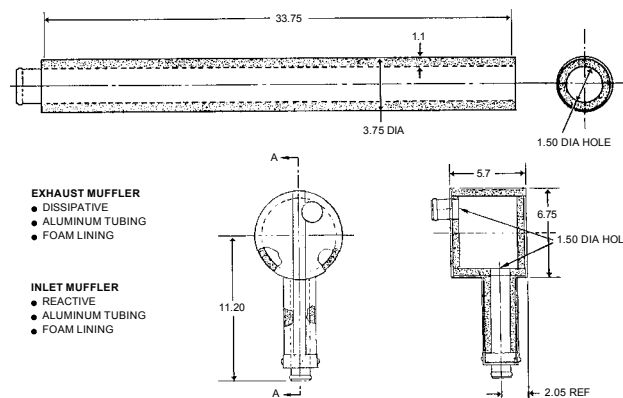


Figure 6.6-10 Space Shuttle inertial measurement unit cooling fan mufflers.

The acoustic benefits for the use of the GFE foam lined reactive and dissipative muffler designs is shown in Figure 6.6-11 (Hill, 1994). These GFE mufflers subsequently were changed from the four individual mufflers (three inlets and one outlet), to one unified muffler.

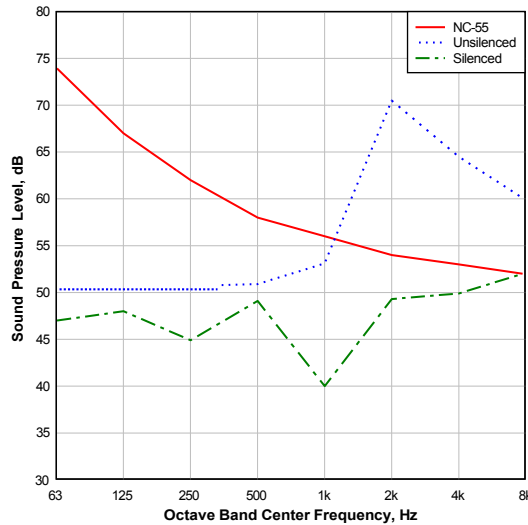


Figure 6.6-11 Space Shuttle inertial measurement unit muffler attenuation.

For the ISS Functional Cargo Block, NASA developed a unique muffler (Figure 6.6-12) incorporating improved flow, noise barrier, absorption, and Helmholtz resonator concepts that reduced both broadband and narrow band noise (Grosveld & Goodman, 2003). Reserving an envelope and provisioning for future addition of mufflers (scaring) should be considered in the design of space systems so that, if needed, mufflers can be added later without major impacts. Air duct noise can be attenuated by improving the design of the ducts, bends, absorbent liners, and the design of diffusers or grills that draw air in or let it out.

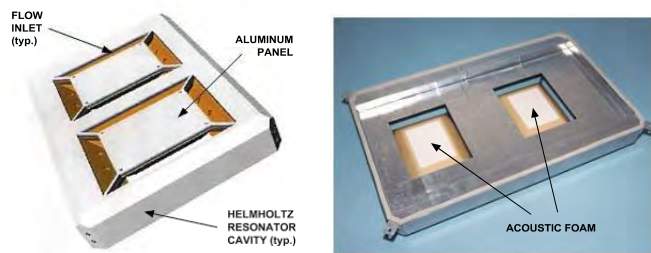


Figure 6.6-12 NASA muffler for the Functional Cargo Block.

The air-flow passageways to and from fans can produce noise because of restrictions and turbulent flow. They, therefore, can raise the total fan-related noise. Acoustically treated devices, termed splitters, with Helmholtz resonators tuned to attenuate fan inlet or outlet noise can be added to attenuate duct noise (Denham & Kidd, 1996).

If a source, such as a fan, cannot be quieted by design, then strong consideration should be given to the use of a unified package that attenuates airborne emissions by using mufflers, attenuating case-radiated noise by barrier applications, and reducing structure-borne noise by the

implementation of isolation or anti-vibration mounts. A good example of a system for which most of these features have been implemented is shown in an Avionics Air Assembly fan package used in the US Laboratory (Figure 6.6-13).

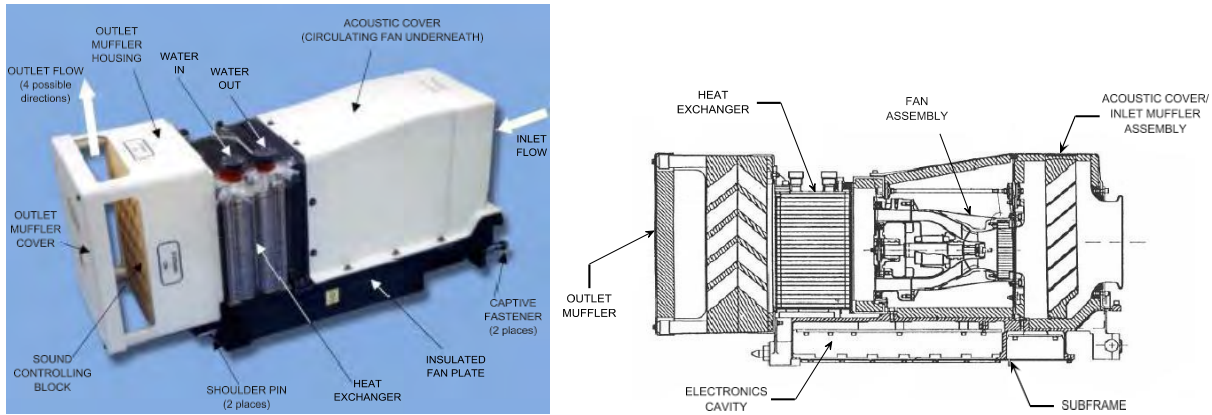


Figure 6.6-13 ISS Avionics Air Assembly fan and packaging.

Use of vibration isolation is strongly recommended to control structure-borne noise by mechanically isolating fans, motors, pumps, compressors, other major noise sources, as well as attaching ducting and lines to them. Vibration paths in ducting-to-ducting or fan-to-ducting connections can be reduced by using rubber-type booties for connections. Vibration isolators are used widely in the Space Shuttle and in the ISS.

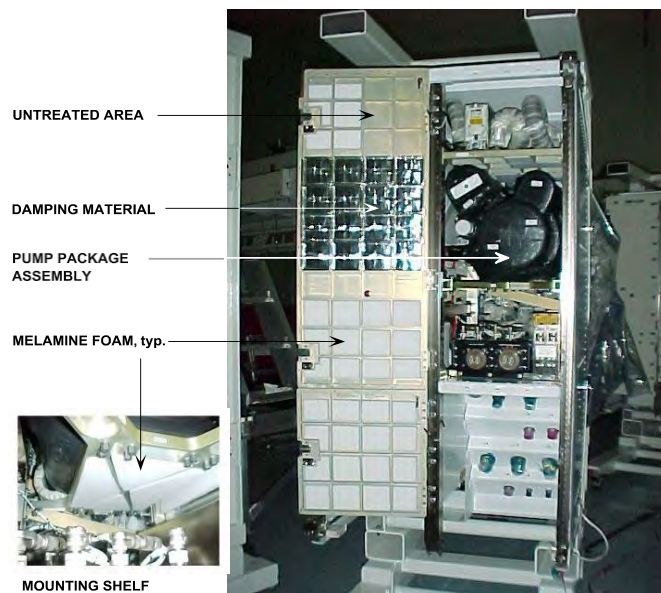


Figure 6.6-14 ISS Rack with Pump Package Assembly.

To reduce enclosure radiation, acoustic foam has been effectively used inside a large number of ISS module and payload racks to absorb and thus lower noise levels inside the racks. Figure 6.6-14 shows foam added to the Pump Package Assembly rack interior door and to the underside of the Pump Package Assembly mounting shelf, as well as the damping material added to the inside face of the rack door to reduce vibrations.

Barriers have been used on enclosures or as wraps around ducting to reduce radiated noise. These applications were used in the quieting of the ducting in the Minus Eighty Degree Laboratory Freezer payload rack (Figure 6.6-15; Tang, Goodman, & Allen, 2003).

Various types of materials and material lay-ups have been employed to reduce emissions through rack front faces or structural closeouts, or simply as closeouts. Materials are very important in acoustic applications; it is essential to have space-qualified materials with good acoustic properties available.

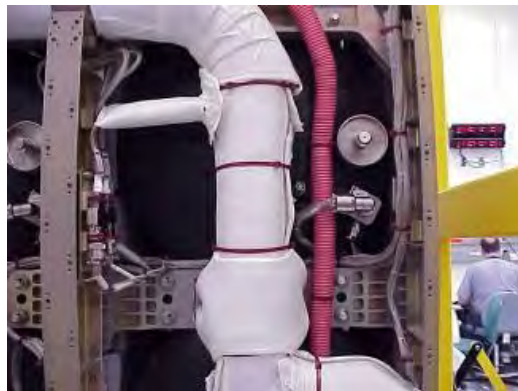


Figure 6.6-15 Duct wrapping of the Minus Eighty Degree Laboratory Freezer.

6.6.4.2.3 Noise Control in the Receiving Space

Applications of foam end cone cushions were considered for use in the US Laboratory as a way to help lower acoustic levels by changing the absorption properties of the module and the related room coefficient. Results are shown in Figure 6.6-16. This approach, although beneficial, was not used because of concerns with the cushions being damaged and contents coming out during on-orbit operations. This subject matter is worthy of further consideration to improve the surface absorption, if surfaces can be made durable and reliable.

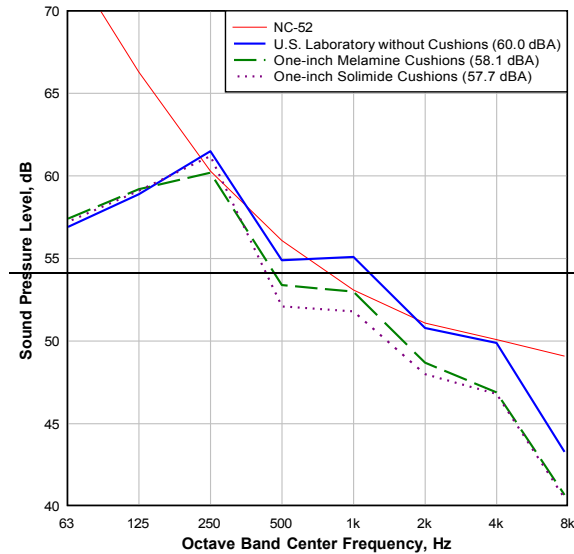


Figure 6.6-16 US Laboratory Melamine[®] and Solimide[®] absorbing cushion applications

To provide acceptable sound pressure levels at the receiver is to provide special isolating enclosures like sleep stations for use by the crew during periods of rest and sleep. This approach was used in the Space Shuttle and the ISS. Such enclosures, generally designed into the crew compartment or added later as a kit, accommodate the need for lower noise levels for rest and sleep. The provision of special, closed-off areas for exercise is an approach to lower the noise exposure to crewmembers who are not exercising. In other cases, systems can be turned off or flows can be diminished if such adjustments are acceptable. The use of hearing protection devices for launch and entry, and during limited applications, also is an acceptable way to control levels at the receiver locations, but only for relatively short durations. Such hearing protection devices have been used in Apollo, Space Shuttle, ISS, and other space programs. As can be seen from these examples, options for reducing noise at the receiver are limited, which is why efforts need to be focused and expended on effective source and path measures.

6.6.4.2.4 Post-Design Mitigation

Noise control is most effective when it is implemented as part of a normal design effort, and it should be approached in that manner. A good example of this is the Amine Swingbed payload quieting efforts (Welsh, Smith, Wang, & Allen, 2011).

When mitigation efforts are required to remedy an unacceptable noise situation after design completion, there is risk of considerable impacts being made to development, costs, and schedules (Tang, Goodman, & Allen, 2003). It also can be that late mitigation is only partially effective because the design or impacts preclude a more effective remedy. If noise mitigation has to be performed while the vehicle is on-orbit or on-route, then this becomes a very difficult and expensive effort, and the solutions may not produce an optimal result (Allen & Denham,

2011). To avoid these problems, acoustics should be considered and designed into the space vehicle crew compartments and habitats early in their development phases.

6.6.5 Verification of Acoustic Requirements

RESERVED.

6.6.6 Acoustic Monitoring of Spacecraft

To monitor, troubleshoot, and possibly remedy problems with hardware acoustic emissions during space flight missions, acoustic environmental monitoring must be performed, and acoustic measurement devices must be available. Both sound-level meter and personal noise dosimeter functions are required.

The purpose of the sound-level meter is to measure and monitor noise levels at specific locations over a short averaging time, e.g., 20 seconds, so that comparisons with the continuous noise can be made and other requirements met. Evaluations of noise-control treatments can also be performed. Sound-level meters measure sound pressure levels as a function of frequency as well as A-weighted and unweighted sound pressure levels.

Sound-level meters must measure time-averaged equivalent sound pressure levels with an accuracy of Type 1 as specified in ANSI S1.43-1997 (R2002), “Specifications for Integrating-Averaging Sound Level Meters,” or IEC 61672-1, “Electroacoustics – Sound Level Meters – Part 1: Specifications” in the audible frequency range from the 31.5-Hz octave band to the 10-kHz octave band.

Sound-level meter measurements should also have fractional octave-band filtering capability that meets Order 3, Type 1-D classification or better as specified in ANSI S1.11-1986 (ASA 65-1986), “Specifications for Octave Band and Fractional Octave Band Analog and Digital Filters,” or the Class 1 classification or better as specified in IEC 1260-1995, “Electroacoustics – Octave-band and fractional-octave-band filters.”

The purpose of the personal noise dosimeter is to measure and monitor crew noise exposure levels over long periods, e.g., a time-weighted average over 24 hours. Noise-exposure measurements at specified locations can also be acquired for extended time durations. Noise-exposure measurements will allow assessment of the overall environment including all sources of noise (e.g., continuous, intermittent, voice communications). Comparisons of noise-exposure levels to flight rules are often used to determine whether hearing-protective devices are required or whether measures must be performed to reduce the noise levels. Dosimeters also provide instantaneous A-weighted sound levels if a quick measurement is needed.

Personal noise dosimeter measurements must measure the time-averaged, equivalent A-weighted sound-pressure level with an accuracy of 2AS or better in accordance with ANSI 1.25.1991, “ANSI Specification for Personal Noise Dosimeters.” Logging dosimeters are recommended since they provide sound levels as a function of time, and this information can be used to identify loud (or quiet) activities, locations, or hardware operations.

6.6.7 Acoustic Countermeasures – Hearing Protection

RESERVED.

6.6.8 Acoustics Definitions

The following are terms commonly used when defining or discussing acoustic environments. See S1.1-1994 for more terms and definitions.

- Band sound-pressure level – Nonweighted sound-pressure level within a specified frequency range, e.g., octave band sound-pressure level, 1/3-octave band sound-pressure level.
- Broadband noise – Sound with energy distributed across a large frequency range, e.g., white noise, pink noise.
- Continuous noise – Noise that exists in a steady state for durations of 8 hours or longer in a 24-hour period. Typical continuous sources of noise include environmental control equipment and avionics equipment (e.g., fans, pumps, ventilation systems).
- Impulse noise – A burst of noise that is at least 10 dB above the background noise, which exists for 1 second or less.
- Intermittent noise – Noise that is generated for operational durations of less than 8 hours in a 24-hour period. Typical intermittent sources of noise are waste control system components (pumps, fans, separators, valves), exercise equipment (treadmill, cycle ergometer), galley fans, personal hygiene station components (pumps, fans, valves), and pressure regulators.
- Sound level – Same as weighted sound-pressure level or weighted sound level. When unqualified, “sound level” is understood to mean A-weighted sound pressure level.
- Sound-pressure level – Nonweighted sound-pressure level. Same as “overall sound-pressure level,” which is old terminology that is not included in ANSI S1.1-1994, “Acoustical Terminology.”
- Signal-to-noise ratio – Ten times the logarithm (base 10) of the ratio of the signal power to the noise power. In decibels, the signal-to-noise ratio is the difference between the signal and noise sound-pressure levels.
- Tonal or narrow-band noise – Sound with energy at a single frequency or distributed across a relatively small section of the frequency range. The opposite of broadband noise.

6.6.9 Research Needs

- Advanced, automated acoustic monitoring systems with remote operational control and data transfer.
- Real-time acoustic monitoring with high-level alert capability.
- Quiet fan and pump design and development technology.
- Improved absorptive wall treatments and other acoustic materials that meet spaceflight requirements (e.g., off-gassing, flammability, particulate generation, friability)

6.7 VIBRATION

6.7.1 Background

6.7.1.1 Scope

This chapter provides design considerations, guidelines, and examples specifically for vibration encountered in the spaceflight environment. Webb (1964), Roth and Chambers (1968), Guignard and King (1972), Hornick (1973), Boff and Lincoln (1988), Griffin (1990), Mansfield (2005), and Smith et al. (2008) provide comprehensive surveys of the extensive research literature spanning the human health, performance, and perception concerns that arise from vibration in aerospace and other occupational applications. Current (e.g., MIL-STD-1472G, 2012) and prior (e.g., MSFC-STD-267A, 1966) standards enumerate restrictions and offer guidance for the construction and use of systems in vibration environments. This chapter revises and reorganizes the contents in NASA's Man Systems Integration Standards (NASA-STD-3000, 1995), incorporating current standards and practices for dealing with human vibration.

Vibratory environments, propagation of vibratory energies, human responses to vibration, and exposure criteria are included in this chapter. Low frequency vibration in the range of 0.1 to 0.5 Hz and higher frequency vibration from 0.5 to 80 Hz are examined separately. The lower range is discussed from the standpoint of motion sickness and its impact on performance. The higher frequency range is considered from the standpoint of health and injury as well as perceptual and motor performance impacts. Vibration control and protection from vibration are also covered.

6.7.1.1.1 Nomenclature

A mechanical object or system (including the human body or body segments) undergoing vibration moves in a fluctuating or reciprocating manner. Such movement occurs in response to time-varying external forces applied directly to the object or system or by structural transmission from adjacent components to which the object or system is mechanically coupled.

As shown in Figure 6.7-1, vibration may be simple, comprising a sine wave oscillation; it may be complex, comprising the sum of multiple sinusoids, each with its own single frequency; or it may be random in nature without a discernible temporal pattern. Vibration may also combine sinusoidal, complex, and random waveforms.

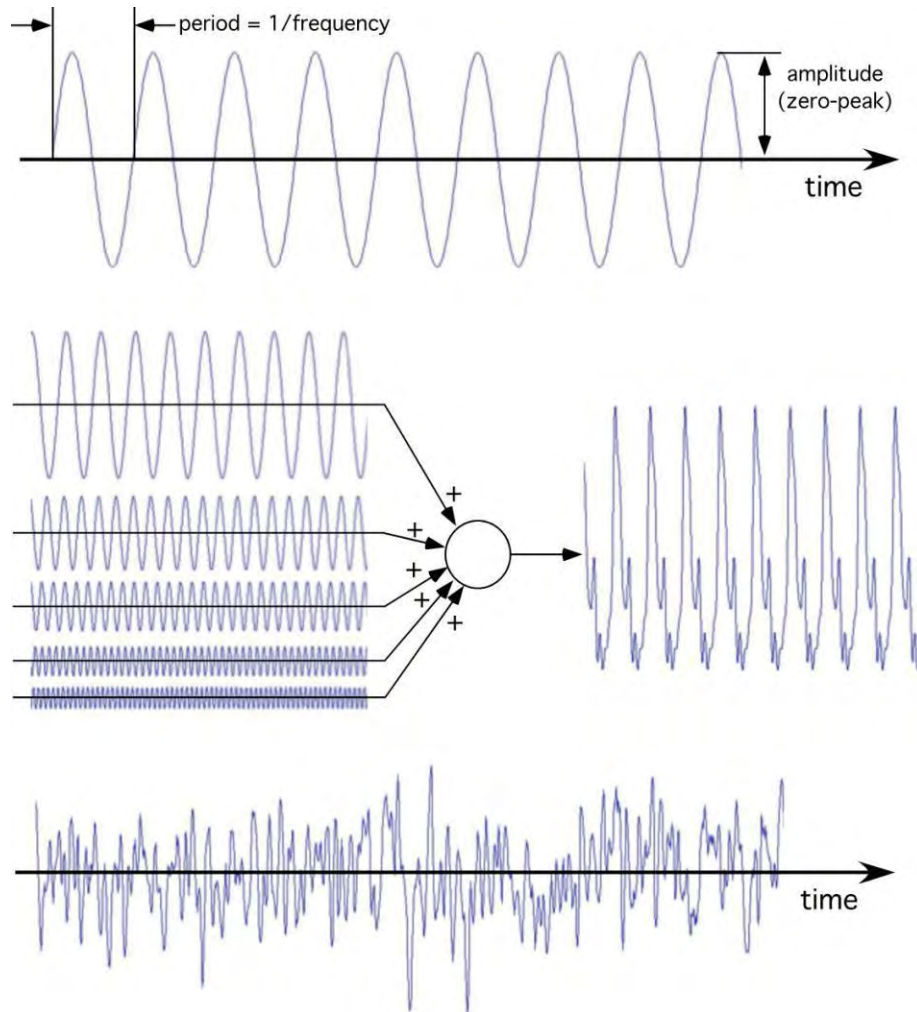


Figure 6.7-1 Examples of sinusoid (top), sum-of-sines (middle), and random (bottom) vibration waveforms.

Figure 6.7-1 (top) depicts a simple sine wave (or sinusoid) as an oscillatory movement, as a function of time that repeats itself after each oscillation cycle. The duration of a single cycle is the oscillation period represented in units of time (e.g., seconds, abbreviated as “s”). The inverse of the oscillation’s temporal period is its temporal frequency, historically in cycles-per-second (cps), which are equivalent to the currently employed unit, Hertz (Hz). The magnitude of sinusoidal vibration can be concisely quantified by the sine wave’s amplitude. For a zero-mean process “zero-to-peak” amplitude expresses the magnitude of the oscillation. Alternatively, the difference minimum (negative peak) to maximum (positive peak), or “peak-to-peak” amplitude may be used, especially for non-zero mean processes. The zero-to-peak amplitude is sometimes termed the “half-amplitude,” while the peak-to-peak amplitude is also called the “double amplitude.”

Complex waveforms can be characterized by the frequencies and amplitudes of their individual sinusoidal components, as well as by the relative timing between the components. An example summing five sinusoids with different frequencies, amplitudes, and relative cycle timing is illustrated in Figure 6.7-1 (middle).

The oscillation amplitude of individual sine components may be constant or time varying (either growing or diminishing in magnitude over a prolonged duration). The magnitude of any waveform may also be characterized by an averaging metric over a given temporal duration. The magnitude of sine, sum-of-sines, and random processes in both time-varying and invariant cases can be characterized in terms of their root-mean-square (RMS) amplitude. Typically, computing the RMS magnitude of vibration entails first subtracting out the mean value of the signal so that it becomes a zero-mean process, $x(t_k)$ ($k = 1, \dots, N$), representing the movement's variance, then squaring the amplitude of the sampled motion at each sample instant, t_k , averaging a number of the N squared samples covering the duration of interest, t_1 to t_N , and then taking the square root of the overall average, as described by Eq. 1.1,

$$RMS = \sqrt{\frac{1}{N} \sum_{k=1}^N [x(t_k)]^2} . \quad (\text{Eq. 1.1})$$

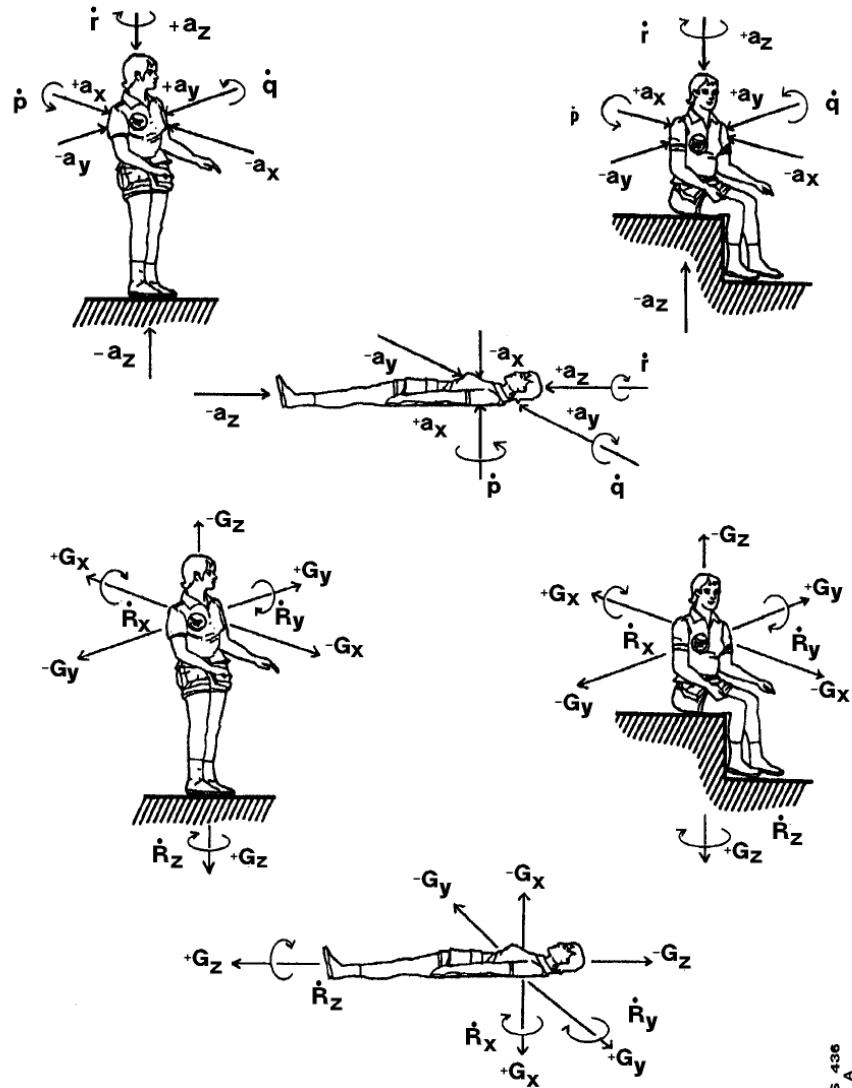
Vibration or oscillatory motion may be translational (i.e., rectilinear, linear) or rotational. Rotational oscillation produces translational components at a distance from the center of rotation (i.e., rotational axis). At the center of rotation (zero distance from the rotational axis), no translational motion is produced by rotation.

Vibration can be measured directly in terms of its acceleration, velocity, or displacement. Acceleration, velocity, and displacements may be converted from one format to another by mathematical integration or differentiation with respect to time. In this chapter, vibration quantities are expressed as acceleration. Throughout this chapter, lower case “g” is employed as the measurement unit for translational acceleration that is due to vibration or oscillation, where $1.0 \text{ g} = 9.80665 \text{ m/s}^2$. Upper case “G” represents units of acceleration for G-bias, the invariant or very slowly varying level of acceleration upon which the zero-mean vibration process is superimposed. Upper case “G” connotes the accelerations that produce the G-loading associated with space vehicle launch or the aerobatic maneuvers of high-performance aircraft.

Vibration can have multiple spatial components, where each component may be sinusoidal, complex, or random in nature. These spatial components can include the translations directed along three principle Cartesian axes as well as rotations about these three axes. The relative timing (or phase) between different components establishes a spatial shape for the vibration motion pattern. For example, in the special case where the vibration in all axes is identical and in phase, the vibrating object moves along a straight line. However, if single sinusoids in each axis are out of phase, the vibrating object may move in an elliptical pattern. If complex waveforms occur out of phase, the object may follow an intricate trajectory of multiple repeating (or if random, non-repeating) loops.

6.7.1.1.2 Coordinate Systems

The spatial components of vibratory (or any) motion can be described in a variety of coordinate frames. These coordinate frames can be referenced to a fixed-base (e.g., Earth), to a moving frame attached to the aerospace vehicle, or to one that is affixed to the human body. Figure 6.7-2 shows the body-based coordinate system nomenclature that is used in this chapter. This system is based on the direction that a body organ (e.g., the heart) would be displaced by acceleration. Table 6.7-1 explains the most commonly employed terms.



MSIS 436
Rev. A
1 of 2

Reference: 101, pg 9
Figure 5.3.1-1 Acceleration Environment Coordinate System Used in MSIS

Figure 6.7-2 Acceleration environment coordinate system.

1.1. Acceleration environment coordinate system used in this chapter.

Table 6.7-1 Commonly Used Terms

LINEAR MOTION	Direction of Acceleration		Inertial Resultant of Body Acceleration	
	Acting Force	Acceleration Description	Reaction Force	Verticular Description
Forward	+a _x	Forward accel.	+G _x	Eye Balls In
Backward	-a _x	Backward accel.	-G _x	Eye Balls Out
Upward	-a _z	Headward accel.	+G _z	Eye Balls Down
Downward	+a _z	Footward accel.	-G _z	Eye Balls Up
To Right	+a _y	R. Lateral accel.	+G _y	Eye Balls Left
To Left	-a _y	L. Lateral accel.	-G _y	Eye Balls Right
ANGULAR MOTION				
Roll Right	+ \dot{p}		- \dot{R}_x	Cartwheel
Roll Left	- \dot{p}		+ \dot{R}_x	
Pitch Up	+ \dot{q}		- \dot{R}_y	Somersault
Pitch Down	- \dot{q}		+ \dot{R}_y	
Yaw Right	+ \dot{r}		+ \dot{R}_z	Pirouette
Yaw Left	- \dot{r}		- \dot{R}_z	

FOOTNOTES

Large letter, G, used as unit to express inertial resultant to whole body acceleration in multiples of the magnitude of the acceleration of gravity. Acceleration of gravity, g₀, = 980,665 cm/sec² or 32.1739 ft/sec²

Reference: 380
With Updates

Figure 5.3.1-1 Acceleration Environment Coordinate System Used in MSIS

MSIS 436
Rev. A
2 of 2

Note: Upper case letter, G, expresses the inertial resultant to whole-body acceleration in multiples of the magnitude of the acceleration of gravity. The acceleration due to gravity, g, equals 9.80665 m/s².

6.7.1.2 Human Vibration in Spaceflight Environments

The vibration environment in space operations covers a wide range of amplitudes and frequencies. Vibration due to space module booster and control rockets, aerodynamic loading, cabin machinery, and equipment must all be considered. In addition, insecurely fastened stowed items can be a source of vibration.

Vibration seldom occurs in the operational situation as a single isolated variable. Other environmental variables such as weightlessness, linear acceleration, etc., can be expected to interact with vibration to reduce, increase, or alter the debilitating effects. Equipment variables include size of graduations or illumination of instruments, inflated pressure suits, etc.; procedural variables include task load, variations in time of performance, etc.; and, finally,

personal variables include fatigue and deconditioning, etc. The effects of some of these can be predicted at this time; others must await further research.

Studies of human response to vibration have been conducted in field environments and in complex laboratory simulations or experiments. However, most of the available information results from laboratory experiments.

The most useful information shows the effects of changing the characteristics of the vibration (magnitude, frequency, etc.), the influence of modifying the transmission of vibration to the body (by seating and postural alterations), the sources and extent of individual variability, and the effects of alterations to the operator's task.

6.7.1.2.1 Vibration Environment Considerations

Effects of vibration of the whole body are usually expressed in terms of vibration measured at the interface between the body and the vibrating surface. Vibration of displays and controls must also be assessed.

Vibration normal (i.e., perpendicular or orthogonal) to general support surfaces is most frequently of interest; however, other axes (i.e., tangential, binormal), rotations about these axes, and input locations can also be important.

All effects of vibration depend on vibration frequency. Some effects are restricted to narrow frequency ranges.

The preponderance of clinical observations concerning duration involves chronic low-level exposure in occupational settings, i.e., spanning many hours per day over many years. The vibration of spaceflight, typically associated with events such as launch and entry, is noteworthy for its elevated intensity, brevity, and infrequency of occurrence over the course of a career. The influence of vibration duration, especially short duration, has not been studied extensively. Current information shows small or inconsistent effects of duration on task performance. Depending on frequency content, duration of vibration may cause or exacerbate discomfort or motion sickness.

Vibratory environments have complex motions that vary greatly in magnitude, frequency, direction, and duration. Detailed analysis of motions (including spectral analysis) is required when considering motion effects. The motions may produce several different effects or one dominant effect.

6.7.1.2.2 Pre-Launch Phase Vibration Environment

Vertically stacked vehicle architectures are susceptible to wind loading on the launch pad, thereby producing horizontal deflection. Deflections for the crew vehicle at the top of the stack may be sizable and prolonged depending on weather conditions and system structural properties, including launch pad restraining systems. Concern typically arises for cyclic deflections, or sway, with low (0.1 to 0.5 Hz) frequency content that can precipitate motion sickness in crews on board the vehicle, awaiting launch.

6.7.1.2.3 Launch Phase Vibration Environment

Significant levels of vibration occur routinely in crewed vehicle operations during powered flight, such as launch to orbit. The vibration experienced by crewmembers is caused by aero-acoustic loading, propulsion systems, and interaction of these load sources with the launch and crew vehicle structure. Aero-acoustic vibration loading is typically at its maximum at the point during ascent when aerodynamic pressure is greatest. Vibration during launch is coupled with a significant linear acceleration bias.

All rocket launches from Project Mercury through the Space Shuttle Program produced launch vibration that could impede crew visual performance. Mercury astronauts complained that vibration during boost interfered with their vision. The Titan II rocket used for the Gemini program produced a liquid-oxygen (LOX) feed oscillation that resulted in tuned vibration at 11 Hz along the launch stack's longitudinal axis, corresponding to the semi-supine astronauts' body *x*-axis. Concern for this oscillation, termed POGO (named after the pogo stick), prompted the first dial reading, handling properties, and interface usability studies on a centrifuge combining vibration with launch G-loading that were conducted in 1963 in advance of the first Gemini crewed flights.

Vibration during the Apollo flights varied significantly with each phase of the flight. Measurements of large amplitude 5-7 Hz POGO oscillations during both unmanned Saturn-V test flights (Apollo 4 and 6) led to 1968 crew ground (i.e., 1-G bias) tests that determined the resulting couch vibration was too severe for Apollo astronauts to endure. These tests prompted modifications to the LOX delivery system on the Saturn first-stage motors prior to the first crewed Saturn-V launch at the end of that year. Subsequent Apollo flights, however, revealed higher frequency (16-20 Hz) pogo during second and third stage flight (Fenwick, 1992).

Although POGO was eliminated on the Shuttle, its launch – as with that of all preceding systems – produced notable broadband multi-axis vibration at the crew seats, beginning at main engine ignition, becoming most pronounced due to ground interaction as the vehicle cleared the tower, diminishing, rising slightly at peak dynamic pressure (max-Q), and tailing off after solid rocket booster separation. Crews have anecdotally noted differing levels of visual impairment, with one possible explanation being differences in mission payload mass and mass distribution.

In general, low-frequency vibration is at a maximum as the launch system shudders on the pad at the moment of liftoff, but this is of very short duration. The frequency of such vibration changes with the length and mass of the rocket.

In the case of solid rocket motor boosters, such as the Ares-I launch vehicle proposed for the Constellation Program, resonant burning in the emptying motor cavity produces rhythmic pressure variations, termed thrust oscillation, which produce narrowly tuned longitudinal vehicle vibration. Because the resonant cavity length grows as the solid fuel is consumed, the thrust oscillation vibration frequency tends to steadily decrease over the duration of a solid rocket stage's flight.

In all cases, significant, prolonged, and varying acceleration is associated with launch to orbit. Since crewmembers are typically seated in a semi-supine position with their body x -axis, in general, aligned with the direction of vehicle travel (i.e., aerospace x -axis), they experience G -loading in the chest-to-spine direction, which pushes them back into the seat during launch. Whereas the Shuttle orbiter's maximum G -loading ($+3.0 G_x$) occurred at orbit insertion well after the maximum vibration associated with aero-acoustic loading had ended, the Ares-I's highest G -loading ($+3.8 G_x$) would have occurred at the end of first stage flight, when thrust oscillation was predicted to be most severe.

Guidance corrections during launch or staging may also add low-frequency oscillations due to the resonant mechanical response of the vehicle caused by brief burn impulses.

6.7.1.2.4 On-Orbit Phase Vibration Environment

Vibration is minimal during orbital flight. The internal motors for pressurization, air conditioning, pumping systems, and exercise equipment are potential sources of vibration. Other structure-borne vibrations during orbital flight are difficult to predict. Moreover, crewmembers are not rigidly attached to the vehicle on orbit as they would be on launch when they are tightly restrained by safety harnesses and G -loading. Hence, this minimal vibration is unlikely to be transferred to the crew.

6.7.1.2.5 Entry, Descent, and Landing Phase Vibration Environments

As during the launch phase, the crew vehicle encounters substantial aerodynamic loading upon entry to the atmosphere, which can generate vibration. While significant vibration occurs during entry, its levels are less intense than during launch. Vibration during entry, however, is experienced by crews who may be deconditioned, and is combined with significant translational deceleration, which results in an eyeballs-in (chest-to-spine) G -bias for capsule-type vehicles and an eyeballs-up G -bias for upright-seated short-duration crews on winged vehicles, such as the Shuttle orbiter.

Lifting vehicles (e.g., Gemini, Apollo, Shuttle) operating under automated control are generally smooth compared with ballistic entry (e.g., Mercury). (Guignard & King, 1972, p. 20) However, low-frequency oscillation may occur if the entry angle is too steep during entry. (NASA-STD-3000, 1995) Simulations of skip-glide entry for Apollo lunar return showed the potential of a lifting vehicle to produce severe oscillations when under human-in-the-loop control. (Graves & Harpold, 1972)

Entry for capsule-type vehicle has been followed by parachute descent. Although parachute descents were said to be typically free of oscillation (Guignard & King, 1972, p. 20), mission summaries reveal that several Apollo descents underwent periods of moderate to violent oscillation during drogue chute deployment. Historically, NASA parachute descents terminated in water landings where astronauts were then subject to potential seasickness due to vehicle motion driven by ocean swell.

6.7.2 Health, Comfort, and Perception

6.7.2.1 Human Responses to Vibration

Vibration may affect crewmembers' performance and may produce physiological and biodynamic effects as well as subjective or annoyance effects. Whole-body vibration may also interact with acoustic noise and other environmental factors to cause stress and fatigue, and to degrade vigilance and performance.

6.7.2.2 Physiological Effects of Vibration

The physical responses of the body are primarily the result of the body, in effect, acting as a complex system of distributed inertia (mass) and nonlinear coupling impedance (elasticity and damping) in the low frequency range, i.e., up to 50 Hz. The mass and impedance of the body parts and organs may amplify vibration over certain frequency ranges and attenuate it over others in various portions of the body and across the entire body.

Vibration energy transferred from supporting structure to the crewmember is the primary determinant of human impacts, which can include physiological effects, discomfort, and decrements in performance. Frequencies that correspond to the resonances of organs and limbs can produce amplified motion of the resonant body component. Table 6.7-2 lists various parts of the body and the approximate frequency where mechanical resonance occurs at 1 G (Webb, 1964; Hornick, 1973; Boff & Lincoln, 1988, pp. 2076-2081; Brauer, 2006). Body resonant frequencies at higher G levels, however, have only been investigated in a small number of studies (Vykukal, 1968; Vogt et al., 1968, 1973). Moreover, resonant response frequency may depend on the orientation of the G-vector with respect to the body as well as body restraint systems.

Table 6.7-2 Body Components and Resonant Frequencies

Body component	Resonant Frequency (Hz)
Whole body, standing erect	5-12
Whole body, standing relaxed	4-5
Whole body, prone	3-4
Whole body, transverse	2
Whole body, sitting vertical	5-6
Head, relative to body	20-30
Head, sitting	2-8
Head/shoulder, standing	5 & 12
Head/shoulder, seated	4 -5
Eyeball	40-90
Eardrum	1000
Shoulder/head, transverse rib	2-3
Main torso	3-5
Shoulder, standing	4-6
Shoulder, seated	4
Limb motion	3-4
Hand	1-3
Hand and fingers	30-40
Thorax	3.5
Chest wall	60
Anterior chest	7-11
Spinal column	8
Thoraco-abdominal viscera (semi-supine)	7-8
Abdominal mass	4-8
Abdominal wall	5-8
Abdominal viscera	3-3.5
Pelvic area, semi-supine	8
Hip, standing	4
Hip, sitting	2-8
Foot, seated man	>10

6.7.2.3 Discomfort/Annoyance Effects of Vibration

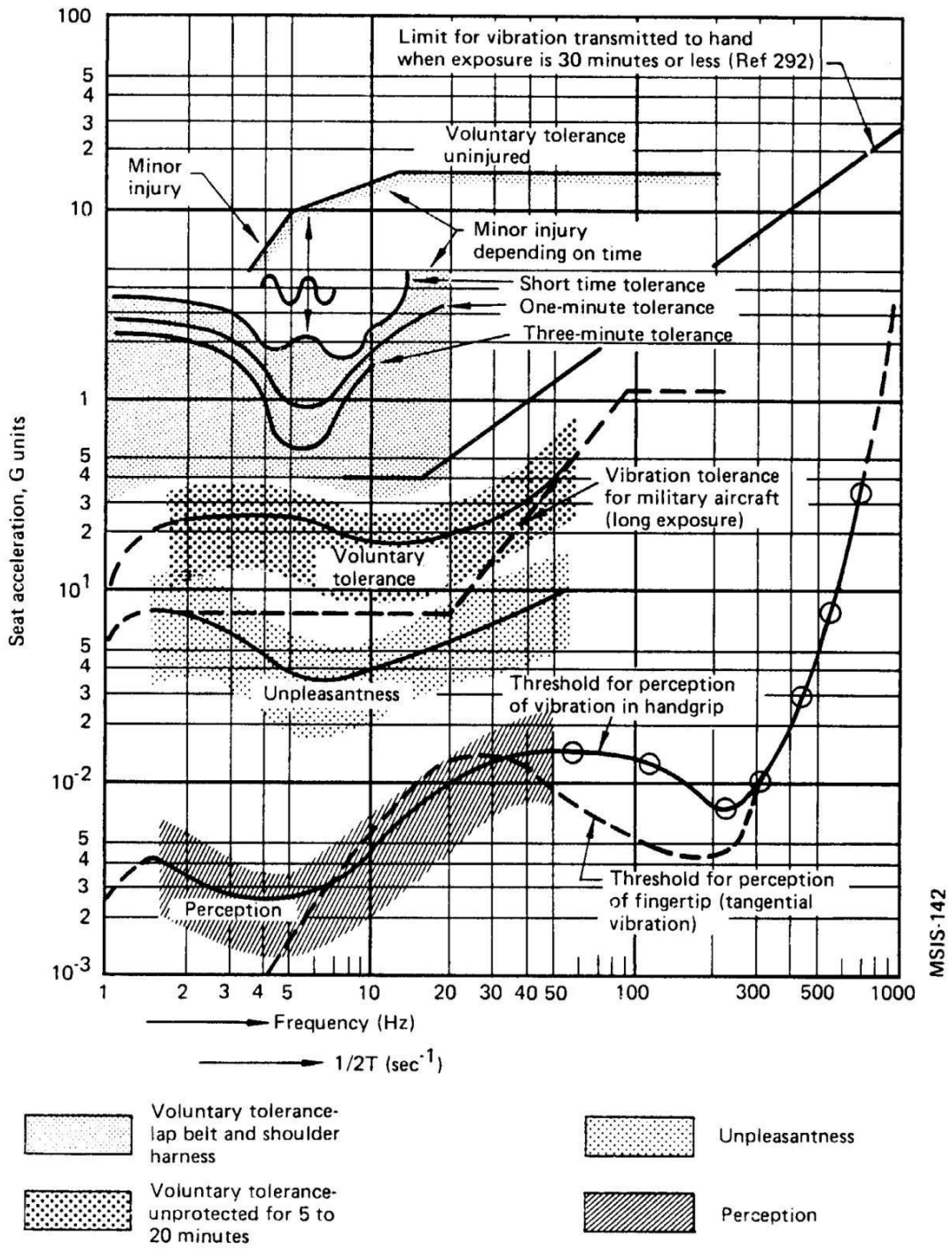
Excessive vibration can be unpleasant, painful, or even hazardous to health. In severe vibration environments, performance can be impaired because of pain or discomfort.

Motion sickness (kinetosis) is often caused by ≤ 0.5 Hz frequency vertical oscillation. The greatest sensitivity to vibration acceleration occurs between approximately 0.1 and 0.3 Hz. Vomiting incidence and illness is correlated with the acceleration magnitude of vibration in the body z-axis and increases slightly when other axes are included in the analysis. The proportion of persons becoming motion sick increases as the exposure duration increases.

The human perception threshold for 2- to 100-Hz vibration is approximately 0.015 m/s^2 RMS at the most sensitive frequencies (1-10 Hz) for whole-body vibration in all axes and most orientations of the body. (Griffin, 1990, Sec. 6.2; MIL-STD-1472G, 2012, p.160) Twenty-fifth percentile human perceptual thresholds are constant at this level when the vibration is W_k -weighted according to the frequency dependent weighting procedure described in Section 6.7.2.4. At vibration magnitudes above threshold, the discomfort (i.e., subjective magnitude) grows as the vibration magnitude increases.

Exposure of the entire body or parts of the body (e.g., limbs) to high magnitudes of continuous vibration or mechanical shock either directly or through contact with the surrounding environment due to flail can cause injury. The acceptable magnitude depends on several factors including the frequency, direction, duration, and point of contact with the body. General guidance is available, but the probability of specific injury due to given conditions cannot be calculated.

Figure 6.7-3 shows short-term vibration exposure boundaries as a function of acceleration and frequency from 1 to 1000 Hz (Webb, 1964). Unless otherwise stated, the vibration boundaries are for exposure times of 5 to 20 minutes, which covers the spacecraft launch and entry phases.



MSIS-142

Figure 5.5.2.3.3-1. Short-term Vibration Tolerance

Figure 6.7-3 Short-term vibration tolerance.

The short-time, 1-minute, and 3-minute exposures curves represented in Figure 6.7-3 are traceable to studies of maximum tolerable z -axis vibration conducted in the late 1950s and early 1960s for upright seat occupants in a $1-G_z$ Earth bias (Magid et al., 1960) that have not been repeated since. Maximum tolerance in those studies was defined as the amplitude at which volunteers terminated their exposure to a sinusoidal vibration of a specific frequency for reasons of severe discomfort, pain, or fear of injury. Studies to assess two candidate Apollo couch (semi-supine) seating designs yielded similar data for maximum tolerable body x -, y -, and z -axis vibration for semi-supine occupants also under $1-G_x$ Earth bias (Temple et al., 1964).

These historic short-duration maximum tolerance data underlie the International Standards Organization's (ISO 1997a) frequency-dependent weighting functions that support modern exposure and health guidance. Procedures for employing the ISO weighting and health guidance calculations are discussed below in Section 6.7.2.4.

It is known from limited studies combining vibration plus centrifuge loading that body segment and organ resonant frequencies typically increase as G -loading increases. (Vykukal, 1968; Vogt et al., 1968, 1973) These shifts will result in different frequency vibration sensitivities, which will change the historical maximum tolerance curves underlying the ISO frequency weightings (ISO, 2001). It is important to note that similar maximum tolerance data were never collected for vibration superimposed on the elevated G -loads associated with launch and entry, or for microgravity during orbit. Therefore, the changes in human tolerance as a function of oscillatory frequency resulting from the interaction of vibration with G -loading are presently not well understood. For example, G -loading might confer added immunity to vibration at some frequencies while enhancing its impact at others.

Table 6.7-3 lists some vibration discomfort symptoms and the range of frequencies of lowest tolerance at $1-G$ Earth bias. (Rasmussen, 1982, p. 13; Webb, 1964; Roth, 1968; Smith et al., 2008; Begault, 2011) The tabulated discomfort symptoms associated with specific narrow frequency ranges result from participant complaints elicited during the early (e.g., Magid et al., 1960; Temple et al., 1964) human vibration tolerance studies. These discomfort symptoms therefore guide the shape of the tolerance curves shown in Figure 6.7-3. Furthermore, the discomfort symptom frequencies can also be associated with body part resonances such as those enumerated in Table 6.7-3.

Table 6.7-3 Vibration Frequencies for Discomfort Symptoms

Symptom	Frequency (Hz)
General discomfort	1 - 50
Motion sickness	0.1 - 0.5
Abdominal pains	3 - 10
Chest pain	3 - 9
Lumbrosacral pain	8 - 12
Skeleto-muscular discomfort	3 - 8
Head symptoms	13 - 20
Lower jaw symptoms	6 - 8
Influence on speech	12 - 20
"Lump in throat"	12 - 16
Urge to urinate	10 - 18
Influence on breathing	4 - 8
Muscle contractions	4 - 9
Muscle tone	13-20
Valsalva	4 - 10
Testicular pain	10
Dyspnea	1 - 4
Other respiration	4-9

6.7.2.4 Weighted Vibration for Health Limits, Discomfort, and Motion Sickness

Because of differences in body segment resonant frequencies and relative differences in sensitivity to vibration at each of these resonances, human tolerance of vibration depends on oscillatory frequency. These frequency-dependent tolerances vary also with the duration of vibration exposure. Over a given 24-hour period, the total vibration is cumulative, effectively taking the form of a daily dosage. Relative sensitivities between frequencies or durations may also vary nonlinearly with vibration amplitude.

Sensitivities as a function of frequency are traceable to historical tolerance data (e.g., Magid et al., 1960; Temple et al., 1964), i.e., the maximum vibration amplitude or duration an observer is willing to accept, before requesting termination of the exposure. Data resulting from these studies for vibration in the body z-axis are summarized specifically by the tolerance contours in Figure 6.7-3. Similar data were collected for the body x-, y-, and z-axes from semi-supine subjects in an investigation of vibration tolerance a Project Mercury contoured couch and an adjustable seating concept that was being considered for the Apollo crew vehicle (Temple et al., 1964).

The aforementioned historical tolerance limits were subsequently combined with data on comfort and fatigue to arrive at the frequency-dependent relations representing the current understanding of human sensitivity and tolerance to vibration found in modern standards.

Prior versions of the ISO standard on “Mechanical vibration and shock-Evaluation of human exposure to whole-body vibration,” summarized by Griffin (1990) and Rasmussen (1982), as well as previous NASA Standards (NASA-STD-3000, 1995; Wheelwright, 1981) plotted these tolerances as families of individual frequency-dependent curves that delineate “fatigue-decreased proficiency boundaries” The individual curve shapes were derived in a Bode plot frequency-dependent format by fitting a set of poles and zeros to concisely capture the fundamental shape of the proficiency boundaries. The families for a particular curve shape comprised the fatigue-decreased proficiency boundaries for a range of exposure durations. Within each family, the amplitude of the basic curve was shifted upward to indicate that greater vibration amplitudes could be tolerated for short exposures and downward for lesser amplitude at longer exposures.

The modern representation of these frequency-dependent proficiency boundaries is given in the form of weighting functions that are inversions of the tolerance curves (i.e., weighting = [1 / tolerance] as a function of frequency). The weighting is multiplied by the vibration’s raw acceleration amplitude (either measured or modeled) to estimate the resulting subjective impact on the human observer. This is similar to the concept of “A-weighting” for sound pressure levels, where the weighting takes into account the sensitivity (or tolerance) of the human listener at different acoustic frequencies. Thus, as shown for the three different weighting curves, W_k , W_d , and W_f , in Figure 6.7-4, the weighting is at a maximum level (i.e., 0 dB) in the frequency band where the human observer is most sensitive (equivalently, least tolerant) to vibration. At other frequencies, the same input vibration acceleration level is multiplied by a lower weighting gain to indicate that there is less subjective impact on the observer. Equivalently, because of the lower weighting at these frequencies, larger raw amplitude vibration can be applied while still achieving the same level of subjective impact on the human observer. Note that the weighting functions, W_k and W_d , are applicable for vibration frequency content between 0.5 and 80 Hz, whereas the function, W_f , is used between 0.1 and 0.5 Hz.

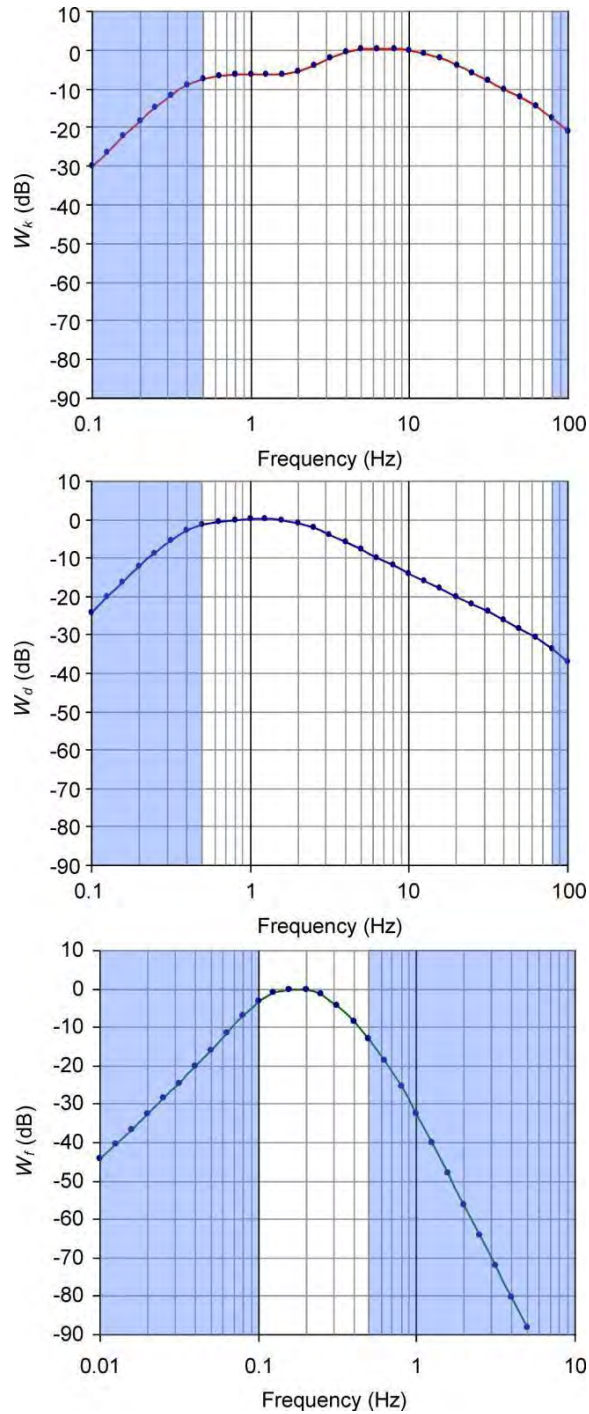


Figure 6.7-4 Frequency weighting functions: (top) W_k for body z-axis, (middle) W_d for body x- and y-axes, (bottom) W_f for motion sickness. Unshaded regions of each plot indicate applicable frequency range for each weighting function. [This adapted excerpt is taken from ISO 2631-1:1997, figure 2 on page 11, with the permission of ANSI on behalf of ISO. © ISO 2013 - All rights reserved]

For the purposes of assessing health and comfort limits, the weighting function, W_k , is used for vibration between 0.5 and 80 Hz in the body z-axis. W_d denotes the weighting for assessing

health and comfort for 0.5 and 80 Hz vibration in either the body y - or x -axes. On the other hand, to evaluate minimum perception thresholds, W_k is used in any of the three body axes.

For upright-seated occupants, the weighting function for the assessment of potential motion sickness (kinetosis), W_f , is applied for motion in the body z -axis at frequencies between 0.1 and 0.5 Hz. For occupants in a semi-supine posture, oscillation in all three body axes should be examined, subject to the same weighting function, W_f .

Numerical values for the weighting functions, W_k , W_d , and W_f , in Figure 6.7-4 are tabulated as functions of third-octave frequency bands in ISO 2631-1 (ISO, 1997a). Mathematical formulas to compute these weighting functions, effectively transfer functions, are also provided in ISO 2631-1.

Rectilinear vibrations transmitted to crewmembers should be measured or modeled directly in (or transformed into) the appropriate directions of an orthogonal coordinate system having its origin at the heart shown in Figure 6.7-2.

For calculations using the ISO weighting factors, input (raw) vibration in each body axis is first decomposed by spectral analysis or other means into the RMS acceleration associated with each of the tabulated third-octave frequency bands. Alternatively, the transfer function formulation can be used to scale each frequency component. The result in either case is the weighted RMS acceleration in each frequency band, which is squared, integrated across all frequency bands, and square-rooted to provide an overall weighted RMS acceleration for vibration in the particular body axis.

Variations in the intensity of vibration, including any intermittency or interruption of exposure that may occur, will have a cumulative effect on a crewmember's daily exposure (i.e., over each contiguous 24-hour period). If the exposure to vibration is interrupted by pauses during the working day, but the intensity of exposure remains the same, then the effective total daily exposure time is obtained by adding up the individual exposure time intervals. If the RMS acceleration amplitude varies appreciably with time, or if the total daily exposure is composed of several individual exposure intervals, then an equivalent total exposure can be determined as follows. In situations where the magnitude or frequency of the vibration is not constant, the square root of the time-based average of the mean-squared (squared RMS) vibration level is taken. In some instances, variations involved high-amplitude transient peaks – i.e., crest factors of 9 or greater – vibration dosage methods that compute the fourth-root of the time-based average of the mean-squared vibration level (ISO, 1997a).

Once the averaged weighted vibration is computed for each axis, an additional multiplicative weighting factor, k , is applied to the vibration in each axis depending on the purpose of the evaluation (i.e., health, comfort, or perception) and whether the observer is standing, seated, or recumbent. For example, for assessing health impacts on a seated occupant, including one in semi-supine seat during space launch, $k = 1.4$ is employed in conjunction with W_d for the body x - and y -axes, while $k = 1$ is used with W_k for the body z -axis. Effectively, the k factor accentuates sensitivity, elevating the prominence of vibration in the body x - and y -axes for health considerations. When evaluating comfort, $k = 1$ is applied in all axes, thereby equally

emphasized vibration in each body axis. Guidance on appropriate weighting factor selections as a function of body axes and posture is provided by ISO 2631-1 (ISO, 1997a).

The total vibration value is calculated by taking the root sum square of the three components (ISO, 1997a) after the appropriately weighted average RMS vibration has been computed for each body axis across the frequency band of interest. The resultant single total value is then used in the assessment of a given measured or modeled temporal and spatial vibration profile with respect to health, comfort, physical perception, and motion sickness limits. Based on the plotted values of 0.6 g (RMS weighted) for a 10-minute exposure in Figure 6.7-5, the constant value, $a_w^2 t = 0.06 \text{ g}^2/\text{hr}$ can be used to calculate the equivalent upper vibration limit boundary for longer daily exposures.

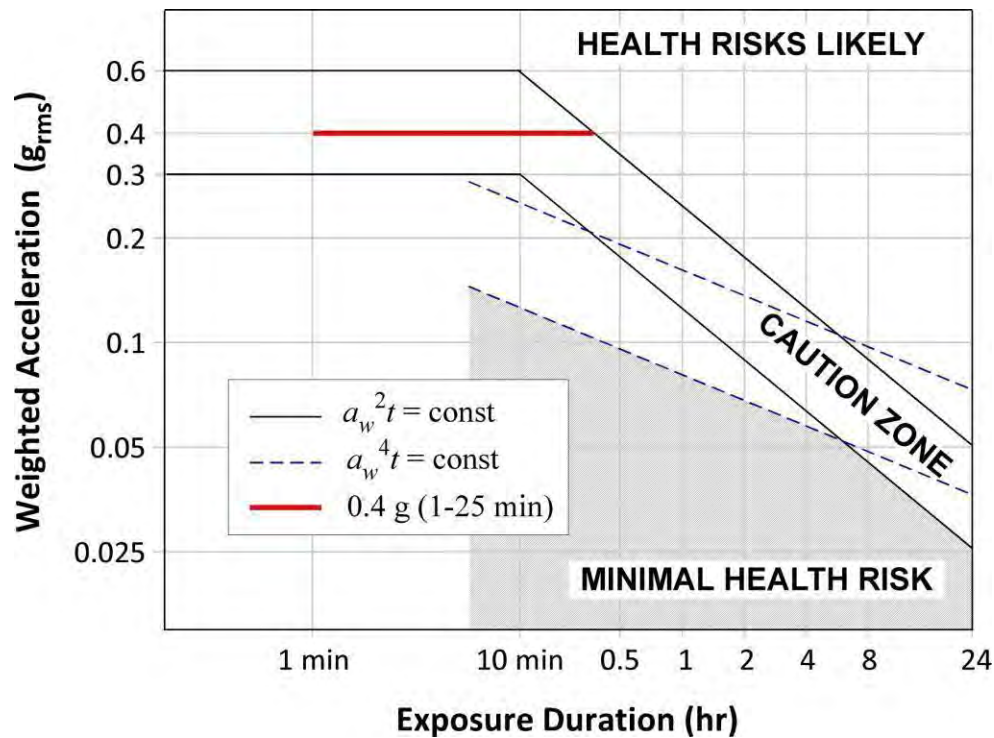


Figure 6.7-5 Vibration exposure health guidance. [This adapted excerpt is taken from ISO 2631-1:1997, figure B.1 on page 22, with the permission of ANSI on behalf of ISO. © ISO 2013 - All rights reserved.]

The preponderance of health-related data are from studies of prolonged occupational exposure lasting between 4 and 8 hours per day. Because the empirical data for brief (i.e., less than 10 minutes per day) intense vibration exposures are limited to a handful of tolerance (limits of instantaneous discomfort and pain) studies, ISO 2631-1 advises that “shorter durations should be treated with extreme caution.” Data from Earth-based (1-G bias) tests supporting the design of Apollo program crew seating concepts (Temple et al., 1964) indicate that short vibration exposures, between 1 and 10 minutes in duration, should be reduced to 0.4 g, which is shown in Figure 6.7-5 by the heavy red line from 1 to approximately 25 minutes.

Alternatively, as noted in Section 6.7.2.4, some situations indicate that equivalent vibration dose values can be computed as a function of the fourth power of weighted acceleration over time, i.e., $a_w^4 t = \text{constant}$. (ISO, 1997a) The dashed lines in Figure 6.7-5 delineate upper and lower

health boundaries based on the fourth-power formula. It can be seen that vibration boundaries provided by the square and fourth-power dosage methods are very similar for daily exposures between 4 and 8 hours. MIL-STD-1472G (2012) adopts the minimum of the lower $a_w^2 t$ and $a_w^4 t$ curves as the boundary below which health risks are considered minimal (shaded region in Figure 6.7-5), with the region between this lower boundary and the upper $a_w^2 t$ curve as the caution zone for potential health risks.

In all cases, health, comfort, and perceptual threshold comparisons with boundary levels for whole body vibration are to be made on the basis of the weighting, timing averaging, and axis summation procedures described above in Section 6.7.2.4.

Similar procedures, such as those outlined by the American National Standard S2.70-2006 (ANSI, 2006), are employed to assess the health impact of hand-transmitted vibration. While this standard targets the vibration arising from the use of powered hand tools (which has applicability to EVA and intravehicular activity (IVA) maintenance, repair, and assembly), it will be of lesser concern than whole-body vibration occurring during the dynamic phases of spaceflight.

6.7.2.4.1 Comparison with Historical Exposure Criteria Nomenclature

The following information is provided as reference to compare current health and comfort nomenclature with that used in earlier NASA and ISO standards documents.

a. Exposure Limit – Historically, the vibration acceleration exposure limit was set at approximately half the level considered to be the threshold of pain. This limit corresponds to the modern ISO-2631-1 health guidance as the vibration level at which “health risks are likely.”

b. Fatigue/Decreased-Proficiency Boundary – The vibration acceleration limit beyond which exposure can be regarded as carrying a significant risk of impaired working efficiency in many kinds of tasks is that in which fatigue is known to degrade performance. The fatigue, or decreased-proficiency, boundary limit is a function of frequency and exposure time and is one-half of the acceleration values given for the Exposure Limit. This boundary, therefore, corresponds to the modern ISO-2631-1 health guidance as the vibration level below which “health effects have not been clearly documented and/or objectively observed.”

Note that the term fatigue/decreased proficiency does not necessarily imply that all task performance is impaired by physiological fatigue, i.e., a time-dependent adverse effect due continuing vibration exposure. Many tasks or activities are instantaneously hampered by the presence of vibration. (ISO, 1997b).

c. Reduced Comfort Boundary – The vibration acceleration limit related to comfort and activities such as eating, reading, and writing. The reduced comfort boundary is one-third of the value of the Fatigue-Decreased Proficiency Boundary. Matters related to comfort while exposed to vibration are discussed in Section 6.7.2.5.

6.7.2.5 Comfort Limits (0.5 to 80 Hz)

Crewmember discomfort is not quantified on an absolute scale. A scale of comfort reactions to whole-body vibration, derived for public transport passengers, is provided in Table 6.7-4 (ISO, 1997a). Comparisons with levels in this table are to be made using frequency-weighted, time-averaged RMS accelerations described in Section 6.7.2.4. Thus, these weighted vibration levels can span a wide range of frequencies; that is, they correspond to a wide-band (i.e., 1-50 Hz) “general discomfort” rather than being focused in the narrow frequency bands associated with specific discomfort symptoms listed in Table 6.7-3 above.

Table 6.7-4 Discomfort Ratings [Adapted from (ISO, 1997a)]

RMS Vibration (Weighted per ISO-2631-1)	Rating
< 0.032 g	Not Uncomfortable
0.032 to 0.064 g	A Little Uncomfortable
0.051 to 0.101 g	Fairly Uncomfortable
0.082 to 0.163 g	Uncomfortable
0.127 to 0.255 g	Very Uncomfortable
> 0.204 g	Extremely Uncomfortable
> 0.4 g for 10 minute or less > 0.6 g for 1 minute or less	“Health risks are likely”

For example, a series of studies conducted at Ames Research Center (ARC) between 2008 and 2010 (Adelstein et al., 2009a,b, 2012) involving general population and astronaut office members employed seat-driven whole-body vibration at 12 Hz with amplitudes up to 0.7 g_x (zero-to-peak). These amplitudes are equivalent to 0.117 g RMS (ISO-weighted), levels that are deemed “uncomfortable” according to Table 6.7-4.

6.7.2.6 Low Frequency Vibration Limits (0.1 to 0.5 Hz)

Low-frequency vibration, especially in the range between 0.1 and 0.5 Hz, has the potential to cause motion sickness, even over relatively short exposure periods. Symptoms of motion sickness can range from pallor and dizziness up through nausea to vomiting and complete disability.

Such low-frequency oscillations may be encountered while the crew is in the vehicle during the pre-launch period or in supporting tower structures, given that the tall vehicle stack may be susceptible to back-and-forth swaying. In addition to design of the launch vehicle system and support structures, sway will depend on wind conditions. Similar oscillatory frequency content will also be generated according to sea-state in cases of water landing and recovery.

Reducing the amount of sway will prevent the onset of motion sickness during the pre-launch phase. Avoidance of rough sea-states or reduction of exposure time may mitigate motion sickness for water landings.

The reduced comfort boundary for 0.1 to 0.5 Hz is vibration acceleration level at which the onset of various feelings of discomfort occurs. The decreased proficiency boundary is that limit of vibration acceleration where manual dexterity is impaired. The acceptable degree of impairment and corresponding acceleration levels will vary greatly with the nature of the task.

6.7.2.6.1 Severe Discomfort Boundary (0.1 to 0.5 Hz)

For assessing vibration between 0.1 and 0.5 Hz, the Motion Sickness Dose Value (MSDV) is calculated as $MSDV = a_w t^{1/2}$, where a_w is the time-averaged RMS acceleration from each of the three axes calculated according to Section 6.7.2.4 for weighting factor, W_f , and t is the exposure time. (ISO, 1997a) It should be noted that the relation for MSDV indicates that a trade is possible between a_w and t in order to maintain a constant value for MSDV.

The percentage of individuals who may vomit is estimated by $K_m \cdot MSDV$, where $K_m = 1/3$. This relationship is applicable for exposures between 20 minutes and 6 hours, and for prevalence of vomiting up to 70%. For example, in this frequency band, a weighted motion of $a_w = 0.5 \text{ m/s}^2$ RMS over a 1-hour period may result in an incidence of vomiting of approximately 10%.

Following guidance from the previous NASA standards (NASA-STD-3000, 1995), MSDV-based acceleration limits must be reduced by 25% when pitch and roll modes of vibration exist under either 1-G bias conditions or on-orbit microgravity conditions. During the elevated G-bias of the launch phase, 0.1 - 0.5 Hz vibration must not exceed 90% of MSDV-based acceleration limits for 1-G bias acceleration.

6.7.2.6.2 Decreased Proficiency Boundary

Because of lack of data, the decreased proficiency boundaries for motion between 0.1 and 0.5 Hz in the x -, y -, and z -axes have yet to be specified for various tasks.

6.7.2.6.3 Reduced Comfort Boundary

Because of the lack of data and the variability of onset of various reduced comfort symptoms, boundaries are not specified at this time for 0.1 to 0.5 Hz motion.

6.7.3 Performance

6.7.3.1 Performance Impacts of Vibration

Vibration affects performance either by modifying perception or by influencing control movements. Frequencies that affect performance are shown in Table 6.7-5. (NASA-STD-3000, 1995; Roth, 1968; Boff & Lincoln, 1988; Griffin, 1990)

Table 6.7-5 Vibration Frequencies Affecting Human Performance

Activity	Frequency Range (Hz)
Equilibrium	30 - 300
Tactile sense	30 - 300
Speech	1 - 20
Head movement	6 - 8
Reading (text)	2 - 50
Visual tracking	0.25 - 30
Reading errors (instruments)	5 - 12
Manual tracking	3 - 8
Depth perception	25 - 40, 40 - 60
Hand grasping handle (Tactile sensation)	200 - 240
Visual task	9 - 50

6.7.3.2 Visual Performance Effects

The effect of vibration on performance depends on the source of the motion, type of motion, environmental conditions, response of the individual, and requirements placed on the individual.

Vibration that results in image motion at the retina will begin to cause image blur, whether the observed object is moving and the observer is stationary or vice versa. Eye-in-head and head-in-world motion due to direct mechanical transmission of vibration from supporting surfaces will cause image motion on the retina and potentially disrupt visual performance.

At low frequencies, observers employ the optokinetic (OKN) reflex (i.e., retinal image feedback) to follow slowly moving targets and maintain images that are spatially stabilized on the retina. Depending on the magnitude and predictability of visual target motion, observers can track image motion below about 1 Hz; faster saccadic movements may allow moving images to be tracked up to 2-3 Hz.

Up until approximately 8 Hz, the vestibular sensory apparatus, which measures head motion, drives eye-in-head rotations in opposition to head rotations via the vestibulo-ocular reflex (VOR) to stabilize gaze direction in world coordinates. At vibration frequencies above these values, these reflex mechanisms begin to fail and images will oscillate on the retina and appear to blur. It is unknown to what extent (frequency, amplitude, and direction) whole-body vibration in neurologically intact individuals can generate vestibular sensory inputs that, instead of stabilizing gaze, would trigger spurious eye motion that would diminish visual performance. For example, approximately 100-Hz vibration applied to the occipital bone will trigger nystagmus (involuntary eye movements) in many healthy individuals as well as those with vestibular impairment of various types, and is used as a differential diagnostic test for such damage (Park et al., 2007).

For moving Landolt-C targets, dynamic visual acuity is on the order of 2 arcmin or better for slow-moving targets and degrades (i.e., grows larger) as target velocity increases. This corresponds to a detection threshold for a vibrating target of at least ± 1 arcmin. Vibration amplitudes greater than ± 2 arcmin will, depending on the task, affect reading ability. Dynamic visual acuity for moving observers and stationary targets has similar thresholds. It has been suggested that, for a given angular vibration magnitude, observers undergoing vibration while viewing a stationary object will generally be more susceptible to vibration-induced visual degradation than stationary observers viewing vibrating objects. (The opposite can be true at lower frequencies where vibrating observers benefit more from the higher bandwidth of VOR for gaze stabilization than stationary observers from OKN for volitional tracking for comparable angular vibration amplitudes.)

Prediction of the visual performance decrements due to single-axis translational whole-body vibration is complicated by the fact that biodynamic transmission from the supporting surface through the body will produce head rotational components about various axes in addition to head motion along the original single axis. The biodynamic transmission between the head, body, and support surface will depend on seating factors (geometry, compliance), body and head restraint systems, individual seat occupant stature, mass distribution, and body component shape, as well as body segment compliance. As noted above, body segment compliance will change with G-bias loading during dynamic phases of flight, including launch and entry. Body segment compliance can also change with voluntary muscle activation due to task performance demands as well as with involuntary muscle activation triggered by the vibration itself.

The impact on visual performance of multi-axis head vibration, multi-axis target (i.e., display) vibration, or the two in combination is difficult to evaluate *a priori* because variations in phasing or frequency components may produce image blur or motion patterns that are too complicated to compare against previously reported single-axis vibration data. In particular, while the input motion may be well controlled in a reported study, the actual motion pattern of the individual observer's head and eyes may not be known. In some cases, head and/or target motion may produce horizontal and vertical image motion at the same single frequency. The consequent Lissajou-like elliptical motion patterns may be readable if they are slow enough for pursuit eye tracking or if their combined amplitude is small enough to remain below blur thresholds. Combinations of multiple frequency components within or across multiple body, head, or display axes may produce resultant image motion patterns that are too complex to track, even if individual frequency or directional components may be slow enough to track visually. It has been observed in one study (Moseley et al., 1982) that degradation in visual performance is greater for sinusoidal whole-body vibration as opposed to more broadly tuned (one-third octave) random vibration of comparable RMS magnitude.

Griffin (1990, Section 4.2) and Boff and Lincoln (1988) provide comprehensive summaries of research findings pertaining to the above mentioned and other features visual performance under vibration.

6.7.3.3 Manual Performance Effects

Manual control is degraded by vibration, causing unintended – or contributing to – imprecise limb movement. Unintended movement can be the consequence of direct biomechanical transmission through the limb originating at the vibrating support point(s). Whole-body vibration or vibration applied locally to specific muscles and muscle groups can alter spinal reflex properties (e.g., Martin et al., 1984) or modify the perception of limb motion or position (e.g., Craske, 1977), thus impacting manual control accuracy.

Low-frequency oscillation of the torso can affect activities involving unsupported arm movements including manual reaching to control panels. Vibration transmitted to a hand control interface may further degrade system performance if the system responds at the frequency of the vibration.

Manual tasks can be usefully classified into three types, each being differentially susceptible to vibration in interacting the arm and hand (McLeod & Griffin, 1986, as cited by Seagull & Wickens, 2006, p.10). Type A tasks involve continuous manipulation of the hand without support, such as reaching and pointing. Type B tasks involve continuous manipulation of spatially anchored objects such as joysticks, steering wheels, or dials. Type C tasks encompass discrete interactions with spatially anchored objects such as button pressing or switch toggling. The general findings were that vibration affects Type A task performance most, on Type B tasks somewhat, and on Type C tasks not very much. For Type A and Type B tasks, there tends to be a linear relationship between vibration magnitude and the disruption of task performance.

Performance on Type B tasks depends on the alignment of required object motion with respect to vibration direction. Disruption is greater when the direction of object motion (e.g., joystick deflection) coincides with vibration direction and is lower when motion is orthogonal to the vibration.

6.7.3.4 Vibration Exposure Performance Limits

6.7.3.4.1 Gemini Program

Specific concerns for 11-Hz POGO of the Titan-II rocket triggered a series of centrifuge and ground-based studies in 1963 to support definition of crew-vibration requirements for the Gemini program. Astronauts evaluated the degradation of coarse- (c) and fine- (f) scale visual (V) and manual (M) performance during a part-task simulation as function of 11-Hz *x*-axis vibration amplitude superimposed on a 3.8-G_x load corresponding to launch. (Vykukal & Dolkas, 1966) The astronauts' summary ratings on a 1 to-10 scale, shown in Figure 6.7-6, indicated self-reported performance decrements beginning at 0.3 g (0-peak), which led to specification of the Gemini crew vibration limit of 0.25 g.

Activity-Precision	ACTIVITY (N = 7 astronauts) *CORRESPONDING DISPLAYS AND CONTROLS NOT INCLUDED IN SIMULATION, ESTIMATED EFFECT OF VIBRATION	PILOT RATINGS AT VARIOUS VIBRATORY LEVELS (g _{0-peak})				
		0.14	0.30	0.53	1.36	1.65
V-f	1. ABILITY TO READ RATE NEEDLES (±2° per sec)	2	4	6	8	9
V-f	2. ABILITY TO READ DIGITAL TIMER	2	5	6	9	10
V-f	3. ABILITY TO READ ACCELEROMETER	2	4	5	8	9
M-c	4. ABILITY TO ACTIVATE BOOSTER SHUTDOWN	1	2	3	4	6
M-c	5. ABILITY TO ACTIVATE SECONDARY GUIDANCE	1	2	3	4	6
S-	6. ABILITY TO SPEAK	1	3	4	7	9
V-c	7. ABILITY TO SEE ABORT, OVERRATE, AND GUIDANCE LIGHTS	1	2	3	4	5
*M-f	*8. ABILITY TO ACTUATE TOGGLE AND CURRENT BREAKER SWITCHES	3	4	6	8	9
*V-f	*9. ABILITY TO READ CABIN, ECS, FUEL CELL AND PROPELLANT PRESSURE	2	4	5	8	9
*M-f	*10. ABILITY TO ADJUST SUIT FLOW CONTROLS	2	3	5	8	9
*V-f	*11. ABILITY TO READ LAUNCH ATTITUDE ERROR	2	4	6	8	9
*V-f	*12. MASKING OF OTHER CRITICAL VIBRATION AND BOOSTER MOTION CUES	3	4	7	9	10
OVERALL MEDIAN RATING		2	4	5	8	9

DEGRADATION: NONE, SLIGHT MODERATE SEVERE

Figure 6.7-6 Astronaut ratings of performance degradation as a function of 11-Hz vibration amplitude superimposed on 3.8-Gx bias. [Adapted from (Vyukal & Dolkas, 1966)]

Data plotted in Figure 6.7-7 from studies conducted on the same centrifuge show objectively measured error rates were significant for fine-scale dial-gauge reading beginning at 0.4 g (the lowest non-zero vibration level tested) for 11-Hz vibration (excluding harmonic distortions). (Clarke et al., 1965; Vyukal & Dolkas, 1966) Figure 6.7-7 also demonstrates that coarse-scale dials, for which the task was largely a dial-direction judgment as opposed to gauge reading, were generally resistant to reading errors.

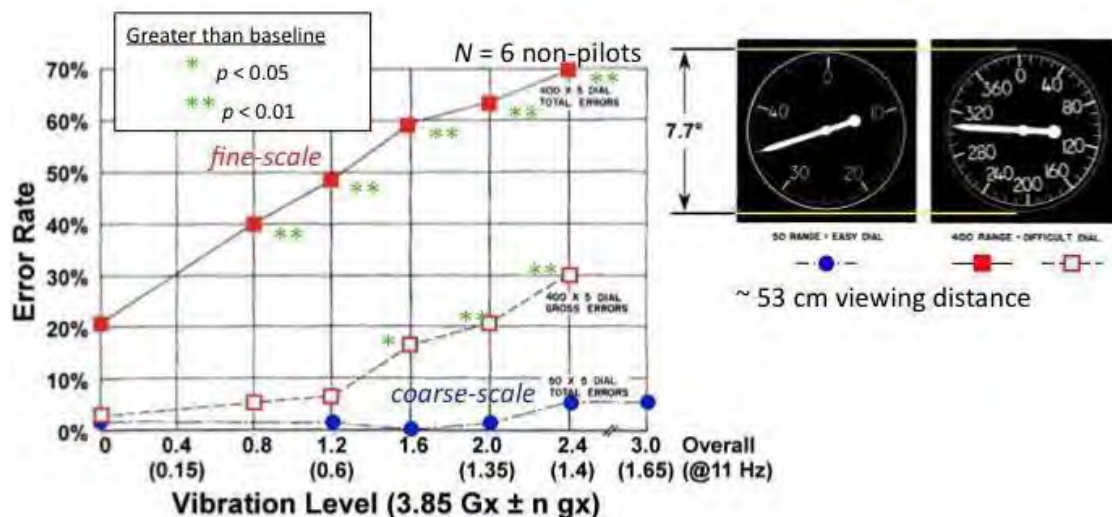
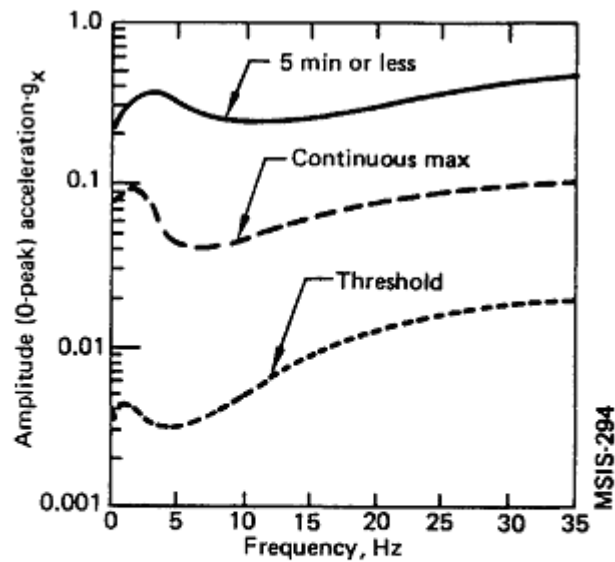


Figure 6.7-7 Fine- and coarse-scale dial reading error rates by general-population observers as a function of vibration amplitude (11-Hz fundamental and overall signal with harmonic distortion) superimposed on 3.8-Gx bias. [Adapted from (Clarke et al., 1965)]

6.7.3.4.2 Apollo Program

NASA standards (Wheelwright, 1981) for Apollo limited x-axis vibration to the levels shown in Figures 6.7-8 (0-35 Hz) and 3.4.2.2 (35-1000 Hz) for crewmembers during launch for visual monitoring of critical displays, and for visual activity and toggle switch manipulation, respectively.



Reference: 198, page 13

Figure 5.5.3.3.2-1 Tolerance Limits to Equivalent Sinusoidal Vibration (g_x) for Visual Monitoring of Critical Displays During Launch

Figure 6.7-8 Tolerance limits to equivalent sinusoidal vibration (g_x) for visual monitoring of critical displays during launch.

!

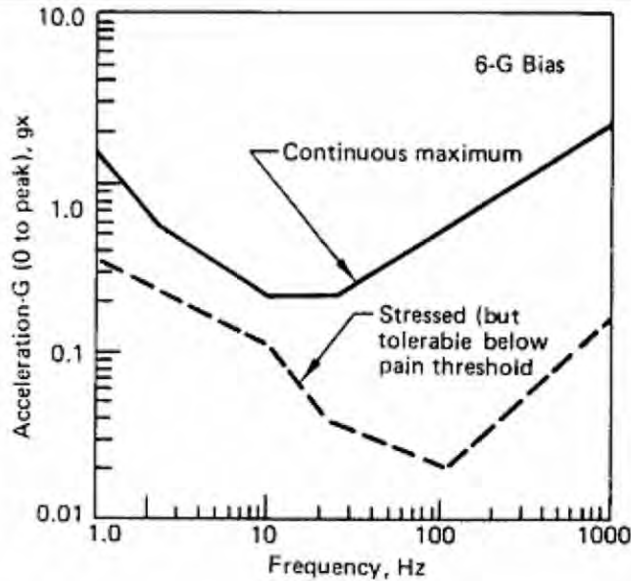


Figure 6.7-9 Maximum tolerable limits of vibration (g_x) for visual activity and toggle switch manipulation during launch.

6.7.3.4.3 Constellation Program

Concern for narrowly tuned vibration arose again during the 2005-2010 Constellation Program because of potentially severe Ares-I rocket thrust oscillation. Whereas the Ares-I thrust oscillation frequency, centered at 12 Hz, was similar to that of the 1960's POGO studies, the Gemini-heritage “steam-gauge,” incandescent lamp, and scroll-wheel interfaces were supplanted by modern, digitally-driven, flat-panel screens displaying both text and graphical content.

To assess the usability of modern display technologies under vibration, a series of studies involving both astronaut and age-matched general-population observers were conducted on vibration platforms in the laboratory (1- G_x bias) and on the centrifuge (3.8- G_x bias). Error rate and response time data in Figure 6.7-10, collected for a number reading and processing task for vibration superimposed on a 3.8- G_x bias, indicated that observers begin to experience degradation in display usability for 12-Hz vibration above 0.3 g_x (unweighted, zero-to-peak) when viewing cluttered, high-density text formats presented on modern flat panel displays. (Adelstein et al., 2009b) The same frequency vibration at 0.7 g_x produced statistically significant (indicated by asterisks) increases in error rates and reaction times for 10- and 14-pt text viewed at arm's length (~50 cm). Also, immediately following cessation of the continuous 145-s exposure, performance returned to levels indistinguishable from the zero-vibration baseline. This implies the absence of a significant aftereffect following vibration for the specific reading task and experiment conditions.

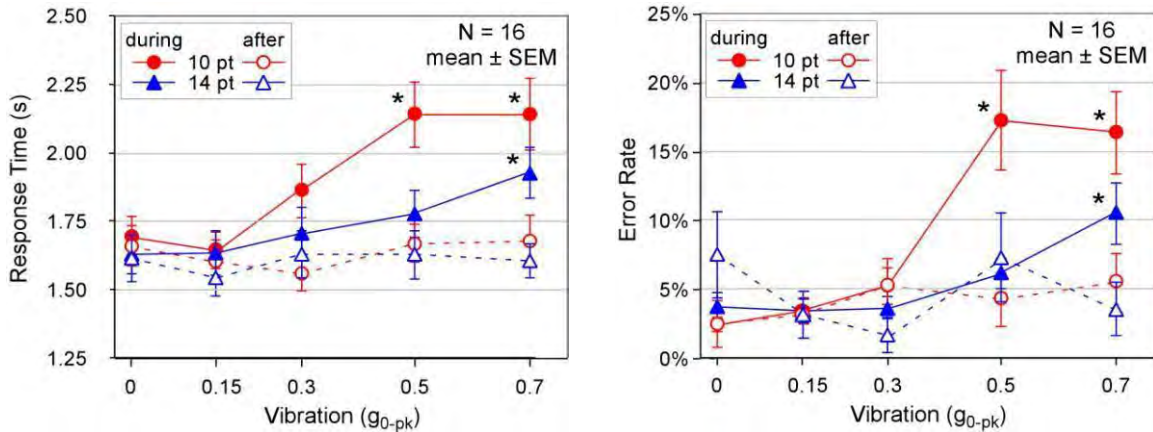


Figure 6.7-10 Mean response times (left) and error rates (right) for the general-population participants during (solid symbols and lines) and immediately after (open symbols and dashed lines) vibration at each of the five levels.

Astronaut participants made assessments of the subjective visual degradation in display usability for both 10- and 14-pt text sizes under both 1- and 3.8- G_x bias as vibration amplitude was steadily ramped up and then back down for a 10-Hz complex signal that was convertible empirically to its 12-Hz equivalent. (Adelstein et al., 2012, in preparation). Rather than call out specific ratings (cf. Vykukal and Dolkas, 1966), participants marked the vibration level at which they judged the degradation of the display to transition from slight (green) to moderate (yellow) to severe (red) and back. Figure 6.7-11 superimposes the astronauts' objectively measured error rates (mean \pm SEM) for 12-Hz vibration over the boundaries (mean \pm SEM) in their usability ratings, indicating that, on average, they noted only slight degradation for 0.3- g_x vibration. Usability degradation, for the 10-pt text was judged severe at 0.5 g_x and for both text sizes at 0.7 g_x .

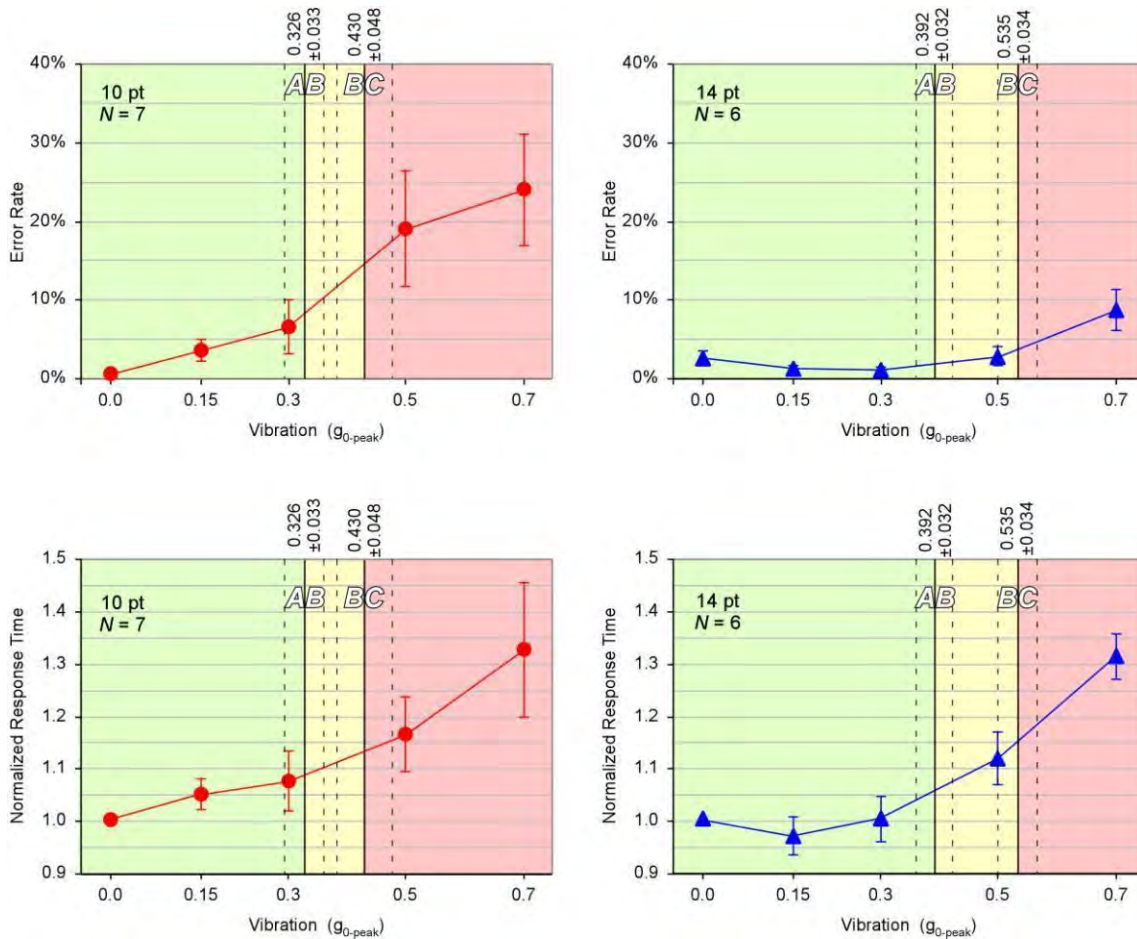


Figure 6.7-11 Objectively measured error rates (top row) and response times (bottom row) for astronaut participants are shown separately for 10- (left column) and 14-pt (right column) displays superimposed over subjective display usability judgment boundaries.

Because the continuous 145-s constant-amplitude, 12-Hz vibration was not considered to be representative of an actual Ares-I thrust oscillation event, a flight-representative fault-detection task arising during a 10-s time-varying vibration burst was examined in a 1- G_x laboratory experiment. While the astronauts in the study maintained low task error rates as the vibration's average and peak amplitude were increased, they did so at the expense of statistically significant increases in response time and workload. The stacked bar chart in Figure 6.7-12 shows the shift in Bedford-scale workload ratings (Roscoe, 1984) and the increase in the median rating as the magnitude of the vibration, denoted in terms of the peak and RMS, increases across the five study levels.

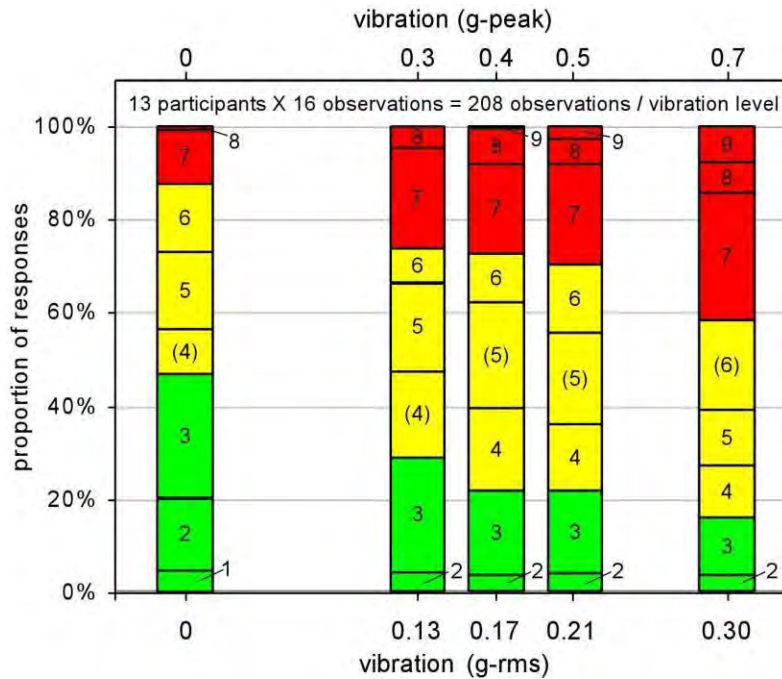


Figure 6.7-12 Proportion of Bedford rating responses in each ordinal category (1-9). Colors indicate primary Bedford workload categories (green: satisfactory; yellow: tolerable but not satisfactory; red: not tolerable). Numbers in parentheses indicate median rating across participants for that vibration level.

As a result of these studies, the Constellation program set crew performance limits of 0.21 g_x RMS for a 5-s averaging window (equivalent to 0.3 g_x zero-peak for a constant amplitude sinusoid) and an instantaneous peak value of 0.7 g_x for 10-13 Hz crew vibration resulting from Ares-I thrust oscillation. While these modern empirically derived limits are very similar to the 11-Hz specification set for the Gemini program, it should be noted that both the historical and modern findings apply only to a very restricted frequency band for single-axis chest-to-spine (body x -axis) vibration and specific G-bias levels. Moreover, the recent supporting data were collected in studies where the display hardware did not vibrate. Real space launches deliver time-varying complex and random vibration that will shake occupants and interface hardware in multiple directions concurrently while the underlying G-load changes during flight.

6.7.4 Vibration Design Considerations

6.7.4.1 Human Responses to Vibration Plus G Loading

There has been limited research combining vibration with other environmental stressors such as acceleration, noise, and altitude. At 3.5 G, vibration levels above 0.3 g_x at 11 and 12 Hz can affect crewmember performance. (Vykukal & Dolkas, 1966; Clarke et al., 1965) Elevated G-bias apparently can change some body vibration resonances as well as lower tolerance limits. At 1-G, the abdominal mass resonates at 4-8 Hz. The resonant frequencies of body structures and internal organs increase with G-bias because their stiffness grows due to compression under G loading. For example, at 2.5 G, awareness of stomach vibrating becomes more pronounced for vibration between 9.5 and 12.5 Hz. (Vykukal, 1968) Additional studies are needed to determine the effects of increasing vibration magnitude on impedance for higher G-bias levels experienced during launch.

A summary of interactions between vibration and various other environmental factors (Murray & McCally, 1973) is provided in Table 6.7-6.

Table 6.7-6 Combined Stress – Vibration and Other Environmental Factors

Stresses	Test Animal	Measures	Effect	Physiological Interaction
Vibration + acceleration	Man	Whole body mechanical impedance	Vibration (+0.4g at 2.5-20 Hz) combined with linear acceleration (1, 2 1/2, and 4G) produces increased stiffness, reduces damping, and increases energy transmission to internal organs	Additive
Vibration + acceleration	Man	Compensatory tracking task	Vibration (0 - 3.0g at 11 Hz) combined with linear acceleration (1 - 3.5G) produces performance decrements not significantly different from vibration alone	None
Vibration + heat	Rats	Mortality	Incidence of mortality (62%) is greater after 20 min exposure to heat (46.1 deg C) and random vibration (5-800 Hz 17.5g RMS) in combination rather than individually	Additive
Vibration + hypoxia	Rats	Mortality	Mortality of restrained rats increases directly with hypoxia (altitude 8-18,000 ft) during +G _x vibration (60 Hz 15 g peak acceleration)	Additive
Vibration + pressure breathing	Mouse	Mortality, tissue change	Pressure breathing (4 in. H ₂ O) reduces mortality of mice exposed to 10 min of 20 Hz random vibration (7.0g RMS)	Antagonistic
Vibration + acceleration	Man	Visual performance	(+3.85G _x) acceleration improves the visual performance decrement associated with (11 Hz, g _x) vibration	Antagonistic
Vibration + carbon dioxide	Man	Ventilation	+g _z vibration (40 Hz) and increased inspired CO ₂ both increase ventilation but are not additive in combination	None
Vibration + noise	Man	Physiological measures, performance	+G _z vibration (semirandom) (0.16-0.4 g RMS) and noise (~112dB) have no significant effect on multiple performance measures or physiological responses in simulated helicopter flight	None
Vibration + noise + temperature	Primate, man	Sleep-stage EEG, performance	+G _z vibration (0.7g RMS), noise (102 dB), and heat (90 deg F) in combination produce significant sleep disturbance and performance decrement (shock avoidance)	Additive
Vibration + noise	Man	Performance (compensatory tracking and reaction time)	Noise (100 dB) and vibration (0.25 g _z , 5 Hz) produce additive decrement in vertical component of compensatory tracking task	Additive
Vibration + drugs	Mice	Mortality, tissue damage	Mortality is decreased significantly by CNS depressant and increased by CNS stimulants	Not examined

6.7.4.2 Vibration Design Guidelines

The vibratory environment of the space vehicle must be designed to protect the crewmembers and preserve their ability to perform their operational functions with proficiency throughout the total mission.

Basic environmental limitations and criteria that apply to the design of crew stations and other habitable compartment areas within space module are discussed below. Included are various environmental vibration parameters essential to crew safety and comfort during a complete mission.

6.7.4.2.1 General Vibration Design Guidelines

The following general vibration design criteria must be observed:

a. General Vibration Design: Vibration generation and penetration must be controlled to the extent that vibration energy will not cause injury to personnel, interfere with task performance, induce fatigue, or contribute to the degradation of overall human-system effectiveness during crew-operated periods. With regard to injury and health risk, vibration must be controlled in terms of exposure magnitude and duration.

It should be noted that, in many cases, modification of tasks and equipment can mitigate vibration-induced decrements in task performance, fatigue, and overall efficacy.

b. Equipment Vibration

- 1.** All on-board equipment that may be sources of vibration must be mounted and located to reduce vibration at crew stations.
- 2.** System design must include vibration control provisions.
- 3.** Means must be provided to facilitate periodic measurement of vibration levels to verify that exposure limits are not being exceeded.

c. Crew interfaces and procedures must be designed to accommodate anticipated vibration levels without interfering with critical task performance.

In addition to these general criteria, MIL-STD-1472G (2012) also establishes a number of specific design requirements for the development and deployment of user interfaces in vibration environments. It bars touch-screen, eye-, and head-based input devices; mandates the placement of hand and arm supports near controls, including the mounting of thumbtip- and fingertip-operated joysticks on handgrips, which can serve as a steady rest to attenuate vibration and improve precision; and recommends that audio displays be made available when vision would be degraded by vibration.

6.7.4.2.2 Example Vibration Design Solutions

The control of vibration involves three interdependent elements: 1) Vibration control at the source, 2) interruption or absorption along the transmission path, and 3) protection at the receiver. In many situations where vibration cannot be eliminated or is too difficult or costly to control, other compensation techniques should be considered to make equipment more usable or crew tasks easier to perform.

Vibration control techniques that can be applied to the space module may be basically the same as used in industrial and building vibration control. The G-bias in the various phase of spaceflight, however, will affect the vibration characteristics of space vehicle system components.

6.7.4.2.3 Vibration Countermeasures

6.7.4.2.3.1 Vibration Control at the Source

The design of the space vehicle/equipment and control of vibration is initially implemented by stating equipment procurement specifications and locating equipment remotely from crewmember workstations and rest/sleep areas. The sources of vibration are:

- a. Torsional
- b. Bending
- c. Flex and plate-modes
- d. Translational, axial, or rigid-body
- e. Intermittent
- f. Random and miscellaneous

Figure 6.7-13 lists examples of sources of vibration. (Peterson, 1980, p. 11) Methods of controlling vibration of various sources are listed in Figure 6.7-14. (Peterson, 1980, pp. 241, 247-249)

<u>Torsional vibration</u>	<u>Translational, axial, or rigid-body vibration</u>
Reciprocating devices	Reciprocating devices
Valves	Engines
Compressors	Compressors
Pumps	Shakers
Engines	Motors
Rotating devices	Devices on vibration mounts
Electric motors	
Fans	
Turbines	<u>Intermittent vibration</u>
Gears	Impacts on floor
Turntables	Impacts on walls
	Impacts on the hull
<u>Bending vibration</u>	Typewriters
	Stepping motors
Shafts in motors	Relays
Springs	
Belts	
Pipes	
<u>Flexural and plate-mode vibration</u>	<u>Random and misc. vibration</u>
Hulls and decks	Rocket combustion
Turbine blades	Aerodynamic turbulence
Gears	Gas and fluid flow
Floors	interacting in pipes
Walls	and ducts

Figure 6.7-13 Sources of vibration.

<p><u>Gas or fluid flow vibrations</u></p> <ul style="list-style-type: none"> Reduce flow rate Use less pressure Use quieter valve Modify impeller Smooth pipe or duct Lagging of pipe or duct Use flow turning vanes at bends 	<p><u>Magnetic vibration</u></p> <ul style="list-style-type: none"> Use quieter motor, choke or transformer Isolate or enclose Relocate
<p><u>Gear vibrations</u></p> <ul style="list-style-type: none"> Use proper lubrication Reduce speed Balance gear Replace worn/damaged gears Use higher quality gear Use different material gear 	<p><u>Belt/chain vibration</u></p> <ul style="list-style-type: none"> Adjust tension Adjust alignment Lubricate properly Reduce speed Change material or type
<p><u>Rotor vibrations</u></p> <ul style="list-style-type: none"> Balance rotor/coupling Modify force or speed Alter rotor bearings Add damping Reduce mass of moving elements 	<p><u>Pump noise</u></p> <ul style="list-style-type: none"> Reduce speed Reduce pressure Alter pressure cycle Isolate
<p><u>Bearing vibrations</u></p> <ul style="list-style-type: none"> Lubricate properly Adjust bearing alignment or mounting Reduce speed Replace worn or damaged bearings Different bearing type 	<p><u>Combustion noise</u></p> <ul style="list-style-type: none"> Correctly adjust burner Use lower pressure barrier
	<p><u>Impact vibration</u></p> <ul style="list-style-type: none"> Avoid it Cushion it Apply damping

Figure 6.7-14 Vibration control methods at the source.

Example vibration problem: Intense vibration at 11 Hz was experienced with the Titan II rocket engine. A similar problem was detected in an early Saturn V test. Fuel pump and engine phasing modifications reduced the vibration intensity to acceptable levels.

6.7.4.2.3.2 Control of Vibration – Path Transmission

Space module structure vibration can be excited mechanically or by airborne (aero-acoustic) noise. Increasing the losses in the vibration transmission path is a common way to reduce vibration levels at the receiver.

Excitation of structures such as walls, floors, and ceilings can be reduced by noise control at the acoustic source or by applying acoustic absorption and damping material at the excited structure.

Mechanically coupled transmission can be controlled by interrupting the transmission path to the receiver or by introducing attenuating element couplings between the source and the receiver. Figure 6.7-15 lists common ways to reduce vibration path efficiency. (Peterson, 1980, p. 242)

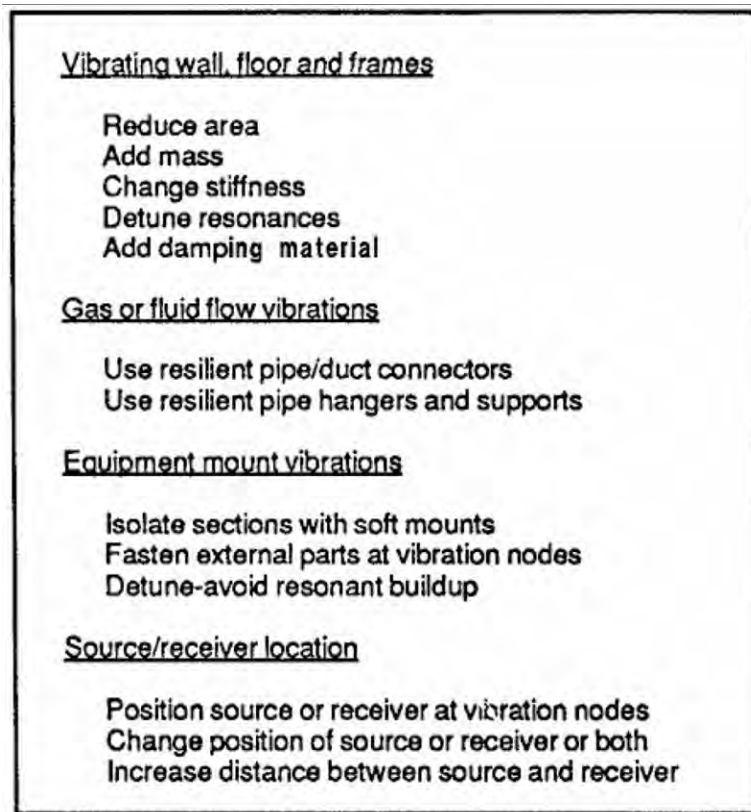


Figure 6.7-15 Control of path vibration.

6.7.4.2.3.3 Vibration Protection

Protection of crewmembers from vibration problems is best served by controlling vibration at the source or along the transmission path. Residual over-limit vibration at crew stations requires special attention to body posture and support.

a. Body Posture – The semi-supine position is generally considered best for severe vibration in *x*-, *y*-, or *z*-axis, especially under high *G*-bias loads, i.e., launch, reentry, etc. The seated position is worse for *z*-axis vibration. The standing position is worse for *x*, *y*-axis vibration.

b. Crewmember Supports – The resonant frequency of crewmember supporting surfaces should be one-half of the lowest vibration frequency of significance. Supports that can offer vibration protection are:

- Contoured seats
- Contoured and adjustable couches
- Elastic seat cushions
- Suspension seats

- Body restraints
- Rigid or semi-rigid body enclosures
- Head restraints
- Vibration absorbent hand/foot pads

Note that compliant and elastic supports to mitigate vibration may run counter to the guidelines for occupant protection against the high transient accelerations (i.e., mechanical shock) associated with hard landing or launch abort systems. In some cases, compliances inserted to protect against mechanical shock may introduce resonances that can aggravate vibration response (cf. MIL-STD-1472G, 2012, p.160).

Positioning crewmember stations on structure nodal points can alleviate demands on crewmember body support systems.

In the case of visual displays, vibration effects may be mitigated through better information design. For example, during periods of high vibration, graphical or pictorial information displays may be more robust than text displays under vibration. (Adelstein et al., NASA TM in preparation) If text displays must be used, font, font sizes, colors, and display panel brightness and contrast could be adjusted to improve readability. Also, strobed illumination of information on display panels in synchrony with the whole-body vibration experienced by the observer has been demonstrated to be a useful countermeasure, potentially restoring display readability to non-vibrating baseline levels. (Adelstein et al., 2012)

6.7.4.3 Vibration Requirement Development and Verification

The development of vibration requirements for crew health and performance during spaceflight, as well as methods for requirement verification, can draw initially from prior data and existing standards founded on those data, as discussed elsewhere in Section 6.7. However, since the data underlying such standards have been collected in Earth environments, extension to the rigors of spaceflight must proceed with caution because there will always be an interaction between vibration and other environmental and physiological factors, such as (but not necessarily limited to) those listed in Table 6.7-6.

For example, in conjunction with vibration, astronauts can simultaneously encounter hyper- (or hypo-) gravity and varying lighting conditions. Furthermore, they may be required to perform tasks with demands that are unique to the spaceflight environment while deconditioned from prolonged missions, and restrained by safety systems and bulky spacesuits. Because all of these factors may impact performance, and because of potential interactions between these factors, an accurate determination of acceptable vibration levels cannot be conducted in isolation. Therefore, for the development of generalizable knowledge (i.e., a design trade space) or for the assessment of individual design configurations, empirical evaluations should consider more than just the vibration and include as many other contributing factors as possible. For example, the studies outlined in Section 6.7.3.4, which led to the establishment of Gemini and Constellation Program vibration requirements, took into consideration crew ability to perform select representative tasks in simplified environments.

Execution of such assessments, whether for the development of requirements, the validation of analyses, or for verification by other means, necessitates participation by multiple organizations and disciplines. These organizations and disciplines should not only work together to determine the pertinent studies and the critical study components, they need also be involved in the design and conduct of the studies as well as the analysis and interpretation of the resulting data. Finally, the stakeholders together must evaluate and weigh the potential programmatic impacts of the study findings.

For example, to establish the thrust oscillation vibration limit for the Constellation Program (Section 6.7.3.4.3), studies incorporated contributions from the following disciplines:

- Propulsion and structural engineers for the vibration loads

- Structural engineers for seating prototypes

- Interface, display, and guidance, navigation and control engineers for developing representative tasks

- Astronauts for spaceflight-relevant experience

- Human factors scientists, including human vibration subject matter experts, for experimental design, conduct of the studies, and analysis of the resulting data

Together, the contributors and stakeholders (including the various engineering elements, human factors scientists, Astronaut Office representatives, and program management) negotiated and agreed on the facets of the expected flight environment that would be represented in the studies. Just as was the case for the Gemini program (Section 6.7.3.4.1), the Constellation Program studies that specifically required astronaut skills and task expertise involved astronauts as study participants. (Other studies not requiring spaceflight expertise – e.g., text readability under vibration – used participants from the general population who were age-matched and consequently had visual capabilities comparable to the astronauts.) Based on the objectively measured performance data and on crewmember experience garnered from the series of studies, the Astronaut Office, in collaboration with human factors vibration subject matter experts, proposed a “not-to-exceed” requirement for the thrust oscillation vibration magnitude at the crew seat that was adopted by the Constellation Program.

6.7.5 Research Needs

1. Empirical and theoretical understanding of how vibration causes visual performance degradation.

Specific attention needs to be focused on the role of the translational and rotational vestibulo-ocular apparatus in conjunction with biodynamic response of the eye and head-neck systems for gaze stabilization under vibration and under vibration coupled with the elevated G-loading associated with spaceflight. The full trade space of vibration direction, frequency, and amplitude and span of G-loading will need to be assessed with sufficient range and granularity, especially given the severely nonlinear nature of the interaction.

2. Empirical and theoretical understanding of how manual performance is impacted by combined vibration and G-loading.

Differences between visually-guided and visual open-loop manual control including free motion (isotonic) and constrained force application (isometric) need to be examined fully. Consideration should be given to arm, hand, and finger (and foot) activity, all of which are relevant to the design and successful use of input devices in environments that combine vibration and G-loading. The full trade space of vibration direction, frequency, and amplitude, as well as span of G-loading will need to be assessed with sufficient range and granularity.

3. Empirically derived understanding of how existing vibration tolerance and comfort standards are changed by different levels of G-loading across the full span of ISO-weighting frequencies, in all body axes and for different exposure durations.

Subjective (survey responses) and objective (e.g., stress hormone levels, autonomic nervous system responses) data are currently lacking and are needed for the establishment of human limits specific to spaceflight, rather than for occupational and transport environments on Earth. Empirically founded, spaceflight specific limits will help guide the design of seating and restraint systems, space suits, manual input devices, and crew tasks. Work in this area may also serve to elucidate the types of injury, physiological stress responses, and other health concerns that arise from short-duration exposure to high amplitude vibration – a topic that has received limited attention in the literature. (Most of the literature focuses on chronic exposure to lower levels of occupational exposure.) Animal research on vestibular system impacts is needed, using recoverable and non-recoverable insults.

4. Assessment of cognitive impacts potentially triggered by large-amplitude vibration bursts associated with spaceflight.

The historical studies (Magid et al., 1960; Temple et al., 1964) underpinning current tolerance limits note psychological impacts such as transient confusion, disorientation, and anxiety during severe vibration. Such factors could impair judgment and be problematic for crew-in-the-loop decision-making during critical phases (e.g., abort).

5. As part of the empirical research studies outlined above (topics 1 through 4), data need to be collected to enable the impacts of both single-frequency and single-direction (e.g., body x -, y -, and z -axis) vibration to be compared with multi-frequency and multi-direction vibration.

Existing standards treat the impact of concurrent vibration at multiple temporal frequencies and spatial dimensions as additive as the sum (or sum of squares) of individual frequency or spatial components. Because vibration inputs in most real environments, including those of spaceflight, are neither single-frequency sinusoids nor single axis, collection and analysis of such data will enable the validity of existing assumptions on the linear additivity to be assessed.

6. Development of analytic models for human vibration response under a variety of G-loading regimes. These models are needed to predict biodynamic, sensory, and motor responses to vibration.

Sensory impacts should include visual, haptic/tactile, and auditory perception. Motor response should include manual performance and speech production. Upon validation, such models will serve to predict the sensory and motor performance as well as speech intelligibility decrements that may be expected under multi-axis, multi-frequency, time-varying vibration in combination with the G-loading expected for various phases of spaceflight. The resulting models will support analytic tools for the development and deployment of high accuracy numerical simulation, thereby reducing the need for human testing throughout the design cycle. Ultimately, these models will enable requirement verification by analysis rather than by costly testing.

7. Expanded empirical databases of vehicle-operator performance metrics under a variety of vibration and G-loading regimes that span a representative range of nominal and off-nominal multitasking situations, visual and multi-modal information display formats, levels of onboard automation, and forms of crew-ground interaction.

The goal is to tailor general knowledge garnered from research topics 1 through 6 to operational environments, tasks, procedures, and systems that are specific to NASA human spaceflight application.

8. Development of novel crew-focused vibration countermeasures for spaceflight systems.

Countermeasures for the vibration environment should target the design of information displays, manual control interfaces, seating and restraints, space suits and helmets. Successful crew-focused countermeasures could attenuate the mechanical transmission of vibration between crew and their proximal interface equipment and/or minimize the impact of unattenuated vibration on crew performance. A suite of low-power and low-mass crew-focused countermeasures (including interface and ops-concept designs) will expand the

trade-space available for the design and implementation of vibration mitigations for the spaceflight system, potentially obviating the need for costly modifications to launch vehicle propulsion and/or structural components.

6.8 IONIZING RADIATION

6.8.1 Introduction

This section describes the ionizing radiation environment and its sources, its effects on physiology, exposure limits, countermeasures, and monitoring during space flight. Ionizing radiation is defined as any radiation (electromagnetic or particulate) that has the potential to ionize atoms. Examples are high-energy photons, neutrons, and beta particles, as well as plasmas of atomic nuclei. In biological systems, ionizing radiation can cause acute and chronic health effects, depending on the magnitude of the radiation absorbed, the species of ionizing radiation, dose rate, and the tissues affected. Varying individual biological responses and the differing types of ionizing radiation make the task of protecting humans in space flight challenging. As a result future NASA programs must define a standard radiation environment before the design of all human-rated spacecraft.

6.8.2 Space Ionizing Radiation Environment

The ionizing radiation in space is composed of charged particles, uncharged particles, and high-energy photons. The particles of concern vary in size from those of electrons and protons to those of the heavy nuclei, e.g., HZE (high charge and energy) particles. They may have single charges, either positive (protons) or negative (electrons), multiple charges (alpha or HZE particles), or no charge (e.g., neutrons). The nuclear charge and mass determine how quickly these particles lose energy when interacting with matter. For equal energies, an electron will penetrate farther into aluminum than a proton, and an x-ray much farther than either one. In addition, the amount, type, and energy of radiation a spacecraft may encounter varies in different regions of space. These source types and distinct regions (near Earth or in interplanetary space) are examined below.

6.8.2.1 Units

Before a discussion of the sources of radiation present in space and the subsequent effects of radiation exposure on humans is presented, a system of units for comparing levels of radiation exposure needs to be described. The relevant measures are absorbed dose and dose equivalent (H). The absorbed dose is a measure of the amount of energy deposited per unit mass. The SI unit for absorbed dose is the gray (Gy) and it is defined as 1 joule per 1 kg in any desired material. In radiation dosimetry this material is often water, which is used as a tissue substitute. The quantities measured by detectors generally need to be converted to Gy in tissue.

The distribution of energy deposition in tissue can affect the outcome of a biological response. Radiation that deposits large amounts of energy over a short distance will have a greater impact on an organism than radiation that deposits the same energy over a longer distance (over a larger area). The amount of energy deposited per unit length is known as the linear energy transfer (LET) and is in units of keV per micrometer. The dose equivalent, measured in the Sievert (Sv), expresses, for radiation protection purposes, the biological effect of interest for all kinds of radiation on a common scale.

The dose equivalent is obtained by multiplying the absorbed dose by the quality factor (Q), which is used to weight doses in an attempt to account for the energy deposition effect (LET). Calculation of these quality factors is shown in Table 6.8-1.

Table 6.8-1 Weighting (Quality) Factors for Radiation with Different LET

Unrestricted LET, L , in water (keV / μm)	$Q(L)$
< 10	1
10 – 100	$0.32 L - 2.2$
>100	$300 / L^{1/2}$

From NCRP 142, 2000.

To express the potential to damage individual organs, the NCRP 132 (2000)] adopted the use of the Gray equivalent (Gy-Eq). This quantity is analogous to the dose equivalent, as it applies a Q-like effectiveness value to the absorbed dose, but it applies only to deterministic effects in individual organs.

Quality factors based on responses other than cancer are expected to be different from those shown above. Table 6.8-1 reflects changes in older quality factors based on studies of different biological endpoints. It has been shown that radiations depositing between 100 and 200 keV per micrometer have the greatest potential for chromosomal, cellular, and tissue effects. Nevertheless, it is generally accepted that the LET is not a sufficient measure of the damaging potential of all types of radiations. However, information about the response of biological systems, particularly to HZE particles, is currently insufficient to provide a viable alternative to quality factors based on LET. The effectiveness of radiation types in producing a specific outcome (radiobiological effectiveness, RBE), i.e., effects including erythema and vomiting, should be updated as more data is collected. RBE factors have been recommended for use with limits as applied to deterministic effects on critical tissues (NCRP 132, 2000). Some indication of these RBE values based on specific biological endpoints should be included in this handbook as they become available.

6.8.2.2 Sources

The radiation encountered in space may be attributed to four principal sources:

- Solar particles
- Galactic cosmic radiation
- Geo-magnetically trapped radiation
- Radiation-producing devices

The naturally occurring space radiation environment is composed primarily of protons. Their energies and intensities vary according to their source as shown in Figure 6.8-1

(Schimmerling & Curtis, 1978). In terms of potential biological hazard, many types of radiations can be neglected either because the particle is easily absorbed in spacecraft materials or because their flux density (particles·cm⁻²·s⁻¹) is very low. Conversely, some heavy ions, despite their low flux, may be quite effective at depositing energy in human tissues.

Space radiation levels vary substantially with solar activity and distance from the Earth. These temporal and spatial fluctuations should be taken into account in the planning of space missions if radiation exposures are to have minimal impact on biological systems.

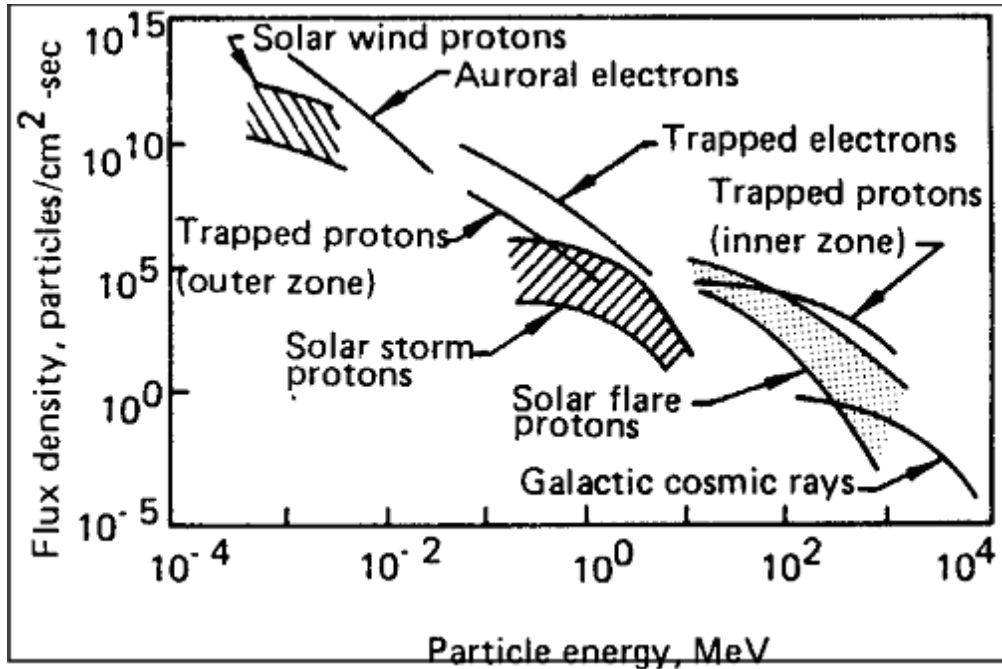


Figure 6.8-1 Energies of various single-charged radiation sources (Schimmerling & Curtis, 1978).

6.8.2.2.1 Solar Radiation

Solar radiation can be divided into two groupings: a steady stream of solar material called the solar wind, and solar particle events (SPEs), which are associated with solar flares and coronal mass ejections. Solar radiation is generally of lower energy and atomic number than galactic cosmic rays or radiation (GCR) (see section 6.8.2.1), and therefore of lower biological concern.

The solar wind is composed of approximately 95% protons, 4% alpha particles, and 1% other nuclei consisting primarily of carbon, nitrogen, oxygen, neon, magnesium, silicon, and iron. These particles contain high (~800 km/s) and low (~400 km/s) speed components. In general the low-speed components contain three times the number of heavier nuclei; however, the speed and composition of the solar wind will change over a roughly 11-year cyclical solar intensity cycle.

Solar flares and coronal mass ejections (CME) are eruptions from the Sun's surface and are usually associated with sunspots. These events are much more likely to occur in the time of solar maximum than at solar minimum activity, although they occur with a much lower frequency than sunspots. SPEs associated with solar flares develop rapidly and can last for days. They produce intense electromagnetic radiations as well as protons, electrons, and plasmas of helium to iron. Although it varies from event to event, the particulate composition is typically 97.8% protons and 2.1% helium. Solar flares are highly unpredictable in occurrence, intensity, and duration. This is due to the magnetohydrodynamic physics processes behind the formation and transport of the particles within the interior of the sun. As a consequence, an intense SPE can arrive at Earth and be complete within hours, or the SPE can last for more than a week, during which there occur bursts of radiation lasting a few hours. The spectra from a large SPE event in 1989 are shown in Figure 6.8-2.

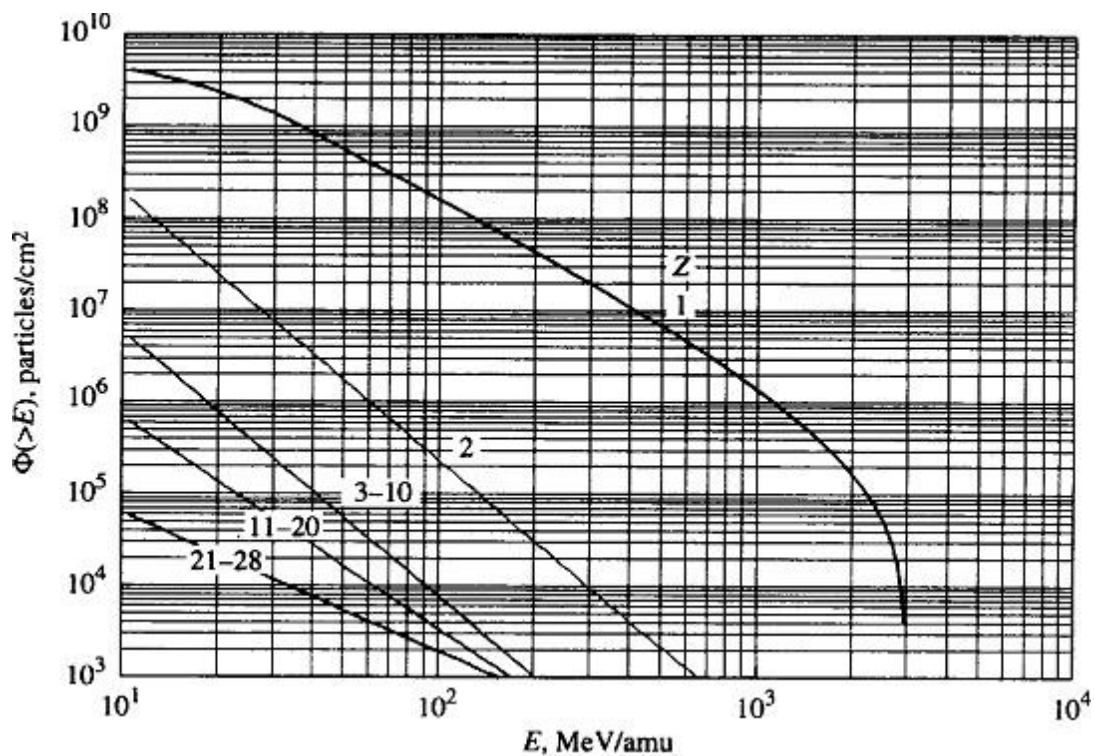


Figure 6.8-2 Event-integrated integral fluence spectra of SPE of September 29, 1989 (Kim et al., 1999).

As shown in the figure, a large number of the particles from an SPE are protons at energies (< 10 MeV/nucleon) that spacecraft hulls can relatively easily shield space travelers from. This plot illustrates the rapid falloff in intensity with increasing energies common to all CMEs. The very high density of protons with energies greater than 10 MeV can still be a particular source of concern for EVA, while protons of more than 30 MeV can be of concern to thinly shielded spacecraft. Figure 6.8-3 (from <http://physics.nist.gov/PhysRefData/Star/Text/programs.html>) shows a plot of the projected range in aluminum of protons of various energies.

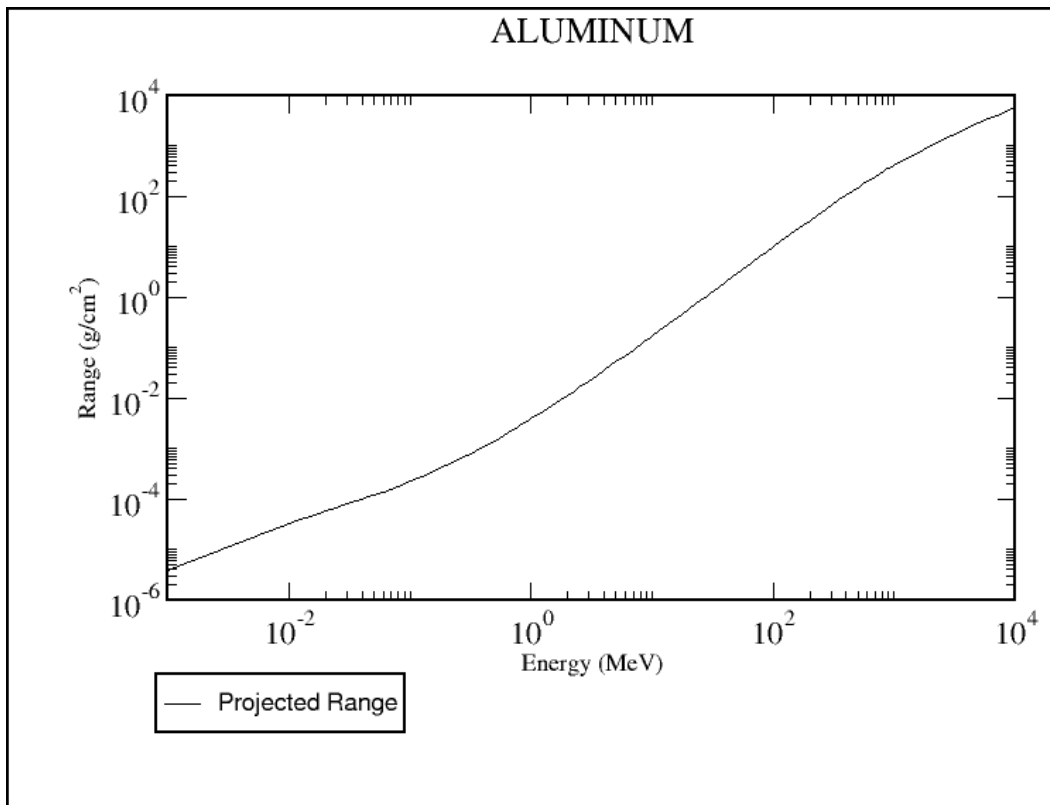


Figure 6.8-3 Projected range in aluminum of protons of various energies.

Solar activity follows roughly an 11-year cycle. These cycles are characterized by alternating periods of increased and decreased numbers of observable sunspots. The number of sunspots will vary from month to month. If the number of individual sunspots is smoothed, plots similar to that of Figure 6.8-4 are obtained.

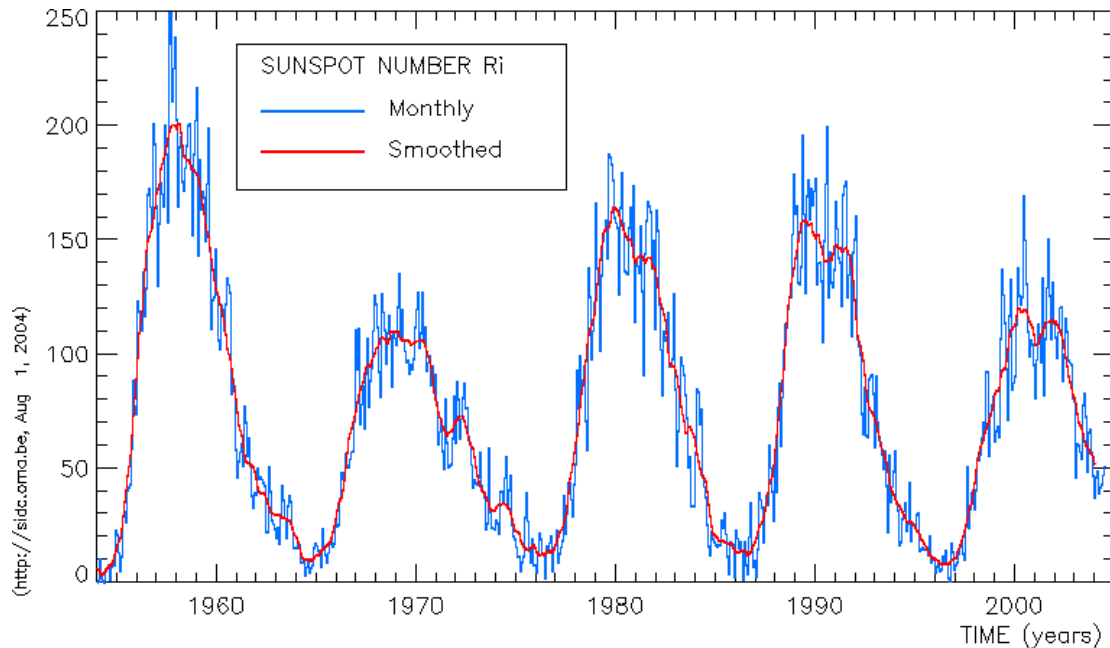


Figure 6.8-4 Approximate 11-year solar cycle (<http://sidc.oma.be/index.php>).

Accurate prediction of the time and intensity of individual SPEs is not currently possible; however, the more general prediction of the smoothed intensity of an entire solar cycle can be reliably predicted (Hathaway et al., 1994). These predictions are possible because relationships have been found between the size of the next cycle maximum and the length of the previous cycle, the number of sunspots at solar minimum, the magnitude of the previous solar maximum, and changes in the Earth's magnetic field at and before solar minimum. Although these relationships will not reveal the intensity, probability of occurrence, or exact timing of an individual solar flare, they can be used to estimate the probability of occurrence and number of SPEs that a long-term space flight will likely encounter (Kim et al., 2006). Example predictions of smoothed solar events over the next solar maximum (cycle 24) are shown in Figure 6.8-5. (Ref. Note that the figure shows two models for the next cycle.)

Solar Cycle 24 Sunspot Number Prediction Data Through 31 Mar 07

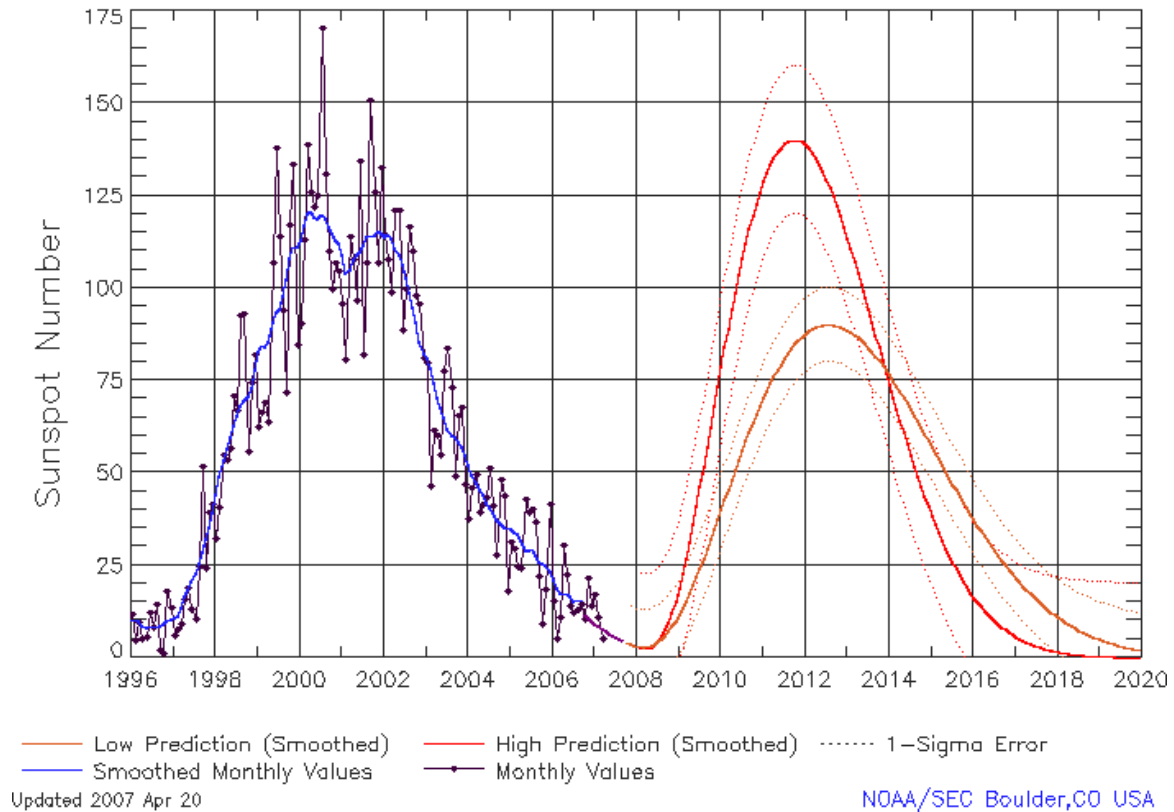


Figure 6.8-5 Predictions of the number of sunspots in Solar Cycle 24.

Modern data on SPEs has been collected only since 1956, which corresponds to the beginning of cycle 19. This data indicates that about 30 to 50 major SPE events occur per cycle, most during the middle 5 years corresponding to solar maximum. Of particular note are the occasional very large CMEs, which have the potential for effects on crew health. One such SPE, commonly known as the August 1972 event, is among the largest recorded events. Although this event is often used in planning for protection from radiation from possible future SPEs, it may not be the worst-case scenario. Examination of nitrates in ice core samples has indicated that solar events of up to ten times the intensity of the 1972 event have occurred in the past 500 years (Shea & Smart, 2004). The doses to skin, eyes, and blood-forming organs (BFO) from such an event are shown in Figure 6.8-6 (Townsend, 2006).

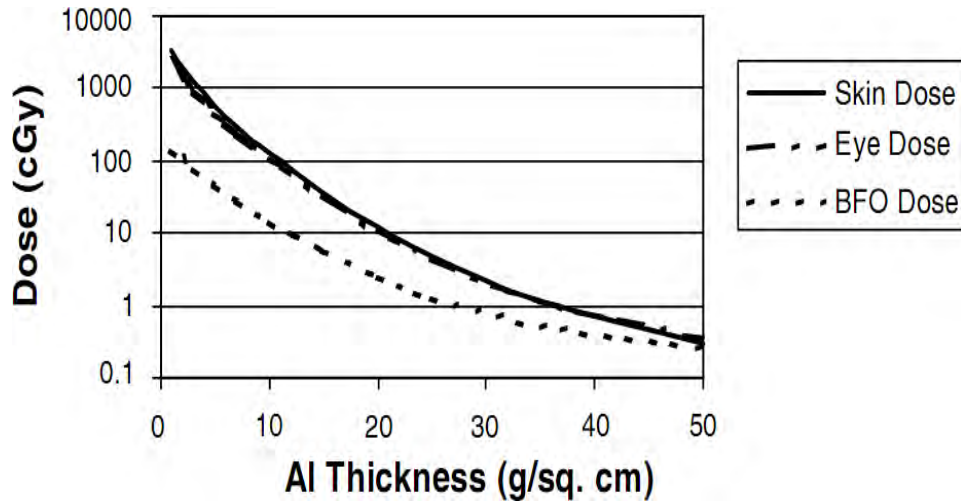


Figure 6.8-6 Organ doses versus aluminum shield thickness in deep space for 1859 event, based on the August 1972 spectrum.

6.8.2.2.2 Galactic Cosmic Radiation

GCR originates outside our solar system, and although the Sun has a moderating effect, GCR is treated as an isotropic radiation source. This radiation consists of atomic nuclei of hydrogen to uranium that have been ionized and accelerated to very high speeds (i.e., energies). Protons (hydrogen nuclei) constitute about 87% of this radiation, alpha particles (helium nuclei) about 12%, and heavier nuclei (particles from $Z = 3$ to approximately 30) the remaining percent (Simpson et al., 1983). Nuclei with an atomic number (Z) greater than 30 are also present, but at extremely low levels (their combined abundance is only about 10^{-4} of that of iron). Electrons and positrons constitute about 1% of the overall GCR but are a minor biological hazard compared to the bulk of GCR, since they are easily shielded. Conversely, nuclei such as iron, once they have penetrated a spacecraft, can deposit large amounts of energy locally relative to protons or electrons. In fact, although there can be 10^{-3} to 10^{-5} times fewer iron nuclei than protons, at low and intermediate depths their relative potential for damaging humans can exceed that of protons.

The GCR in our solar system varies substantially as a function of the level of solar activity. This variation is due to the solar wind, which varies with an approximate 11-year cycle. During this cycle the outward flow of solar particles is directly related to the number of observed solar events. When this solar wind increases, more particles (and a greater interplanetary magnetic field) exist to interact with the influx of GCR. This interaction removes some of the lower energy GCR. The higher energy GCR, upon interaction with the solar wind, may lose energy but will still tend to travel in the same direction. The result is that, at times of solar maximum, the GCR energy distribution in the inner solar system has a lower energy fluence than at times of solar minimum. The consequence is that, at solar minimum, doses can be on average two to three times higher than at solar maximum. This effect is even more pronounced as humans travel closer to

the Sun, where the density of the solar winds increases. This variation in solar cycle compared to the August 1972 solar event is shown in Figure 6.8-7.

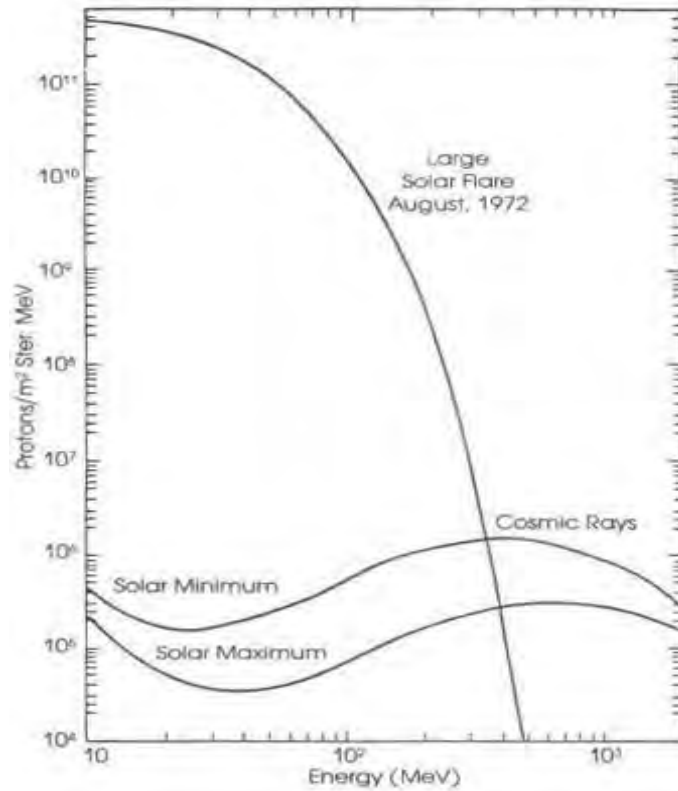


Figure 6.8-7 Fluence of GCR at solar maximum and minimum vs. Aug. 1972 solar event.

Plots of the solar cycle and corresponding neutron measurements at the Kerguelen Islands observatory in the South Indian Ocean are shown in Figure 6.8-8. These neutron levels are caused by interactions of GCR with the Earth's atmosphere and can be used as an indicator of the intensity of the GCR. Doses from the GCR in interplanetary space are estimated to range from 0.3 Sv/yr during solar maximum to about 1 Sv/yr during solar minimum (Townsend et al., 1992).

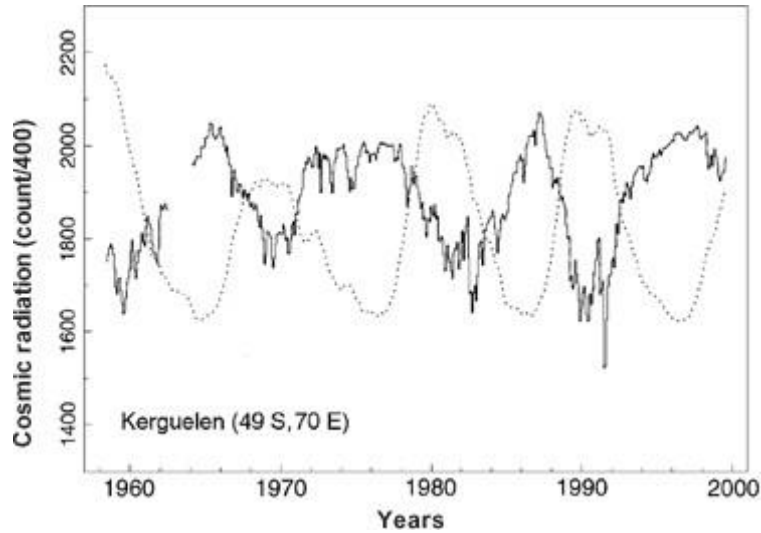


Figure 6.8-8 Plots of the solar cycle (dots) and corresponding neutron measurements at the Kerguelen Islands (solid line).

Currently NASA uses the Badhwar-O'Neill model (Badhwar & O'Neill, 1991) to predict the intensity of GCR. This model was updated in 2007 (O'Neill, 2007) and relies on either Advanced Composition Explorer satellite measurements or measurements from the ground neutron monitor in Climax, Colorado, to estimate a solar modulation parameter ($\Phi(t)$), in units of volts. This parameter is related to the energy required for GCR particles to propagate to a point of interest in our solar system.

6.8.2.2.3 Trapped Particles

The rotation of the Earth's molten iron core creates a magnetic field that extends thousands of kilometers into space. As charged particles interact with this magnetic field, their original direction is altered according to their speed (energy), charge, and mass along the magnetic field lines of the Earth.

The two main types of particles in these trapped belts are electrons and protons. Of these, the protons are of greater concern because they have higher energies that can penetrate typical spacecraft hull materials, whereas it is much easier to shield from the electrons. Other ions such as helium, carbon, and oxygen nuclei have been detected in these trapped regions; however, they are of much less concern than protons because of their scarcity.

The magnetic poles are tilted from the Earth's rotational axis, and the radiation belts come closest to the surface of the Earth off the coast of Brazil in an area known as the South Atlantic Anomaly (SAA). The SAA lies roughly at 35 degrees east longitude and 35 degrees south latitude (Figure 6.8-9), but drifts in a northwest direction at the rate of approximately 0.19° W/yr, 0.07° N/yr.

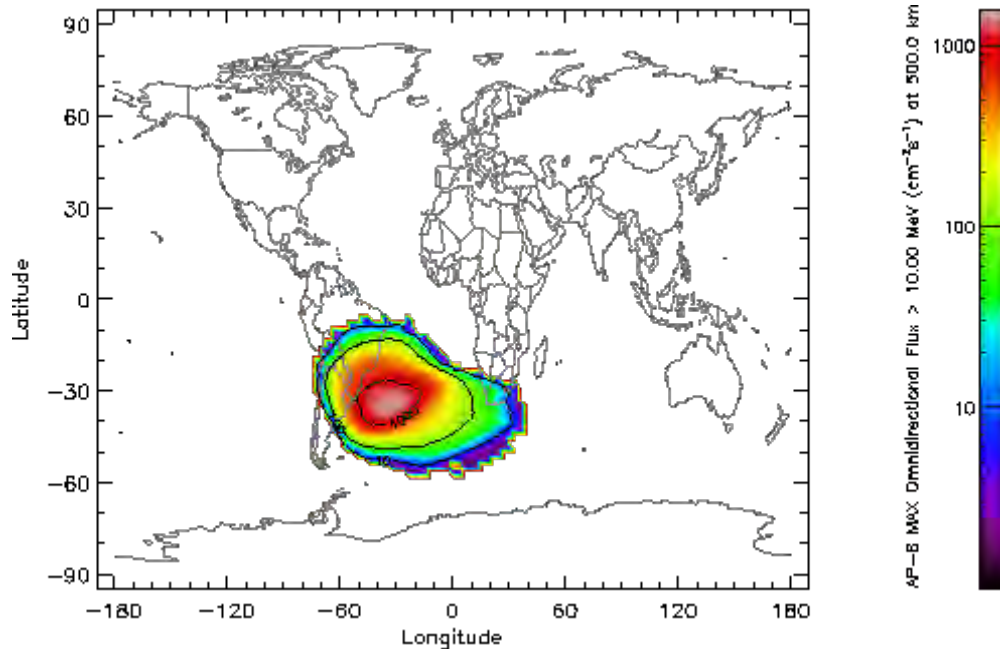


Figure 6.8-9 World map of the AP-8 MAX integral proton flux >10 MeV at 500 km altitude
 (<http://www.spennis.oma.be/spennis/help/background/traprad/traprad.html>).

In the SAA, the inner trapped radiation belt dips down to about 200 km above the Earth's surface. This is important for two reasons. First, this low altitude allows some protons to be absorbed in the atmosphere. A further complication is the inherent gyration of protons and electrons along their respective magnetic field lines, which introduces an anisotropy in particle flux at LEO, where a difference over a factor of two exists between the proton flux from the east and the flux from the west. Second, the concentration of protons in this region exceeds the intensity measured at the same altitude at any other part of the globe (due to the concentration of magnetic field lines) and transits through this region can significantly add to radiation exposures. In addition to altitude and orbital inclination, the integrated dose is a function of solar cycle. Increases in solar activity expand the atmosphere and increase the losses of protons. Therefore, trapped radiation doses in LEO decrease during solar maximum and increase during solar minimum.

Currently, NASA uses AP-8 and AE-8 models to estimate the trapped proton and electron environments, respectively. In general, AP-8 estimates of the orbital proton environment compared to orbital dose measurements show that predictions are correct within a factor of two. In outer regions where the magnetic field is more unstable, the differences between AP-8 and measured values can approach a factor of 10. Comparisons of AE-8 results are complicated by SPEs and geomagnetic storms and the fact that several electron source regions exist. In general, AE-8 overestimates the electron component across all regions. Accuracies at geosynchronous orbits are 10 to 50 times higher than those of measured values, depending on magnetic activities. In LEOs, the AE-8 accuracy is generally within a factor of two, with regions at the inner belt, inner edge being the area of least accuracy (approaching a factor of 10) (Armstrong & Colborn, 2000).

6.8.2.2.3.1 Low Earth Orbit

The radiation environment associated with LEO is well characterized, and Shuttle doses have been predicted to within 25% (Cucinotta et al., 2003). Trapped particles (particularly from the SAA) and GCR are the two main sources of radiation for LEO missions such as the Space Shuttle's. Generally speaking, the radiation environment will consist of about 60% SAA radiation and 40% galactic and solar cosmic rays. However, SPEs can contribute to the radiation environment by increasing the trapped particle radiation. In addition, during the related geomagnetic storms, caused by coronal mass ejections, the magnetic field around the Earth is compressed and higher fluxes of protons and electrons reach lower latitudes. As a result, increased doses can be experienced by astronaut crews in spacecraft or performing EVA. Trajectories of low-inclination flights do not pass the SAA regions of maximal intensities, and although high-inclination flights do pass through the SAA, they spend less time in the SAA region than low-inclination flights. Thus crews in high-inclination flights receive less net exposure to trapped radiation than those in low-inclination flights for a given altitude.

For spacecraft, the presence of Earth's magnetic field causes both the altitude of the spacecraft and the inclination of the orbit to be important in determining the radiation dose rate that would be received due to the GCR. Figure 6.8-10 shows the variation in effective dose at various inclinations. The major effect, shown in the figures, is the shielding afforded by the Earth's magnetic field in deflecting the incoming charged particles of the GCR due to geomagnetic cutoffs. For spacecraft in LEO, the 300-km (186 miles) orbit curves are applicable. At an altitude of about six Earth radii (approximately geosynchronous orbit), this geomagnetic shielding effect disappears.

Note that with longer missions the preferred altitudes are higher to reduce atmospheric drag on the craft. In these "higher" LEOs the doses can double between orbits that differ in altitude by just 100 km. In addition, the intensity of trapped protons can double from solar maximum to solar minimum.

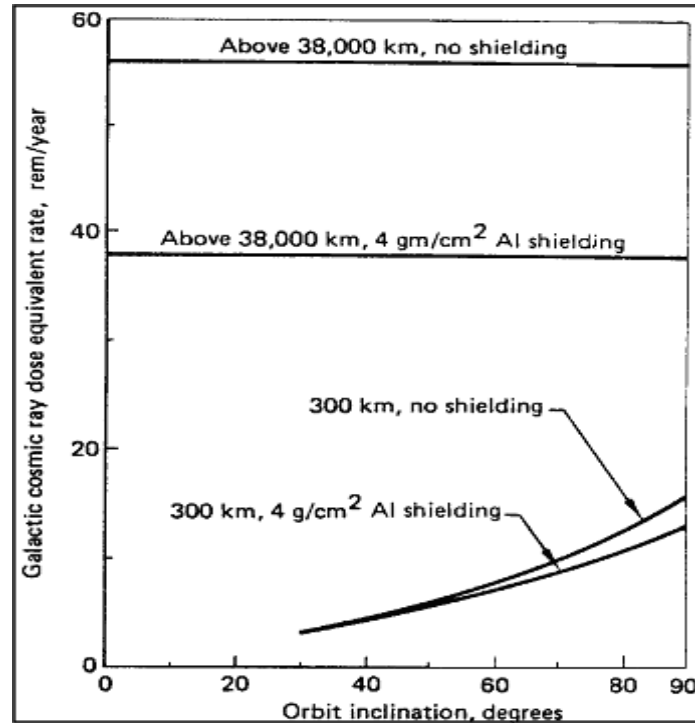


Figure 6.8-10 GCR dose equivalents as a function of orbit inclination (Silberg et al., 1984).

6.8.2.2.3.2 High Earth Orbit

During travel to the Moon or Mars, a spacecraft will be accelerated in LEO and pass through the inner and outer radiation belts as it achieves escape velocity. Of these two belts, the inner one (up to 20,000 km) is of primary concern since it contains protons of sufficient energy to penetrate the spacecraft. As the altitude of the craft increases, so does the energy of these trapped protons. These higher energy particles are worthy of concern since nominal hull shielding may not be sufficient protection. Fortunately, during the manned Apollo missions, the craft transit in these regions was rapid enough that overall dose due to trapped protons was minimized. The average skin dose for those missions was 4.1 mGy, most of which was attributable to the radiation belts (Bailey, 1976).

6.8.2.3 Lunar Missions

The Earth's magnetic field protects our planet from most radiation by deflecting energetic charged particles. During lunar transit, a spacecraft will travel through the radiation belts, subjecting the spacecraft and crew to a higher flux of trapped particles. Beyond the belts, the spacecraft and crew are unprotected from solar particles and higher levels of GCR. However, once crewmembers are on the lunar surface, the Moon itself offers 2π protection from radiation encountered in space, but no atmospheric or magnetic field protections from radiation.

Current plans are for the next human lunar landing to occur by 2020, the approximate date of the next predicted solar minimum (cycle 25). Although the risk of a dangerous

solar event occurring during this time is less, the proposed longer missions increase that risk. In addition, during this time the GCR dose rate will be at high levels. There is some concern that when high-energy GCR particles strike the lunar surface they will fragment, and increase astronaut exposure. This exposure would include radiation from neutrons produced by the interaction of GCR with the planetary surface. The presence of neutrons is particularly worrisome since they can be highly penetrating in dense materials and, upon interaction with water (i.e., human tissue), they lose large amounts of energy quickly. This happens because the masses of hydrogen and neutrons are similar, which increases the efficiency of energy transfer. Manned Apollo missions were able to avoid the above high-dose situations through a combination of short mission durations and lucky timing. A much better understanding of the lunar environment will be available after the launch of the Lunar Reconnaissance Orbiter in 2009. This probe is equipped with a cosmic ray telescope to analyze the spectrum of particles a lunar habitat would encounter.

6.8.2.4 Planetary Missions

The Earth's protection from radiation is provided by its atmosphere and magnetic field. Planets such as Mars have little or no magnetic field to offer protection from energetic charged particles. Mars has a thin atmosphere of mostly carbon dioxide that affords some protection from SPEs as well as some GCR. Aside from this, concerns are similar to those for lunar missions. With chemical propulsion, passage through the radiation belts contributes minimally to the overall mission dose. However, due to the length of time taken to travel from Earth to Mars, consideration should be given to the intensity of the GCR as it relates to the solar cycle. This is in addition to concerns about doses due to neutron production in the atmosphere and on the Martian surface.

Unlike projections for a stay on the Moon, a 600-day Martian stay means that a more equal weighting needs to be applied to the SPE and GCR shielding components (Campbell, 1992). Radiation dose received during a Mars missions will be affected by mission duration, the environment, and spacecraft shielding. A longer stay that does not incorporate a Venus fly-by would expose the crew to higher amounts of GCR and bring crews closer to the Sun, where SPEs have a higher intensity and arrive earlier. However, doses received from solar flares in recent history would be minimized if a 25 g/cm² storm shelter is provided.

Some direct measurements of the martian radiological environment exist from the MARIE experiment flown on the 2001 Mars Odyssey Orbiter. MARIE measurements indicate that in December of 2002, during a time of very low solar activity, the GCR dose rate was 21 mrad/d. This is within 10% of model predictions. In July of 2002, during a period of enhanced SPE, dose rates at their maximum exceeded 1000 mrad/d. In the future, surface measurements will be conducted by the Mars Science Laboratory.

In addition to generic estimates of surface dose rates, specific SPE dose rates have been estimated (Parsons et al., 2000) in interplanetary space. Analyses of the tissue dose rates from the 1972 event to a typical spacecraft thickness outside the Earth's magnetosphere show 6 cGy/h to 20 cGy/h for bone marrow and skin, respectively. These dose rates are sufficient to elicit concern that they might cause acute symptoms in the crew (see section

6.8.3). This same event incident on a craft on Mars would be far below any acute thresholds.

6.8.2.5 Extravehicular Activity

During EVA, astronauts are not afforded the same craft shielding as during the rest of the mission. This presents some unique hazards, which must be separately assessed. With even the thin shielding provided by a spacecraft hull, the low-energy components of GCR, trapped protons and electrons, and SPEs do not penetrate the spacecraft and are therefore of no concern. However, spacesuits cannot be constructed thick enough to shield out all of these particles. As described in section 6.8.2.1, the intensity and onset of an SPE cannot be predicted. An SPE can also intensify the trapped protons and electrons in LEO. As a result, SPEs are the major concern during EVAs. Therefore, monitoring and work planning must be performed to protect crews during EVAs. For additional discussion see section 11.4.2, “EVA Safety, Radiation.”

6.8.2.6 Radioactive Devices

Radiation sources on board spacecraft can be put into three main categories:

- Sealed sources
- Power sources
- Induced radioactivity

6.8.2.6.1 Sealed Sources

Sealed sources refer to small radioisotopes (small in physical dimensions and small in radioactivity) commonly used in instruments as calibration sources. Currently, only two sources of sealed radioisotopes are routinely used in the human space program. These are Cm-244 and Am-241, which are used as a calibration source for the ISS Tissue Equivalent Proportional Counter and as a component of a smoke and aerosol detector, respectively. The very low activity of these sources presents a nominal hazard to humans and contributes levels of radiation that are substantially below the daily doses delivered from other sources. It is expected that any sealed sources used in space activities will be of similar low activities and in small quantities that can be easily shielded. Special attention should be given to any sources that are not sealed, such as radiopharmaceuticals or sources that are easily friable. Many of these sources can present a nominal hazard outside the body but if ingested or injected can present large short- and long-term hazards. Note that in general the levels required for these effects are well above those found from incidental exposure from a single sealed source, and this should be considered a nominal hazard.

6.8.2.6.2 Power Sources

Power sources may be further categorized as either a radioisotope source or a nuclear reactor. The most common isotopic power source is the radioisotopic thermoelectric generator (RTG). An RTG device uses highly radioactive sources to deposit heat in some medium that either drives a piston or heats a thermocouple junction to generate

electricity. Apollo missions 12 through 17 used a Pu-238 source for a lunar surface experiment (English & Liles, 1972), which led to a small neutron dose. Higher doses of neutrons were received by the crew of Apollo 13 because the lunar landing was aborted and the experiment was not delivered to the lunar surface; therefore the crew was exposed in transit both to and from the Moon. Nuclear reactors generate power in larger amounts and more efficiently than radioisotopes. Either of these two generators can release fatal amounts of radioactivity if it is not properly contained, even after the unit no longer produces a significant amount of electrical power. Nuclear reactors have the advantage of containing very low levels of radioactivity until the unit is activated (i.e., fission is begun), whereas radionuclides in RTGs will start at very high levels and decay over time. However, nuclear reactors will also induce radioactivity in materials surrounding the device. Shielding astronaut crews from either of these sources is essential since efficient transmission of power may demand relatively close proximity of crewmembers to the generator. At a minimum, the side of the generator facing human activity needs a relatively high level of mass to attenuate the radiation. Another concept involves tethering or attaching the generator to a boom. This reduces the amount of shielding required by cutting down the solid angle of the source to human activity. Placement of the generator on a planetary surface allows that surface to be used as a radiation shield. Digging into the ground or using existing terrain minimizes the amount of shielding that would have to be transported from Earth.

6.8.2.6.3 Induced Radioactivity

Induced radioactivity refers to the fact that radioactivity may be induced in some materials in a spacecraft as a result of their interactions with high-energy radiations. When a particle (or photon) has sufficient energy, it can interact with the nucleus of an atom, resulting in an unstable atom. An unstable atom will emit an electron, positron, photon, neutron, proton, or alpha particle in the process of returning to stability. In space, the higher energy GCR is the primary source of activation. Although numerous particles may activate spacecraft components, such interactions are in general quite rare, and present a small increase in the existing radiation field. In one study of GCR (Plaza-Rosado, 1991), activation in various spacecraft components and various ingestible items was compared. The investigators found that induced radioactivity was below acceptable levels on Earth.

6.8.3 Physiological Effects of Ionizing Radiation Exposure

Radiation exposure in space can have effects on crews both immediately and for the remainder of their lives. Fully quantifying these effects is difficult. Even assuming that exact measurements of radiation exposure can be known, variations still occur in the outcome due to individual sensitivities and differences in the efficiency of damage caused by different types of radiation. In addition, there are outcomes of which the full range of biological effects is still poorly understood. Two broad classifications are commonly used for radiation exposure, deterministic (or nonstochastic) and stochastic. Deterministic effects occur after relatively large radiation exposures, i.e., a threshold exists for the expression of their effect. Stochastic effects are believed to be the result of damage to a single cell, and the expression (severity) of that damage is considered to be independent

of the amount of radiation exposure, but the probability of damage increases with radiation exposure. Thus, for stochastic effects, a risk is associated with the smallest measurable exposure to an individual. The term “radiation quality” is used here to describe the combination of radiation energy and particle types as they influence damage to tissue and cells.

6.8.3.1 Human Response

Just as different types of radiation have different impacts, different tissues respond differently to radiation insult. In addition, individual sex, age, and health may play a part in sensitivity to radiation exposure. Herein these radiation insults are divided into early and late effects, in accordance with how they may affect a mission. What follows is a general discussion of some of the impacts of radiation exposure that points out items of concern in planning activities that will occur during radiation exposure. This list is in no way comprehensive. Different probabilities exist for the occurrence of stochastic radiation effects in various organs and tissues. For the purpose of dose assessment, different tissues have been assigned weighting factors. These tissue weighting factors (w_T) attempt to equate the impact an individual tissue has on the entire human system relative to the previously described dose equivalent. Tissue weighting factors are shown in Table 6.8-2. These weighting factors reflect the relative fatal cancer probability of each tissue (NCRP 132, 2000). They are used by multiplying the dose equivalent to the organ in question by its weighting factor, as shown in Equation 6.8-1. The result is the effective dose equivalent (EDE).

$$EDE = \sum_T w_T H_T \quad \text{Equation 6.8-1}$$

This EDE attempts to account for the overall radiosensitivity of the individual and is used to estimate risk of mortality.

Table 6.8-2 Weighting Factors for Different Tissues

Bone Surface Skin	Bladder Breast Liver Esophagus Thyroid Remainder*	Bone Marrow Colon Lung Stomach	Gonads
0.01	0.05	0.12	0.20

*The remainder is composed of adrenals, brain, small intestine, large intestine, kidney, muscle, pancreas, spleen, thymus, and uterus. In cases where one of the remainder tissues receives doses in excess of any of the 12 organs in the table, a weighting factor of 0.025 is applied to that organ with the remaining 0.025 applied to the rest of the remainder organs (NCRP 132, 2000).

6.8.3.1.1 Early Effects

Early effects are responses to radiation exposure that can occur over a period of a few hours to many days after the initial exposure. These generally occur after acute exposures above a dose threshold, corresponding to a significant fraction of cell or tissue loss. Most have the potential to be mission-disrupting and even life-threatening as a direct or indirect result of radiation damage. No incidence of early effects is considered acceptable. SPEs are considered the major source resulting in the onset of early symptoms. Of these, fatigue, nausea, vomiting, diarrhea, and loss of appetite are the observable symptoms most likely to occur, especially for an unexpected exposure during EVA or a surface mission. Explained below are some of the concerns associated with a large SPE. In general, maintaining the radiation dose below 0.5 to 1.0 Gy limits the most detrimental effects of a short-term exposure such as the August 1972 event. However, it is important to remember that a wide range exists in what is considered a “safe level” of risk for early effects of radiation exposure. This results from individual variability in sensitivities due to body mass, sex, and even a genetic predisposition to increased radiation sensitivity. Numerous other factors can increase or decrease this sensitivity. A summary of early effects is listed in Table 6.8-3. The values for the thresholds of the effects listed below were obtained from Earth-bound populations. NASA has developed short-term limits to protect against the early effects that may have an impact on crew health and mission success. These limits may not protect space travelers fully because of uncertainties associated with the compounding effects of space flight, such as weakened immune systems, nutrition, microgravity, and other factors. Currently, information is lacking to judge the effects of compounding factors on radiosensitivity.

Prodromal Effects: The term “prodromal” has been used to describe transient periods of nausea, vomiting, diarrhea, and loss of appetite that are usually associated with large exposures. The severity of these symptoms is related to dose, above a threshold. The whole-body absorbed doses that induce loss of appetite, nausea, and emesis in 50% of the population exposed are 1.08 Gy, 1.58 Gy, and 2.4 Gy respectively (Ricks, 1975). Prodromal effects have not been noted for terrestrial exposures at doses below 0.5 Gy. The variability of radiation types is not well understood, except that LET is not a good predictor of the effect.

Hematological Changes: The bone marrow is very sensitive to radiological damage, but the cell lines (hematopoietic stem cells) that give rise to red and white blood cells become more resistant the more specialized they become. Damage to the marrow has consequences for numerous cell lines over large areas of the body. For this reason, NASA has developed a short-term limit for doses to the blood-forming organs. The NCRP 132 (2000) has reported that primitive quiescent, multi-potential progenitors with repopulating capability are relatively radiation-resistant, with the probability of killing 37% of the cells ($D_{0.37}$) in the range of 0.9 to 1.1 Gy. Less quiescent, more mature, but multipotential colony-forming units that form colonies in 7 days are more sensitive, with resistance in the range of 0.5 to 0.9 Gy. More mature, actively cycling cells with lineage-restricted macrophage colony-forming cells are much more radiation-resistant, with a $D_{0.37}$ well above 1 Gy. All absorbed doses given are for low-LET radiations. The primary effects of acute exposures are the killing of platelets and white blood cells. The threshold

for significant effects is about 1.5 Gy, but changes in white blood cell counts can be detected much earlier (National Research Council, 1996).

Skin Changes: Skin reactions can be particularly problematic to an astronaut because of physical irritation and psychological distress from the visibility of this effect. The four main responses in order of increasing dose are erythema, dry desquamation (shedding of skin), wet desquamation, and lesions. The threshold for erythema is about 2 Gy. Four to 6 weeks after exposures of about 5 to 6 Gy, dry desquamation begins. The threshold for the onset of wet desquamation and lesions is on the order of 20 Gy.

Central Nervous System and Behavioral Effects: Radiation can cause effects on the central nervous system. However, to date not enough information exists to draw conclusions about the possible effects or the dose thresholds for such effects. Behavioral changes have been observed in mice at a dose of about 0.2 Gy and iron ions are more successful at producing this effect. At extremely high doses (20 Gy), radiation directly destroys the central nervous system and death occurs within hours.

Table 6.8-3 Dose Levels for Various Early Effects

Effect	Dose
Blood count changes	0.5 Gy
Anorexia	1.0 Gy
Vomiting (threshold)	1.0 Gy
Nausea	1.5 Gy
Fatigue	1.5 Gy
Mortality (threshold)	1.5 Gy
Bone marrow failure	3.0 Gy
LD _{50/60} * (with minimal supportive care)	3.2 – 3.6 Gy
Skin damage	5.0 Gy
LD _{50/60} (with supportive medical treatment)	4.8 – 5.4 Gy
100% mortality (with best available treatment)	8.0 Gy
CNS – death within hours	20 Gy

* The LD_{50/60} is that dose at which 50% of the exposed population will die within 60 days. From NCRP 98, 1989).

6.8.3.1.2 Late Effects

Late effects in this context are those that would occur after the mission and over the lifetime of the astronaut. They are thought to take years to be manifested in the individual. Protection against the risks of late effects may have an impact on missions in the form of duration and crew selection.

Eye: Although numerous effects of radiation exposure to the eye have been noted, the induction of cataracts is the one most often reported. This is because radiation damage is easy to detect and its threshold of induction is about 2 Gy, for a single exposure. This is the lowest dose of all the observed consequences to the eye. The induction of cataracts is not considered to be likely to have an impact on the mission. To date, cataract formation is the only health detriment that has been associated with space radiation exposure (Cucinotta et al., 2001).

Cardiovascular Disease: A link has been made between radiation exposure and the potential for development of cardiovascular disease. Studies on animals have shown changes in vasculature beginning at 0.5 Gy. A clear link has been established between low-LET radiation exposures and cardiovascular disease. However, quantitative effects of high-LET radiation have not been established.

Sterility: Spermatogonia and oocytes are particularly sensitive to radiation damage. Effects on these cells may not be observable for about 2 months, and if recovery occurs, it may take up to 2 years. Men and women respond differently because of their gonad locations within the body and inherent sensitivities of these cells. Temporary sterility is considered to be induced in the range of 0.5 to 1 Gy and permanent sterility at about 1.5 Gy in women and above 6 Gy in men. In women the risks increase with age. There is considerable uncertainty in these numbers because the effects of the rate of radiation exposure and radiation quality are unknown. Dividing doses into fractions separated by a short repair time does not seem to decrease the incidence of sterility (NCRP 132, 2000).

Cancer: Much data has been collected and there is a clear link between large radiation exposures and cancer induction. However, data conflicts on whether long-term exposure to low-LET radiation leads to reduced or increased incidences of cancer induction in workers, when compared to naturally occurring rates (Howe et al., 2004). Unfortunately, the risk of cancer induction by the space radiation environment is not well known. Therefore the level of risk is computed from models (derived from animal and human population studies) and radiation dosimetry based on Earth experiences. In general, for exposures from the same radiation field, each type of cancer has a different rate of occurrence. This is partly because different cells have different inherent sensitivities and partly because of their locations in the body (some sites are better shielded). Men and women will have different cancer risks for the preceding reason, and therefore NASA incorporates age and gender dependence in its risk models. Such models have been developed to include risks of death due to all types of cancer.

Heredity: Extensive studies in fruit flies and mice have shown that alterations in the animal's genome can be passed along to subsequent generations. From mouse studies, a dose of 1 Sv has been established as the dose expected to double the incidence of naturally occurring effects on the progeny of exposed individuals. Extrapolation to

humans suggests that this dose may be closer to 2 Sv. However, to date studies on atomic bomb survivors have failed to correlate radiation exposure with any genetic detriment at any dose (Preston et al., 1997).

6.8.3.1.3 Dose Rate

The effects of dose rate have been extensively applied in the therapeutic use of radiation and may have applications in space travel. The first of these applications is the rate over which a radiation exposure is received. The human system can withstand larger doses of radiation if they are delivered at low dose rates. In an attempt to account for low dose rates, the dose and dose rate effectiveness factor has been introduced into NASA's risk model (NCRP 132, 2000). A value of 2 has been assigned to the effectiveness factor, indicating that low-LET radiations at low dose rates have half the mortality potential of high-rate doses. Although these studies were performed with low-LET radiations, it is possible that similar results apply to the higher LET radiations and dose rates applicable in space. However, large uncertainties are still associated with these factors.

6.8.3.1.4 Risk and Desensitization

The risks of cancer mortality and desensitization are related to the radiation dose. Risk varies by endpoint observed as well as by age and sex of the individual. Unlike most hazards in the space program, long-term radiation hazards are not abated by a return from space.

The probability or risk an individual has of incurring a specific radiation-related symptom varies with time. It is also important to point out that not all the risks associated with radiation exposure are known. NASA currently uses a gender-based risk model, but these models have large uncertainties, in part because some data has been extrapolated to humans from animal studies. Also, about 40% of the atomic bomb survivors are still alive and continually providing data related to long-term effects of radiation exposure.

Complicating risk estimates is that some evidence exists for a beneficial effect of low long-term radiation exposures. This effect is termed hormesis. Studies show (Ducoff 2002) that doses up to 3 to 4 times the U.S. national average background dose can cause the body's immune system to ramp up, giving the individual added protection during times of low-level radiological insult. In addition to hormesis, the fractionation of doses offers damaged cells time to repair themselves between doses. This may have implications for crew rotations during unexpected long-term SPEs.

Another important modifier of radiation exposure has been reported by Seed et al., 2002. It has been shown that the dose required to kill specific fractions of blood cells in animals increases with extended exposures. This suggests that cells adapt and become more proficient at repair under the long-term stress of radiation exposure. In addition, complete reversals of these protective effects occur after radiation exposures have stopped. The possibility exists that these cellular responses may translate to entire individuals, but this has yet to be observed.

6.8.4 Exposure Limits for Ionizing Radiation

6.8.4.1 ALARA Mandate

Exposure of astronaut crews to radiation must be maintained as low as reasonably achievable (ALARA). This is intended to ensure that each exposure to radiation is justified and limited so that astronaut exposures do not approach radiation limits and that such limits are not considered tolerance values. The primary functional application of the NASA ALARA program is to prevent risks that could jeopardize the mission and minimize long-term risks to levels as low as possible based on moral and financial issues. Given the uncertain consequences of radiation exposures and risk models, cost-effective methods to ensure that exposures are maintained ALARA are essential.

6.8.4.2 Early-Effect Dose Limits

Table 6.8-4 lists 30-day and 1-year dose limits that minimize short-term effects of radiation exposures.

**Table 6.8-4 Dose Limits for Short-Term or Career Non-Cancer Effects
(in mGy-Eq or mGy)**

<u>Organ</u>	<u>30-day limit</u>	<u>1-year limit</u>	<u>Career</u>
Lens*	1000 mGy-Eq	2000 mGy-Eq	4000 mGy-Eq
Skin	1500	3000	6000
BFO	250	500	Not applicable
Heart**	250	500	1000
CNS***	500	1000	1500
CNS*** ($Z \geq 10$)	-	100 mGy	250 mGy

Note that RBEs for specific risks are distinct, as described above.

*Lens limits are intended to prevent early (< 5 yr) severe cataracts (as from a solar particle event). An additional cataract risk from lower doses of cosmic rays exists for subclinical cataracts, which may progress to severe types after long latency (> 5 yr) and are not preventable by existing mitigation measures; however, they are deemed an acceptable risk to the program.

**Heart doses were calculated as the average over heart muscle and adjacent arteries.

***CNS limits should be calculated at the hippocampus.

Short-term dose limits are imposed to prevent early effects of radiation exposure (such as lethality, vomiting, and nausea). Currently these limits are determined by applying Earth-based limits to the HZE space environment and ignoring variation among individuals. Establishing limits is difficult because of the lack of human data, extrapolation from animals, variability in individuals (especially between sexes), and response to mixed radiation fields. It is generally assumed that these estimates do not provide adequate levels of protection, and more data related to these areas is required.

Traditionally the BFO is used as a critical organ for dose computations concerning short-term effects. This is because it is one of the more sensitive organs; effects on it have consequences throughout the body, especially from a weakened immune system; and the BFO is found in large regions of the body. The only organs more sensitive to radiation

are the breast and thyroid, but since the BFO is a more mission-critical organ, computations are often carried out on the BFO. Following the dose limits to this organ will limit all effects that have an impact on short-term missions.

6.8.4.3 Late-Effect Dose Limits

The long-term effects of radiation exposures are cancer induction, non-cancer mortality, and hereditary effects. However, the exposure-related risks are not precisely known and so in keeping with ALARA, conservative dose limits are applied. Exposure limits are based on studies of animals and humans, and involve mostly low-LET radiations. A straight application of these effective doses has been made to the space environment. Currently, a 3% excess risk of exposure-induced death (REID) from fatal cancers is the basis of these whole-body dose limits. It is NASA's policy to ensure that this risk limit is not exceeded at a 95% confidence level using a statistical assessment of the uncertainties in the risk-projection calculations to limit the cumulative effective dose (in units of Sievert) received by an astronaut throughout his or her career. This extra level of conservatism (applying the 95% confidence interval) accounts for uncertainties in epidemiology data, dose-rate factors, individual biological response, organ dose assessment errors, and uncertainties associated with measurement and the environment. The REID can be obtained by Equation 6.8-2:

$$REID = \sum S_a \times r_a \quad \text{Equation 6.8-2}$$

where S_a represents the (doubly decremented) lifetable probability of surviving to age a and r_a is the estimated risk of dying from radiation-related cancer at age a after the postulated exposure history. Example career effective dose limits for a 1-year mission for 3% REID from radiation carcinogenesis are given in Table 6.8.5.

Table 6.8-5 Example Career Effective Dose Limits for 1-yr Mission for Women and Men and 95% Confidence Level

<i>Women</i>			
Age, yr	Median Dose Limit Estimate (mSv)	95% CL for SPE Exposure (mSv)	95% CL for GCR Exposure (mSv)
30	470	174	124
35	550	204	145
40	620	230	163
45	750	278	197
50	920	341	242
<i>Men</i>			
Age, yr	Median Dose Limit Estimate (mSv)	95% CL for SPE Exposure (mSv)	95% CL for GCR Exposure (mSv)
30	620	230	163
35	720	267	189
40	800	296	211
45	950	352	250
50	1150	426	303

CL, confidence limit. From Cucinotta et al., 2006a, 2006b.

Lifetime limits for cataracts, heart disease, and damage to the central nervous system should also be imposed to limit or prevent risks of degenerative tissue diseases (e.g., stroke, coronary heart disease, striatum aging). Career limits for the heart are intended to limit the REID for heart disease to be below 3 to 5%, and are expected to be largely independent of age and sex. Limits for skin, cataracts, heart disease, and central nervous system (CNS) damage are listed in Table 6.8-4. REID does not give the total impact of the exposure with regard to increased risk of cancer. Therefore, it is useful to quote a second quantity in conjunction with REID that summarizes the average number of years of life lost. Table 6.8-7 shows the average number of years of life lost for men and women of specific ages because of exposure during 1 year to doses corresponding to a 3% REID.

Table 6.8-6 Average Number of Years Lost Due to Doses Corresponding to a 3% REID

Age, yr	E [mSv] for 3% REID (Avg. Life Loss per Death, yr)	
	Men	Women
25	520 (15.7)	370 (15.9)
30	620 (15.4)	470 (15.7)
35	720 (15.0)	550 (15.3)
40	800 (14.2)	620 (14.7)
45	950 (13.5)	750 (14.0)
50	1150 (12.5)	920 (13.2)
55	1470 (11.5)	1120 (12.2)

6.8.5 Protection from Ionizing Radiation

The most effective measures for minimizing doses are taken before any exposure, through accurate knowledge of the radiation environment, planning of work, spacecraft design, individual education, and written rules and policies. Characterization of the radiation environment is an ongoing assignment. In the case of SPEs, both the timing and intensity of these events are still unpredictable, and for spacecraft and planets the environment may not yet have been characterized, either because the data on how particles interact with various materials is lacking or because the environment itself has not been reliably measured (as is the case for low-intensity high-Z particles).

A limit of 3% excess lifetime fatal cancer risk has been established by NASA as an upper limit of risks for astronauts due to radiation exposures. Countermeasures are designed to maintain risk as far below this level as practical and to prevent significant short-term health impacts, including performance degradation, sickness, and death.

6.8.5.1 Planning

Justification and planning of exposures is an important part of ensuring ALARA compliance. In the case of space exploration, because the workforce is small and radiation exposures seem manageable, the benefits of space flight are deemed to outweigh the level of individual risk. Planning of space exposure begins years in advance and should contain the following items:

1. Selection of crew to ensure that planned missions do not exceed Permissible Exposure Levels published in the NASA–STD-3001, Vol 1, 2007.
2. An appraisal and communication of radiation hazards to the crew before each mission
3. Preplanning of flight paths and work to minimize the amount of time crews are exposed to radiation hazards
4. Preplanning of EVA activity to coincide with reduced radiation exposure. In LEO EVAs are scheduled to avoid passage through the SAA.
5. Proper training of crewmembers in knowing the radiation hazards and minimizing those hazards through individual actions
6. Training of crew in the importance of continual monitoring as well as indications of emergency situations involving radiation exposure
7. Development of rules covering radiation exposure contingency plans including action levels and emergency storm shelters
8. Periodic reviews of programs to ensure minimal exposures, adequate planning, and current information
9. Consideration and recording of information that may be useful to future similar activities
10. Proper radiological characterization of the spacecraft environment

Once established action levels are reached, steps are taken to ensure that risks are minimized and limits are not met. Action levels may need to be reassessed, as they may preclude any human missions to Mars. In general these levels are to be set low enough to warn Mission Control before any deleterious early effects occur but not so low as to trigger warnings frequently, which would affect missions. As early as possible in program development, radiation standards and implementation methods must be planned for.

6.8.5.2 Shielding

Shielding (which is largely integral to the spacecraft design process) is currently the most prominent way to ensure ALARA, as it is the one that is usually the most versatile. Several shielding materials and designs have been studied, and the general trends may be useful to spacecraft designers. Any consideration of shields should take into account the fact that radiation is incident on the spacecraft from all directions. Materials containing large amounts of hydrogen have been shown to make the most effective shields. This near-equal mass of protons and hydrogen allows the largest amount of energy transfer in

a single collision. Materials of higher atomic number will tend to effectively scatter incident radiation away from objects directly behind shields with thickness less than those of hydrogenous materials. However, one of the most problematic aspects of space radiation is that of fragmentation. This occurs when high-energy particles collide with target atoms, typically causing the target atom to fragment into smaller atoms. The result can be many types of particles including protons, neutrons, lighter atom fragments, and gamma rays. These fragmented smaller particles are usually of high energy, are more penetrating than the originating particles (due to their smaller size), and tend to travel in a direction similar to that of the incident projectile atom. The flux of particles increases as both parent and daughter particles travel downstream (Armstrong, 1991), which may have increased consequences to crewmembers. This feature makes metals of high atomic number particularly poor shields. In the case of lead, as shown in Figure 6.8-11, it can be seen that to protect against a typical GCR spectrum, a shield must have a density of 20 g/cm² before it begins to reduce radiation doses, while the same quantity of liquid hydrogen reduces doses to about 10%. This is mainly because of the number of fragments created downstream of the lead shield.

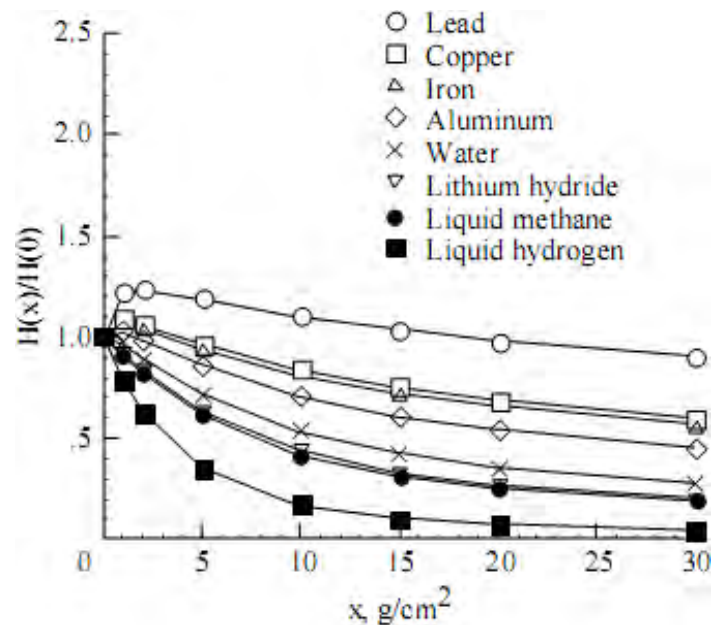


Figure 6.8-11 Doses (H) received behind different shields. $H(x)$, dose behind shield of density x ; $H(0)$, dose with no shield (Wilson et al., 1995).

A NASA working group (Wilson, 1997) found that for radiations of atomic number (Z) below 12 there was no difference between polymers used as shields. For Z above 12, polyethylene was the most effective polymer (of those examined) for thick shielding (greater than 18 g/cm²) configurations and polytetrafluoroethylene was the most effective thin shield, in terms of production of secondary radiations. Indeed, polyethylene has been somewhat successful in shielding the crews' quarters of the ISS from higher than average radiation exposures (Shavers et al., 2004).

It has been suggested that doping of polymers with boron 10 may produce an effective shield against neutrons, because boron-10 has a very high neutron capture cross-section. Although testing did show that boron doping somewhat reduced the neutron component, it was less effective at absorbing HZE particles. On the whole, boron doping may be of little help since the majority of neutrons would be produced from regolith (on planetary surfaces), and shielding from HZE is of much greater concern due to their quantity.

The dose from GCR becomes more significant with increasing mission duration, and the GCR dose can become career-limiting. Designing a spacecraft to be “safe” from GCR requires an unmanageably massive spacecraft. In practice, spacecraft are designed to provide adequate shielding from large known SPEs. Currently, in NASA’s exploration program, the August 1972 event is used. This provides a nominal amount of protection against GCR. In general, protons with energies less than 10 MeV or ions with intensities of less than 3×10^7 particles per cm^2 are not of concern to crew inside spacecraft. However, in the case of a Mars mission, the spectrum of the February 1956 event may represent the greatest dose at the Mars surface because of its high flux of high-energy particles, even though it had only about 10% of the number of protons above 10 MeV that the 1972 event had (Wilson, 1997). The total amount of shielding required to protect crews will depend on the length of the mission and the point in the solar cycle when the mission is expected to take place.

One highly recommended practical application of shielding is to make the area where the crew spends the majority of their time the most heavily shielded area. If this area is relatively small, the mass requirement is minimized. In addition, portable shielding as well as water can make excellent movable temporary shielding for use in emergency SPEs, without increasing launch mass. Designers should consider that SPEs may last days or even weeks, and safe but cramped crew emergency areas may cause other concerns. Crew compartment layout will be important to allow access to food and water, hygiene areas, and essential spacecraft operations for the duration of the SPE.

Several other experimental shield types have been proposed that use coulombic or magnetic forces to shield crews from space radiations. However, none of these has proven to be technically feasible at the current time (Wilson et al., 1997).

6.8.5.2.1 Lunar Considerations

Lunar soil is very similar to aluminum in its shielding properties since its atomic weights are similar. Lunar regolith compositions are shown in Table 6.8-8. Unfortunately, the portion of the lunar regolith that contains atoms larger than aluminum contributes to a greater production of fragments than aluminum. Approximately 90% of the dose behind 20 g/cm^2 lunar regolith is from secondary nucleons. (The unit g/cm^2 is commonly used for “thickness” in order to eliminate the factor of density changes that might occur with varying temperatures.) The study results in Figure 6.8-12 show that the largest reduction per unit mass occurs at regolith thicknesses up to 30 g/cm^2 . The addition of an epoxy to lunar regolith increases its ability to attenuate HZE particles while reducing the number of fragments generated. This combining of materials may maximize crew shielding while minimizing transport costs.

Table 6.8-7 Lunar and Martian Regolith Compositions

	Composition, Normalized Mass Percentage	Density, g/cm ³
Lunar Regolith	52.6% SiO ₂ 19.8% FeO 17.5W% Al ₂ O ₃ 10.0% MgO	0.8–2.15
Martian Regolith	58.2% SiO ₂ 23.7% Fe ₂ O ₃ 10.8% MgO 7.3% CaO	1.0–1.8

From Wilson et al., 1997.

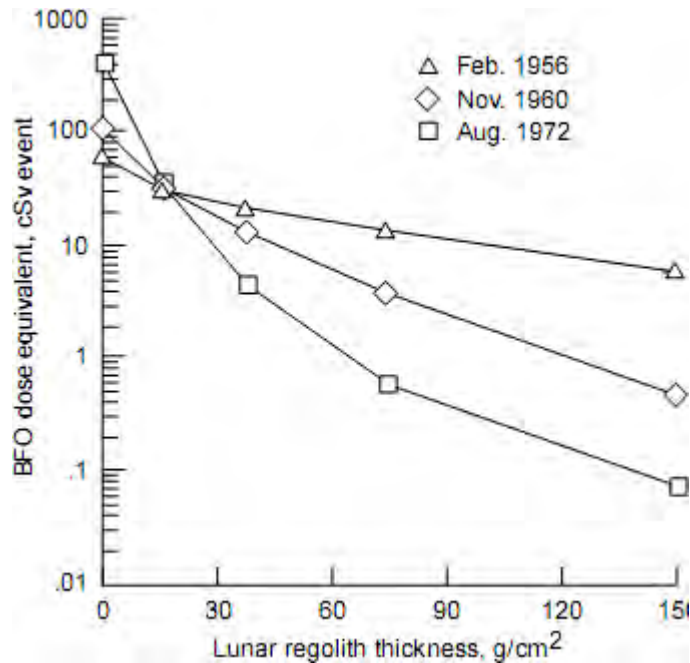


Figure 6.8-12 Effectiveness of lunar regolith shielding (Wilson et al., 1997).

Before an optimum thickness and shielding strategy is selected, the complete mission scenario must be studied in detail. Another technique for reducing added shielding requirements is to locate astronaut crews near cliffs. This has been estimated to greatly reduce radiation doses, especially in time of unexpected SPEs.

6.8.5.2.2 Martian Considerations

Unlike the lunar surface, the surface of Mars is afforded some radiation protection by the martian atmosphere, which is composed mostly of carbon dioxide. Table 6.8-9 shows the

thickness of CO₂ at various altitudes on the martian surface in the straight-overhead direction. The Mars atmosphere (low-density COSPAR model; Smith and West 1983) provides 16 g/cm² of carbon dioxide protection in the straight-up direction with protection increasing to over 50 g/cm² at large zenith angles (toward the horizon) at 0 km altitude. Table 6.8-10 shows the impact of the martian atmosphere on BFO doses for several altitudes and several radiation events. The tables are for doses at 1 AU; those at 1.5 AU may be lower and be affected by atmospheric and nominal craft shielding. The low-density model and the high-density model assume surface pressures of 5.9 mb and 7.8 mb, respectively.

Table 6.8-8 Thickness of CO₂ at Various Altitudes on Mars

Altitude (km)	Low-density model (g CO ₂ /cm ²)	High-density model (g CO ₂ /cm ²)
0	16	22
4	11	16
8	7	11
12	5	8

From Wilson et al., 1997.

Table 6.8-9 BFO Dose (cSv) on the Surface of Mars With Only Atmospheric and Minimal Craft Shielding

Radiation Source	BFO Dose at 0 km	BFO Dose at 4 km	BFO Dose at 8 km	BFO Dose at 12 km
GCR at solar minimum (annual)	10.5 – 11.9*	12.0 – 13.8	13.7 – 15.8	15.6 – 18.0
GCR at solar maximum (annual)	5.7 – 6.1	6.2 – 6.8	6.7 – 7.4	7.3 – 8.1
Feb. 1956 flare	8.5 – 9.9	10.0 – 11.8	11.7 – 13.6	13.4 – 15.3
Nov. 1960 flare	5.0 – 7.3	7.5 – 10.8	10.6 – 14.8	14.4 – 19.1
Aug. 1972 flare	2.2 – 4.6	4.8 – 9.9	9.5 – 18.5	17.4 – 30.3
Aug. 1989 flare	0.1 – 0.3	0.3 – 0.6	0.6 – 1.3	1.2 – 2.6
Sept. 1989 flare	1.0 – 2.0	2.0 – 3.8	3.7 – 6.5	6.1 – 10.6
Oct. 1989 flare	1.2 – 2.7	2.8 – 5.9	5.7 – 11.4	10.6 – 20.5

*High-density model dose estimate—low-density model dose estimate

From Wilson et al., 1997.

Martian regolith compositions are shown in Table 6.8-9 and the reduction in BFO dose due to various thicknesses of martian regolith is shown in Figure 6.8-13 (Simonsen et al., 1990). This added regolith does not offer much more protection from GCR than that already provided by the atmosphere. The shielding effectiveness of regolith is shown to decrease after about 20 g/cm². As in the lunar environment, a way to further reduce the dose is to locate habitats near cliffs. Cliffs can reduce the BFO doses by 2 to 3 cSv/yr for GCR and by about 1 cSv for large solar events (Simonsen et al., 1990). Therefore if additional shielding is required, little is gained by adding more than 20 g/cm² unless it is a vast amount of material.

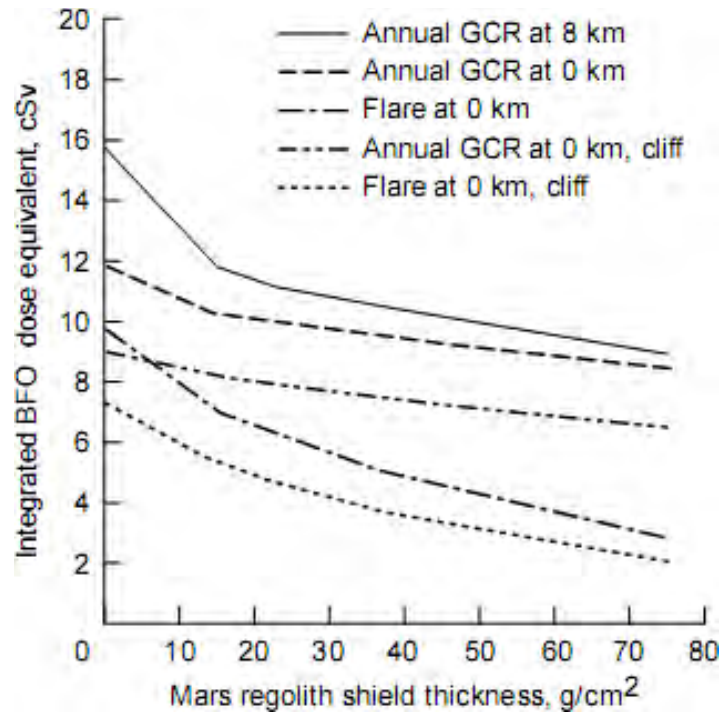


Figure 6.8-13 BFO dose inside a habitat as a function of regolith shield thickness.

6.8.5.3 Radiation Analysis and Design

Currently, NASA uses and requires the use of the model HZETRN 2005 for assessment of the radiological environments involved in space travel. Although this model is only one-dimensional, studies have been performed to validate its effectiveness (Wilson et al., 2005). Implementation of this model should use GCR spectra from 50 GeV/amu to below 10 MeV/amu and charges of at least 1 to 28. For GCR corresponding to solar minimum, the solar modulation potential should be 430 MV. A worst-case solar particle event should be considered in design and planning, which would likely include a storm shelter. As an analysis tool, HZETRN 2005 provides model inputs for several large solar particle events (for example, February 1956, August 1972, and October 1989). Spacecraft shielding performance may be designed to the intensity of the August 1972 event, the hardness of the February 1956 event, or a composite of such events. The shielding design may also change according to the location of the spacecraft in space (LEO, free space, or the martian surface). The optimization of appropriate shield material against GCR for

human protection depends on an improved understanding of biological response, as well as the development of an adequate nuclear cross-section database.

Unfortunately, models are only as accurate as the input data. At this time gaps exist in the knowledge about how variations in dose rate and particle types affect risks to humans. Gaps also exist in NASA's knowledge about particle fluences and interaction probabilities in the unique space radiation environment. Even the relatively stable GCR environment has an uncertainty of about 25%. Efforts are to expand interaction cross-sections as well as the capabilities of HZETRN.

6.8.5.4 Countermeasures

Probably the most well-known and studied natural radioprotectors are retinoids and vitamins (A, C, and E), but hormones (such as melatonin), glutathione, superoxide dismutase, phytochemicals from plant extracts (including green tea and cruciferous vegetables), and metals (especially selenium, zinc, and copper salts) are also under study as dietary supplements for individuals overexposed to radiation, including astronauts (Durante and Cucinotta, 2008). Antioxidants provide reduced or no protection against the initial damage from densely ionizing radiation such as HZE nuclei, because at high LET the direct effect is more important than free radical-mediated indirect radiation damage and it is free radicals that antioxidants counter. However, some benefits are expected to occur from antioxidants' counteracting of persistent oxidative damage related to inflammation and immune responses (Barcellos-Hoff et al., 2006). Some recent experiments suggest, at least for acute high-dose irradiation, that dietary supplements can achieve efficient radioprotection, even in the case of exposure to high-LET radiation. Evidence exists that dietary antioxidants (especially strawberries) can protect the CNS from the deleterious effects of high doses of HZE particles (Rabin et al., 2005). However, because the mechanisms of biological effects are different at low doses, more studies are needed.

6.8.6 Radiation Monitoring and Alerting

To understand the impact of radiation on the short- and long-term health of crewmembers, to report and comply with crew dose limits, and to comply with the NASA mandate of keeping crew exposures as low as reasonably achievable, the radiation environment must be monitored at all times and at multiple locations. In addition, the ability to alert the crew whenever radiation levels exceed established limits must be provided.

Various types of ionizing radiation have different biological effects, according to their energy and mass. In addition, radiation exposure rates will vary with location in the spacecraft because of complex geometries, transient radiation events, and dynamic equipment configurations. Currently, monitoring requires the use of different types of both active and passive detectors to properly characterize the exposure from all of the types of radiation present with respect to temporal behavior, biological effectiveness (radiation quality), and inhomogeneity of the ambient radiation field. Additional important long-term functions of these devices are to provide information to reduce the hazards of future missions and to validate current models.

Currently in the LEO environment, primary concern is given to protons and higher-Z ions. On the lunar and martian surfaces these will continue to be worthy of concern, but interaction with surface materials, as well as the reduced protection afforded by spacesuits compared to a spacecraft, will mean that electrons, neutrons, and energetic nuclear fragments may become a significant hazard. Current crews are not routinely monitored for all these hazards. Therefore, long-term strategies need to include monitoring for all of these radiations by devices that can handle a more hostile surface environment. Consideration should be given to the long-term fixed placement of these monitors. Detectors must be insensitive to the damaging effects of long-term radiation exposures, and consideration should be given to maintaining proper long-term calibration of these devices.

Fixed detectors are not required for carrying out effective monitoring strategies. Portable units may provide effective methods to monitor spacecraft as they are occupied, while reducing total launched mass.

6.8.6.1 Active Radiation Monitoring

The primary advantage of active detectors is that they can give rapid feedback on the ambient radiation intensity. This active monitoring throughout habitable areas identifies high-dose-rate areas to be avoided by the crew, reduces uncertainty in final calculated crew risk assessments, and supports ALARA practices through minimizing exposures and verifying numerical spacecraft shielding models. These active monitors should have a sufficient response time to identify hazardous transient radiation fields. In addition, active instruments are required for reporting time-resolved LET or the surrogate lineal energy spectral distributions. The LET spectrum varies with position in orbit and with local solar weather conditions, and therefore real-time feedback is required for this parameter.

The ability to receive data for estimating the intensity of the radiation environment in interplanetary space (space weather) must be provided in a spacecraft. Space weather monitoring is currently accomplished by downlinking LEO or Lagrange point 1 satellite data to the ground, where it is analyzed by space weather experts. Missions outside of LEO may require onboard space weather monitoring.

6.8.6.1.1 Dose Rate Monitoring

Of particular importance on missions outside LEO is the ability of the crew to have real-time feedback about the radiation environment. This requires not only an easily read display of the current dose rate but alarming features for high dose rates. Changes in the radiation environment that could cause additional crew exposure can occur in periods as short as 1 to 5 minutes.

On longer missions, periods of loss or delays in communication to Mission Control may leave crews vulnerable to transient environments during EVAs or SPEs. Therefore, active alarming detectors that can tolerate high radiation rates are highly recommended. These alarming detectors can be programmed with multiple warning and imminent hazard alarm settings. Current ISS requirements set alarming dose rates to the range of 0.02 mGy/min to 10 mGy/min for three consecutive readings. However, alarm levels for travel outside

LEO may need adjusting because of the radiation environment and/or mission objectives. The conditions in the extreme space radiation environment should be considered since they can greatly exceed levels that can be accurately measured by other active LET or charged particle spectrometers. It is also important that the detector system be small, lightweight, and rugged. Portability is necessary, for the detector is to be moved throughout a spacecraft for mapping the environment or moved from spacecraft to spacecraft.

The presence of high-dose-rate alarming systems does not negate the need for continuous relay of the radiation environment to Mission Control. When feasible, Mission Control feedback will still be critical in identifying subtle changes in the radiation environment that may warn of impending radiological events, and will serve as the basis for implementation of appropriate dose management actions; it also provides a measure of redundancy for dose-rate monitoring.

6.8.6.1.2 EVA Monitoring

Instruments inside the spacecraft cannot monitor a significant portion of the external radiation environment that is important to EVA crew exposures, particularly electrons and low-energy, high-charge particles. These particles are not monitored inside the spacecraft since they are easily shielded by craft materials, but they can be a significant hazard to individuals engaged in EVA. Active external and/or portable monitors (for surface spacecraft) are necessary to provide near-real-time information about the dynamic radiation environment experienced by crewmembers during EVA and to verify models of the crew health risk assessment process. External monitoring must include the capability to monitor for electrons as well as other low-energy radiations that are not normally considered for spacecraft monitoring. The harsh environment in space is also a concern for the design of these monitors.

6.8.6.1.3 Charged-Particle Monitoring

The external fluence of particles of $Z < 3$, in the energy range 30 to 300 MeV/nucleon, and particles of $3 \leq Z \leq 26$, in the energy range 100 to 400 MeV/nucleon, must be monitored. This range contains a large portion of the radiation environment expected for solar particle events, trapped particle radiation, and GCR. Data from charged-particle monitoring is the fundamental environment information required for radiation transport calculations and crew exposure evaluation. All other physical quantities (such as LET spectra and absorbed dose) are not singular, and therefore result in ambiguity and thus increased uncertainty in estimates of crew health risk. Given an accurately measured energy spectrum incident on the spacecraft during an SPE, detailed crew organ exposures and resulting risks can be estimated. Multiple monitoring strategies, including charged particle detectors, will limit the uncertainty of dose measurement in determining crew exposure from a space mission. These measured charged-particle energy spectra are also needed to validate current environment models. For placement of these detectors it may also be necessary to consider the directionality and size restrictions these devices may have.

6.8.6.1.4 Monitoring of Absorbed Dose and Dose Equivalent

The range of linear energy transfer that must be monitored for absorbed dose and dose equivalent is 0.2 to 1000 keV/ μm . This includes the full range expected from primary and secondary radiations of SPEs, trapped particle radiation, and GCR. Tissue equivalent microdosimeters have been used extensively for monitoring crew exposure in space to satisfy this requirement. These devices approximate a set thickness of tissue, allowing predictions of the amount of energy deposited in crewmembers from all types of radiation. This detector can also be fitted with a high-dose-rate alarm, as described in section 6.8.6.1.1, and a spectrometer that can offer a limited idea of the types of radiation present.

6.8.6.2 Passive Radiation Monitoring

Passive radiation dosimetry capable of measuring time-integrated absorbed dose and estimating LET-based quality factors must be provided in each spacecraft. Passive monitoring such as the thermoluminescent detectors and track etch detectors currently used in the space program are useful because they can provide better long-term integration of crew doses, and in some cases better characterization of the radiation environment, than their active counterparts. Because they do not require power, passive dosimeters collect data even when power to other instruments is lost. They can also be important in verifying results from active detectors. The down side is that these instruments are read out using specific processing techniques that require specialized training and equipment. This generally means that results cannot be obtained until crews return to Earth. Furthermore, these devices cannot track the dynamic changes in the environment caused by external influences or changes in the spacecraft, such as stowage reconfigurations.

That said, the results from these passive devices are very useful for their ability to validate computer models, more accurately assess the potential (radiation quality factor) that the radiation environment has for damaging each crewmember, and better characterize the space environment to ensure safer future space missions. In addition, all currently used passive detectors are very small, both in size and mass, and therefore contribute very nominally to spacecraft mass and crew mobility, and they require little or no crew maintenance.

6.8.6.3 Personal Dosimetry

Personal radiation dosimeters must be provided for each crewmember. Currently, on all human missions, each crewmember is provided with a passive personal radiation dosimeter for continuous use during a mission. The results from this personal dosimeter provide a record of the individual crewmember's exposure that is compared with defined exposure limits, provided the crewmember wears a personal radiation dosimeter at all times during the mission. The data from these dosimeters, when combined with data from area radiation monitors and analytical calculations, will ensure compliance with mission and career radiation exposure limits. Uncertainties in risk projections are significantly increased when personal dosimeters are not worn. These dosimeters may be either passive or active.

6.8.6.4 Biodosimetry

Biodosimetry is the process of monitoring changes in the human system as an indicator of radiation risk to that individual. Currently this is performed by quantifying the chromosomal changes in blood samples of exposed individuals. Because different individuals respond differently to radiation, this technique is not yet mature in estimating an individual's dose. However, it can be extremely useful as a qualitative estimate of the radiation exposure of an individual, especially in cases where personal dosimetry has failed. In addition, it can be used as a screening tool to indicate an individual's radio-sensitivity, or to indicate potential post-mission health effects on individuals. However, different techniques for collection and analysis of blood samples can have different results. The inclusion of this form of radiation monitoring in all future human space travel can contribute to biodosimetry becoming an accurate intrinsic tool for estimation of individual radiation risk (Durante et al., 2001).

6.8.7 Radiation Data Reporting

Radiation data must be displayed to the crew and reported to mission operations according to the following guidelines:

- Measured cumulative absorbed dose per minute averaged dose rate, once per minute with latency less than 5 minutes.
- Measured cumulative dose equivalent per minute averaged dose equivalent rate, once per minute with latency less than 5 minutes.

Radiation data is vital for quantifying in-flight risks to the crew. For periods when the crew is not in communication with Mission Control, the crew will need to be able to ascertain the radiation conditions in the spacecraft and take appropriate actions as required. The changes in the radiation environment that could cause additional crew exposure can occur in time periods as small as 1 minute. Providing data to Mission Control when in contact allows ground personnel to advise the crew on appropriate action in response to events such as an SPE, and track crew health throughout a mission.

Dosimetry records for each crewmember must be compiled and maintained by the NASA Radiation Health Officer. These radiation exposure records are necessary to

- Inform crewmembers of their mission and cumulative radiation doses
- Make decisions pertaining to crew selection and provide forecasting for planned missions
- Provide information for making decisions for flight planning
- Evaluate the operational radiation safety program for effective program operation
- Demonstrate compliance with action levels and dose limits
- Provide data for epidemiological studies
- Provide information for making or contesting claims for radiation-induced injury

Because the volume of detailed dose and particle data that will be acquired is very large and the quantity of instrument data storage on board is finite, it is necessary to frequently download instrument data to the ground to ensure that data will not be lost. The detailed particle data will be used periodically to update the estimated cumulative exposure risk of each crewmember and for operational evaluation and real-time flight support. This will provide flight-control personnel with accurate insight into the radiation environment experienced by the crew, especially during periods of heightened space radiation environment conditions. External dose-rate data transferred to the ground is part of the information used to make EVA go/no-go recommendations. Charged-particle, dose-equivalent, and absorbed-dose data taken during missions needs to be archived for post-mission assessment of radiation dose and risk. This data is used to determine the final dose of record for crewmembers, which will be compared with crew exposure limits.

6.8.8 Research Needs

Much is still not understood about the interaction of radiation with the human system. Once mechanisms of damage are discovered, it is possible that effective means of protection from radiation can be developed. At the very least, with improved knowledge the uncertainties in risk estimation can be minimized. Below is a list of the items identified as being required to advance our understanding of radiobiological impacts:

1. The accuracy of knowledge about the current radiation environment needs improving to limit current uncertainties.
Accurate radiation transport calculations require accurate inputs of radiation particle types and energies. Currently there is a lack of detail in the spectral compositions of the GCR.
2. Updated transport modeling procedures are needed to account for three-dimensional scattering of particles.
Currently all dose estimates rely on transmitted fluences modeled by one-dimensional simulations (HZETRN). Greater detail on angular and fragmentation response is needed, particularly in the lunar and martian environments. This model should be expanded to include all primary and secondary components found in the space radiation environment, as well as an expanded database of their interaction cross-sections.
3. SPE models need to be developed to estimate event precursors and spectral intensities.
Improved models and remote sensing capabilities can improve the prediction of acceleration and fluence of ions at points of interest. This could also lead to accurate prediction of quiet times of solar activity and an improved prediction of GCR dose rates at various positions in the solar system.
4. Detectors with an accurate response to neutrons need to be developed.
The neutron component of the radiation spectra, especially on the lunar and martian surfaces, is not well known.
5. Research studies on biological effects of particle or target fragmentation are needed.
An Earth-based equivalent environment is needed to study the long- and short-

term effects of exposure to radiation from heavy ions. It is not yet known if the dose limits need to be raised because these radiations have higher LET or lowered because they have lower dose rates, compared to dose limits developed for the Earth environment. More epidemiological data is needed for radiation-induced cancer in humans.

Currently the cancer induction rate due to heavy ion exposure is not well characterized. For example, it is not known if cellular repair mechanisms can reduce the overall risk or if the production of high-energy secondary electrons by heavier ions increases the cancer risk.

6. The effects of long-term low-dose exposures to space radiations on various biological systems, especially the immune, vascular, and gastrointestinal systems, needs to be determined.

It is a reasonable assumption that compounding health effects of space travel will increase risks caused by radiation exposure. However, this has not been confirmed. Studies are needed that may well confirm that humans can adapt quite well to low-level radiation exposure, as seen in the Earth environment.

7. Existing ion-based therapy needs to be examined for various short- and long-term responses to it.

Greater knowledge is required about how human systems respond to heavy-ion exposure, to determine if such exposure could affect a mission or long-term health care for astronauts with specific health concerns. Numerous facilities that treat cancer patients with protons or heavier ions are in use worldwide. These patients may hold clues to the short- and long-term effects of exposure to these radiations in the space environment.

8. Biomarkers to identify individuals who are at increased risk of health effects from radiation exposure need to be developed.

The benefits here are twofold. Individuals who are much more sensitive than the average person to radiation effects can be screened out of space travel and individuals at increased risk can be more closely observed postflight to head off any ill effects of radiation exposure.

9. The ability of countermeasures to prevent adverse effects of radiation exposure needs to be examined.

Currently no effective countermeasures for preventing either radiation damage or radiation side effects are known. However, antioxidants may reduce long-term cancer risk and drugs that prevent vomiting may be developed.

6.9 NON-IONIZING RADIATION

6.9.1 Introduction

Non-ionizing radiation (NIR) is any type of electromagnetic radiation that is not sufficiently energetic to ionize atoms or molecules. It consists of the broad band of electromagnetic radiation having wavelengths in the range of 10^8 to 10^{-7} meters (Figure 6.9-1). This section describes the NIR environment, sources, physiology effects, limits, and countermeasures.

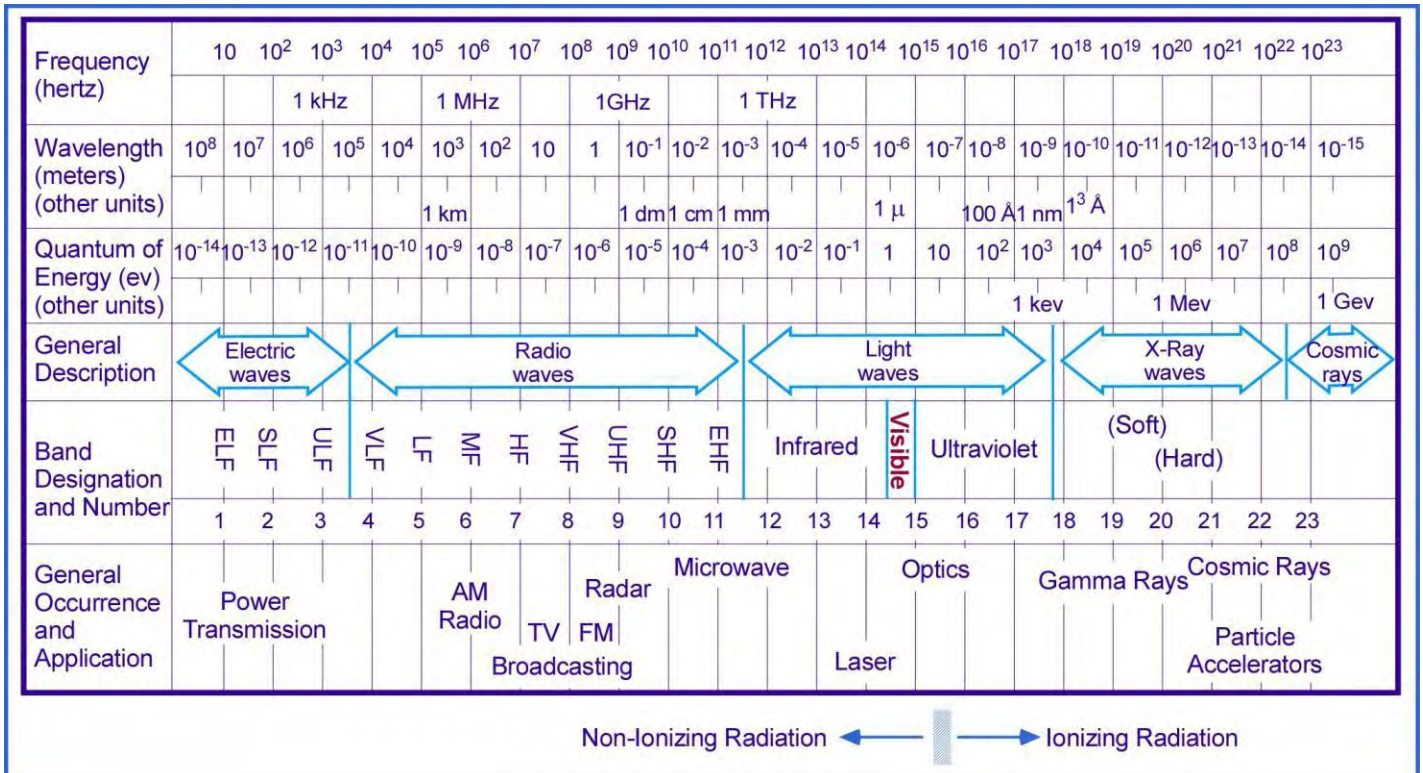


Figure 6.9-1 The electromagnetic spectrum (Graf, 1974).

For purposes of health protection, NIR can be divided into several wavelength ranges, as shown in Table 6.9-1.

Table 6.9-1 Wavelength Ranges of Non-ionizing Radiation

Optical radiation	
Ultraviolet radiation (UV)	100 – 400 nm
Visible radiation	400 – 760 nm
Infrared radiation (IR)	760 nm – 1 mm
Microwave radiation	1 mm – 33 cm
Radio frequency (RF) radiation	33 cm – 3 km
Extremely low frequency radiation	> 3 km

6.9.2 Non-Ionizing Radiation Sources

The NIR experienced during a space mission emanates from two different types of sources, natural and human-made.

6.9.2.1 Natural NIR Sources

Continuous Solar Emissions – The Sun emits a broad spectrum of electromagnetic radiation (Figure 6.9-2). Solar radiation rapidly increases in intensity from the far UV (approximately 100 nm) to the visible (approximately 760 nm) and peaks in the visible region (approximately 550 nm). The UV, visible, and IR conditions in space are harsher than those on the Earth’s surface because space lacks the shielding from solar irradiation that is provided by the Earth’s atmosphere. Electromagnetic radiation in the radio frequency range is also emitted by the Sun but is of low intensity. Radioflux is typically recorded on Earth at 2800 MHz.

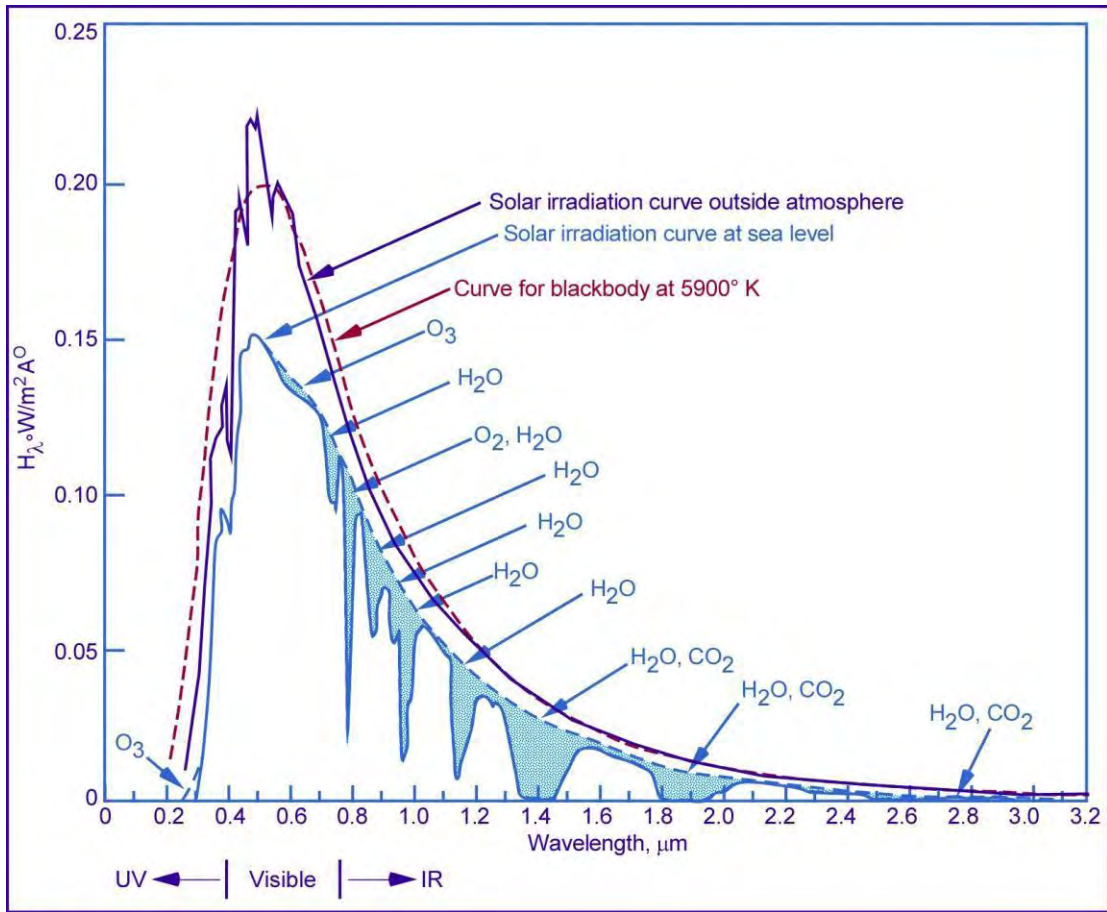


Figure 6.9-2 Spectral distribution curves for solar optical radiation (Thompson, 1986).

Solar Flares – Optical and radio frequency radiation is acutely emitted by the Sun during solar flares. This electromagnetic radiation may be emitted by smaller flares that do not produce solar cosmic rays. The varied frequencies of RF radiation are generated at different altitudes in the solar atmosphere (e.g., microwave bursts are produced in the lower part of the corona). Solar flux units (sfu) are $10^{-22} \text{ W} \cdot \text{m}^{-2} \cdot \text{Hz}$, and a peak may produce up to 105 sfu. These radio frequency bursts are not a problem in terms of direct biological effects on space travelers, but may affect them indirectly through interference with onboard electrical equipment, including communications and other instrumentation. The very minor fluctuations in the intensity of visible and UV radiation during solar flares should be considered part of continuous solar emissions.

Magnetic Fields – Magnetic fields associated with various objects in the solar system vary over many orders of magnitude. Magnetic fields a thousand times that of Earth's are found at the center of sunspots, although the magnetic field on the undisturbed surface of the Sun is 1% of that of a sunspot. The Moon, stars, and Venus have magnetic fields between 1% and 10% of Earth's, whereas Jupiter's magnetic field is 1000 times that of Earth.

6.9.2.2 Human-Made NIR Sources

- Communication equipment (radar, radio, microwave transmitters, receivers, antennae, etc.)
- Lasers
- Lights (UV, visible, IR)
- Electrically powered equipment

6.9.3 Effects of Non-Ionizing Radiation Exposure on Humans

Non-ionizing radiation generally causes injury through heat generation. Damage from optical radiation is largely limited to the skin and eyes. Ultraviolet radiation can damage tissue by photochemically altering DNA and other molecules in affected cells, and therefore increases long-term risk for some types of cancer. Infrared lasers can produce irradiances high enough to cause both skin and eye burns. Table 6.9-2 below summarizes the effects of NIR on humans.

Table 6.9-2 Effects of NIR on Humans

	Wavelength	Frequency	Biological Effects
UVC	100 nm – 280 nm	1075 THz–3000 THz	Skin – redness, inflammation Eye – inflammation of cornea
UVB	280 nm – 315 nm	950 THz – 1075 THz	Skin – redness, inflammation, skin cancer, photosensitive skin reactions, production of vitamin D Eye – inflammation of cornea
UVA	315 nm – 400 nm	750 THz – 950 THz	Skin – redness, inflammation, skin cancer Eye – cataract
Visible Light	400 nm – 780 nm	385 THz – 750 THz	Skin – photo-aging Eye – photochemical and thermal retinal injury
IR-A	780 nm – 1.4 μm	215 THz – 385 THz	Skin – burn Eye – thermal retinal injury, thermal cataract
IR-B	1.4 μm – 3 μm	100 THz – 215 THz	Skin – burn Eye – corneal burn, cataract
IR-C	3 μm – 1 mm	300 GHz – 100 THz	Skin – heating Eye – corneal burn, cataract
Microwave	1 mm – 33 cm	1 GHz – 300 GHz	Skin – heating
Radio Frequency Radiation	33 cm – 3 km	100 kHz – 1 GHz	Skin – heating with “penetration depth” of 10 mm, raised body temperature
Low-Frequency RF	> 3 km	< 100 kHz	Accumulation of charge on body surface Disturbance of nerve and muscle responses
Static Field	infinite	0 Hz	Magnetic – vertigo, nausea Electric – charge on body surface

Adapted from Martin & Sutton, 2002.

6.9.4 Human Exposure Limits for Non-Ionizing Radiation

Non-ionizing radiation is a substantial terrestrial health and safety concern for industrial workers as well as the general public. Data from extensive research and clinical experience regarding the bioeffects of NIR is available. NASA NIR standards are directly adopted or modified from established and vetted terrestrial standards. Currently no data suggests that NIR exposure effects are different in the space flight environment, allowing this direct applicability. When modifications are made to these standards, they generally remove excessive margins of safety that are imposed on general populations, or account for time-averaging differences (i.e., remove assumptions of an 8-hour workday).

Terrestrial standards are occasionally updated to reflect the most current state of understanding of non-ionizing radiation exposure. The most current versions of terrestrial

standards must be used to provide a combination of the best protection to space flight crews and the lowest engineering and operational restrictions. This practice of using the most recent standards maximizes the current and global efforts of scientists, physicians, and policymakers, and makes possible direct application to NASA's human space flight program. Most updates to these standards are minor and have no impact on space flight hardware or operational procedures currently in use. If an update in standards causes current hardware or operational procedures to become noncompliant, a hazard analysis will determine if the hazard has become uncontrolled and changes are necessary, or whether the margin of safety has been acceptably reduced. In the second case, the updated hazard analysis should be used as justification for grandfathering the hardware or operational procedure.

6.9.4.1 Radio Frequency Limits

Crewmember exposure to RF radiation must be limited to the levels modified from the most recent version of the Institute of Electrical and Electronics Engineers (IEEE) C95.1 "Standard for Safety Levels with Respect to Human Exposure to Radio-Frequency Electromagnetic Fields, 3 kHz to 300 GHz." Although the most current version of IEEE C95.1 must be modified to be applied to space travel, for illustration purposes the 2005 version of the lower-tier limits are shown in table form as Table 6.9-3, and graphically in Figure 6.9-3 (from IEEE International Committee on Electromagnetic Safety (2005)).

Modifications must be made to the C95.1 standard to remove an excessive safety margin in the power density limit that was added in the 2005 revision of the standard. This margin was added to account for the theoretical possibility that small children could exceed the basic restriction of 0.08 W/kg for whole-body averaged specific absorption rate. For more information on this topic, see IEEE International Committee on Electromagnetic Safety (2005), 95.1-2005, p.92-93. Modified as below, these limits maintain a minimal safety factor of 50 for adults, and with the exception of averaging times are very similar to C95.1-1999.

Table 6.9-3 Lower-Tier Maximum Permissible Exposure (MPE) to Radio Frequency Electromagnetic Fields

Frequency Range (MHz)	RMS Electric Field Strength (E) ^a (V/m)	RMS Magnetic Field Strength (H) ^a (A/m)	RMS Power Density (S) E-Field, H-Field (W/m ²)	Averaging Time ^b E ² , H ² , or S (minutes)	
0.1 – 1.34	614	16.3/ <i>f_M</i>	(1,000, 100,000/ <i>f_M</i> ²) ^c	6	6
1.34 - 3	823.8/ <i>f_M</i>	16.3/ <i>f_M</i>	(1,800/ <i>f_M</i> ² , 100,000/ <i>f_M</i> ²)	<i>f_M</i> ² /0.3	6
3 - 30	823.8/ <i>f_M</i>	16.3/ <i>f_M</i>	(1,800/ <i>f_M</i> ² , 100,000/ <i>f_M</i> ²)	30	6
30 - 100	27.5	158.3/ <i>f_M</i> ^{1.668}	(2, 9,400,000/ <i>f_M</i> ^{3.336})	30	0.0636 <i>f_M</i> ^{1.337}
100 - 300	27.5	0.0729	2	30	30
300 - 5000	–	–	<i>f</i> /150	30	
5000 - 15000	–	–	<i>f</i> /150	150/ <i>f_G</i>	
15000 – 30,000	–	–	100	150/ <i>f_G</i>	
30,000 – 100,000	–	–	100	25.24/ <i>f_G</i> ^{0.476}	
100,000 – 300,000	–	–	100	5048/[(9 <i>f_G</i> -700) <i>f_G</i> ^{0.476}]	

From IEEE International Committee on Electromagnetic Safety (2005). *f_M* is the frequency in MHz, *f_G* is the frequency in GHz.

(a) For exposures that are uniform over the dimensions of the body, such as certain far-field plane-wave exposures, the exposure field strengths and power densities are compared with the MPEs in the table. For non-uniform exposures, the mean values of the exposure fields, as obtained by spatially averaging the squares of the field strengths or averaging the power densities over an area equivalent to the vertical cross section of the human body (projected area), or a smaller area depending on the frequency (for further details please see IEEE International Committee on Electromagnetic Safety (2005) notes to Table 8 and Table 9), are compared with the MPEs in the table.

(b) The left column is the averaging time for |E|², the right column is the averaging time for |H|². For frequencies greater than 400 MHz, the averaging time is for power density S.

(c) These plane-wave equivalent power density values are commonly used as a convenient comparison with MPEs at higher frequencies and are displayed on some instruments in use.

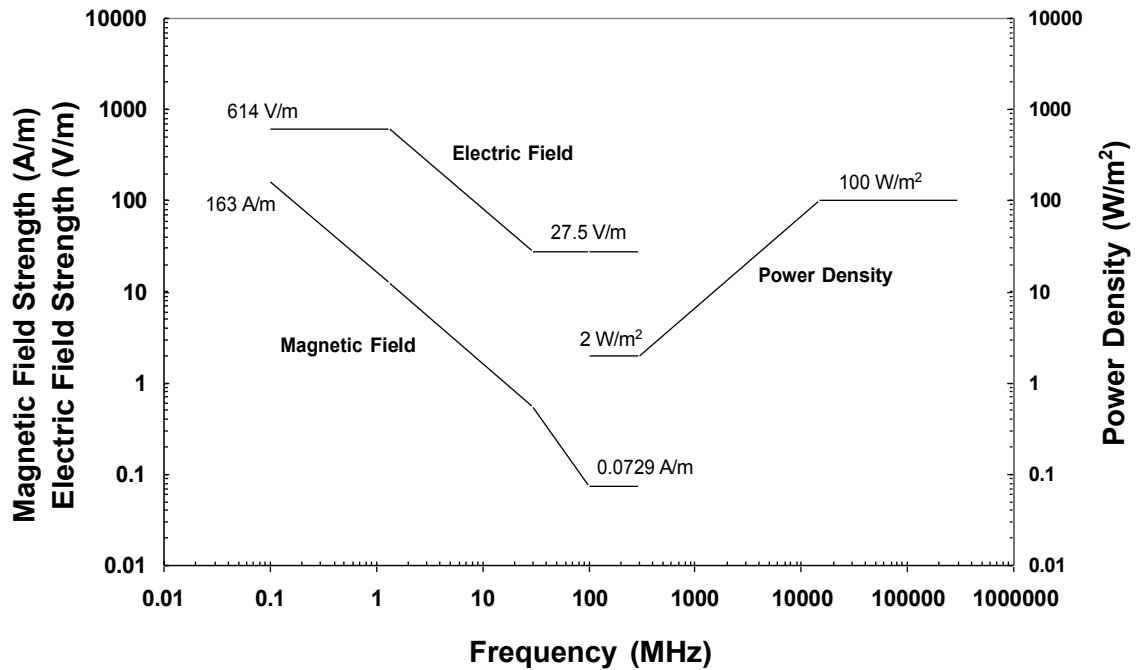


Figure 6.9-3 RF electromagnetic field exposure limits (illustrating whole-body resonance effects around 100 MHz). Modified from IEEE International Committee on Electromagnetic Safety (2005).

Two tiers of maximum permissible exposures (MPEs) are presented in IEEE C95.1. The lower tier is recommended for the general public (uncontrolled environment), which is defined as persons who live and work near RF fields of which they may not be aware or which they cannot control. This tier is also more representative of international standards for RF exposure, which are generally more stringent than those in the United States. The upper tier represents MPEs for controlled environments for which there is an established RF safety program. Both tiers have a safety margin incorporated into the limits. The population that will be inhabiting spacecraft will be aware of existing RF fields and will be highly trained, but they may also be required to live in the spacecraft environment for extended periods without the option to remove themselves from the RF field. For this reason, as well as closer synchronization with international standards, the lower tier in the most recent version of IEEE C95.1 must be met.

In addition to primary RF effects such as tissue heating, secondary hazards should be considered. These secondary effects may include induced currents and charge buildup on surfaces that could introduce a shock hazard. Shock hazards are discussed in section 9.12, “Safety Hazards.”

6.9.4.2 Coherent Radiation – Lasers

Lasers have properties that differ from those of conventional light sources; they are monochromatic (defined and limited wavelength), directional, and coherent. The amount of damage a laser can cause depends on several factors including power density, wavelength, and time of exposure. Lasers are divided into the following classes on the basis of the accessible emission limits (AEL) for each class, which is directly related to their capacity to cause injury.

- Class 1 lasers have relatively low power, and under most conditions, including optically aided conditions, do not present a hazard. This class has the lowest AEL.
- Class 1M lasers have the same AEL as Class 1, but when viewed with optical magnification these lasers can exceed the Class 1 AEL. Class 1M lasers cannot exceed the Class 3B AEL for optically aided viewing.
- Class 2 lasers also have low power, but exceed the emission limits allowed by Class 1. Class 2 lasers by definition emit visible light and cannot cause eye injury in the time required for the natural aversion response of the human eye (0.25 seconds) during unaided or optically aided viewing.
- Class 2M lasers by definition emit visible light and cannot cause eye injury in the time required for the natural aversion response of the human eye (0.25 seconds) during optically aided viewing. Class 2M lasers have the same AEL as Class 2, but when viewed with optical magnification Class 2M lasers can exceed the Class 2 AEL. Class 2M lasers cannot exceed the Class 3B AEL for optically aided viewing.
- Class 3R lasers are those that are not Class 1 or Class 2 and are within the wavelength range of $0.3025\text{--}10^3\ \mu\text{m}$, but cannot emit more than 5 times the AEL of the Class 2 AEL for visible light ($0.4\text{--}0.7\ \mu\text{m}$), and not more than 5 times the AEL of the Class 1 AEL for all other wavelengths. The aversion response does not protect against eye injury for all Class 3R lasers.
- Class 3B lasers are those that are not Class 1, 2, or 3R and effectively emit less than 500 mW for 0.25 seconds; for pulsed systems there is also a limitation in energy per pulse, based on the wavelength. These lasers can produce a hazard if viewed directly, including intrabeam viewing of specular (directed) reflections. Normally Class 3B lasers will not produce a hazardous diffuse reflection from a matte target.
- Class 4 lasers are high-power systems that are not Class 1, 2, or 3. There is no upper limit for Class 4 laser emissions. These lasers not only can produce a hazard from direct or specular reflections, but may also produce hazardous diffuse reflections. Such lasers may produce significant skin hazards as well as fire hazards.

For more information on laser classification, please see the Laser Institute of America's publication ANSI Z136.4, "American National Standard Recommended Practice for Laser Safety Measurements for Hazard Evaluations."

Application of lasers during space operations has created a variety of unique situations that require creative and extensive analysis beyond that of typical ground-based laser hazards. Consider the following factors when determining the safe use of lasers:

- Applicable procedural constraints: Space operations may require unusual situations in which lasers are used. All operational procedures need to be evaluated for the occurrence of hazardous conditions whenever laser systems are powered on. Other constraints of the space environment (such as no-fly zones and lack of window exposure) may provide the necessary protection from laser exposure.
- Failure modes: All failure modes of any laser system should be considered in detail, particularly for scanning systems that have the potential to freeze at any one position, which would cause the unintentional focusing of energy on one area for an extended period.
- Concomitant use of magnifying optical instruments: The use of direct-viewing cameras, binoculars, or other optics can greatly increase the risk of injury while lasers are in operation. Overall focusing or magnification by these instruments should be considered. Attenuation by the glass and coatings of lenses and eyepieces, as well as other optical instrument internals, should be considered during the safety analysis.
- Spatial relationships: The relative movement of spacecraft on which lasers are mounted makes it necessary to consider variable spatial relationships. Lasers are considered either a point source or an extended source, depending on the position of the viewer. Scanning angles that change with position as well as beam divergence should be considered.
- Classification: Laser systems must be properly classified and characterized per ANSI Z136.4. Commercial off-the-shelf lasers may be used in space laser systems, but if the laser is modified in any way it must be reclassified and recharacterized for its intended operational use.
- Attenuation by spacecraft windows and pressure suit helmets and visors should be considered in the safety analysis.
- Specular and diffuse reflections should be considered for all laser systems.
- Secondary effects: Safety analysis should include the effects of laser illumination of the crew beyond actual injury. These should include startle and afterimage effects during mission-critical or safety-critical activities.
- Integration: Safety analyses of laser systems should be jointly performed by laser system experts, laser safety experts, any optical system experts, and Flight Operations, particularly experts in operation of photographic or other optical devices.

6.9.4.2.1 Limits for Ocular Exposure to Lasers

Ocular exposure of the crew to laser systems must remain below the limits specified in the most recent version of Laser Institute of America's publication "American National Standard for Safe Use of Lasers" (ANSI Z136.1) without the use of PPE.

Although the most current version of ANSI Z136.1 must be applied, for illustration purposes, the 2007 version of the maximum permissible exposures are shown in Tables 6.9-4 and 6.9-5. The methodology presented in ANSI Z136.1 must be applied to accurately assess laser exposure. Notes in the tables refer to tables and sections in ANSI Z136.1 2007.

Table 6.9-4 Maximum Permissible Exposure (MPE) for Point Source Ocular Exposure to a Laser Beam (ANSI Z136.1 2007)

Wavelength (μm)	Exposure Duration, t (s)	MPE		Notes
		($\text{J}\cdot\text{cm}^{-2}$)	($\text{W}\cdot\text{cm}^{-2}$)	
Ultraviolet <i>Dual Limits for λ between 0.180 and 0.400 μm</i>				In the Dual Limit Wavelength Region (0.180 to 0.400 μm), the lower MPE considering photochemical and thermal effects must be chosen. See Tables 8a and 8b for limiting aperture and Table 9 for measurement aperture.
Thermal				
0.180 to 0.400	10^{-9} to 10	$0.56 t^{0.25}$		
Photochemical				
0.180 to 0.302	10^{-9} to 3×10^4	3×10^{-3}		
0.302 to 0.315	10^{-9} to 3×10^4	$10^{200(\lambda-0.295)} \times 10^{-4}$		
0.315 to 0.400	10 to 3×10^4	1.0		
Visible				In the Wavelength Region (0.400 to 0.500 μm), T_1 determines whether the photochemical or thermal MPE is lower. For extended sources in the retinal hazard region (0.400 to 1.4 μm), see Table 5b. See Table 6 and Figures 8 and 9 for correction factors C_A , C_B , C_C , C_P , C_E , and times T_1 and T_2 .
0.400 to 0.700	10^{-13} to 10^{-11}	1.5×10^{-8}		
0.400 to 0.700	10^{-11} to 10^{-9}	$2.7 t^{0.75}$		
0.400 to 0.700	10^{-9} to 18×10^{-6}	5.0×10^{-7}		
0.400 to 0.700	18×10^{-6} to 10	$1.8 t^{0.75} \times 10^{-3}$		
0.500 to 0.700	10 to 3×10^4		1×10^{-3}	
Thermal				
0.450 to 0.500	10 to T_1		1×10^{-3}	
Photochemical				
0.400 to 0.450	10 to 100	1×10^{-2}		
0.450 to 0.500	T_1 to 100	$C_B \times 10^{-2}$		
0.400 to 0.500	100 to 3×10^4		$C_B \times 10^{-4}$	
Near Infrared				For repeated (pulsed) exposures, see Section 8.2.3. A correction factor, C_P applies to thermal limits, but not to photochemical limits. The wavelength region λ_1 to λ_2 means $\lambda_1 \leq \lambda < \lambda_2$, e.g., 0.180 to 0.302 μm means $0.180 \leq \lambda < 0.302 \mu\text{m}$.
0.700 to 1.050	10^{-13} to 10^{-11}	$1.5 C_A \times 10^{-8}$		
0.700 to 1.050	10^{-11} to 10^{-9}	$2.7 C_A t^{0.75}$		
0.700 to 1.050	10^{-9} to 18×10^{-6}	$5.0 C_A \times 10^{-7}$		
0.700 to 1.050	18×10^{-6} to 10	$1.8 C_A t^{0.75} \times 10^{-3}$		
0.700 to 1.050	10 to 3×10^4		$C_A \times 10^{-3}$	
1.050 to 1.400	10^{-13} to 10^{-11}	$1.5 C_C \times 10^{-7}$		
1.050 to 1.400	10^{-11} to 10^{-9}	$27.0 C_C t^{0.75}$		
1.050 to 1.400	10^{-9} to 50×10^{-6}	$5.0 C_C \times 10^{-6}$		
1.050 to 1.400	50×10^{-6} to 10	$9.0 C_C t^{0.75} \times 10^{-3}$		
1.050 to 1.400	10 to 3×10^4		$5.0 C_C \times 10^{-3}$	
Far Infrared				Note: The MPEs must be in the same units.
1.400 to 1.500	10^{-9} to 10^{-3}	0.1		
1.400 to 1.500	10^{-3} to 10	$0.56 t^{0.25}$		
1.400 to 1.500	10 to 3×10^4		0.1	
1.500 to 1.800	10^{-9} to 10	1.0		
1.500 to 1.800	10 to 3×10^4		0.1	
1.800 to 2.600	10^{-9} to 10^{-3}	0.1		
1.800 to 2.600	10^{-3} to 10	$0.56 t^{0.25}$		
1.800 to 2.600	10 to 3×10^4		0.1	
2.600 to 1000	10^{-9} to 10^{-7}	1×10^{-2}		
2.600 to 1000	10^{-7} to 10	$0.56 t^{0.25}$		
2.600 to 1000	10 to 3×10^4		0.1	

Table 6.9-5 Maximum Permissible Exposure (MPE) for Extended Source Ocular Exposure (ANSI Z136.1 2007)

Wavelength (μm)	Exposure Duration, t (s)	MPE		Notes
		($\text{J}\cdot\text{cm}^{-2}$) except as noted	($\text{W}\cdot\text{cm}^{-2}$) except as noted	
Visible				
0.400 to 0.700	10^{-13} to 10^{-11}	$1.5 C_E \times 10^{-8}$		(See Tables 8a and 9 for limiting apertures)
0.400 to 0.700	10^{-11} to 10^{-9}	$2.7 C_E t^{0.75}$		
0.400 to 0.700	10^{-9} to 18×10^{-6}	$5.0 C_E \times 10^{-7}$		
0.400 to 0.700	18×10^{-6} to 0.7	$1.8 C_E t^{0.75} \times 10^{-3}$		
<i>Dual Limits for λ between 0.400 and 0.600 μm visible laser exposure for $t > 0.7$ s</i>				
Photochemical				
For $\alpha \leq 11\text{mrad}$, the MPE is expressed as irradiance and radiant exposure*				
0.400 to 0.600	0.7 to 100	$C_B \times 10^{-2}$		(See Tables 8a and 9 for limiting apertures)
0.400 to 0.600	100 to 3×10^4		$C_B \times 10^{-4}$	
For $\alpha > 11\text{mrad}$, the MPE is expressed as radiance and integrated radiance*				
0.400 to 0.600	0.7 to 1×10^4	$100 C_B \text{ J}\cdot\text{cm}^{-2}\cdot\text{sr}^{-1}$		(See Table 8a for limiting cone angle γ)
0.400 to 0.600	1×10^4 to 3×10^4		$C_B \times 10^{-2} \text{ W}\cdot\text{cm}^{-2}\cdot\text{sr}^{-1}$	
<i>and</i>				
Thermal				
0.400 to 0.700	0.7 to T_2	$1.8 C_E t^{0.75} \times 10^{-3}$		
0.400 to 0.700	T_2 to 3×10^4		$1.8 C_E T_2^{-0.25} \times 10^{-3}$	
Near Infrared				
0.700 to 1.050	10^{-13} to 10^{-11}	$1.5 C_A C_E \times 10^{-8}$		(See Tables 8a and 9 for limiting apertures)
0.700 to 1.050	10^{-11} to 10^{-9}	$2.7 C_A C_E t^{0.75}$		
0.700 to 1.050	10^{-9} to 18×10^{-6}	$5.0 C_A C_E \times 10^{-7}$		
0.700 to 1.050	18×10^{-6} to T_2	$1.8 C_A C_E t^{0.75} \times 10^{-3}$		
0.700 to 1.050	T_2 to 3×10^4		$1.8 C_A C_E T_2^{-0.25} \times 10^{-3}$	
0.700 to 1.050	10^{-13} to 10^{-11}	$1.5 C_C C_E \times 10^{-7}$		
1.050 to 1.400	10^{-11} to 10^{-9}	$27.0 C_C C_E t^{0.75}$		
1.050 to 1.400	10^{-9} to 50×10^{-6}	$5.0 C_C C_E \times 10^{-6}$		
1.050 to 1.400	50×10^{-6} to T_2	$9.0 C_C C_E t^{0.75} \times 10^{-3}$		
1.050 to 1.400	T_2 to 3×10^4		$9.0 C_C C_E T_2^{-0.25} \times 10^{-3}$	
<p>† See Table 6 and Figures 8, 9 and 13 for correction factors C_A, C_B, C_C, C_E, C_P, and times T_1 and T_2.</p> <p>* For sources subtending an angle greater than 11 mrad, the limit may also be expressed as an integrated radiance $L_p = 100 C_B \text{ J}\cdot\text{cm}^{-2}\cdot\text{sr}^{-1}$ for $0.7 \text{ s} \leq t < 10^4 \text{ s}$ and $L_e = C_B \times 10^{-2} \text{ W}\cdot\text{cm}^{-2}\cdot\text{sr}^{-1}$ for $t \geq 10^4 \text{ s}$ as measured through a limiting cone angle γ. These correspond to values of $\text{J}\cdot\text{cm}^{-2}$ for $10 \text{ s} \leq t < 100 \text{ s}$ and $\text{W}\cdot\text{cm}^{-2}$ for $t \geq 100 \text{ s}$ as measured through a limiting cone angle γ.</p> <p>$\gamma = 11 \text{ mrad}$ for $0.7 \text{ s} \leq t < 100 \text{ s}$, $\gamma = 1.1 \times t^{0.5} \text{ mrad}$ for $100 \text{ s} \leq t < 10^4 \text{ s}$ $\gamma = 110 \text{ mrad}$ for $10^4 \text{ s} \leq t < 3 \times 10^4 \text{ s}$</p> <p>See Figure 3 for γ and Appendix B7.2 for examples.</p> <p>Note 1: For repeated (pulsed) exposures, see Section 8.2.3.</p> <p>Note 2: The wavelength region λ_1 to λ_2 means $\lambda_1 \leq \lambda < \lambda_2$, e.g., 1.180 to 1.302 μm means $1.180 \leq \lambda < 1.302 \mu\text{m}$.</p> <p>Note 3: Dual Limit Application: In the Dual Limit wavelength region (0.400 to 0.600 μm), the exposure limit is the lower value of the determined photochemical and thermal exposure limit.</p> <p>Note 4: The MPEs must be in the same units.</p>				

These limits protect against eye injury from ocular exposure to both continuous and repetitively pulsed lasers. The term “laser system” includes the laser, its housing, and its controls. The safety analysis of all lasers is defined by ANSI Z136.1 standards.

The Trajectory Control Sensor used on the Space Shuttle for docking operations uses Class 3B lasers, in both continuous wave and pulsed wave modes. The Laser Camera System used on the Orbiter Boom Sensor System is also a Class 3B laser. The Laser Dynamic Range Imager contains a Class 4 laser source, but the diffuser that is integral to the system effectively reduces the emissions to those of a Class 1 system.

6.9.4.2.2 Limits for Dermal Exposure to Lasers

Dermal exposure of the crew to laser systems must remain below the limits specified in the most recent version of Laser Institute of America’s publication “American National Standard for Safe Use of Lasers” (ANSI Z136.1) without the use of PPE. Although the most current version of ANSI Z136.1 must be applied, for illustration purposes the 2007 version of the maximum permissible exposures for skin are shown in Table 6.9-6. The methodology presented in ANSI Z136.1 must be applied to accurately assess laser exposure. Notes in the tables refer to tables and sections in ANSI Z136.1 2007.

Table 6.9-6 Maximum Permissible Exposure (MPE) for Skin Exposure to a Laser Beam

Wavelength (μm)	Exposure Duration, t (s)	MPE		Notes
		($\text{J}\cdot\text{cm}^{-2}$) except as noted	($\text{W}\cdot\text{cm}^{-2}$) except as noted	
Ultraviolet				In the Dual Limit Wavelength Region (0.180 to 0.400 μm), the lower MPE considering photochemical and thermal effects must be chosen. 3.5 mm limiting aperture applies for all wavelengths and exposure durations (see Table 8a).
<i>Dual Limits for λ between 0.180 to 0.400 μm</i>				
Thermal 0.180 to 0.400	10^{-9} to 10	$0.56 t^{0.25}$		
Photochemical 0.180 to 0.302	10^{-9} to 3×10^4	3×10^{-3}		
0.302 to 0.315	10^{-9} to 3×10^4	$10^{200(\lambda-0.295)} \times 10^{-4}$		
0.315 to 0.400	10 to 10^3	1.0	1×10^{-3}	
0.315 to 0.400	10^3 to 3×10^4			
Visible and Near Infrared				The wavelength region λ_1 to λ_2 means $\lambda_1 \leq \lambda < \lambda_2$, e.g., 0.180 to 0.302 μm means $0.180 \leq \lambda < 0.302 \mu\text{m}$.
0.400 to 1.400	10^{-9} to 10^{-7}	$2 C_A \times 10^{-2}$		
0.400 to 1.400	10^{-7} to 10	$1.1 C_A t^{0.25}$	$0.2 C_A$	
0.400 to 1.400	10 to 3×10^4			
Far Infrared				The exposure duration t_1 to t_2 means $t_1 \leq t < t_2$, e.g., 10 to 10^3 s means $10 \text{ s} \leq t < 10^3 \text{ s}$. See Section 8.4.2 for large beam cross sections and Table 6 for correction factor C_A
1.400 to 1.500	10^{-9} to 10^{-3}	0.1		
1.400 to 1.500	10^{-3} to 10	$0.56 t^{0.25}$		
1.400 to 1.500	10 to 3×10^4		0.1	
1.500 to 1.800	10^{-9} to 10	1.0		
1.500 to 1.800	10 to 3×10^4		0.1	
1.800 to 2.600	10^{-9} to 10^{-3}	0.1		
1.800 to 2.600	10^{-3} to 10	$0.56 t^{0.25}$		
1.800 to 2.600	10 to 3×10^4		0.1	
2.600 to 1000	10^{-9} to 10^{-7}	1×10^{-2}		
2.600 to 1000	10^{-7} to 10	$0.56 t^{0.25}$		
2.600 to 1000	10 to 3×10^4		0.1	

From ANSI Z136.1 2007.

These limits protect against skin injury from both continuous and repetitively pulsed lasers. The term “laser system” includes the laser, its housing, and controls. The safety analysis of all lasers must be defined by ANSI Z136.1 standards.

6.9.4.3 Incoherent Radiation – UV, Visible, and IR

Limits for crew exposure to the electromagnetic spectrum from the ultraviolet (180 nm) to the far infrared (3000 nm) are derived from the methodology given in the American Conference of Governmental Industrial Hygienists (ACGIH) publication “TLVs® and BEIs® Based on the Documentation of the Threshold Limit Values for Chemical Substances and Physical Agents & Biological Exposure Indices.” This methodology allows the quantification of the relationship between source strength and acceptable exposure times for each of four potential injury pathways (retinal thermal injury caused by exposure to visible light, retinal photochemical injury caused by chronic exposure to

blue light, thermal injury to the ocular lens and cornea caused by infrared exposure, and exposure of the unprotected skin or eye to ultraviolet radiation). These limits do not apply to laser exposure (see section 6.9.4.2, “Coherent Radiation – Lasers”). The numerical values used by the ACGIH are amended for use by NASA by the insertion of a factor of 0.2 in the source term of each calculation, except that the calculation for ultraviolet exposure is not amended. This removes the excessive margin of safety imposed by the ACGIH on general populations.

Any exposure to NIR should consider the entire pathway of the incident radiation before it interacts with a crewmember’s body, including any concentration, diffusion, or filtering. For example, concentration of source radiation by optical instruments and attenuation by spacecraft window systems or EVA visors need to be considered when evaluating the final radiation incident on the crewmember. Protection from NIR may be accomplished by reducing effective irradiance or by limiting exposure times. Any means of providing NIR protection must not permanently degrade the ability of any optical systems to perform their intended function. The transmittance required for windows, visors, and other optical devices can be reconciled with protection from NIR through the use of temporary filters, selection of proper material, apertures, beam stops or splitters, or other appropriate means.

Different limits are set for large and small sources for retinal damage pathways. Large sources illuminate large areas of the retina and this does not allow local cooling or cellular recovery. Small sources illuminate a much smaller area of the retina, and the natural movement of the eye constantly alters the area that is being illuminated, effectively reducing exposure. For this reason, the exposure limits for small sources are relaxed.

6.9.4.3.1 Limits for Retinal Thermal Injury from Visible and Near-Infrared Sources

Exposure of the crew to spectral radiance L_λ at wavelengths between 385 and 1400 nm must be limited such that

$$0.2 \sum_{385}^{1400} \{ L_\lambda R(\lambda) \Delta\lambda \} \leq \frac{5}{\alpha t^{1/4}}$$

where L_λ is the source spectral radiance in W/(cm²•sr•nm), $R(\lambda)$ is the Retinal Thermal Hazard Function given in the current version of “TLVs[®] and BEIs[®] Based on the Documentation of the Threshold Limit Values for Chemical Substances and Physical Agents & Biological Exposure Indices,” t is the viewing duration in seconds, and α is the angular subtense of the source in radians. This limit is intended to prevent retinal thermal injury from visible and near-infrared sources with wavelengths between 385 and 1400 nm.

6.9.4.3.2 Retinal Photochemical Injury from Visible Light

6.9.4.3.2.1 Small-Source Visible Radiation Limits

The spectral irradiance E_λ of the crew at wavelengths between 305 and 700 nm for visible light sources subtending an angle less than 11 milliradians must be limited such that:

$$0.2 \sum_{305}^{700} \{E_\lambda t B(\lambda) \Delta\lambda\} \leq 10 \text{ mJ/cm}^2 \quad \text{for } t < 10^4 \text{ s}$$

Or,

$$0.2 \sum_{305}^{700} \{E_\lambda B(\lambda) \Delta\lambda\} \leq 1 \text{ } \mu\text{W/cm}^2 \quad \text{for } t > 10^4 \text{ s}$$

where $B(\lambda)$ is the blue-light hazard function given in the current version of “TLVs® and BEIs® Based on the Documentation of the Threshold Limit Values for Chemical Substances and Physical Agents & Biological Exposure Indices” and t is the viewing duration in seconds. This limit is intended to prevent retinal photochemical injury from exposure to light sources with wavelengths between 305 and 700 nm. The Sun subtends an angle of approximately 9 milliradians when observed from Earth and is therefore considered a small source.

6.9.4.3.2.2 Large-Source Visible Radiation Limits

Exposure of the crew to spectral radiance L_λ at wavelengths between 305 and 700 nm for visible light sources subtending an angle greater than or equal to 11 milliradians must be limited such that

$$0.2 \sum_{305}^{700} \{L_\lambda t B(\lambda) \Delta\lambda\} \leq 100 \text{ J/(cm}^2 \cdot \text{sr)} \quad \text{for } t \leq 10^4 \text{ s}$$

or

$$0.2 \sum_{305}^{700} \{L_\lambda B(\lambda) \Delta\lambda\} \leq 10^{-2} \text{ W/(cm}^2 \cdot \text{sr)} \quad \text{for } t > 10^4 \text{ s}$$

where $B(\lambda)$ is the blue-light hazard function given in the current version of “TLVs® and BEIs® Based on the Documentation of the Threshold Limit Values for Chemical Substances and Physical Agents & Biological Exposure Indices,” and t is the viewing duration in seconds. This limit is intended to prevent retinal photochemical injury from exposure to large light sources with wavelengths between 305 and 700 nm.

6.9.4.3.3 Limits for Thermal Injury from Infrared Radiation

The spectral irradiance E_λ of the crew at wavelengths between 770 and 3000 nm must be limited to 10 mW/cm² for exposure durations longer than 1000 seconds, and for exposure durations less than 1000 seconds exposure must be limited such that

$$0.2 \sum_{770}^{3000} \{E_{\lambda} \Delta \lambda\} \leq 1.8 t^{-3/4} \quad W/cm^2$$

where t is the viewing duration in seconds. This limit is intended to prevent ocular injury caused by overexposure to infrared radiation, including delayed effects to the lens (such as cataractogenesis). These TLVs apply to an environment with an ambient temperature of 37°C, and can be increased by 0.8 mW/cm² for every whole degree below 37°C.

6.9.4.3.4 Limits for Ultraviolet Exposure for Unprotected Eye or Skin

The spectral irradiance E_{λ} of the crew at wavelengths between 180 and 400 nm, weighted by the spectral effectiveness function S_{λ} (given in the current version of “TLVs® and BEIs® Based on the Documentation of the Threshold Limit Values for Chemical Substances and Physical Agents & Biological Exposure Indices”), must be limited to

$$\sum_{180}^{400} \{E_{\lambda} S_{\lambda} t \Delta \lambda\} \leq 3 \text{ mJ/cm}^2 \quad \text{in any 24 hr period}$$

where t is the exposure duration in seconds. This limit is intended to prevent ocular and dermal injury caused by overexposure to ultraviolet radiation.

6.9.5 Hazard Controls for Non-Ionizing Radiation Effects

Hazard controls for overexposure to NIR depend on the type and source of the NIR and mission requirements. The control of NIR hazards can be by engineering or operational, or a combination of both types of controls. Table 6.9-7 defines the sources and associated hazard control methods.

Table 6.9-7 Non-Ionizing Radiation Hazard Control Methods

Radiation Source	Hazard Controls
RF	Full characterization and limitation of RF environment in and surrounding spacecraft, training, labels, operational procedures that limit exposure
Lasers	Beam stops and attenuators, enclosed beam paths, removable filters, filtered eyepieces on optical instruments, training, labels, operational procedures
Incoherent	Removable filters, filtered eyepieces on optical instruments, labels, controlling reflections, clothing, pressure suit (UV), operational procedures that limit exposure time

The use of PPE must be provided only if other methods of controlling the hazard are impossible or highly impractical. PPE is typically uncomfortable and has negative effects on performance, leading to noncompliance. For example, laser-protective eyewear cannot be worn while performing high-resolution photography with direct-view cameras. In the best scenarios, the field of view and color vision may be affected.

Monitoring and warning for NIR during space operations may include activities such as

- Warning lights or annunciations before emission of NIR (lasers, powerful incoherent light sources, RF emitters)
- Monitoring and warning of approaching sunrise (incoherent light)
- Monitoring of RF fields in and surrounding the spacecraft

Protection from excessive NIR exposure may require creative solutions given that the use of many forms of NIR is essential to the accomplishment of mission objectives. For example, if an operational scenario requires the use of an IR laser from within the spacecraft, permanent window coatings that block IR would not be appropriate. Similarly, if observation activities require the use of UV wavelengths, permanent UV filters would not be a suitable solution. For both photography and psychological benefit, the color balance of natural light entering through spacecraft windows must be preserved. Any means of protecting the crew from excessive exposure to NIR must never permanently degrade the performance or preclude the use of space flight equipment to which it is applied.

6.9.6 Research Needs

NASA has no specific research needs related to NIR bioeffects because extensive work is being done for general industry and populations. Substantial work, however, remains to be done in the area of implementation in the unique space flight environment. This is made particularly challenging by requirements that initially seem contradictory (for example, window systems that must meet high optical quality and transmission specifications while still providing protection from NIR to the crew).

6.10 REFERENCES

- Adelstein, B.D., Beutter, B.R., Kaiser, M.K., McCann, R.S., & Stone, L.S. (2009a). *Effects of Transverse Seat Vibration on Near-Viewing Readability of Alphanumeric Symbology*. NASA/TM 2009-215385.
- Adelstein, B.D., Beutter, B.R., Kaiser, M.K., McCann, R.S., Stone, L.S., Anderson, M.R., Renema, F., & Paloski, W.H (2009b). *Influence of Combined Whole-Body Vibration Plus G-Loading on Visual Performance*. NASA/TM 2009-2153.
- Adelstein, B.D., Kaiser, M.K., Beutter, B.R., McCann, & Anderson, M.R. (2012). Display strobing: an effective countermeasure against visual blur from whole-body vibration. *Acta Astronautica*, (In Press). DOI:10.1016/j.actaastro.2012.07.003.
- Adelstein, B.D., Beutter, B.R., Kaiser, M.K., McCann, R.S., Stone, L.S., Holden, K.L., & Root, P.J. (2012, in preparation) et al. *Determining Subjective Thresholds for Display Usability Under Combined Whole-Body Vibration Plus G-Loading*. NASA/TM in preparation. [SHFE DRP 2008 final report not publicly available.]
- Albery, W.B. & Chelette, T.L. (1998). Effect of G Suit Type on Cognitive Performance. *Aviat Space Environ Med*, 69(5), 474–9.
- Allen, C.S. & Denham, S.A. (2011). International Space Station Acoustics, A Status Report, *Proceedings of International Conference on Environmental Systems, AIAA 2011-5128*.
- American Bureau of Shipping (ABS) (2003). *Guide for Crew Habitability on Ships*, American Bureau of Shipping, Houston TX.
- American Conference of Governmental Industrial Hygienists (ACGIH) Current Version. TLVs[®] and BEIs[®] Based on the Documentation of the Threshold Limit Values for Chemical Substances and Physical Agents & Biological Exposure Indices. ACGIH, Cincinnati, OH.
- American Conference of Governmental Industrial Hygienists (ACGIH) (2001). Threshold Level Values (TLVs), Infrasound and Low-Frequency Sound, 2001. ACGIH, Cincinnati, OH.
- American Conference of Government Industrial Hygienists (ACGIH), Threshold Limit Values & Biological Exposure Indices (BIEs), 2004.
- ANSI (2006). *Guide for the Measurement and Evaluation of Human Exposure to Vibration Transmitted to the Hand*. American National Standard S2.70-2006. American National Standards Institute.
- ANSI S1.1-1994, *Acoustical Terminology*, 1994. American National Standards Institute, New York, NY.
- ANSI/ASA S12.2-2008. American National Standards Institute, American National Criteria for Evaluating Room Noise, New York, NY.

ANSI S12.65-2006, American National Standards Institute, American National Standard for Rating Noise with Respect to Speech Interference, New York, NY.

ANSI Z136.1, American National Standards Institute, Current Version. American National Standard for Safe Use of Lasers. American National Standards Institute, New York, NY.

ANSI Z136.4, American National Standards Institute, Current Version. American National Standard Recommended Practice for Laser Safety Measurements for Hazard Evaluations. American National Standards Institute, New York, NY.

ANSI Z90, American National Standards Institute, American National Standard Specification for Protective Headgear for Vehicular Users, American National Standards Institute, New York, NY.

Anton, D.J. (1986) *The Incidence of Spinal Fracture on Royal Air Force Ejections 1968-1983*. (Aircrew Equipment Group Report No. 529). RAF Institute of Aviation Medicine Aircrew Equipment Group.

Armstrong, T.W. & Colborn, B.L. (2000). Evaluation of Trapped Radiation Model Uncertainties for Spacecraft Design. Technical Report, NASA/CR-2000-210072; NAS 1.26:210072; M-970.

Armstrong, T.W. & Colborn, B.L. (1991). Cosmic Ray and Secondary Particle Environment Analysis for Large Lunar Telescope Instruments. Science Applications International Corporation Report SAIC-TN-912.

Association for the Advancement of Automotive Medicine. (2005). Abbreviated Injury Scale 2005. Barrington, IL. Balldin, U.I., O'Connor, R.R., Werchan, P.M., Isdahl, W.M., Demitry, P.F., Stork, R.L., & Morgan, T.R. (2002). Heat Stress Effects for USAF Anti-g Suits with and without a Counter-pressure Vest. *Aviat Space Environ Med*, 73(5), 456–9.

Badhwar, G.D. & O'Neill, P.M. (1991). An improved model of galactic cosmic radiation for space exploration missions. In *Proceedings of the 22nd International Cosmic Ray Conference*, (Dublin, OG-5.2-13. pp. 643–646). Dublin, Ireland: Elsevier Ltd.

Badhwar, G.D., Keith, J.E., & Cleghorn, T.F. (2001). Neutron measurements onboard the space shuttle. *Radiation Measurements*, 33(3), 235–241.

Bailey, J.V. (1976). Dosimetry during Space Missions. 1976. *IEEE Transactions on Nuclear Science*. 23 (4).

Balldin, U.I., O'Connor, R.B., Isdahl, W.M., & Werchan, P.M. (2005). Pressure Breathing without a Counter-pressure Vest does not Impair Acceleration Tolerance up to 9 G. *Aviat Space Environ Med*, 76(5), 456–62.

Balldin, U.I., O'Connor, R.R., Werchan, P.M., Isdahl, W.M., Demitry, P.F., Stork, R.L., & Morgan, T.R. (2002). Heat Stress Effects for USAF Anti-g Suits with and without a Counter-pressure Vest. *Aviat Space Environ Med*, 73(5), 456–9.

Begault, D.R. (2011). Effect of whole-body vibration on speech, part II: effect on intelligibility. *Audio Engineering Society 131st Convention*, New York, paper no. 8582.

- Beranek, L.L. & Ver, I.L. (1992). *Noise and Vibration Control Engineering, Principals and Applications*. Wiley-Science, New York., NY.
- Berger, E.H., et al. (2003). *The Noise Manual* (5th ed.), AIHA Press, Fairfax, VA.
- Boff, E.R., & Lincoln, J.E. (1988). Vibration (Section 10.4), in *Engineering Data Compendium: Human Perception and Performance*. Armstrong Aerospace Medical research Laboratory, Wright-Patterson AFB, pp. 2064-2136.
- Bogatova, R.I., Allen, C.S., Kutina, I.V., & Goodman, J.R. (2008). *The Habitable Environment of the ISS, Section 1, Microclimate, Acoustic Environment, and Lighting Conditions*. (incomplete reference)
- Brauer, R.L. (2006). *Safety and Health for Engineers, 2nd Edition*. Hoboken, NJ: Wiley.
- Brinkley, J.W. & Raddin, J.H. (2002). Transient Acceleration. In R. L. DeHart & J. R. Davis (Eds.), *Fundamentals of Aerospace Medicine*. New York, NY: Lippincott, Williams, & Wilkins.
- Brinkley, J.W., Specker, L.S., & Mosher, S. E., (1990). *Development of Acceleration Exposure Limits for Advanced Escape Systems*, In *Implications of Advanced Technologies for Air and Spacecraft Escape*, (NATO Advisory Group for Aerospace Research and Development Proceedings AGARD-CP-472).
- Brinkley, J.W. (1985). Acceleration Exposure Limits for Escape System Advanced Development, *SAFE Journal*, Vol. 15(2), 10-16.
- Bruce, R.J., Ott, C.M., et al. (2005). Microbial surveillance of potable water sources of the International Space Station. 35th International Conference on Environmental Systems, Rome, Italy.
- Buhrman, J.R., Perry, C.E., & Mosher, S.E. (2000). *A Comparison of Male and Female Acceleration Responses During Laboratory Frontal -Gx Axis Impact Tests*. (AFRL-HE-WP-TR-2001-0022). Wright-Patterson Air Force Base, OH: Air Force Research Laboratory.
- Bungo, M.W., Charles, J.B., & Johnson, P.C. Jr. (1985) Cardiovascular Deconditioning During Space Flight and the Use of Saline as a Countermeasure to Orthostatic Intolerance. *Aviat Space Environ Med*, 56(10), 985-90.
- Bureau of Transportation Statistics. (2007). Trends in Personal Income and Passenger Vehicle Miles. SR-006, U.S. Department of Transportation, Research and Innovative Technology Administration, Washington, D.C.
- Butler, J. (TBD). *The Psychological Effects of Noise: Recommendations for ISS*. Unpublished white paper, Columbia University, College of Physicians and Surgeons, New York, NY. (incomplete reference)
- Cable, J. 2004. NIOSH report details dangers of carbon dioxide in confined spaces. Occupational Hazards, 12/30/2004.
- Campbell, P.D. (1992). Crew Habitable Element Space Radiation Shielding for Exploration Missions. LESC-30455, prepared for Flight Crew Support Division, Johnson Space Center. (incomplete reference)

- Carleon, W.M. & Welch, B.E. (1971). *Fluid balance in artificial environments: role of environmental variables* (NASA CR-114977). Brooks Air Force Base, TX: School of Aerospace Medicine.
- CHABA (Committee on Hearing, Bioacoustics, and Biomechanics) (1987). Guidelines for Noise and Vibration levels for the Space Station, Report Number: NAS 1.26:178310; NASA-CR-178310.
- Charles, J.B. & Lathers, C.M. (1991) Cardiovascular adaptation to spaceflight. *J. Clin. Pharmacol*, v. 31, p. 1010 -1023, 1991.
- Chu, S.R., & Allen C.S. (2011). Spacecraft Cabin Acoustic Modeling and Validation with Mockups, *Proceedings of International Conference on Environmental Systems, AIAA 2011-5112*.
- Clark, J.B. & Allen, C.S. (2008). Acoustics Issues, In *Principles of Clinical Medicine for Space Flight*, 24, New York, NY, Springer.
- Clarke, N.P., Taub, H., Scherer, H.F., Temple, W.E., Vykukal, H.C., & Matter, M. (1965). *Preliminary Study of Dial reading Performance During Sustained Acceleration and Vibration*. Aerospace Medical Research Laboratories, Wright Patterson AFB, AMRL-TR-65-110.
- Craske, B. (1977) Perception of impossible limb positions induced by tendon vibration. *Science*, 196 (4285), 71-73.
- Crocker, M.J. (1989). *Handbook of Acoustics*, Chapter 23, 24, and 25. New York, NY. John Wiley and Sons Inc.
- Cucinotta, F.A., Manuel, F. K., Jones, J., Iszard, G., Murrey, J., Djojonegro, B., & Wear, M. (2001). Space radiation and cataracts in astronauts. *Radiat Res*, 156, 460–466.
- Cucinotta, F.A., Kim, M.Y., & Ren, L. (2005). Managing Lunar and Mars Mission Radiation Risks Part I: Cancer Risks, Uncertainties, and Shielding Effectiveness (NASA-TP-2005213164). Houston, TX: National Aeronautics and Space Administration.
- Cucinotta, F.A., Schimmerling, W., Wilson, J.W., Peterson, L.E., Saganti, P., Badhwar, G.D., & Dicello, J.F. (2001). Space Radiation Cancer Risks and Uncertainties for Mars Missions. *Radiat Res*, 156, 682–688.
- Cucinotta, F.A., Shavers, M.R., Saganti, P. B., Miller, J. (Eds.). (2003). Radiation Protection Studies of International Space Station Extravehicular Activity Space Suits, (TP-2003-212051, pp. 196). Houston, TX: National Aeronautics and Space Administration.
- Denham, S.A. & Kidd, G. (1996). *US laboratory architectural control document. Volume 14: Acoustics*. NASA D683-149-147-1-14. Houston, TX: NASA Johnson Space Center.
- Depreitere, B., Van Lierde, C., Vander Sloten, J., Van Audekercke, R., Van der Perre, G., Plets, C., & Goffin, J. (2006). Mechanics of acute subdural hematomas resulting from bridging vein rupture. *J Neurosurg*, 104(6), 950–956.

- Destafanis, S. & Marucchi-Chierro, P.C. (2002). *Node 3 audible noise/human vibration environments analysis and budget report*. Report N3-RP-AI-0014. Turino, Italy: Alenia Aerospazio, Space Division.
- Drexel, R.E. & Hunter, H.N. (1973) *Apollo Experience Report: Command Module Crew-Couch/Restraint and Load-Attenuation Systems*. (NASA TN D-7440). Houston, TX: National Aeronautics and Space Administration.
- Dub, M.O., & McFarland, S.M. (2010). Suited Occupant Injury Potential During Dynamic Spacecraft Flight Phases. NASA, Johnson Space Center. Houston: National Aeronautics and Space Administration.
- Ducoff, H.S. (2002). Radiation Hormesis: Incredible or inevitable? *Kor J Bio Sci*, 6, 187–193.
- Durante, M., Bonassi, S., George, K., & Cucinotta, F.A. (2001). Risk Estimation based on Chromosomal Aberrations Induced by Radiation. *Radiat Res*, 156, 662–667.
- Eiband, M. (1959). *Human Tolerance to Rapidly Applied Accelerations: A Summary of the Literature*. (NASA Memo 5-19-59E). Washington, D.C.: National Aeronautics and Space Administration.
- Eiken, O., Kölegård, R., Lindborg, B., Aldman, M., Karlmar, K.E., & Linder, J. (2002). A New Hydrostatic Anti-g Suit vs. a Pneumatic Anti-g System: Preliminary Comparison. *Aviat Space Environ Med*, 73(7), 703–8.
- Engineering Specifications and Standards Department (1983). *Military Specification, System, Aircrew Automated Escape, Ejection Seat Type: General Specification for (08JUN 1983)*. (MIL-S-18471 Rev. G.). Lakehurst, N. J.: United States Naval Air Systems Command .
- English, R.A. & Liles, E.D. (1972) Iridium and Tantalum Foils for Space-flight Neutron Dosimetry. *Health Physics* 22(5), 503-507.
- Farrell, R.J., Booth, J.M., (1975) Design Handbook for Imagery Interpretation Equipment, D180-19063-1, (2-84) Boeing Aerospace Co.
- Fenwick, J. (1992) POGO, Threshold: Pratt & Whitney Rocketdyne's engineering journal of power technology. Retrieved at <http://www.pwengineering.com/articles/pogo.htm> (6/28/2012).
- Fotedar, L. et. al.,(2001). Independent Assessment Report, Review of the ISS Acoustic Requirements, JS-1027. Houston, TX: National Aeronautics and Space Administration.
- Goodman, J.R. (1991a). *STS-40 Acoustical Noise Results and Summary*. Memorandum from Germany, Daniel, Manager, Orbiter and GFE Projects to distribution.
- Goodman, J. (1991). Presentations at the Acoustics Working Group: Specifications and Orbiter Elements Subgroup Status.
- Goodman, J.R., (2003) International Space Station Acoustics, *Proceedings from NOISE-CON*, Cleveland, OH. Inst. of Noise Control Engineering of the USA, Inc., Washington, DC.

- Goodman, J.R. & Grosveld, F.W. (2008). Part III – Noise Abatement Design, *Safety Design for Space Systems*, Ed. Gary Musgrave, Axel Larsen and Tommaso Sgobba, Elsevier Publishing Company.
- Goodman, J.R. & Grosveld, F.W. (2008). Acoustics, In G. Musgrave, L. Larsen, T. Sgobba (Eds.), *Principles of safety design for space systems*, Oxford, Elsevier Science and Technology Books.
- Goodman, J.R. & Villarreal, L.J. (1992) Space Shuttle Crew Compartment Debris/Contamination, SAE Technical Paper Series #921345. Warrendale, PA.
- Graf, R.F. (1974). *Electronic Databook: A guide for designers*, 2nd ed. New York, NY. Van Nostrand Reinhold.
- Graves, C.A., & Harpold, J.C. (1972). *Apollo Experience Report - Mission Planning for Apollo Entry*. NASA TN D-6725.
- Griffin, M.J. (1990). *Handbook of Human Vibration*. London: Academic Press.
- Grosveld, F.W. & Goodman, J.R. (2003). Design of an acoustic muffler prototype for an air filtration system inlet on International Space Station. *Proceedings of NOISE-CON 2003*. Washington, DC: US Institute of Noise Control Engineering.
- Guignard, J.C., & King, P.F. (1972). *Aeromedical Aspects of Vibration and Noise*. AGARD-AG-151. London: Technical Editing and Reproduction, pp. 1-113.
- Harris, C.M., (1998). *Handbook of Acoustical Measurements and Noise Control* (3rd ed.). C.M. Harris (Ed.) Acoustical Society of America, Woodbury, NY.
- Hathaway, D., Wilson, R., & Reichmann, E. (1994). The shape of the sunspot cycle. *Solar Physics*, 151(1), 177–190.
- Heimback, R.D., & Sheffield, P.J. (1996). Decompression Sickness and Pulmonary Overpressure Accidents. In R. L. DeHart (Ed.) *Fundamentals of Aerospace Medicine*, (2nd ed., Chapter 7, pp. 131–161). New York, NY: Williams & Wilkins.
- Hill, R.E. (1992). *Space Shuttle crew module prior noise reduction efforts*. Presentation to the Acoustical Noise Working Group. Houston, TX: NASA Johnson Space Center.
- Hill, R.E. (1994). *Space Shuttle Orbiter crew compartment acoustic noise - environments and control considerations*. Report 94SSV154970. Houston, TX: Rockwell International.
- Hornick, J. (1973). Vibration, in *Bioastronautics Data Book*, 2nd Edition. J.F. Parker, & V.R. West, eds. NASA-SP-3006, Office of Naval Research/NASA, pp. 297-348.
- Horta, L.G., Mason, B.H., Lyle, K.H. (2009) *A Computational Approach for Probabilistic Analysis of Water Impact Simulations*. (NASA-TM-2009-215704). Hampton, VA: National Aeronautics and Space Administration.
- Howe, G.R., Howe, L.B., Zablotska, J.J., Fix, J.E., Buchanan, J. (2004). Analysis of the mortality experience amongst U.S. nuclear power industry workers after chronic low-dose exposure to ionizing radiation, *Radiat Res*, 162, 517–526.
- Hwang, M., Schultz, J., & Sumner, R. (2006). Shuttle Potable Water Quality from STS-26 to STS-114. In *Proceedings from the 2006 International Conference on Environmental Systems*, Norfolk, VA. Society of Automotive Engineers.

IEEE International Committee on Electromagnetic Safety (2005). Current Version. IEEE Standard for Safety Levels with Respect to Human Exposure to Radio Frequency Electromagnetic Fields, 3 kHz to 300 GHz, C95.1-2005. New York, New York.

ISO (1997a) *Mechanical vibration and shock—Evaluation of human exposure to whole body vibration—Part 1: General requirements*. International Standard ISO 2631-1, Second Edition. (Including ISO 2631-1, Amendment 1, 2010.) International Standards Organization.

ISO (1997b) *Mechanical vibration and shock—Human exposure-Vocabulary*. International Standard ISO 5805, Second Edition. International Standards Organization.

ISO (2003). *Danger signals for public and work areas – auditory danger signals*, ISO 7731-2003. International Organization for Standardization, Geneva.

ISO (2003b). *Acoustics - Determination of sound power levels of noise sources using sound pressure - Precision methods for anechoic and hemi-anechoic rooms*. ISO Standard 3745:2003E. Geneva, Switzerland: International Standards Organization.

Johnston, R.S., Dietlein, L. F., & Berry, C. A. (1975). *Biomedical results of Apollo*. (NASA-SP-368; LC-75-600030). Houston, TX: National Aeronautics and Space Administration.

Jones, D.M., & Broadbent, D.E. (1991). Human Performance and Noise. In C.M. Harris (Ed.), *Handbook of acoustical measurements and noise control*, 3rd ed. New York, NY: McGraw-Hill.

JSC 20584. (2008). *Spacecraft Maximum Allowable Concentrations for Airborne Contaminants*. Houston, TX: National Aeronautics and Space Administration.

JSC 26895 (1997). *Guidelines for Assessing the Toxic Hazard of Spacecraft Chemicals and Test Materials*. Houston, TX: National Aeronautics and Space Administration.

JSC 63414, Johnson Space Center, *Spacecraft Water Exposure Guidelines (SWEG)*. Houston, TX: National Aeronautics and Space Administration.

JSC 63828, Biosafety Review Board Operations and Requirements Document. Houston, TX: National Aeronautics and Space Administration.

Kim, M.-H.Y., Cucinotta, F. A., & Wilson, J. W. (2006). Mean occurrence frequency and temporal risk analysis of solar particle events. *Radiation Measurements*, 41(9–10), 1115–1122.

Kim, M.Y., Wilson, J. W., Cucinotta, F. A., et al. (1999). Contribution of high charge energy (HZE) ions during solar-particle event of September 28, 1989. NASA/TP-1999-209320. NASA, Washington, D.C.

Kumar, K.V. & Norfleet, W. T. (1992). *Issues on Human Acceleration Tolerance after Long-Duration Space Flights* (NASA Technical Memorandum 104753). Houston, TX: NASA, JSC.

Lackner, J. R. & DiZio, P. (2000) Human orientation and movement control in weightlessness and artificial gravity environments. *Exp Brain Res* 130: 2–26.

- Lawrence, C., Fasanella, E. L., Tabiei, A., Brinkley, J. W., & Shemwell, D. M. (2008) *The Use of a Vehicle Acceleration Exposure Limit Model and a Finite Element Crash Test Dummy Model to Evaluate the Risk of Injuries During Orion Crew Module Landings*. (NASA-TM-2008-215198). Cleveland, OH: National Aeronautics and Space Administration.
- Lewis, M.E. (2006) Survivability and injuries from use of rocket-assisted ejection seats: analysis of 232 cases. *Aviat Space Environ Med*. 77:936–43.
- Macmillian, A.J.F. (1999). Sub-atmospheric decompression sickness. In J. Ernsting, A.N. Nicholson, & B.H. Rainford (Eds.) *Aviation Medicine*, (3rd ed., Chapter 3, pp. 19–25). New York, NY: Professional Publishing Group, Ltd.
- Magid, E.B., Coermann, R.R., Ziegenruecker, G.H. (1960). Human tolerance to whole body sinusoidal vibration short-time, one-minute and three-minute studies. *Aerospace Medicine*, 31, 915-924.
- Mansfield, N.J. (2005). *Human Response to Vibration*. Boca Raton, Florida: CRC Press.
- Mapes, P. (2006). USAF Helicopter Mishap Data. AFRL-WS 06-2221, United States Air Force, The Human Effectiveness Directorate.
- Martin, B.J., Roll, J.P., & Gauthier, G.M. (1984). Spinal reflex alterations as a function of intensity and frequency of vibration applied to the feet of seated subjects. *Aviation, Space, and Environmental Medicine*, 55, 8-12.
- Martin, C.J. & Sutton, D. G. (Eds.) (2002). *Practical Radiation Protection in Health Care*. Oxford: Oxford University Press.
- McLeod, R.W., & Griffin, M.J. (1986). *A design guide for the visual displays and manual tasks in vibration environments, Part II: Manual Tasks*. Report ISVR-TR-134, Southampton, England: Institute of Sound and Vibration Research, University of Southampton.
- Mertz, H.J., Prasad, P., & Nusholtz, G. (1996). *Head Injury Risk Assessment for Forehead Impacts*, (SAE Technical Paper Series No. 960099). Warrendale, PA: SAE International.
- MIL-STD-1472G (2012). *Department of Defense Design Standard Criteria: Human Engineering*. US Department of Defense.
- MIL-STD-1474D (1997). *Noise Limits*. DoD.
- MIL-S-18471 Rev. G. (1983). *Military Specification, System, Aircrew Automated Escape, Ejection Seat Type: General Specification for (08JUN 1983)*. U.S. Naval Air Systems Command. DoD.
- Mohler, S.R., Nicogossian, A.E.T., McCormack, P.D., & Mohler, S.R., Jr. (1990). Tumbling and spaceflight: the Gemini VIII experience. *Aviat Space Environ Med*, 61, 62–6.
- Mohr, G.C., Brinkley, J.W., Kazarian, L.E., & Millard, W.W. (1969) Variations in Spinal Alignment in Egress Systems and Their Effect. *Aerospace Med*. 40(9):983-988.

- Moseley, M.J., Lewis, C.H., & Griffin, M.J. (1982) Sinusoidal and random whole-body vibration: comparative effects of visual performance. *Aviation, Space, and Environmental Medicine*, 53, 1000-1005.
- MSFC-STD-267A (1966). *Human Engineering Design Criteria*. George C. Marshall Space Flight Center, pp. 261-270.
- Murray, R.H., & McCally, M. (1973). Combined environmental stresses, in *Bioastronautics Data Book*, 2nd Edition. J.F. Parker, & V.R. West, eds. NASA-SP-3006, Office of Naval Research/NASA, pp. 881-914.
- National Academy of Sciences. (1996). NAS. National Academy of Sciences Space Science Board, Report of the Task Group on the Biological Effects of Space Radiation. Radiation Hazards to Crews on Interplanetary Mission. Washington, DC: National Academy of Sciences.
- National Aeronautics and Space Administration, Langley Research Center, Hampton, VA, 1997. [available online at techreports.larc.nasa.gov/ltrs/PDF/1997/cp/NASA-97-cp3360.pdf]
- National Aeronautics and Space Administration (2008) *Columbia Crew Survival Investigation Report*. (NASA-SP-2008-565) Houston, TX.
- National Aeronautics and Space Administration (1995) *Man-Systems Integration Standards (MSIS), Revision B*, (NASA-STD-3000) Houston, TX: NASA, JSC.
- National Aeronautics and Space Administration (2007). *Space Flight Human System Standard, Volume 1, Crew Health*. (NASA-STD-3001 Volume I) Houston, TX.
- NASA/TP-2010-216134. Recommendations for Exploration Spacecraft Internal Atmospheres: The Final Report of the NASA Exploration Atmospheres Working Group. Houston, TX: NASA, JSC.
- National Center for Statistics and Analysis (2009). *Motor Vehicle Traffic Crash Fatality Counts and Estimates of People Injured for 2007*. (DOT HS 811 034). Washington, D.C.: U.S. Department of Transportation, National Highway Traffic Safety Administration.
- NCRP 98 (1989). National Council on Radiation Protection and Measurements, NCRP. Guidance on Radiation Received in Space Activities. NCRP, Bethesda, MD.
- NCRP 132 (2000). Protection Guidance for Activities in Low-Earth Orbit. National Council on Radiation Protection and Measurements, Bethesda, Maryland.
- NCRP 142 (2000). Operational Radiation Safety Program for Astronauts in Low-Earth Orbit: A Basic Framework. National Council on Radiation Protection and Measurements, Bethesda, Maryland.
- National Highway Traffic Safety Administration (1995). *Final Economic Assessment, FMVSS No. 201, Upper Interior Head Protection*. (Federal Motor Vehicle Safety Standard No. 201) Washington, D. C.: U. S. Department of Transportation.
- National Highway Traffic Safety Administration (2012) *Motorcycle Helmets*. (Federal Motor Vehicle Safety Standard No. 218) Washington, D. C.: U. S. Department of Transportation.

- National Research Council. (1996). Biological Issues and Research Strategies. In *Radiation Hazards to Crews of Interplanetary Missions*. Washington, DC: National Academy Press.
- Nealis, G.D. (1982). Acoustic Analysis for STS-3, Houston, TX: NASA, JSC.
- NIOSH. (1998). National Institute for Occupational Safety and Health, Criteria for a Recommended Standard: Occupational Noise Exposure, NIOSH Publication No. 98-126.
- NIOSH. (1990). Occupational Noise and Hearing Conservation Selected Issues, NIOSH comments on the 115-dBA ceiling limit, <http://www.cdc.gov/Niosh/noise2a.html#PAR3>, 1990.
- O’Conner, E.W. (1995). Space vehicle fan package acoustic characteristics. SAE Technical Paper 951647. *Society of Automotive Engineering*.
- O’Neill, P.M. (2007). Badhwar – O’Neill 2007 Galactic Cosmic Ray (GCR) Model Using Advanced Composition Explorer (ACE) Measurements For Solar Cycle 23. (NASA Doc ID 20070009876). Houston, TX: National Aeronautics and Space Administration.
- Öhrström, E. & Björkman, M. (1988). Effects of noise-disturbed sleep—a laboratory study on habituation and subjective noise sensitivity. *J Sound Vibration*, 122, 277–290.
- Park, H., Shin J., & Shim, D. (2007). Mechanisms of vibration-induced nystagmus in normal subjects and patients with vestibular neuritis. *Audiology & Neurootology*., 12, 189-197.
- Parker, J.F. & West, V.R. (1973). *Bioastronautics Data Book* (2nd ed., NASA SP-3006). Washington, DC: NASA Scientific and Technical Information Office.
- Parsons, J.L. & Townsend, L.W. (2000). Interplanetary Crew Dose Rates for the August 1972 Solar Particle Event. *Radiat Res*, 153(6), 729–733.
- Pearsons, K.S. (1975). Recommendations for Noise Levels in the Space Shuttle. Bolt, Beranek and Newman Job No. 157160.
- Peterson, A.F. (1980). Handbook of Noise Measurement-9th. Edition. General Radio, Inc.
- Pilkinton, G.D. & Denham, S.A. (2005). Accuracy of the International Space Station acoustic modeling. *Proceedings of NOISE-CON 2005*. Washington, DC: US Institute of Noise Control Engineering.
- Pilmanis, A.A. & Webb, J.T. (1996). The Effect of Gender on Susceptibility to Altitude Decompression Sickness. Defense Technical Information Center. Brooks Air Force Base, San Antonio, TX. Ascension Number ADA328256. [available online at <http://handle.dtic.mil/100.2/ADA328256>]
- Plaza-Rosado, H. (1991). Naturally induced secondary radiation in interplanetary space: Preliminary analyses for gamma radiation and radioisotope production from thermal neutron activation. NASA Doc # 19920004637, NASA (non Center Specific).

- Preston, D.L., Shimizu, Y., Pierce, D.A., Suyumac, A. & Mabuchi, K. (2003). Studies of Mortality of Atomic Bomb Survivors. Report 13: Solid Cancer and Non-cancer Disease Mortality: 1950–1997. *Radiat Res*, 160, 381–407.
- Radford, T., Ji, H., Parthasarathy, M., Kosarek, P., Watkins, R. & Santini, J. (2011) Next Generation Space Suit Injury Assessment. (AIAA 2011-5107). Proceeding of the 41st International Conference on Environmental Systems, Portland, OR: 1365-79.
- Rasmussen, G. (1982). *Human Body Vibration Exposure and its Measurement* Technical Review Bruel & Kjaer Instruments, Inc. 1982.
- Ricks, R.C. & Lushbaugh, C.C. (1975). Radiosensitivity of Man: Based on Retrospective Evaluations of Therapeutic and Accidental Total-body Irradiation, Final Unclassified Report. Ridge Associated Universities.
- Roscoe, A.H. (1984). *Assessing Pilot Workload in Flight: Flight Test Techniques*. NATO Advisory Group for Aerospace Research and Development, AGARD-CP-373.
- Roth, E.M. & Benjamin, F.B. (1968). Compendium of Human Responses to the Aerospace Environment, Volume III. NASA CR-1205 (III). Lovelace Foundation for Med Ed & Research, Washington, D.C, Government Printing Office.
- Roth, E.M., & Chambers, A.N. (1968). Vibration, in *Compendium of Human Responses to the Aerospace Environment*: Vol. II, E.M. Roth editor. NASA CR-1205(II), pp. 8-1 to 8-112.
- Rupert, A.H., Guedry, F.E., & Reschke, M.F. (1994). The use of a tactile interface to convey position and motion perceptions. In *AGARD, Virtual Interfaces: Research and Applications*, NATO Advisory Group for Aerospace Research and Development, (pp. 1-7).
- Salerno, M.D., Brinkley, J.W. & Orzech, M.A. (1987). Dynamic Response of the Human Head to +Gx Impact. *SAFE Journal*, 17(4), 74-79.
- Schimmerling, W. & Curtis, S.B. (1978). Workshop on the Radiation Environment of the Satellite Power System. Lawrence Berkeley National Laboratory. Paper LBL-8581. [available online at: <http://repositories.cdlib.org/lbnl/LBL-8581>]
- Schultz, J., Plumlee, D., & Mudgett, P. (2006). Chemical Characterization of U.S. Lab Condensate. In *Proceedings from the 2006 International Conference on Environmental Systems*, Norfolk, Virginia.
- Seagull, F.J., & Wickens, C.D. (2006). *Vibration in command and control vehicles: Visual performance, manual performance, and motion sickness: A review of the literature*. Technical Report HFD-06-07/FEDLAB-06-01, Human Factors Division, Institute of Aviation, University of Illinois at Urbana-Champaign.
- Seed, T.M., Fritz, T.E., Tolle, D.V. & Jackson W.E. (2002). Hematopoietic responses under protracted exposures to low daily dose gamma irradiation. *Adv Space Res.*, 30(4), 945–55.
- Shavers, M.R., Zapp, N., Barber, R.E., et al. (2004). Implementation of ALARA radiation protection on the ISS through polyethylene shielding augmentation of the Service Module Crew Quarters. *Adv Space Res*, 34(6), 1333–1337.

- Shea, M. & Smart, D. (2004). The Use of Geophysical Data in Studies of the Historical Solar-Terrestrial Environment. *Solar Physics*, 224(1), 483–493.
- Silberberg, R., Tsao, C.H., Adams, Jr., J.H., & Letaw, J.R. (1984). LET - Distributions and Doses of HZE Radiation Components at Near-Earth Orbits. *Advances in Space Research*, 4(10), (143-151) Oxford, Elsevier Science.
- Simonsen, L. C., Nealy, J.E., Townsend, L.W., & Wilson, J.W. (1990). *Space Radiation Shielding for a Martian Habitat* (SAE Technical Paper Series 901346). Warrendale, PA: SAE International.
- Simpson, J.A. (1983). Elemental and Isotopic Composition of the Galactic Cosmic Rays. *Annual Review of Nuclear and Particle Science*, 33(1), 323–382.
- Smith, S.D., Goodman, J.R., & Grosveld, F.W. (2008). Vibration and acoustics, in *Fundamentals of Aerospace Medicine, 4th Edition*. J.R. Davis, R. Johnston, J. Stepanek, J.A. Fogarty editors, Philadelphia: Lippincott, Williams & Wilkins, pp. 110-141.
- Society of Automotive Engineers (2007a) *Instrumentation for Impact Test – Part 1 – Electronic Instrumentation*. (SAE Standard J211/1). Warrendale, PA.
- Society of Automotive Engineers (2007b) *Sign Convention for Vehicle Crash Testing* (SAE Standard J1733). Warrendale, PA.
- Somers, J.T., Granderson, B., & Scheuring, R. (2010). *Occupant Protection at NASA*. JSC-CN-21380, NASA Johnson Space Center, Houston, TX.
- Somers, J.T., Granderson, B.G., Melvin, J.W., Tabiei, A., Lawrence, C., Feiveson, A., Gernhardt, M., Ploutz-Snyder, R., Patalak, J. (2011) Development of Head Injury Assessment Reference Values Based on NASA Injury Modeling. *Stapp Car Crash Journal*. Nov;55:49-74.
- Space Shuttle Flight Data Briefing, August 1991. (incomplete reference)
- SSP 57000 (2000). Pressurized Payload Interface Requirements Document, Rev. E. ISS Program, Houston, TX: National Aeronautics and Space Administration.
- Stapp, J. P. & Gell, C.F., (1951). "Human exposure to linear declarative force in the backward and forward facing seated positions." *Military Surgeon* 109(2), 106–109.
- Straub, J., Plumlee, D., & J. Schultz, J. (2006). ISS Expeditions 10 & 11 Potable Water Sampling and Chemical Analysis Results. In *Proceedings from the 2006 International Conference on Environmental Systems*, Norfolk, Virginia.
- Striepe, S.A., Nealy, J.E., & Simonsen, L.C. (1992). Radiation Exposure Predictions for Short-Duration Stay Mars Missions. *J Spacecr Rockets*, 29(6), 801–807.
- Takhounts, E., Hasija, V., Ridella, S., Rowson, A., & Duma, S. (2011). Kinematic Rotational Brain Injury Criterion (BRIC). Proceedings of the 22nd International ESV Conference, 11-0263.
- Tang, P., Goodman, J., & Allen, C.S. (2003). Testing, evaluation, and design support of the Minus Eighty Degree Laboratory Freezer (MELFI) payload rack. *Proceedings of NOISE-CON 2003*. Washington, DC: US Institute of Noise Control Engineering.

- Temple, W.E., Clarke, N.P., Brinkley, J.W., & Mandel, M.J. (1964). Man's short-time tolerance to sinusoidal vibration. *Aerospace Medicine*, 35(10), 923-930.
- Thomas, W.E. Jr. (1971) *A Fortran V Program for Predicting the Dynamic Response of the Apollo Command Module to Earth Impact*. (NASA TN D-6539). Houston, TX: National Aeronautics and Space Administration.
- Thompson. (1986). Space Station Advanced EVA Systems Design Requirements, D180-28806-3. Boeing Aerospace Company, Houston, TX: NASA, JSC.
- Tobias, L. (1967). Apollo Applications Program Payload Integration Technical Study and Analysis Report, ED-2002-210. Bendix Corp.
- Townsend, L.W., Cucinotta, F.A., & Wilson, J.W. (1992). Interplanetary Crew Exposure Estimates for Galactic Cosmic Rays. *Radiat Res*, 129, 48-52.
- Townsend, L.W., Stephens, Jr., D.L., Hoff, J.L., et al. (2006). The Carrington event: Possible doses to crews in space from a comparable event. *Advances in Space Research*, 38(2), 226-231.
- Tripp, L. (2007). Assessment of Gravito-Inertial Loads Environment (AGILE) Workshop. Houston, TX.
- Tsiolkovsky, K.E. (1954) *The investigation of space by means of reactive devices*. In: Sobranie sochinenii K.E. Tsiolkovskogo, vol. 2 Academy of Science of the USSR, Moscow, p. 127 (Translated in: *Collected Works of K.E. Tsiolkovsky Volume II – Reactive Flying Machines*. Ed: Blagonravov, A.A. NASA TT F-237, 1965)
- Ullrich, R.L. (1983). Tumor induction in BALB/c female mice after fission neutron or gamma irradiation. *Radiat Res*, 93(3), 506-15.
- Vincze, J. (1966). *Gemini Spacecraft Parachute Landing System*. Washington, D.C.: National Aeronautics and Space Administration.
- Vogt, H.L., Coermann, R.R., & Fust, D.D. (1968). Mechanical impedance of the sitting human under sustained acceleration. *Aerospace Medicine*, 39, 675-679.
- Vogt, H.L., Krause, H.E., Hohlweck, H., & May, E. (1973). Mechanical impedance of supine humans under sustained acceleration. *Aerospace Medicine*, 44, 675-679.
- Von Diringshofen, H. (1942). *Luftfahrtmedizin*. 6, 152-65.
- Vykukal, H.C. (1968). Dynamic response of the human body to combined vibration when combined with various magnitudes of linear acceleration. *Aerospace Medicine*, 39, 1163-1166.
- Vykukal, H.C., & Dolkas, C.B (1966). Effects of combined linear and vibratory accelerations on human body dynamics and pilot performance capabilities. Presented to the 17th International Aeronautical Congress, Madrid, Spain, October 9-15.
- Waligora, J.M., Powell, M.R., & Sauer, R.L. (1994). Spacecraft Life Support Systems. In A.E. Nicogossian, C.L. Huntoon, & S.L. Pool (Eds.). *Space Physiology and Medicine* (3rd ed.). Philadelphia, PA: Lea & Febiger.
- Webb, P. (1964). Impact and vibration in *Bioastronautics Data Book*. P. Webb, ed. NASA-SP-3006, Office of Naval Research/NASA, pp. 63-85.

- Welsh, D.A., Smith, H.A., Wang, S., & Allen C.S. (2011). Acoustic noise prediction of the Amine Swingbed ISS EXPRESS rack payload, *Proceedings of International Conference on Environmental Systems, AIAA 2011-5103*.
- Wheelwright, C.D. (1981). General Specification: *Environmental Criteria for Crew Compartment Design*, JSC-07387B, SC-E-0010, NASA-JSC.
- Whitnah, A.M. & Howes, D.B. (1971) *Statistics Concerning the Apollo Command Module Water Landing, Including the Probability of Occurrence of Various Impact Conditions, Successful Impact, and Body X-Axis Loads* (NASA TM X-2430). Washington, D. C.: National Aeronautics and Space Administration.
- Wickens, C.D., Sandry, D., & Vidulich, M.I. (1983). Compatibility and resource competition between modalities of input, central processing, and output: Testing a model of complex task performance. *Human Factors*, 25, 227–228.
- Wiederhoeft, C.J., Schultz, J.R., Michalek, W.F., & Sauer, R.L. (1999). Reduction in the Iodine Content of Shuttle Drinking Water: Lessons Learned, International Conference on Environmental Systems, paper number 1999-01-2117. [available online at <http://www.urc.cc/pubs/URC-1999c.pdf>]
- Wilson, J.W., Badavi, F.F., Cucinotta, F.A., et al. (1995). *HZETRN: Description of a Free-Space Ion and Nucleon Transport and Shielding Computer Program* (NASA Technical Paper 3495). Houston, TX: National Aeronautics and Space Administration.
- Wilson, J.W., Kim, M., Schimmerling, W., et al. (1995). Issues in space radiation protection: Galactic cosmic rays. *Health Physics*, 68, 50–58.
- Wilson, J.W., Miller, J., Konradi, A., & Cucinotta, F.A. (Eds.) (1997) *Shielding Strategies for Human Space Exploration*. (NASA Conference Publication 3360),
- Wilson, J.W., Nealy, J.E., Wood, J.S., et al. (1995). Variations in Astronaut Radiation Exposure Due to Anisotropic Shield Distribution. *Health Phys*, 69, 34–45.
- Wilson, J.W., Tripathi, R.K., Mertens, C.J., et al. (2005). *Verification and Validation High Charge and Energy (HZE) Transport Codes and Future Development* (NASA TP-2005-213784). Houston, TX: National Aeronautics and Space Administration.

TABLE of CONTENTS

7	HABITABILITY FUNCTIONS	583
7.1	INTRODUCTION	583
7.2	FOOD AND NUTRITION.....	583
7.2.1	Introduction	583
7.2.2	Nutrition	583
7.2.2.1	General Considerations	583
7.2.2.2	Metabolic Intake.....	585
7.2.2.3	Macronutrients.....	586
7.2.2.4	Micronutrients	586
7.2.3	Food System.....	588
7.2.3.1	Galley Area	588
7.2.3.2	Food Preparation, Consumption, and Cleanup	590
7.2.3.3	Food Packaging	592
7.2.3.4	Food Types.....	593
7.2.4	Risk of an Inadequate Food System for Long-Duration Missions	596
7.2.5	Space Radiation.....	597
7.2.6	Research Needs	597
7.3	PERSONAL HYGIENE	599
7.3.1	Introduction	599
7.3.2	General Considerations	599
7.3.3	Research Needs	602
7.4	BODY WASTE MANAGEMENT.....	603
7.4.1	Introduction	603
7.4.2	General Considerations	603
7.4.3	Research Needs	606
7.5	EXERCISE COUNTERMEASURES.....	607
7.5.1	Introduction	607
7.5.2	Mission Concept Planning Considerations	607
7.5.2.1	Quantity of Equipment	607
7.5.2.2	Mission Fitness Level.....	607
7.5.2.3	Exercise Scheduling	608
7.5.3	Physiological Drivers & Performance Needs.....	608
7.5.3.1	Aerobic Capacity	608
7.5.3.2	Musculature System	609
7.5.3.3	Skeletal System (Bone Loss)	609
7.5.3.4	Sensorimotor System	609
7.5.3.5	Decompression Sickness (DCS) Prevention.....	610
7.5.3.6	Psychological Support.....	610
7.5.4	Vehicle and Operational Resource Considerations	610
7.5.4.1	Operational Time, Usage, and Placement	610
7.5.4.2	Volume.....	611
7.5.4.3	Mass	615
7.5.4.4	Mounting and Structural System.....	615
7.5.4.5	Localized Environmental Controls.....	615

7.5.4.6	Power Systems	615
7.5.4.7	Software and Data Systems	616
7.5.4.8	Reliability and Maintenance	616
7.5.5	Previous Types of Spaceflight Exercise Equipment	616
7.5.5.1	Treadmills	616
7.5.5.2	Cycle Ergometers	617
7.5.5.3	Resistive Exercise Devices	617
7.5.5.4	Other Exercise Devices	619
7.5.5.5	Non-Exercise Countermeasure Devices	619
7.5.6	Research Needs	619
7.6	MEDICAL	620
7.6.1	Introduction	620
7.6.2	General Considerations	620
7.6.3	Size and Layout	620
7.6.4	Medical Interfaces	620
7.6.4.1	Decision Aids	621
7.6.5	Stowage	622
7.6.6	Research Needs	622
7.7	STOWAGE	623
7.7.1	Introduction	623
7.7.2	General Considerations	623
7.7.3	Research Needs	626
7.8	INVENTORY MANAGEMENT	627
7.8.1	Introduction	627
7.8.2	General Considerations	627
7.8.3	Inventory Management System Technology	629
7.8.4	Research Needs	629
7.9	TRASH MANAGEMENT	630
7.9.1	Introduction	630
7.9.2	General Considerations	630
7.9.3	Types and Sources of Trash	632
7.9.4	Trash Classifications	632
7.9.4.1	Hazardous Waste	632
7.9.4.2	Nonhazardous Waste	633
7.9.4.3	Toxic Waste	633
7.9.5	Containment, Handling, and Labeling	633
7.9.5.1	Trash Containers	634
7.9.5.2	Trash Disposal Planning	634
7.9.6	Research Needs	635
7.10	SLEEP	636
7.10.1	Introduction	636
7.10.2	General Sleep Considerations	636
7.10.3	Sleep Area Design Considerations	636
7.10.4	Research Needs	639
7.11	CLOTHING	640
7.11.1	Introduction	640

7.11.2	General Considerations	640
7.11.3	Disposable vs. Reusable Clothing.....	641
7.11.4	Clothing Quantities and Frequency of Change.....	641
7.11.5	Clothing Packaging and Storage	641
7.11.6	Research Needs	642
7.12	HOUSEKEEPING	643
7.12.1	Introduction	643
7.12.2	General Considerations	643
7.12.3	Contamination Sources	643
7.12.4	Housekeeping Tools.....	644
7.12.5	Housekeeping Minimization Through System Design	645
7.12.6	Summary of Past and Present On-Orbit Housekeeping Operations	646
7.12.7	Research Needs	649
7.13	RECREATION.....	650
7.13.1	Introduction	650
7.13.2	General Considerations	650
7.13.3	Research Needs	650
7.14	REFERENCES.....	651

TABLE of FIGURES

Figure 7.3-1	Personal Hygiene Facility Sizing	601
Figure 7.3-2	Skylab Shower.....	602
Figure 7.4-1	Anatomical Dimensions for the Design of Body Waste Management Facilities.....	606
Figure 7.5-1	Crew movement operational envelope height.	613
Figure 7.5-2	Crew movement operational envelope width.	613
Figure 7.7-1	View of an optimal translation path with minimal rack front stowage from the ISS US Lab.....	623
Figure 7.7-2	Stowage in the ISS Airlock module.....	624
Figure 7.9-1	Equipment trash bags and empty food containers stowed in the ISS US Node 1 module.....	630
Figure 7.10-1	Examples of Sleep Areas.....	637
Figure 7.12-1	Microbial growth on an ISS panel during ISS Expedition 9.	645

TABLE of TABLES

Table 7.2-1 Estimated Energy Requirements Equations.....	585
Table 7.2-2 Macronutrient Guidelines for Space Flight.....	586
Table 7.2-3 Micronutrient Guidelines for Space Flight.....	587
Table 7.2-4 Microbiology Acceptability Limits for Spaceflight Food.....	590
Table 7.2-5 Water and Oxygen Transmission Rates of Food Packaging Materials.....	592
Table 7.2-6 Types of Food and Packaging for Spaceflight.....	596
Table 7.3-1 Personal Hygiene Byproducts.....	600
Table 7.4-1 Waste Products	605
Table 7.4-2 Anatomical Dimensions for the Design of Body Waste Management Facilities.....	605
Table 7.5-1 Example Exercise Volumes.....	612
Table 7.5-2 Spaceflight Exercise Devices (Rucker, 2004).....	619
Table 7.9-1 Hazardous Waste Classification.....	632
Table 7.10-1 Sleep System Considerations for Different Mission Durations	638
Table 7.10-2 Sleep System Functions and Design Considerations	639
Table 7.11-1 ISS Housekeeping Tasks.....	647

7 HABITABILITY FUNCTIONS

7.1 INTRODUCTION

This chapter provides design considerations for the daily functions of the crew inside the spacecraft, including dining, sleep, hygiene, waste management, and other activities to ensure a habitable environment.

7.2 FOOD AND NUTRITION

7.2.1 Introduction

This section discusses nutritional needs for the crew during spaceflight, as well as design considerations for the food system to ensure nutrition, safety, and acceptability. Food provides both energy and nutrients required for sustaining basic life-support functions and physical work. Energy needs in space are similar to those on Earth, and depend on gender, age, body mass, height, and general activity level.

7.2.2 Nutrition

Nutrition has been critical in every phase of exploration on Earth, from the time when scurvy plagued seafarers to the last century when polar explorers died from malnutrition or, in some cases, nutrient toxicities. The role of nutrition in space exploration will be no different, except that during space exploration, there is no opportunity to obtain food from the environment.

7.2.2.1 General Considerations

Nutritional assessments of the *Mir* and the International Space Station (ISS) crews have documented a range of issues including inadequate caloric intake, weight loss, and decrements in status of individual nutrients (even in cases where intake was adequate). For some nutrients (e.g., calcium), status appears to have declined during spaceflight, but for others excess is a concern (e.g., protein, sodium, iron).

Key areas of concern for the health of the crew during long-duration spaceflight and exploration-class missions include loss of body mass (inadequate food intake), loss of bone and muscle, increased radiation exposure, and depletion of body nutrient stores because of inadequate food supply and increased metabolism. Cardiovascular and/or immune system changes noted during and after spaceflight may also be related to nutritional issues, but conclusive data is not yet available.

Nutrient deficiency due to inadequate supply or stability or increased metabolism and excretion of nutrients can lead to illness and/or performance decrements. Nutritional status has to be adequate before flight to ensure that crews are healthy at the start of the mission.

In the general sense, the primary nutritional requirement is to have a viable and stable food system that the crew is willing and able to consume. The viability of the food system requires not only that food be available for consumption, but that the food has the right nutrient mix to maintain crew health over time. Likewise, a crew's willingness to consume these nutrients is impacted by the variety and flavor of the food. The risk factors for nutrition in spaceflight have a tiered structure, as described following.

1. Inadequate nutritional content available through the food system represents a critical risk. Food may lack adequate nutritional content for several reasons. First, the food available to the crew may be nutritionally deficient when initially provided. Second, the food may lose nutritional value before consumption due to the instability of these nutrients over an extended period of time. Third, there is a risk that the spacecraft environment, especially radiation, may impact these foods and nutrients. Ground-based radiation (used for food preservation) is known to damage certain vitamins, lipids, and amino acids.
2. Inadequate consumption of food by the crew is also a critical risk. Many crewmembers on long-duration space missions have not consumed adequate amounts of food. On exploration-class missions, food freshness, menu fatigue, stress, and other factors will play a significant role in food consumption, which will in turn impact crew health and performance. The in-flight factors affecting food intake make it imperative to provide food with high acceptability to promote consumption. Currently, a quantitative 9-point Hedonic scale is used to evaluate multiple quality factors of each potential flight food item (Meilgaard, Civille, & Carr, 1999). Newly developed foods are tested for acceptability by 30 panelists; items that receive an overall score of 6.0 or higher are included in the space food system. Every subsequent production lot is evaluated by at least 4 panelists prior to spaceflight.

The following factors affect the acceptability of the food and the appetite of the crewmembers:

Past experience and personal preference – Generally, a taste for new foods has to be acquired. This is an important consideration with international crews.

Variety – Food can lose its acceptance if eaten too frequently. A wide variety of foods is desirable. Food may also be varied by changing the form, texture, and flavor, without significantly affecting nutritional content. The use of colors, shapes, garnishes, condiments, and portions in meal presentation, as well as packaging color, utensil shape and size, and visual display of trays may also enhance the eating experience. Long-duration ISS crews have commented that variety is lacking when foods are provided to them in an 8-day cycle. The crew did prefer having foods from the Russian and U.S. menus available at the same time. Currently on ISS, NASA provides food for 3 crewmembers and Russia provides food for 3 crewmembers. Both menus provide an 8-day cycle. Crewmembers are allowed to share food per their discretion.

Availability – Snacks should be available with a minimum of preparation. This is particularly important for high-energy-output tasks such as extravehicular activity (EVA) operations.

Food form – The more Earth-normal the quality of the food, the more acceptable it will be. This includes the desirability of fresh fruits and vegetables.

Meal scheduling – Lack of consistent meal periods in the crew schedule can lead to skipped meals and undernourishment.

0g environment – Some U.S. and Russian space crews have reported that changes occur in their taste and odor perception of foods during spaceflights. This may be caused by a shift in the distribution of body fluid that results in head congestion. Another possible factor is that reduced air circulation in 0g and competing odors in the closed spacecraft reduce the crew's ability to smell the food. About 85% of flavor is based on aroma. Due to the fact that the loss of flavor is more profound for some individuals, condiments are flown to allow the crewmembers to individually alter the flavors of the foods.

Waste management facilities – In the past, inadequate body waste management facilities have discouraged food consumption. (Refer to section 7.4 Body Waste Management for design requirements of body waste management facilities.)

Space motion sickness (SMS) – Control of SMS is essential for a healthy appetite.

Atmospheric contaminants – The buildup of background odors during missions may contribute subliminally to a decrease in appetite and consumption as a result of fatigue or adaptation.

Guidelines for nutrition requirements are documented in “JSC 63555, Nutrition Requirements, Standards, and Operating Bands for Exploration Missions,” JSC NASA Nutritional Biochemistry Group, December 2005, Initial Release (Revision 1). They are based on many sources of information that were reviewed at a Nutrition Standards/Operating Bands workshop held March 23–24, 2005, in Houston, Texas. These sources included the set of nutritional requirements defined in 1991 for Space Station Freedom missions, plus the updated set of requirements developed in 1995 (in collaboration with Russian partners) for *Mir* flights. Workshop participants also evaluated the limited data from short-duration Space Shuttle flights and longer *Mir* and ISS flights. Data from the ISS included the findings from the Medical Requirement (MR016L, (JSC 28913, 2005)) “Clinical Nutritional Assessment” profile of the first 10 ISS missions, which provided background information about the changes seen in flights of 4 to 6 months (during which time resupply by at least one Progress spacecraft occurred). To establish the nutritional guidelines at the 2005 workshop, the workshop participants in many cases made extrapolations from ground-based space analog studies, and in others had only ground-based nutrition literature for support. The food provided must be of sufficient quality, quantity, and nutrient content to meet the energy demands of various activities while accommodating each crewmember’s individual needs and desires.

7.2.2.2 Metabolic Intake

The estimated energy requirements (EER) for crewmembers during space missions must be based on total energy expenditure (TEE), using an activity factor of 1.25 (active) along with the individual’s age, body mass (kg), and height (m) according to Table 7.2-1.

Table 7.2-1 Estimated Energy Requirements Equations

<p><u>EER for men 19 years old and older</u> $EER \text{ (kcal/day)} = 622 - 9.53 \times \text{Age [y]} + 1.25 \times (15.9 \times \text{Mass [kg]} + 539.6 \times \text{Height [m]})$</p> <p><u>EER for women 19 years old and older</u> $EER = 354 - 6.91 \times \text{Age [y]} + 1.25 \times (9.36 \times \text{Mass [kg]} + 726 \times \text{Height [m]})$</p>
--

For EVA operations, an additional 200 kilocalories per EVA hour must be provided for EVA crewmembers. Additional energy and nutrients are necessary during EVA operations, as crewmember energy expenditure is greater during those activities. Lean body (especially muscular) weight maintenance is a key component of preserving crew health during missions and keeping performance at a level required to complete mission objectives. Consumption of an additional 200 kilocalories (kcal), similar in nutrient content to the rest of the diet, per hour of

EVA would allow a crewmember to maintain lean body weight during the course of the mission. This is the metabolic energy replacement requirement for moderate to heavy EVA tasks.

7.2.2.3 Macronutrients

The diet for each crewmember must include macronutrients in the quantities listed in Table 7.2-2. Macronutrients are nutrients that provide calories for energy: carbohydrates, protein, and fat are essential for crew health.

Table 7.2-2 Macronutrient Guidelines for Space Flight

Nutrients	Daily Dietary Intake
Protein	0.8 g/kg
	and $\leq 35\%$ of the total daily energy intake
	and 2/3 of the amount in the form of animal protein and 1/3 in the form of vegetable protein
Carbohydrate	50–55% of the total daily energy intake
Fat	25–35% of the total daily energy intake
Ω -6 Fatty acids	14 g
Ω -3 Fatty acids	1.1–1.6 g
Saturated fat	< 7% of total calories
Trans fatty acids	< 1% of total calories
Cholesterol	< 300 mg/day
Fiber	10–14 grams/4187 kJ

7.2.2.4 Micronutrients

The diet for each crewmember must include micronutrients in the quantities listed in Table 7.2-3. Although macronutrients are very important, they are not the only things we need for survival. Our bodies also need water (6–8 glasses a day; see section 6.3 Water) and micronutrients. Micronutrients are nutrients that our bodies need in smaller amounts, and include vitamins and minerals.

Table 7.2-3 Micronutrient Guidelines for Space Flight

Vitamin or Mineral	Daily Dietary Intake
Vitamin A	700–900 µg
Vitamin D	25 µg
Vitamin K	Women: 90 µg
	Men: 120 µg
Vitamin E	15 mg
Vitamin C	90 mg
Vitamin B ₁₂	2.4 µg
Vitamin B ₆	1.7 mg
Thiamin	Women: 1.1 µmol
	Men: 1.2 µmol
Riboflavin	1.3 mg
Folate	400 µg
Niacin	16 mg niacin equivalents
Biotin	30 µg
Pantothenic acid	30 mg
Calcium	1200–2000 mg
Phosphorus	700 mg
	And $\leq 1.5 \times$ calcium intake
Magnesium	Women: 320 mg
	Men: 420 mg
	And ≤ 350 mg from supplements only
Sodium	1500–2300 mg
Potassium	4.7 g
Iron	8–10 mg
Copper	0.5–9 mg
Manganese	Women: 1.8 mg
	Men: 2.3 mg
Fluoride	Women: 3 mg
	Men: 4 mg
Zinc	11 mg

Vitamin or Mineral	Daily Dietary Intake
Selenium	55–400 µg
Iodine	150 µg
Chromium	35 µg

Note: Compiled from “JSC 63555, Nutrition Requirements, Standards, and Operating Bands for Exploration Missions,” JSC NASA Nutritional Biochemistry Group, December 2005, Initial Release (Revision 1).

The ISS food system includes vitamin D tablets, since vitamin D deficiency is a common issue for astronauts. Any other vitamins provided are per the agreement between the individual astronaut and his or her flight surgeon.

The storage temperature of foods has a direct impact upon the shelf life of the foods, including the quality of nutrients available when the food is consumed. For example, foods will maintain the best quality for the longest times when frozen (<32°F [0°C]). At temperatures above freezing, spoilage and degradation increases appreciably.

Food for the ISS is packaged in a vacuum environment, since reducing oxygen in the package is essential to minimize the rate of rancidity. Atmospheres with abnormally high concentrations of oxygen may result in increased rates of rancidity and nutrient depletion for certain shelf-stable foods.

7.2.3 Food System

This section discusses the food system, including types of food and packaging, storage, preparation, and cleanup. Related topics can be found in the following sections:

Water – See 6.3 Water

EVA Nutrition – See 11.2.3 EVA Nutrition

7.2.3.1 Galley Area

The galley area, as well as the accommodation of the food preparation equipment, must be designed and sized to allow all crewmembers to eat meals at the same time. On ISS, and when it was possible on the Space Shuttle, crews have preferred to eat meals together to promote unity. Sometimes, such as during crew handovers, the number of crewmembers to be accommodated will be larger than usual.

In 0g, a smaller volume of space may be used for preparing and eating food if proper layout and co-location of food storage areas, warmers and hydration equipment, and eating and restraining surfaces are considered during design.

7.2.3.1.1 Location

The galley should be located in an area that is conducive to conversation and relaxation, and not in an area with high traffic flow. The ISS Service Module galley area has been described as noisy because of work, exercise, and fans. Proper lighting conditions must be provided, to ensure that food can be properly seen and spills can be quickly identified. Location in relation to waste and hygiene areas is also important to consider. ISS crews have noted that co-locating dining areas

with waste and hygiene areas is not optimal for sanitation or psychological purposes. Apollo crewmembers have also indicated that the galley was too close to the waste management system, and odors from that area resulted in a loss of appetite. The galley must be isolated from waste and hygiene areas to prevent contamination of food by microorganisms in those areas in addition to preventing odors from permeating the eating area.

7.2.3.1.2 Contamination

Location of the food system and food storage should ensure there is no contamination from waste and hygiene areas. Microbiological contamination of food can negatively impact crew health. This can be avoided with the proper processing of food, as well as the design of the food system and spacecraft. Microbial testing must occur after food processing on Earth to ensure that microorganism levels in the food do not exceed those specified in SD-T-0252, *Microbiological Specification and Testing Procedure for Commercially Sterile Foods* and SD-T-0251, *Microbiological Specification and Testing Procedure for Foods which are not Commercially Sterile*. The ability to clean and disinfect the spacecraft will also help to minimize microbial contamination of the food system. Any chemicals on board must be stored to avoid the contamination of any food in storage or during eating. Contamination of the food system by physical debris can jeopardize the safety and health of the crew. In 0g, physical debris such as dirt, regolith, wood, plastic, metal, and small objects must be contained to minimize the risk of contaminating food in storage or during eating.

Table 7.2-4 Microbiology Acceptability Limits for Spaceflight Food

Area/Item	Microorganism Tolerances	
Food Production Area	Samples Collected*	Limits
Surfaces	3 surfaces sampled per day	3 colony-forming units (CFU)/cm ² (Total aerobic count)
Packaging Film	Before initial use	
Air	1 sample of 320 liters	113 CFU/320 liters (Total aerobic count)
Food Product	Factor	Limits
Non-thermostabilized**	Total aerobic count	20,000 CFU/g for any single sample (or if any two samples from a lot exceed 10,000 CFU/g)
	Coliform	100 CFU/g for any single sample (or if any two samples from a lot exceed 10 CFU/g)
	Coagulase positive Staphylococci	100 CFU/g for any single sample (or if any two samples from a lot exceed 10 CFU/g)
	Salmonella	0 CFU/g for any single sample
	Yeasts and molds	1000 CFU/g for any single sample (or if any two samples from a lot exceed 100 CFU/g or if any two samples from a lot exceed 10 CFU/g <i>Aspergillus flavus</i>)
Commercially Sterile Products (thermostabilized and irradiated)	No sample submitted for microbiological analysis	100% inspection for package integrity

* Three samples collected before food processing only on days that the food facility is in operation. Three samples collected at the beginning of the day and after lunch in the packaging facility.

** Food samples that are considered “finished” products that require no additional repackaging are only tested for total aerobic counts.

This table was summarized from SD-T-0252, *Microbiological Specification and Testing Procedure for Commercially Sterile Foods* and SD-T-0251, *Microbiological Specification and Testing Procedure for Foods which are not Commercially Sterile*, and FPS-149 Standard for Food Facility Preparation for Processing Aerospace Foods.

7.2.3.2 Food Preparation, Consumption, and Cleanup

7.2.3.2.1 Heating and Cooling

For missions longer than 3 days, the foods and beverages that would normally be consumed hot must be heated to between 155°F (68°C) and 175°F (79°C). Heating food and liquid enhances

the palatability of these items, which is important for behavioral health as well as ensuring that crewmembers eat the food provided. If the food is not palatable, the crew will not consume it, resulting in inadequate nutrition and energy to perform physically and cognitively. Equipment should include a hot water dispenser and a food warmer capable of heating beverages, rehydratables, thermostabilized (both pouches and cans), and irradiated products. Both Apollo and current crewmembers have stated the importance of hot water for beverages and foods, especially for hot coffee (one of the most requested items). The ISS crew has stated the importance of a working food warmer for long-duration missions. The ISS crews currently heat food packages that are not compatible with the current warmer, which has resulted in damage to latches and hinges on the warmer. A food warmer may be more durable if designed to be compatible with all types of food packaging that the crew may want to put in the warmer.

Equipment should include a cold water dispenser to rehydrate foods and beverages that would normally be consumed cold to between 35.6°F (2°C) and 44.6°F (7°C). Cooling enhances the palatability of some food and drink items, which is important for crew dietary and behavioral health. Also, consideration should be given to providing refrigeration for food packages that have been opened and still contain food for consumption at a later time, as well as for bulk containers of food such as condiments that require refrigeration after opening. Shelf life and safety considerations should be made to determine maximum allowable time in the refrigerator.

While heating food and liquid may require power from the spacecraft, there may be ways to use the heat from several sources in the spacecraft for the galley, instead of radiating it into space. Cooling, on the other hand, may require more energy.

7.2.3.2.2 Preparation Time

Food systems should be designed to efficiently use crew time by minimizing preparation time. Typically, mealtimes have been scheduled for 1 hour, and include not only eating but unstowing of food items, food preparation, cleaning, and stowage of trash and meal-related items. The food warmer should be large enough and heat quickly enough to accommodate all types of food packages for the whole crew, enabling them to eat together. Certain food preparation techniques, such as boiling and convection heating (without forced air), are not possible in 0g.

7.2.3.2.3 Consumption

The type of equipment used to serve and eat the food will affect the design of the food system. Equipment may include restraints, eating surfaces (e.g., trays, plates, table), and utensils. In 0g, restraints must be provided for crewmembers, food, utensils, and other equipment.

7.2.3.2.4 Cleanup

The ability to capture food particles and spills must be provided. In 0g, powdered or flaky foods will separate and disperse, while foods with a high surface tension will remain in open containers without dispersing throughout the spacecraft.

The food system must use materials that are conducive to cleaning. Velcro in the galley area tends to collect food particles and is difficult to clean. The ability to sanitize eating utensils and surfaces must be provided.

Because food substances left on cleaning materials and in packaging will spoil, food system wet waste materials must be properly disposed of and contained to limit microbial contamination. Waste generated from the food system will include both wet and dry materials. Dry materials may include dry food packaging, while wet materials may include leftover food, cleaning materials, and wet food packaging materials.

7.2.3.3 Food Packaging

Different types of packaging are required for different types of food to maintain food quality throughout a mission. The type of packaging used depends on the mission duration. Several types of food and beverage packaging have been used in the NASA space programs. The key consideration for extending food shelf life is preventing contact of the food with oxygen or water, which both cause oxidation and spoilage.

Food packaging materials, by resisting permeation of water vapor and oxygen, protect the food from environmental effects that result in the food becoming stale and rancid, and from microbial contamination. Table 7.2-5 provides data on permeability to water vapor and oxygen for current food system packaging materials (Cooper, Douglas, & Perchonok, 2011).

Table 7.2-5 Water and Oxygen Transmission Rates of Food Packaging Materials

	Oxygen Permeability @ 73.4°F (23°C), 100% RH (cc/100in ² /day) [ASTM F-1927]	Water Vapor Permeability @ 100°F (38°C), 100% RH (g/100in ² /day) [ASTM F-1249]
Overwrap	0.0065	< 0.0003
Thermostabilized & Irradiated Pouch	< 0.0003	0.0004
Rehydratable Lid & Natural Form Pouch	5.405	0.352
Rehydratable Bottom (heat formed)	0.053	0.1784

The current ISS food system incorporates the use of cans for some retorted foods, including all Russian retorted items and a few international partner foods from the European Space Agency and the Japan Aerospace Exploration Agency. Definite disadvantages accompany the use of metal cans when incorporated in a space food system, even though cans provide the optimum barrier against oxygen and moisture permeation. First, metal cans have a higher density than flexible packaging films with similar barrier properties. The result is an increase in the overall mass of the food system if metal cans are used in place of flexible packaging. Second, metal cans are much less efficient to stow, thereby taking up more space than an equivalent number of flexible pouches. At the time of disposal, metal cans remain rigid and the volume cannot be reduced as much as with flexible packaging. This requires a larger volume needed for storage of refuse materials and also for stowage of uneaten foods.

7.2.3.4 Food Types

To maintain food quality throughout a mission, the type of food offered should be carefully considered. No single type of food item can provide the required nutrient content and subjective variety. Maintaining nutrient content and palatability is accomplished by food selection, processing, and packaging. Except for Skylab, no NASA program has had a refrigerator or freezer on board for food storage. Therefore, the food must be shelf-stable. This requires inactivation of the microorganisms in the food during ground processing preflight.

Shelf-stable food has been provided in a number of different forms, including:

- Thermostabilized
- Irradiated
- Rehydratable
- Natural form
- Extended-shelf-life bread products
- Fresh food
- Beverages

7.2.3.4.1 Thermostabilized Food

Thermostabilization is the process of heating food to a temperature that renders it free of pathogens, spoilage microorganisms, and enzyme activity. Food items are placed in cans or pouches and then processed with air-overpressure or water-overpressure to remove excess air or oxygen for specified times and temperatures.

Examples of thermostabilized foods from the ISS menus are beef stew, mocha yogurt, chocolate pudding, split pea soup, tuna casserole, and red beans and rice. NASA gives thermostabilized foods a shelf life of 2 years. These foods are similar to the Meal, Ready-to-Eat (MRE) that is used by the U.S. military.

The thermostabilized ISS food package is a pouch fabricated from a quad-laminate of polyolefin/aluminum foil/polyamide/polyester. The maximum dimensions of the thermostabilized food package (standard entrée size) are 8.12×4.75 in. (20.62×12.06 cm). The maximum thickness of this package is 0.91 in. (2.3 cm). The mass of a filled thermostabilized food package ranges from 3.07 to 8.32 oz (87 to 236 g), with an average of 6.73 oz (191 g).

7.2.3.4.2 Irradiated Food

NASA has special dispensation from the Food and Drug Administration to irradiate nine meat items to a level of commercial sterility (Code of Federal Regulations). Irradiation involves the use of gamma rays, X rays, or electrons, and uses energy levels that ensure negative induction of radioactivity in the irradiated product. Irradiation controls naturally occurring processes such as ripening or senescence of raw fruits and vegetables, and is effective to inactivate spoilage and pathogenic microorganisms. A wide range of products can use this technology, though currently NASA has only been given permission to use irradiation to preserve meats.

Examples of irradiated foods from the ISS menu are beef fajitas and smoked turkey. Although irradiation has been used for several years, more data regarding its efficacy need to be collected. Irradiation will result in a shelf life of 2 years.

The irradiated ISS food package is a pouch fabricated from a quad-laminate of polyolefin/aluminum foil/polyamide/polyester. The maximum dimensions of the irradiated food package are 8.12×4.75 in. (20.62×12.06 cm). The maximum thickness of this package is 0.79 in. (2 cm). The average mass of the filled irradiated food package is 4.37 oz (124 g); the mass of a filled irradiated food package ranges from 3.03 to 6.94 oz (86 to 197 g).

7.2.3.4.3 Rehydratable Food

A number of technologies are available for drying foods. Examples of these technologies are drying with heat, osmotic drying, and freeze drying. These processes reduce the water activity of foods, which results in the inability of microorganisms to thrive. The foods can then be rehydrated to return them to a texture similar to that of the food before it was dried. If water is not produced or recycled during a mission, then rehydratable foods do not provide a mass savings. Examples of rehydratable food from the ISS menu are asparagus, cauliflower with cheese, chicken salad, cornbread dressing, sausage patty, and shrimp cocktail.

The rehydratable ISS food package is fabricated from the following materials:

- a. The base is fabricated from Combitherm PAXX230 [a coextrusion of nylon/medium-density polyethylene (MDPE)/nylon/ethylene-vinyl alcohol (EVOH)/nylon/MDPE/linear low-density polyethylene (LLDPE)].

The lid is fabricated from Combitherm PAXX115 (a coextrusion of nylon/EVOH/nylon/LF adhesive/HV polyethylene/LLDPE).

A septum adapter is fabricated from low-density polyethylene.

A septum fabricated from silicone rubber is sealed in the adapter with a disk fabricated from a laminate of polyester/aluminum foil/polyethylene.

Note: The rehydratable food package is wrapped in a white pouch, 0.003 mm thick, fabricated from a laminate of polyester/polyethylene/aluminum foil/Surlyn®. This wrap is removed before the food is prepared and heated.

The maximum dimensions of the rehydratable food package are 6.10×5.60 in. (15.49×14.22 cm). The maximum thickness of this package is 1.44 in. (3.65 cm). The average mass of the filled rehydratable food package is 1.78 oz (50.6 g); the mass of a filled rehydratable food package ranges from 0.88 to 3.40 oz (25.0 to 96.6 g).

7.2.3.4.4 Natural-Form Food

Natural-form foods are commercially available shelf-stable foods. The moisture of the foods may range from low moisture (e.g., almonds and peanuts) to intermediate moisture (e.g., brownies). These foods rely on reduced water activity to prevent microbial activity. Examples of natural-form foods from the ISS menu are almonds, brownies, cookies, and granola bars.

The package that contains bite-sized natural-form food is fabricated from Combitherm PAXX115, a coextrusion of nylon/EVOH/nylon/LF adhesive/HV polyethylene/LLDPE. This bite-sized-food package is wrapped for storage in a white pouch, 0.003 mm thick, fabricated from a laminate of polyester/polyethylene/aluminum foil/Surlyn®. The dimensions of the package are 7.3×3.5 in. (18.54×8.89 cm). The average mass of the filled bite-sized-food package is 1.76 oz (50 g); the mass of a filled bite-sized-food package ranges from 0.74 to 2.43 oz (21 to 69 g).

7.2.3.4.5 Extended-Shelf-Life Bread Products

Items such as tortillas, scones, waffles, and dinner rolls can be vacuum-packed to give them a shelf life up to 1 year. To safely vacuum-package these bread products, the products must be specially formulated to a water activity level low enough to prevent the growth of anaerobic pathogenic bacteria. Tortillas are packaged in a white pouch measuring 0.003 mm in thickness, and fabricated from a laminate of polyester/polyethylene/aluminum foil/Surlyn[®] with an oxygen absorber to prevent mold growth. Other extended-shelf-life bread products are purchased through the Department of Defense.

7.2.3.4.6 Fresh Food

Foods that have a short shelf life, such as fresh fruit, and vegetables, are provided on a limited basis more for psychological support than as part of meeting dietary requirements. Such fresh foods can only be provided when the time from stowage in a vehicle to reaching orbit is approximately 1 week.

7.2.3.4.7 Beverages

The beverages currently being used on the ISS are either freeze-dried beverage mixes (e.g., coffee or tea) or flavored drinks (e.g., lemonade, orange drink, etc.). The drink mixes are prepared and vacuum-sealed inside a beverage pouch and in the case of coffee or tea, possibly with sugar, artificial sweetener, or powdered cream. Empty beverage pouches are also provided for drinking water.

A straw and tubing clamp accompany the beverage pouch to penetrate the septum to allow drinking and to clamp the straw shut to prevent liquid from leaking out of the pouch and dispersing throughout the spacecraft.

The beverage package is fabricated from a tri-laminate of polyester/aluminum foil/polyethylene. It has a low-density polyethylene septum adapter and a silicone rubber septum sealed in the adapter with a disk cut from the same material as the package. The maximum dimensions of the beverage package are 8.8 × 3.6 in. (22.35 × 9.14 cm). The maximum thickness of this package before hydration is 0.52 in. (1.27 cm). The maximum thickness of a beverage package lying flat horizontally after hydration is 1.18 in. (3 cm). The average mass of the filled beverage package is 0.92 oz (26.1 g); the mass of a filled beverage package ranges from 0.42 to 1.90 oz (12.0 to 54.0 g). These beverage packages require the addition of 6 to 8 oz (180 to 240 mL) of potable water.

Table 7.2-6 provides a summary of the food types and packaging used for the NASA food items.

Table 7.2-6 Types of Food and Packaging for Spaceflight

Food/Packaging Type	ISS Example	Parameters
Thermostabilized	Beef stew Mocha Yogurt Chocolate Pudding Split Pea Soup Tuna casserole Red beans & rice	Shelf life: 2 years Packaging: Quad-laminate pouch Preparation: None or heating
Irradiated	Beef fajitas Smoked turkey	Shelf life: 2 years Packaging: Quad-laminate pouch Preparation: None or heating
Rehydratable	Vegetables Chicken salad Cornbread dressing Sausage patty Shrimp cocktail	Shelf life: 1.5 years with overwrap; 1 year with no overwrap Packaging: Combitherm pouch, adapter for rehydration Preparation: Rehydration using hot or cold water
Natural form	Cookies Brownies Nuts Granola bars	Shelf life: 1.5 years with overwrap; 1 year with no overwrap Packaging: Combitherm pouch Preparation: None
Extended-shelf-life bread products	Waffles Tortillas Wheat flat bread	Shelf life: 1 year Packaging: Quad laminate or packaged by Department of Defense Preparation: None
Fresh food	Fresh fruit Raw vegetables Fresh tortillas	Shelf life: 1 week Packaging: Preparation: None
Beverages	Freeze-dried (coffee or tea) Drink mix (lemonade) Water	Shelf life: 3 years Packaging: Tri-laminate pouch, adapter for rehydration, straw Preparation: Rehydration using hot or cold water

7.2.4 Risk of an Inadequate Food System for Long-Duration Missions

A processed and prepackaged food system has been used for each NASA space program, including the current 6-month ISS missions. The food system is the sole source of nutrition to crewmembers and enhances their psychological health by being a familiar element in an unfamiliar and hostile environment. A significant loss in nutrition, either through loss of nutrients in the food during processing and storage or inadequate food intake due to low acceptability, variety, or usability, may significantly compromise crew health and performance. Recent research has indicated that the current food system will not meet the nutrition, acceptability, or resource requirements of a long-duration mission beyond low-Earth orbit (LEO). Several key nutrients degrade in many foods over the 5-year shelf life that will be

required for such a mission and the packaging required to meet the current 1.5-year shelf life is a significant mass, volume, and waste disposal issue.

Alternative provisioning strategies, such as inclusion of a bioregenerative system, reduce initial resource use and add fresh foods that may benefit crew health, but these alternatives also increase infrastructure and crew time requirements. A bioregenerative system also introduces a significantly greater risk of foodborne illness and food scarcity, which may compromise mission success. Current preflight procedures and the use of prepackaged provisions have ensured food safety so far, but there is currently no technology to enable efficient testing of a bioregenerative system in a resource-constrained environment. Current research is investigating strategies to increase the shelf life of a prepackaged food system, decrease use of vehicle resources, and determine the most effective way to balance resource use with provisioning of an adequate food system. More information is available in the Evidence Document for the Risk of Performance Decrement and Crew Illness Due to an Inadequate Food System:

<http://humanresearchroadmap.nasa.gov/evidence/>.

7.2.5 Space Radiation

Space radiation has not been found to affect food or packaging quality during orbital missions that last up to 9 months on the ISS, but more radiation will be received during missions to the Moon and Mars. Because different types and higher levels of radiation will be encountered during planetary missions, the effect of radiation on food and packaging quality should be considered. The addition of antioxidants to the food may help prevent the formation of free radicals, which contribute to food spoilage. If plants will be grown as a food source on the Moon or Mars, the seeds must be protected from radiation to prevent problems with their growth and nutrient content.

7.2.6 Research Needs

- Determine how the food system can deliver the required level of nutrition throughout the mission.
- Understand the effect of processing, time, and storage conditions on the nutritional content of the food.
- Determine the technology required for in-suit nutrition delivery.
- Determine how the nutrition and acceptability of the food system can be maintained throughout the mission.
- Understand the effect of space radiation on nutrition and acceptability.
- Understand the effect of time and storage conditions on nutrition and acceptability, and how integration of appropriate processing, packaging, products, and storage environment can help to mitigate the effects.
- Test emerging food preservation technologies that will improve quality over thermostabilized and irradiated items.
- Determine how the acceptability of the food system can be maintained through the mission.
- Determine variety, acceptability, and usability requirements for the food system for different mission lengths.

- Understand sensory perception changes at 0g.
- Determine what technologies can be developed that will efficiently balance appropriate vehicle resources such as mass, volume, and crew time.
- Develop an advanced, flexible, clear packaging material with adequate moisture and oxygen barrier properties to extend the food system shelf life to 5 years for long-duration NASA missions.
- Reduce package mass and volume without compromising food quality.
- Conduct a trade study that considers efficiencies and adequacies of a prepackaged versus a bioregenerative food system with a recommendation to the Program.
- Design and test several pieces of food processing equipment and procedures to develop safe and high-quality edible ingredients for further preparation in a galley.
- Design and test several pieces of efficient (minimum power, water, cleaning) food preparation equipment and procedures to develop safe and high-quality recipes in a galley.
- Develop procedures for handling crops to ensure safety of uncooked foods.
- Understand the effect of storage time and seed treatments that ensure long-term safety on seed viability, crop yield, and final food quality and nutrient value.
- Understand the effect of storage time and treatments that extend shelf life of bulk ingredients on functionality, food quality, and nutrient value.
- Understand the benefits of probiotics in a spaceflight environment and develop procedures for their shelf-stable and safe addition into the space food system.
- Determine the adequate dose range of vitamin D supplementation.
- Determine how nutritional status and nutrition requirements change during spaceflight.
- Determine how countermeasures impact nutrition.
- Determine whether a single test can monitor net bone calcium changes.
- Determine the impacts of the spaceflight environment on oxidative damage.
- Determine the interactions of exercise and nutrition in altered weight-bearing environments that mitigate muscle loss.
- Determine what integrated nutritional, exercise, and/or pharmaceutical countermeasures can be used to mitigate bone loss.
- Determine whether nutrition/nutrients can mitigate O₂/radiation damage.
- Determine whether factors in addition to unloading contribute to muscle atrophy during space flight (e.g., radiation, inflammation, hydration, redox balance, energy balance).

7.3 PERSONAL HYGIENE

7.3.1 Introduction

Personal hygiene is important for good health because it eliminates microorganisms and prevents the spread of disease, and it is also important for crew comfort. Personal hygiene includes cleansing of the entire body, including skin, hair, and teeth. This section includes design guidelines for personal hygiene.

7.3.2 General Considerations

Dead skin cells, hair, sweat, and oil foster the growth of bacteria and can be easily removed with soap and water. Crewmembers on short-duration missions, like the Space Shuttle, often perform only partial-body cleansing using disposable wipes and rinse-less shampoo. For longer duration missions, both for cleanliness and crew comfort, reusable towels that can be soaked with water may be preferred. Whole-body cleansing during long-duration missions may be necessary to ensure cleanliness that may be difficult to accomplish with partial-body cleansing. Each crewmember should also have a personal hygiene kit that includes items such as a toothbrush, toothpaste, hair brush, deodorant, shaving supplies, nail clippers, tampons, and contact lens kits.

It is important to note that personal hygiene standards vary with cultural background, and this should be taken into consideration during missions with international crews. People of some cultures traditionally bathe at least once per day and use deodorant, and often find those who do not follow the same traditions to have an unpleasant odor. Odors tend to become more pronounced on space missions because of the confined environment and limited ability for full-body cleansing.

Personal hygiene capabilities must be provided for all missions. Personal hygiene is defined as body washing (whole or partial), oral hygiene, and grooming. It is important to consider the following when designing for personal hygiene:

1. **Psychological Effects** – Good grooming can enhance self-image, improve morale, and increase the productivity of the crewmember. Adequate and comfortable bathing and body waste management facilities have been high on the list of priorities of participants in various space missions. Some modification of personal hygiene practices and procedures may be necessary due to equipment design limitations and water supply restrictions, but should be minimized.
2. **Privacy** – Privacy must be provided for whole-body and partial-body cleaning (including donning and doffing of clothing).
3. **Odor** – Objectionable body odors can rapidly build without adequate personal hygiene facilities. This is a predictable source of interpersonal conflict.
4. **Personal Items** – Personal hygiene items must be provided for each crewmember. Each crewmember needs personal hygiene capabilities for body cleansing, oral hygiene, and personal grooming throughout each space mission. Personal hygiene equipment and supplies must accommodate the physiological differences in male and female crewmembers in the microgravity environment. The supplies should also be able to meet the personal needs and comfort of the crewmembers to the extent possible.
5. **Design for Effective and Efficient Use** – Experiences with the Skylab shower design has shown that personal hygiene facilities will be less frequently used if they are awkward, uncomfortable, or take a large amount of time to use.

6. Feedback – Unfamiliar and inadequate facilities and environment can result in crewmembers falling into patterns of substandard hygiene. The results are likely to be interpersonal conflict and reduced productivity. Provision of full-length mirrors or other means of feedback should be considered to help maintain personal image and hygiene habits.
7. Cleaning – To remain hygienic, personal hygiene equipment must be easily cleaned, sanitized and maintained.
8. Mission Duration – Shorter missions generally require less extensive personal hygiene facilities. Additional guidelines for determining facility needs are discussed in the following section, Architectural Considerations. For safety and health reasons, hygiene facilities must be designed to accommodate partial-body or full-body cleansing before and/or after these functions:
 - Urination and defecation
 - Exercise
 - Medical activities
 - Experimentation or other work requiring specialized washing
 - Meal consumption
 - Accidental exposure to toxic substances
 - Eye contamination
9. 0-gravity
 - Cleanup – Designs should minimize the time and effort to use hygiene facilities. In 0g, water and debris, such as hair, do not fall to a fixed surface (such as the floor) as they do on Earth. Functions that require relatively little time on Earth, such as a shower, can take considerably longer in 0g. This can have a negative impact on both mission schedule and personal motivation to use the facilities.
 - Restraints – In 0g, restraints should be provided for stabilization of crewmembers in the hygiene area.

Hygiene facilities should also accommodate the hygiene byproducts defined in Table 7.3-1.

Table 7.3-1 Personal Hygiene Byproducts

Hygiene Byproducts	Mass (g/person/day)	Volume (mL/person/day)
Hair growth	0.03 (0.3 to 0.5 mm per day)	
Desquamated epithelium	3	2
Hair – depilation loss	0.03	0.03
Hair – facial – shaving loss	0.3	0.28
Nails	0.01	0.01
Solids in sweat	3	3
Sebaceous excretion – residue	4	4.2
Solids in saliva	0.01	0.01

Water may or may not be part of the body cleansing process. If water is used, hardware design should address:

- Application of the water to hands and face
- Removal of excess water from the body (and the facility or cleansing aids)
- Ability to control the temperature of the water, and its flow and usage

- Preventing water from escaping into the spacecraft environment

Location of hygiene facilities should be based on the following considerations

- Maximum privacy
- Location near personal cabins or areas
- Location far from galley and dining
- Location in low-traffic areas
- Ease of (frequent) access
- Combination with waste management
- Mixed-gender crew

The facility sizing and interior layout should be based on the following features

- Major features: cleansing aids, sink, storage, shower
- Stowage and supplies – brushes, toothbrushes, wipes, hair trimmer, mirror, toothpaste, soap, debris containment
- Body postures, ranges of motion (see Figure 7.3-1)
- Number of crewmembers – having a large number of crewmembers on a spacecraft at the same time may necessitate more than one facility
- Privacy

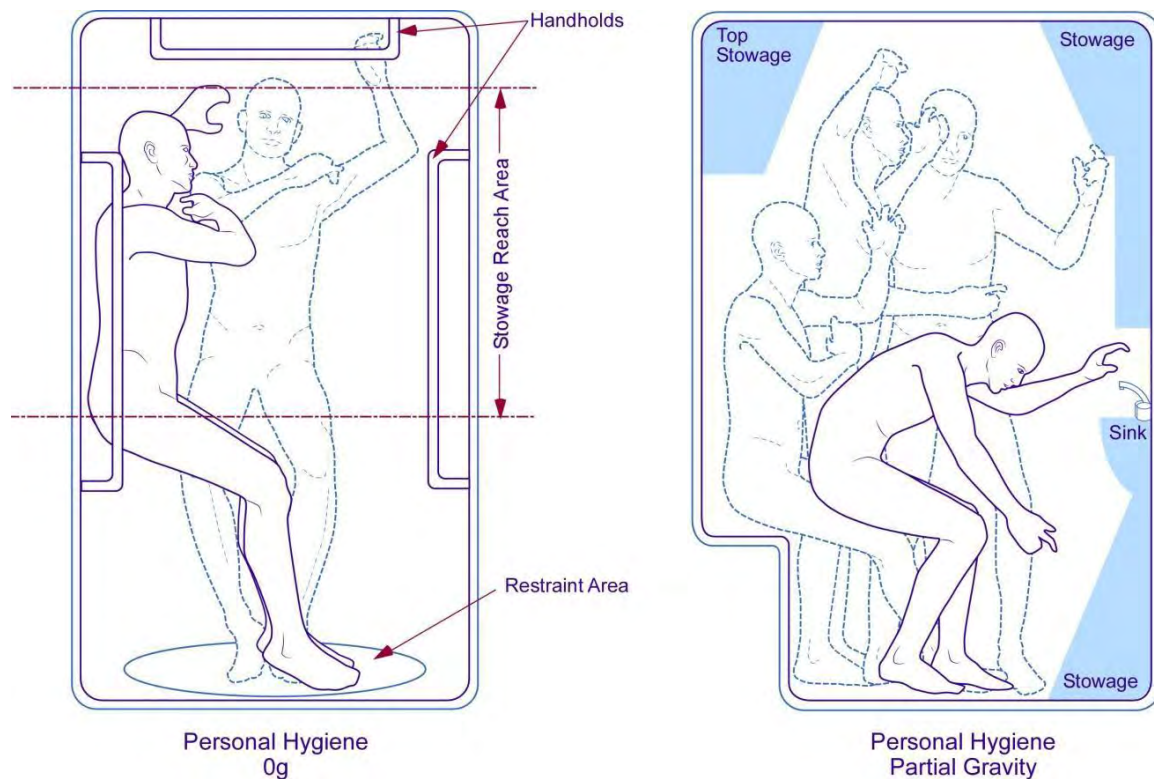


Figure 7.3-1 Personal Hygiene Facility Sizing

A shower was developed for Skylab (Figure 7.3-2), but it required so much crew time to set up and operate that it was judged to be too much trouble to include it in the Space Shuttle. Astronauts would step inside a ring on the floor, raise a fireproof beta-cloth curtain on a hoop, and attach it to the ceiling. A flexible hose with push-button shower nozzle could spray 2.8 liters of water from the personal hygiene tank during each bath. Used water would be vacuumed from

the shower enclosure into a disposable bag and deposited in the waste tank. (link: <http://www.astronautix.com/project/skylab.htm>)



Figure 7.3-2 Skylab Shower

The Russian *Mir* space station had a rigid, water-tight shower that provided 10 liters of water, which was returned to the water reclamation system for later use.

7.3.3 Research Needs

RESERVED

7.4 BODY WASTE MANAGEMENT

7.4.1 Introduction

During space missions, proper elimination and containment of waste, including feces, urine, menses, and vomit, as well as related hygiene are critical considerations. Contamination from body waste can enter the body through the nose, mouth, ears, and cuts in the skin, and can cause a variety of illnesses and infections. This section provides design guidelines for body waste management.

7.4.2 General Considerations

Consider the following in the design of waste management systems:

1. Maintenance – System servicing and repair tasks are neither pleasant nor mission-productive. Therefore, the system should be as reliable as possible and require a minimum of repair time. Scheduled maintenance and servicing times, including unloading and refurbishment, should be kept to a minimum. This includes periodic cleaning to control microbial growth.
2. Ease of Use – The system should be simple and quick to use. The system should be readily available for emergencies such as vomiting or diarrhea. As a design goal, the facilities should be used like and require approximately the same amount of time for use as Earth facilities.
3. Acceptance – The body waste management systems should be both psychologically and physiologically acceptable to the crewmembers. An unacceptable system can result in deliberate restriction or modification of the diet by the crew and possible nutritional deficiencies.
4. Gravity – Gravity plays an important role in the removal of feces from the body during defecation in a 1g environment. A means to assist the removal of feces away from the body should be provided in a 0g environment. Airflow has been used successfully in the past for the entrainment of both feces and urine in 0g. In addition, body restraints must be provided, and should be easily and quickly put in place.
5. Odor – Waste management odor must be minimized.
6. Contamination – The system must prevent fecal contamination of the food system.
7. Privacy – Full-body visual privacy must be provided for waste management activities. To the extent possible, auditory and olfactory privacy should be provided.
8. Supply Stowage – Waste management supplies must be accessible to a crewmember using the waste management system.
9. Post-Defecation Cleansing – In 0g, many more tissues are needed for cleansing the anal areas after defecation, because gravitational forces are not present to aid in separation of the feces from the body. Also, since settling does not occur, the uncompacted wipes occupy 1.5 to 3 times the volume that would be used in a 1g environment.
10. Volume and Mass of Body Waste Products
 - The waste management system must be capable of collecting and containing an average of 150 grams (by mass) and 150 mL (by volume) of fecal matter per crewmember per defecation at an average two defecations per day. The normal feces

bolus of a healthy adult varies in size from 100 to 200 mm long by 15 to 40 mm in diameter and weighs 100 to 200 grams. The number of defecations per day is individually variable, ranging from two times per week to five times per day, with an average of two times per day being assumed for design purposes. The waste management system must be capable of collecting and containing 500 grams (by mass) and 500 mL (by volume) of fecal matter per crewmember in a single defecation. This is based on the maximum fecal output for an average healthy adult.

- The waste management system must be capable of collecting and containing 1.5 L of diarrhea in a single event; 1.5 L is based on evaluations of individuals afflicted with pathogenic diarrhea, as found in medical literature, and based on most likely maximal discharge in afflicted individuals. A crewmember could experience up to eight diarrhea events (average volume of 0.5 L each) per day for up to 2 days, which must be accommodated. From a waste management system standpoint, normal feces should not be accounted for on days when a crewmember is afflicted with diarrhea.
- The waste management system must be capable of collecting and containing a maximum total urine output volume of:

$$V_U = 3 + 2t$$

liters per crewmember, where t is the mission length in days. Urine production on the first day after launch is 3 liters per crewmember. Urine output may be slightly greater or less in different phases of the mission (associated with g -transitions) and with different fluid intake levels. There must be the capability to collect all of the crewmember's urine output in succession, with an average void varying from 100 to 500 mL. Rarely, a single void might be as much as 1 liter, so the equipment must be able to accommodate this maximum. In addition, the capability must exist to collect 1 liter of urine per crewmember per hour. The rate of urinary delivery into the system from the body will vary by gender (greater for females because of lower urethral resistance) but averages 10 to 35 mL/s. Maximum flow rate with abdominal straining in a female may be as high as 50 mL/s for a few seconds, and must be accommodated. The number of urinations per day is individually variable, with an average of six times per day, which must be accommodated.

- The waste management system must be capable of collecting and containing vomitus for up to 8 events of an average of 500 mL each. The maximum volume of expelled vomitus can be 1 L of solids and fluids, with a fully distended stomach. The average volume of vomitus is more likely to be 200 to 500 mL.
- Other waste products are defined in Table 7.4-1.

Table 7.4-1 Waste Products

WASTE PRODUCTS	MASS (g/person/day)	VOLUME (mL/person/day)
Mucus	0.4	0.4
Menses (see note 1)	113.4	113.4
Flatus as gas	–	2000
Solids in feces	20	19
Water in feces	100	100
Solid in urine	70	66
Water in urine (note 2)	1630	1630

Notes:

1. Approximately once every 26 to 34 days and lasting 4 to 6 days, approximately 80% released during first 3 days.
2. Based on Skylab data

11. Anatomical Considerations – Dimensions of the body that should be considered for design of waste management facilities are shown in Table 7.4-2 and Figure 7.4-1. The body protuberances of the pelvis, the ischial tuberosities, support the seated body in 1g conditions. In reduced-gravity conditions, seat contours and restraints can help the crewmember locate the ischial tuberosities and thereby properly position the anus and urethra in relation to the collection devices. If airflow is used for collection and entrainment of feces and urine, it may be necessary to minimize the size of the air duct or collector opening for sealing. In both 1g and 0g conditions, it is possible to defecate through a 10-cm-diameter opening, although significant problems have been noted with this small opening. Differences in male and female anatomy should also be considered.

Table 7.4-2 Anatomical Dimensions for the Design of Body Waste Management Facilities

Description	Dimension	Dimension Range (cm)	
		Male	Female
A	Lateral separation of ischial tuberosity	10 to 14	11 to 16
B	Width of perineal furrow	7.5 to 9	7.5 to 9
C	Anterior and posterior separation between tuberosities and exterior urethral opening	13 to 27	6 to 9
D	Anterior and posterior separation between anus and external urethral opening	15 to 30.5	9 to 11.5

12. Body Posture – Since the act of defecation involves the use of stomach muscles, the ability for the body to be positioned so that these muscles are supported and not strained, such as in a sitting position, must be provided. There is no evidence to suggest that posture has any effect on facilitating urination.
13. Simultaneous Urination and Defecation – The ability must exist to allow a crewmember to urinate and defecate simultaneously. This is to ensure that there is no accidental discharge of one or both waste components into the habitable volume, since it may be difficult to relax the gastrointestinal control sphincter without relaxing the urinary

voluntary control sphincter, and vice versa. To minimize impact to crew operations, waste elimination should be accomplished without having to completely remove clothing.

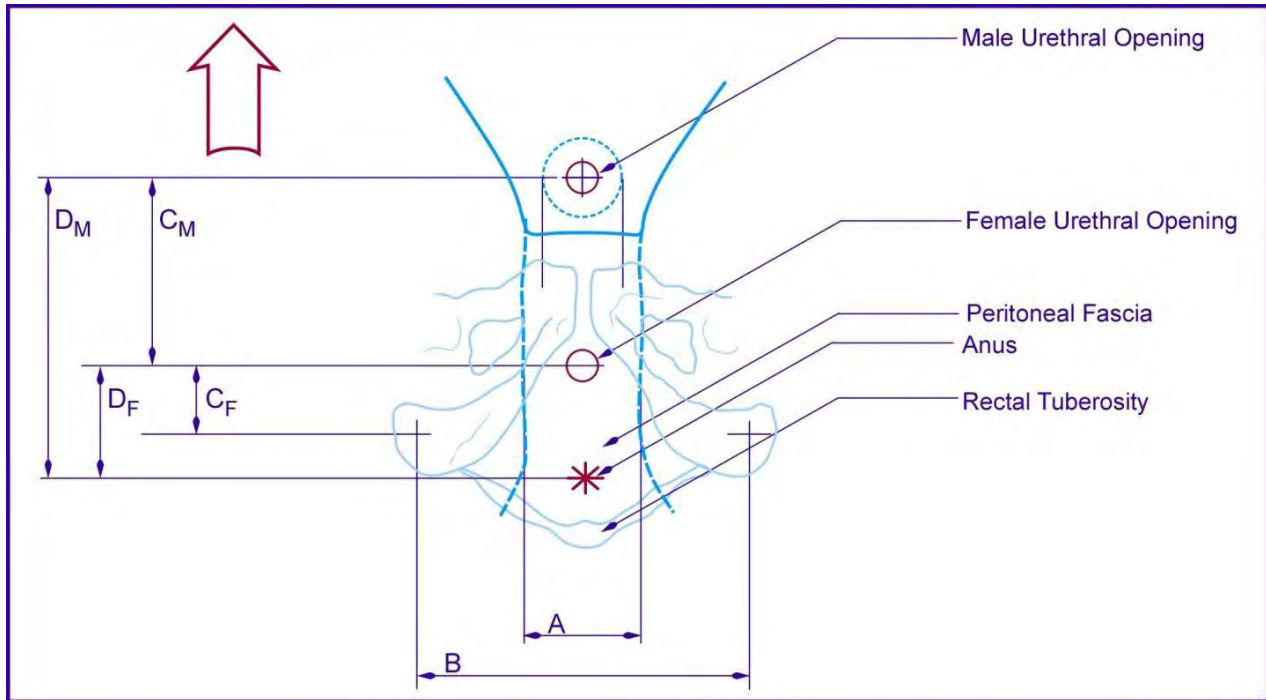


Figure 7.4-1 Anatomical Dimensions for the Design of Body Waste Management Facilities

Location of waste management facilities should be based on the following considerations

- Maximum visual and auditory privacy
- Location near personal cabins or areas
- Location far from eating and food preparation areas
- Location in low-traffic areas
- Ease of (frequent) access
- Combination with personal hygiene activities
- Mixed-gender crew

The facility sizing and interior layout should be based on the following features

- Major features: toilet, urinal, restraints
- Stowage and supplies – wipes, trash
- Body postures and ranges of motion
- Number of crewmembers – having a large number of crewmembers on a spacecraft at the same time may necessitate more than one facility
- Privacy

7.4.3 Research Needs

RESERVED

7.5 EXERCISE COUNTERMEASURES

7.5.1 Introduction

To ensure that crewmembers can perform nominal tasks (including EVAs), be able to function when returning to 1g environments, function during off-nominal events such as emergency landings, and provide for long-term quality of life, the crew needs to maintain an appropriate level of physical fitness throughout the mission. Countermeasures may be physical (i.e., exercise with or without mechanical devices), chemical (i.e., pharmacological interventions, diet), or a combination of the two. This discussion focuses on physical exercise countermeasures.

Most of the physiological-related concerns (such as decreased cardiovascular fitness and musculoskeletal function) can be mitigated via usage of exercise equipment, as described in section 5.2 Physical Workload. Maintaining cardiovascular fitness and musculoskeletal strength via use of countermeasures during flight are vital to crew health and productivity during the missions and upon return to 1g.

To meet the physical fitness needs of a given mission, a spacecraft needs to be able to accommodate the physical equipment, resource demands, and crewmember volume (including range of motion). Mission durations longer than 30-60 days are expected to require similar degrees of exercise countermeasures, as currently required within the ISS Program (ISS Flight Rule B13-113). Shorter missions are expected to require less-stringent countermeasures due to a reduced exposure to <1g environments. This section addresses the physiologically driven performance needs and equipment and vehicle design considerations, including volume, placement, structural systems, environmental controls, power interfaces, software and data systems, and reliability.

7.5.2 Mission Concept Planning Considerations

To effectively plan for the types and number of equipment needed, the overall mission concept needs to be defined. The number of crewmembers, number of shifts, mission duration, crew population variations, fitness-level drivers, and possibly unique crewmember needs should be taken into account to determine the types, locations, and quantities of equipment needed.

7.5.2.1 Quantity of Equipment

The types and quantities of exercise devices required to effectively provide the necessary countermeasures can be determined by assessing various mission-specific parameters (e.g., number of crewmembers, number of crew shifts, physiological performance needs).

7.5.2.2 Mission Fitness Level

To determine the physical fitness needs of a mission, the mission environment (i.e., 0g or planetary surface) and tasks needs to be understood. Then, proper countermeasures can be defined within the constraints of the mission and spacecraft.

1. Gravity environment – The gravity level and duration of exposure affect the extent and rate of physiological adaptation to that environment. Missions may include several gravity

environments, starting with 1g on Earth, hyper-g during launch and entry, 0g in LEO, and 1/6g on the Moon – all of which will affect physiological adaptation and, potentially, human performance, differently.

2. Mission tasks – Some missions may include tasks that require a greater physical workload than others (e.g., EVA) or are performed at unique phases of the mission (e.g., landing). The physical requirements of tasks through the mission should drive the crew fitness level. For example, because hand mobility in a pressure suit is strenuous, EVA crewmembers tend to put more emphasis on increasing hand and forearm strength before a mission.

7.5.2.3 Exercise Scheduling

The scheduling requirement for each crewmember on the ISS is 1 hour for aerobic exercise and 1.5 hours for resistive exercise for a total of 2.5 hours per crewmember per day (see section 7.5.4.1 for further details).

Exercise scheduling is determined by a number of factors (e.g., number and types of functional device, length of crew day, and number of crewmembers requiring each type of device). There are also scheduling constraints that limit when and how exercise can be scheduled (e.g., post-meal, no-exercise periods).

If a mission day consisted of multiple crew shifts, there could potentially be a decrease in the number of exercise devices needed at any given point in the day. As a result, a smaller number of exercise devices may be required on the spacecraft.

7.5.3 Physiological Drivers & Performance Needs

The physiological concerns that may be mitigated by exercise (see HIDH Chapter 5) drive the performance requirements of the exercise hardware provided. This section provides a description of those concerns.

Proper nutrition and hydration are also important for physical fitness, and must be provided. Not only does the body need additional energy to perform exercise, but this fuel must include the proper balance of carbohydrates, protein, and fats (see section 7.2 Food and Nutrition). Moreover, additional water is needed to counteract the dehydration that naturally occurs during exercise (see HIDH Chapter 6.3, Water).

7.5.3.1 Aerobic Capacity

To maintain cardiovascular fitness, the cardiovascular system must be sufficiently stressed throughout a mission. Knowledge of each crewmember's preflight VO_2 Max and heart rate are critical for writing in-flight exercise prescriptions designed to properly stress the cardiovascular system. Intensity, frequency, and duration of the prescribed exercises need to be considered when attempting to maintain values that are essential to performance during nominal tasks and to provide additional reserve in case of emergency or off-nominal operations of the crew.

As covered in HIDH Chapter 5.2.2.1, 5.2.3.1, 5.2.4.1, maintaining the aerobic system supports the crew's overall health and ability to work without fatigue.

The efficacy of the aerobic activity depends on the duration, intensity, and intervals during exercise, with intensity being the most important factor (as identified in ongoing research).

7.5.3.2 Musculature System

As covered in HIDH Chapter 4.7 and 5.2.3.2, preserving and maintaining the musculature system is important not only for proper metabolism, but also for preserving strength for planned tasks throughout the mission.

Resistive exercise relies on the body to work against its own, or an externally provided, force (weight). In 1g (on Earth), that force is provided by gravity. However, in 0g the notion of weight is meaningless, and mechanical resistance or an external loading mechanism must be provided. In partial-g, gravity may be used to provide some of the required resistance, which can off-load the exercise device design. On Earth, the American College of Sports Medicine recommends exercise regimens for individuals. These recommendations may differ in 0g, although exactly how they may differ remains a point of ongoing research. In microgravity, the counterforces necessary to properly stress the muscles include not only the forces required to aid in muscle growth or maintenance, but also the forces needed to offset the now-weightless mass of the crew. For example, a squat of 100 lbs (45 kg) on Earth equivalent would need to be 100 lbs (45 kg) plus the person's body weight on-orbit. On-orbit resistive exercise has mirrored ground-based resistive exercise activities, requiring movements against loading such as squats, heel raises, and dead lifts.

In addition to the maximum loading capability, the variation of how the load is applied for any given exercise is also critical to providing effective resistive exercise. The optimal ratio of eccentric to concentric loading is approximately 1, or slightly greater. A concentric contraction is a type of muscle contraction in which the muscles shorten while generating a force. During an eccentric contraction, the muscle elongates while under tension due to an opposing force being greater than the force generated by the muscle (see HIDH Chapter 5.2 for more information).

7.5.3.3 Skeletal System (Bone Loss)

Bone loss has been found to be one of the more significant risks of spaceflight. Maintaining the skeletal system and preventing bone loss (see NASA STD 3001 Vol 1 section 4.2.9 and F. 7, and HIDH Section 5.2.4.) is critical to protecting the crew's health. Observations show that when the internal bone matrix is rebuilt, it is rebuilt with a lower density during spaceflight. Although research continues to identify the best bone loss prevention approaches, ground reaction forces (the force exerted by the ground on a body in contact with it) and high loading during resistive exercise are believed to contribute the most to mitigate bone loss.

7.5.3.4 Sensorimotor System

Maintaining the sensorimotor system (see NASA STD 3001 Vol 1 section 4.2.4 and Vol 2 section 5.1.3. and SP-2010-3407 Section 5.3) has been demonstrated to be important to perform tasks safely and effectively. Due to the differences of locomotion and activities in space and the effects of 0g on the inner ear, physical coordination and responses have been shown to require adaptation time during transitions between different gravitational environments. To minimize that adaptation time, activities that stress balance, vestibulospinal reflexes, and vestibulo-ocular reflexes would be useful mitigations.

For example, treadmill usage has been identified as a mitigation to balance and locomotion deficits after returning from long-duration missions.

7.5.3.5 Decompression Sickness (DCS) Prevention

The approach to preventing DCS (see section 6.2.2.1.1) is by flushing the circulatory system of nitrogen. Prior to EVAs, one method used to minimize the risk of DCS was having the crew combine aerobic exercise with breathing a high partial pressure of oxygen (ppO₂) air mixture prior to entering a lower-pressure environment.

7.5.3.6 Psychological Support

Reserved (See NASA STD 3001, Volume 1 Section 4.4.3.5 and Volume 2 Section 8.1.4)

7.5.4 Vehicle and Operational Resource Considerations

Accommodating exercise capability is expected to drive vehicle design. Conversely, spacecraft vehicle resource capability should be taken into account when planning for specific exercise equipment designs and operational functions so as to fit within the mass and volume constraints.

Based on the physiological drivers, exercise equipment has been selected to provide the most comprehensive capabilities that function best for the crew health and mission concepts within the given vehicle's resources. Experience has shown that if exercise equipment, operational space, environmental controls, and support hardware are not planned into the vehicle design, then the capability to provide exercise (e.g., functional capabilities and volume for range of motion) is compromised.

7.5.4.1 Operational Time, Usage, and Placement

Scheduled exercise sessions should include time for setup, preparation, exercise protocol, clean up, and stowage of the hardware. To increase efficiency of exercise time, equipment should be designed to minimize access time, initialization time (hardware, software, crew adjustments) and shutdown/standby and restow times. Based on ISS experience, for missions longer than 30-60 days, approximately 2.5 hours, per crewmember, will be allocated daily for exercise, divided into 1.5-hour and 1.0-hour blocks for aerobic and resistive exercise, respectively. Each of these blocks will include time (~30 minutes each) for preparation, setup, stowage, and clean-up activities based on ISS experience.

Location of the hardware within the spacecraft affects when it can be used. The physical operational envelope of the hardware may impinge on higher priority adjacent activities. Use of exercise hardware may also block crew and equipment translation through a section of the spacecraft – e.g., Advanced Resistive Exercise Device (ARED), Cycle Ergometer with Vibration Isolation and Stabilization (CEVIS), and Treadmill 2 (T2) within the ISS – and scheduling of these devices must be deconflicted with any crew translational needs. The use of exercise hardware may also be limited by a number of other constraints, including vehicle acceleration activities and vibration loads limitations.

While exercise may be possible in many locations, some locations are more favorable than others because of their location within the overall vehicle:

- Depending on the exercise device, there may be limits of use due to vehicle acceleration activities.

- Areas where exercise occurs must properly control the increased heat, carbon dioxide production, and humidity that result from exercise (see section 6.2.3.1.4 Expected Metabolic Loads).
- The ppO₂ in the exercise area(s) must be maintained at normal levels; otherwise, the required physiological capabilities of crewmembers may be impaired (see section 6.2.3.1.4 Expected Metabolic Loads).
- Because of body odor and the possibility for contamination with sweat, exercise should be performed as far from food preparation and eating areas as possible, or other methods of contamination protection should be used, such as a physical barrier.
- If exercising creates substantial noise because of exercise performance, exercise hardware, or environmental controls, it should not be done near sleeping or communication areas. If it has to be done near those areas, then exercise must not be done while crewmembers are performing those activities.
- Because exercise and related equipment may take up substantial volume, exercise areas should be located so that they minimize interference with translation paths and other tasks. To minimize impacts to operations, the equipment should be located in a low-use, low-traffic area.
- Due to medical privacy considerations, exercise equipment should be located out of view of any standard, public videoconferencing views.

Depending on the spacecraft size and layout, it is possible that exercise can be accommodated only in certain locations. If there are multiple possible locations to perform exercise, it may be most practical to choose one location for all or most exercise so as to minimize operational interferences, focus environmental controls, and design for vehicle structural loads. ISS crewmembers have reported issues related to the co-location of exercise activities with other activities such as dining and sleeping.

7.5.4.2 Volume

The volume required for any given exercise equipment is typically broken into three categories: Operational volume (including crew movement and deployed hardware), installed volume (hardware below the deck of the vehicle), and stowage volume (e.g., accessories, maintenance kits, etc.) – all of which should be planned for in the vehicle design.

The operational volume typically includes the space required for the movement of the person, along with the space for the deployed volume of the equipment. While the spacecraft is in 0g, this volume's minimum dimensions may occur in any orientation; when it is in a gravity field, such as on the Moon or Mars, these dimensions should take the “upright” orientation of the person into account. ISS installed and operational volume (not including stowage) for the exercise equipment requires approximately 24 m³. Table 7.5-1 provides example exercise volumes for each type of device.

**Table 7.5-1 Example Exercise Volumes
(Representative hardware volumes taken from ISS equipment)**

	Treadmill-type Exercise & Equipment	Resistive-type Exercise & Equipment	Cycle and Rowing Ergometry-type Exercise & Equipment
Crew Movement & Psychological* Space Operational Dimensions (m)	2.3 H x 1.0 W x 1.8 D (including dynamic movement)	2.3 H x 2.3 W x 1.8 D	2.0 H x 1.5 W x 1.3 D
Crew Movement & Psychological Space Operational Volume (m ³)	4.1	9.1	3.9
Deployed Hardware Operational Volume (m ³)	0.4	10.2	4.2
Installed Volume Range (m ³)	0.6 – 2.8	N/A for ISS	N/A for ISS
Stowed Volume Range (m ³)	TBD	TBD	TBD
Total Volume Ranges (m ³)	>5.3 – 7.5	>11.6**	>4.4 (accounting for overlap of crew movement and deployed hardware volumes)

*Note: Psychological Volume is the empty space needed by the crewmember to perform exercise – i.e., no obstruction at face-level, etc.

**Total volume taken from ARED operational volume. ARED operational volume does not account for full width of crew movement space.

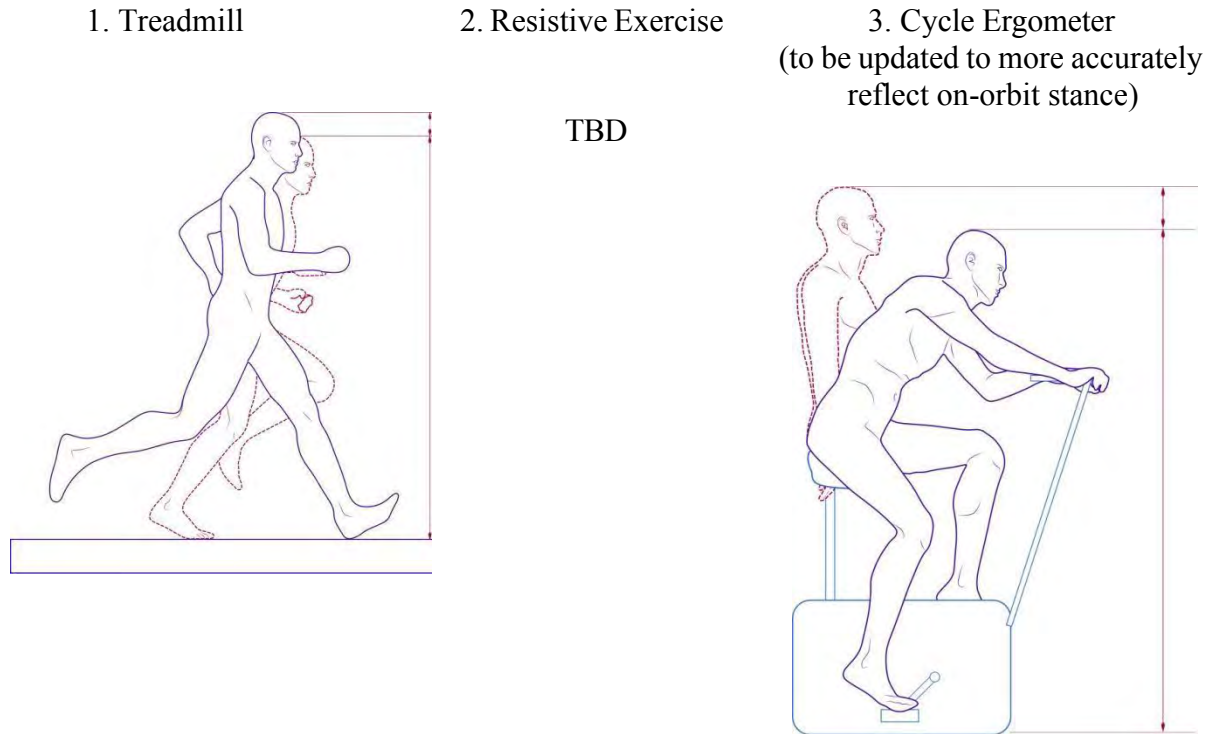


Figure 7.5-1 Crew movement operational envelope height.

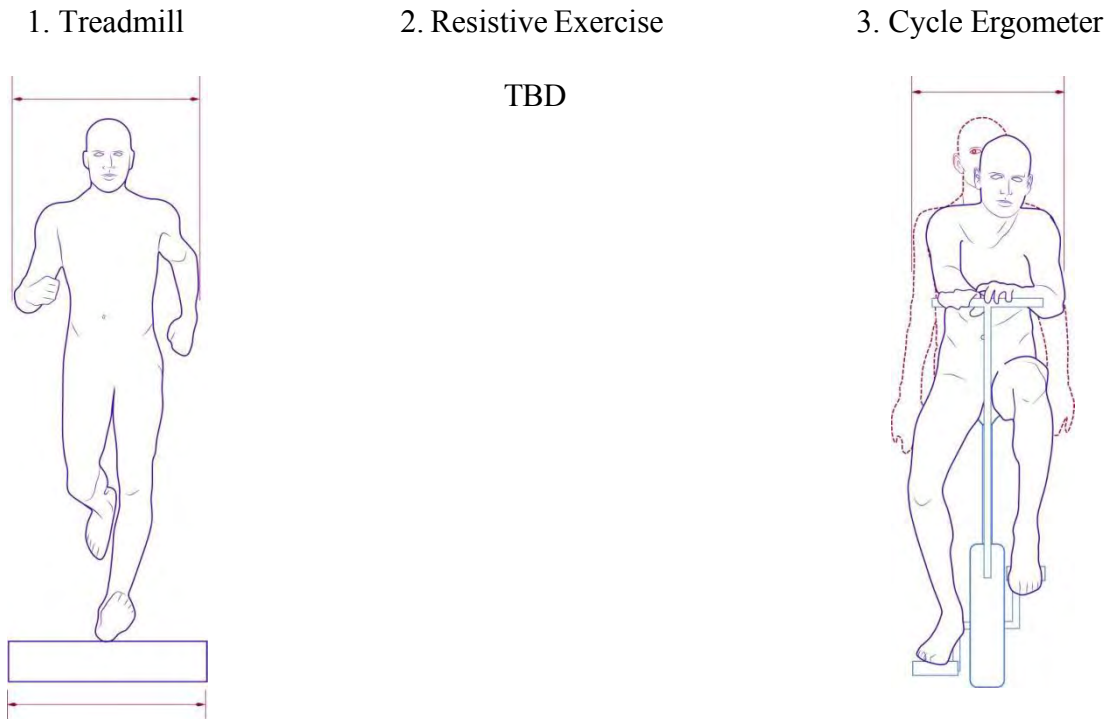


Figure 7.5-2 Crew movement operational envelope width.

For the crew movement operational exercise envelope, the following apply to the head-to-toe or “height” orientation:

- If the exercise requires jumping or a running motion, such as a treadmill, then the maximum crew jumping or running height must be accommodated. This also depends on

the gravity environment (the lower the gravity, the higher the jumping height), any movement in a vibration isolation system, and any restraint system that may limit motion.

For the crew movement operational exercise envelope, the following apply to the back-to-chest or “depth” and shoulder-to-shoulder or “width” orientations:

- If the exercise requires bending at the waist, reaching forward or sideways with the arms, or extending the legs forward or sideways, those dimensions must be accommodated.
- Instead of providing a volume to encompass all motions, it may be possible to constrain some dimensions by turning the body during exercise. For example, if one exercise requires a forward reach, and another requires a sideways reach, it may be possible to have the crewmember turn the body 90 degrees (in yaw) between exercises, instead of providing room for both a forward and a sideways reach.
- The variations of stride length and location over the hardware over time should also be accommodated.

Dynamic movement of the vibration isolation system (or mounting system) should also be included in addition to the dynamic movement of the person during exercise as part of the overall operational movement.

The deployed operational volume is the volume of the hardware that protrudes above the deck into the general crew operational environment. Deployed equipment hardware volume is included in the overall operational volume.

The installed volume encompasses only the volume of the hardware below the deck of the operational environment.

The installed and deployed volumes tend to encompass:

- Primary exercise device
- Crew stabilization hardware (e.g., handrails, benches, etc.)
- Control panels (e.g., laptop)
- Crew monitoring equipment (e.g., heart rate monitors, etc.)
- Vibration Isolation System or Mounting System

The stowed volume encompasses the volume required for supporting components that are not permanently affixed to the vehicle structure and may or may not be required to be co-located with the exercise equipment. Stowage volume tends to vary over the course of a mission due to usage and resupply rates. The stowage volume required for exercise equipment typically includes:

- Maintenance equipment (e.g., unique tools, calibration equipment, and cleaning materials)
- Additional exercise components (e.g., bars, handles, straps, clips, harnesses, ropes, bungee cords, support rails, computer interfaces)
- Personal equipment (e.g., shoes, exercise clothes)
- Contingency spares

Total volume for the exercise equipment incorporates the operational volume (with both the crew space and deployed hardware), installed volume, and stowage volume.

7.5.4.3 Mass

The mass for exercise equipment is often driven by structural strength, vibration isolation requirements, and the physics required to impart the type and frequency of loads on the crew. One method to minimize the complexity of a vibration isolation system is to add mass. The highest mass exercise equipment on ISS (2,350 lbs [1,066 kg]) was driven by the need to isolate and offset the loads imparted by a runner to minimize vibration in a limited space.

7.5.4.4 Mounting and Structural System

In any spacecraft, exercise may require a vibration isolation system, which will need to be mounted between the exercise device and structure to prevent inadvertent contact with the surroundings during exercise. Depending on the type of exercise and the need for maintaining a quiescent environment, a vibration isolation system may also be needed to prevent transmission of exercise movement vibration and loads into the spacecraft. Either the vehicle will need to be designed to support the mass movement and loads required by exercise, or will need to include space and mass for vibration isolation systems to minimize loads from being imparted into the structure. Vibration isolation systems may be passive or active, and the design is often driven by the amount of isolation required by the vehicle and the type of exercises being performed.

Another factor of location is the resonance of the structure with the vibrations created by the exercising crewmember. Depending on the vehicle design, placement of the exercise equipment can be critical to avoid imparting significant loads into the vehicle structure. Certain locations may not be usable due to coupling of the frequency of the exercise to the natural frequency of the structure. As the vehicle structure changes over time, the natural frequencies can also change. Likewise, it may be necessary to “de-tune” any vibrations by not operating the equipment at certain frequencies. For instance, there may be a speed range on a treadmill or cadence on a resistive exercise device that is not allowed, due to such factors.

7.5.4.5 Localized Environmental Controls

Due to the effects of exercise, controls to provide sufficient ppO_2 , remove carbon dioxide, maintain proper humidity levels, provide airflow, maximize heat rejection, and minimize odors should be included in planning for the exercise device location. (See NASA STD 3001 Vol 2 section 7.4.4. and HIDH chapter 6.2.3.1.4 Expected Metabolic Loads)

7.5.4.6 Power Systems

Depending on the type of exercise devices used, typically some level of power is required – if only to transmit the data on how the device is used. In addition, based on the number of users, frequency of use, or perceived inconvenience of power cycling the hardware, the crew may choose to leave the hardware continually powered. Although resistive equipment technology historically has required minimal power usage, motorized treadmills historically have required the most power during usage (between 900 – 2400 W).

If exercise concepts include power generation, then coordination with the vehicle power subsystems should be planned during development.

7.5.4.7 Software and Data Systems

To monitor crew health, collect medical data, and monitor the equipment health (see NASA STD 3001 Vol 1 section 4.4.3.1., 4.4.2.6.2, 4.4.3.10.1, 4.4.3.10.2, and Vol 2 section 10.1.6.1), some type of electronic data system and display is typically integrated into the exercise equipment. For further discussion on displays, see HIDH Chapter 10, Crew Interfaces.

The design of the displays should include planning for the motion of the crewmember during usage (e.g., designing button locations to allow for a running crewmember to easily select without stopping.).

7.5.4.8 Reliability and Maintenance

Depending on the duration of the mission, the criticality of exercise equipment, and accessibility to repair and resupply, reliability becomes a significant factor. If possible, design the equipment to fail operable (even if at a limited capability).

Exercise equipment may require regular maintenance. The type and frequency of the maintenance is dependent on the type of machine, frequency of usage, and how it is used. Regular maintenance on the equipment should be designed to be as minimal as possible.

7.5.5 Previous Types of Spaceflight Exercise Equipment

Exercise devices typically mitigate more than one of the physiological drivers (e.g., cardiovascular, bone, and muscle); however, most devices are best suited to address one system over the other.

7.5.5.1 Treadmills

Treadmills primarily address the cardiovascular system (aerobic fitness). Six treadmill designs have been or are being used in space.

The first spaceflight treadmill was developed for Skylab 4 to mitigate aerobic deconditioning and fluid volume loss. The treadmill design was a Teflon[®]-coated aluminum walking surface attached to the iso-grid floor with a bungee-harness system capable of applying an external load of 176 lbs (80 kg). Locomotion was similar to walking up a slippery hill, which caused premature muscle fatigue and thus could not be practiced for a significant duration.

NASA/Mir utilized the treadmill, BD-1, located in Core Module.

The next-generation United States Operational Segment (USOS) treadmill was non-motorized (a crewmember was required to actively move the belt) and crewmembers were tethered to the treadmill with a bungee-harness system. This treadmill was used only for experimental purposes on Space Shuttle missions.

The first ISS treadmill, Treadmill with Vibration Isolation Stabilization (TVIS), aboard the ISS is mounted to an active and motorized vibration isolation system; therefore, the treadmill can be used in either the active (up to 10 mph) or the passive mode with the powered VIS. TVIS was provided as one of the earlier ISS exercise devices, and was designed to work with limited power and volume.

The Russians flew a modified BD-1, which was similar to the NASA/Mir passive design and was meant to be mounted on the isolation system of the TVIS in a contingency scenario; however, BD-1 did not need to be installed.

A second USOS treadmill was produced and flown to support the increase to a 6-person crew. At that time, TVIS usage was allocated to the Russians crewmembers. The second-generation ISS treadmill (T2) combined a slightly modified, commercially designed Woodway treadmill with a standard Boeing International Standard Payload Rack, and a customized vibration isolation system. Crewmembers are able to run at a speed of up to 12 mph. Due to the passive vibration isolation system limitations, the minimum speed allowed is approximately 3 mph. The T2 treadmill also has a wider tread surface and increased programmability for exercise prescriptions.

The Russians are preparing BD-2, which is meant to replace TVIS as the Russian treadmill.

7.5.5.2 Cycle Ergometers

Cycle ergometry was introduced in an attempt to maintain aerobic fitness. Cycle ergometers have been used by Space Shuttle crews and long-duration ISS crewmembers and have successfully reduced losses in aerobic capacity. Crew preferences for aerobic exercise vary by individual between the cycle ergometers and the treadmills.

The Space Shuttle Cycle Ergometer (SCE) was hard-mounted directly to the Space Shuttle, was designed to adjust in 25 W increments, and provided no data-recording capability.

The cycle ergometer aboard the ISS (CEVIS) is designed to allow 1 W incremental adjustments, has a computer interface for operational protocols and data recording, and is mounted using a passive vibration isolation system along with counter-throw masses for stabilization.

The Russian cycle ergometer (VELO) has the ability to adjust workload in 25 W increments.

7.5.5.3 Resistive Exercise Devices

To maintain a given level of bone mineral density and muscular strength, it is important to have all three forms of muscle contraction (concentric, eccentric, isometric) in a strength-training program. Musculoskeletal fitness is necessary to complete mission-critical and EVA-related tasks (e.g., moving large items during planetary EVAs, egress after landing). It is also important for overcoming the inherent resistance in any spacesuit.

Resistance training, which stresses the muscles and bones, is needed to maintain musculoskeletal fitness. Intensity, frequency, and duration will have an impact on how much muscle mass and strength and bone mineral density is preserved. In 1g, a person's body weight can provide adequate resistance to maintain bone and muscle, with everyday activities and exercises such as squats, push-ups, and sit-ups. While

likely not adequate resistance, the 1/6- and 3/8-effective body weight on the Moon and Mars, respectively, should be taken into consideration in exercise device design.

Exercise countermeasures have been used since the Gemini program and have changed and improved to suit different mission durations, operational constraints, and device efficacy. In response to the decreased exercise tolerance and muscle atrophy experienced by the crewmembers after they used a friction-based concentric device, the Exer-Genie, during the Apollo Program, (Dietlein, et al., 1975) arm ergometry was practiced on Skylab 2. The arm ergometer did not protect against losses in lower-body muscle strength.

The MK1 and MK2 (“Mini-gym”) were subsequently developed for use on Skylab 3. The MK1 and MK2 provided traditional rowing capabilities for aerobic conditioning and had accessories for anaerobic resistive exercises. Decrements in muscle strength and mass were observed after Skylab 3 (Thornton, et al, 1977).

ISS resistance exercise protocols intended to maintain muscular strength include upper- and lower-body exercises 6 days per week.

The Contingency Resistive Exercise System (CRES) used bundles of bungees to provide resistance for exercising. The responses provided were that the bungees did not load evenly or with enough loading to provide the desired exercise capability, and they were made available as a contingency device.

Russian cosmonauts have used passive exercise devices. One such device was the “Penguin” suit, which provides passive stress to large muscles by opposing movement. While it is believed to have been beneficial, its benefits have been difficult to measure because the integrated bungee straps are not calibrated, and each suit is adjusted by the individual for comfort.

The interim resistive exercise device (iRED) was introduced for use on the ISS. The device provided adjustable levels of mechanical resistance up to 300 lbs via two canisters with rubber flex packs. The 300-lb limitation and eccentric:concentric loading ratio was found to be insufficient for all the crewmembers’ needs. The crewmember was held to the iRED platform linked to the canisters via a cord-harness system. Both the canister cords and the rubber flexpacks required regular replacement based on the number of cycles used. iRED was directly mounted to the ISS during usage, which transmitted the loads from exercise into the station. During usage, harmonic frequencies were found to line up with the standard exercise frequency, thereby requiring the users to adjust their exercise cadence to avoid causing harm to the vehicle.

Ground-based studies with other in-flight resistive exercise devices (e.g., ARED) show that they are able to provide a greater load and thus may be a more effective countermeasure.

ARED provides the ability to perform a broad spectrum of 35 resistive exercises using the lift bar or cable system. Resistance is provided via vacuum cylinders that can apply up to 600 lbs of resistance for bar exercises and up to 150 lbs of resistance for cable exercises. The crewmember secures himself or herself via the counterpressure between the ARED platform and crew interface (e.g., the loaded lift bar or cable hand grips). Since air pressure against a vacuum is used to create the resistive force, a lower spacecraft total pressure would result in a proportional reduction in exercise resistance. ARED is incorporated into its passive vibration isolation system, which dampens the movement in 3 dimensions (2 translational and 1 rotational).

(Reserved - Insert Force Loader (HC-1) description here.)

7.5.5.4 Other Exercise Devices

(Reserved – insert Russian Chibis restrictive suit description here.)

(Reserved – Insert Space Shuttle Rower description here.)

Table 7.5-2 Spaceflight Exercise Devices (Rucker, 2004)

Exercise	Program							
	Gemini	Apollo	Skylab 2	Skylab 3	Skylab 4	STS	Mir	ISS
Isometrics	X	Exer-Genie			X			
Resistance	Bungees		MK I	MK I MK II	MK I MK II		Penguin Suit*, Bungees	iRED, ARED, Penguin Suit*
Cycle Ergometer			X	X	X	X	Velo	CEVIS, VELO*
Treadmill					Teflon®	X	UKTF-2	TVIS*, T2, BD-1*
Rower			MK I	MK I MK II	MK I MK II	X		

* Russian Systems

7.5.5.5 Non-Exercise Countermeasure Devices

Although not strictly an exercise device, the Lower Body Negative Pressure vacuum suit used on *Mir* provided lower-body negative pressure, which worked by providing a load on the heart and, in conjunction with fluid loading, by restoring some of the fluid volume lost during the mission to improve orthostatic tolerance on return to Earth.

(Reserved - Insert Bracelet description here.)

(Reserved - Insert Kentavr description here.)

7.5.6 Research Needs

Develop countermeasures and technologies to monitor, prevent, and mitigate adverse outcomes of human health and performance risks relevant to:

- impaired performance due to reduced muscle mass, strength, and endurance
- bone fracture
- reduced physical performance due to decreased aerobic capacity
- impaired ability to maintain control of spacecraft and other complex systems

7.6 MEDICAL

7.6.1 Introduction

This section addresses the design and layout of a medical area in a spacecraft, including the overall size, medical interfaces, and stowage. The medical area must support capabilities for health monitoring and for diagnosis and treatment of illness and injury.

7.6.2 General Considerations

The mission duration, trajectory (i.e., LEO, lunar, Mars), and environment are key considerations for determining the type of medical diagnosis and treatment capabilities to be used on a spacecraft. The likelihood of specific injuries, the level of risk, and the feasibility of treatment needs to be defined to understand the medical capability that will be needed on a mission. A concept of operations for a specific mission will help to determine the capabilities needed to support expected illness and injuries. The Spaceflight Human Systems Standard, NASA-STD-3001, Volume 1, outlines the Levels of Care that must be provided for spaceflight.

Many health risks can be anticipated and, therefore, prevented or easily treated during flight. Cuts, bruises, and minor infections require minimal equipment and training to treat. However, emergency medical scenarios are unpredictable and difficult to treat, possibly requiring advanced medical equipment and training, which may not be feasible during flight. Treatment for medical conditions on the Space Shuttle or ISS relies on the ability to communicate with experts on the ground, and return to Earth if necessary. However, for exploration missions, return time to Earth and communications delays will greatly reduce the ability to rely on involvement of Earth-based personnel, and so the crew needs to be capable of performing the majority of medical activities independently. Therefore, the health management infrastructure should also support autonomous medical care and crew health for duty; i.e., have the capability to provide care and maintain fitness for duty during a mission with little or no real-time support from Earth.

7.6.3 Size and Layout

The size of a dedicated medical area, or area capable of supporting medical activities, depends on the number of crewmembers, mission duration, crew activities, and the likelihood that multiple crewmembers may become injured or ill enough to require simultaneous medical attention. At a minimum, the medical system must have adequate volume and surface area to treat a patient, and allow access for the medical care provider and medical equipment.

7.6.4 Medical Interfaces

For 0g phases of flight, restraints must be provided for the patient, care provider, and equipment.

- Patient restraints must be capable of preventing the motion of arms and legs, allow stabilization of the head, neck, and spine, and provide attachment to the spacecraft.
- Care provider restraints must allow the care provider to remain close to the patient to administer treatment, but should be easily removable or allow movement to access nearby equipment.
- Equipment restraints must be able to safely restrain large items such as medical kits, as well as individual items such as scissors and syringes.

If medical care continues throughout acceleration phases of flight, equipment restraint must be provided near the patient.

Interfaces to potable water, pressurized oxygen, power, and data must be accessible to the medical area, to ensure that medical equipment can use these resources as needed. Access to patient medical history and medical procedures should also be nearby. If a defibrillator is needed, the patient must be electrically isolated from the spacecraft, to protect both the avionics of the spacecraft and other crewmembers from inadvertent shock.

Especially for long-duration missions, because of the limited quantities and variable lifetime of certain medical supplies and medications, a medical inventory system should be used to keep track of this data.

When a care provider treating another crewmember is in communication with the Mission Control Center (MCC), hands-free two-way voice and visual communications should be available between the treatment area and the MCC, in either a real-time or store-and-forward capability.

Medical equipment must be usable by nonphysician crewmembers, in case a physician crewmember is the one that requires medical treatment. To accomplish this, medical equipment should be simple, easy to use and require minimal training.

7.6.4.1 Decision Aids

A decision aid is a special form of procedure that guides the user through a process that includes the selection different courses of action. Decision aids can improve performance in the operation of medical equipment during medical emergencies. This is especially the case when dealing with crewmembers minimally trained in medical practice.

When developing decision aids it is important to base concepts on human factors principles while considering the flow of information and the level of detail that it needs to contain. The following items should be considered in the development of decision aids:

- A clear beginning and ending to the steps and numbering of steps will aid the user to know where he/she is in the procedure and when he/she is finished.
- When considering schematics or pictures for inclusion, make sure they are large enough to be useful while avoiding unnecessary detail that makes the picture difficult to interpret.
- The use of coding or highlighting to stress important details is recommended. Coding can be done with color, and/or font style/formatting (e.g., bold or underlining). However, do not overuse color or violate color conventions (such as using green to highlight a dangerous condition when red would normally be used).

Decision aid development is an iterative process and concepts need to be evaluated through informal and/or formal usability testing. Concepts need to be tested with the success criteria that include time to perform the procedure and errors related to performance (e.g., omitting a critical step, incorrectly performing the action, number of attempts before successful execution).

The respiratory support pack (RSP) cue card used on the ISS is an example of a successful medical decision aid. The Usability Testing and Analysis Facility at JSC evaluated the original layout of the RSP cue card and recommended a new design based on human factors principles. The redesigned cue card organized the content into a linear flow and removed the post-emergency content. The redesigned cue card featured one schematic of the RSP that included color mapping of equipment position (on the schematic) to the name of the item (bordered in matching color in the pack to the procedural step), borders, increased font size of text, and simplification of the flow of information. As a result of these changes, the time to complete the RSP procedure was reduced by approximately 3 minutes. In an emergency situation, 3 minutes increases the probability of saving a life.

7.6.5 Stowage

Treatment consumables, including medications, bandages, and intravenous fluids, must have volume for stowage. Some stowage requires environmental control to ensure viability.

Biological hazards, like blood and other bodily fluids, must be contained and safely disposed of, to minimize contamination of other crewmembers. Sharp items such as syringe needles must be safely disposed of, to prevent inadvertent injury to other crewmembers.

Certain medical equipment, supplies, and medications should be stowed in an easily accessible area, to facilitate quick access in case of a medical emergency. ISS crewmembers have reported on the importance of optimally organized and easily accessible stowage of medical equipment supplies and medications within racks and separate kits.

7.6.6 Research Needs

RESERVED

7.7 STOWAGE

7.7.1 Introduction

This section discusses design considerations for the layout and design of stowage systems inside a spacecraft.

7.7.2 General Considerations

A stowage system can be integrated with a crew station or may be a separate area apart from the normally occupied areas. A stowage area should be seamlessly integrated with an inventory management and disposal plan. The stowage system affects every aspect of crew operations, and insufficient stowage has a severe negative impact on crew operations and efficiency.

Efficient stowage systems are important to maintain inventory in a consolidated location and to avoid unnecessary conflict and collision with supplies and tools that are not in use (Figure 7.7-1). A stowage system contributes to interior order of supplies and hardware and can also be seen as a positive psychological feature. An interior that is messy because of bad or missing stowage may promote stress and irritation for crewmembers (Figure 7.7-2). Lack of awareness of the location of specific items and spending unnecessary time to find these will decrease crew performance, increase task performance time, and pose a danger in emergency situations.



Figure 7.7-1 View of an optimal translation path with minimal rack front stowage from the ISS US Lab.



Figure 7.7-2 Stowage in the ISS Airlock module.

On-orbit stowage conditions can negatively and positively affect habitability, operations, and safety. Definition of requirements for the amount and type of stowage provided for future missions must be based on mission scenario, mission duration, crew size, and specific mission tasks. Stowage “keep out” zones must be established and enforced to protect access to critical equipment and controls such as fire ports. The negative effects of poor stowage include increasing crew time to perform daily operations, violating safety constraints associated with maintaining “keep out” zones around critical equipment and controls (e.g., fire ports, lighting and ventilation sources).

Historically, the ISS hardware stowage requirements have exceeded the defined stowage capabilities, making it possible for safety constraint violations to occur. On-board hardware requirements for crew provisioning, element outfitting, and spare orbital replacement units may have exceeded the on-orbit stowage control limit. Inadequate stowage locations on the ISS has led to aisles being used for stowage, hampering access to panels and crew interfaces and at times stowage was so excessive that it impeded crew translation within modules. To avoid stowage violations and subsequent impacts, it is recommended that all cargo receive a stowage allocation and appropriate processes be in place to manifest stowage and successfully track it upon arrival on-orbit. Onboard and ground monitoring of on-orbit stowage must be consistently performed to validate that the stowage is within control limits.

A stowage system must allow for expansion and changes in stowage performance. Designers must estimate changes such as module additions, rack rotations and hardware maintenance that require the movement and temporary stowage of items, or the inability to return some items to the ground, which requires additional stowage.

According to the Generic Ground rules, Requirements and Constraints, SSP 50261 (SSP, 2005), standard stowage areas must be designed to accommodate standard and nonstandard cargo stowage. Nonstandard stowage capabilities include all areas in which cargo may be safely stowed, although these areas were not specifically designed as stowage locations. Various levels of nonstandard stowage are required for cargo inventory fluctuations and variations in habitat volume with the addition of modules and other spacecraft. Consideration must be made as some locations that seem optimal may be unacceptable due to conflicts with hardware and/or operations. Lessons learned indicate that crewmembers are more likely to skip exercise if setup/takedown time is extensive; therefore, all crew exercise equipment should be easily accessible and operable without the crew having to move stowed cargo prior to use of the

exercise equipment. No integrated combination of momentary, temporary, or permanent protrusions should leave less than a minimum unencumbered emergency translation path of 32 in. × 45 in. (81 cm × 114 cm) without ISS Program approval via waiver or exception. The nominal crew translation path may also be encroached upon by operating volume for crewmembers at worksites, maintenance operations, momentary protrusions, crew-determined operational protrusions, and temporary nonstandard stowage with ISS Program approval.

The following are considerations for the design of a stowage system:

- Volume – The stowage system must accommodate the size and dimensions of all relocatable items.
- Type and Location – Items should be stored in an area as close as possible to where they are used. The following is a list of crew stations and the types of equipment that should be stored adjacent to these stations:
 - Personal Stowage – clothing, personal equipment and belongings, personal hygiene items
 - Workstation – writing equipment, camera equipment, recording equipment, emergency equipment (e.g., extinguisher, first-aid equipment)
 - Hygiene – personal hygiene consumables (tissues, wipes, towels, soap)
 - Galley – food, food preparation directions, utensils, wipes, housekeeping supplies
 - Recreation facility – recreation items (games, reading materials, audio-visual equipment)
 - Meeting areas – writing materials, presentation aids
 - Medical treatment area – medical equipment, pharmaceuticals, dispensary supplies
 - Exercise facility – exercise equipment
 - Body waste management system – wipes, urine collection devices
 - Trash management system – wet and dry trash receptacles, trash bags
- Gravity – In 0g, stowage must be restrained to keep it from floating away. In a gravity environment, stowage should not be located overhead, and stowage locations on the floor should be avoided whenever possible. When stowage systems will be used in multiple gravity environments, designers should consider that these constraints may change from one mission phase to another. Stowage must also be restrained during high-g and vibration flight phases to prevent stowage from coming loose and injuring the crew.
- Nonstandard stowage – The following are considerations to accommodate for non-standard stowage:
 - Nonstandard stowage locations must be based on flight safety and operations requirements, restrictions and limitations.
 - Habitable volumes may be encroached upon by momentary protrusions, operating volume for crewmembers at worksites, and maintenance operations.
 - Crew exercise equipment should be accessible and operable without having to move hardware protrusions or nonstandard stowage.
 - Crew viewing of equipment displays used during exercise should not be blocked during exercise.
 - The area in front of safety critical / emergency equipment requiring crew physical or visual access must remain clear of obstructions (e.g., hardware protrusions and non-standard stowage).
- Habitat Resupply – As habitats (i.e. ISS, lunar habitat) are resupplied, an off-setting amount of stowage is often not returned or removed, resulting in an accumulation of

stowage items. The stowage system should take into account the expected resupply/return of stowage over the habitat lifetime.

- Flexibility – To accommodate changing mission needs, the following should be considered:
 - Standardized container and cover size and design
 - Adjustable shelving and racks
 - Bolted or strapped storage racks and containers
 - Provisions for stowage installation throughout the spacecraft
- Central Storage vs. Distributed Storage – Items should be stored adjacent to their use point. There are cases, however, where this is impractical. A central storage point for some items makes inventory tracking a simpler task. This might include low-use items or items used at many different stations. In many cases a central storage and distributed storage system can be combined. This might occur in the galley, where food for a single meal is stored in a pantry but the entire food supply is stored in a central facility.
- Operability – Stowage containers must be operable without the use of tools, to maximize the use of crew time. For 0g operations, stowage covers must be able to be removed or secured in the open position.
- Accessibility – Stowage systems must be designed to allow for easy access to mission critical and frequently-used items.
- Interference – Stowage systems must not interfere with translation or other operations.
- Labeling – Stowage locations and items must be labeled to allow easy location, replacement, and inventory of items.
- Inventory Management – The stowage system must be compatible with the inventory management system.

7.7.3 Research Needs

RESERVED

7.8 INVENTORY MANAGEMENT

7.8.1 Introduction

This section provides the characteristics of a successful onboard inventory management system design. Such a system can track the quantity, location, and status (e.g., remaining useful life) of inventory items.

The inventory management function is one of the primary elements of onboard information management, and is directly related to the stowage design considerations addressed in section 7.7 Stowage.

7.8.2 General Considerations

One of the most difficult areas of flight data management for human spaceflight has been the creation and maintenance of an on-board inventory management system (IMS). An IMS tracks inventory such as crew equipment, consumables, food, and experiment materials, and where these items are located.

The bar code tracking methodology (see SSP 50007 - Space Station Inventory Management System Bar Code Label Requirements and Specification) for items stowed on the ISS has historically been inconsistent. On occasion, items have been moved and not returned to their designated area and the IMS has not always updated to reflect the new location. This has resulted in the crew spending increased time searching for items they need for daily tasks. Data entry inefficiencies have made it difficult to keep track of items. When designing an IMS, the system should provide a reliable methodology for tracking items, and ensuring that items can be easily placed in their designated locations. Tools for IMS use whether display interfaces or scanning devices should be easy to use and accurately provide information to the crew and ground personnel. Once an optimal design is established, crewmembers should be trained to ensure efficient inventory tracking and to avoid mistakes. Onboard ISS, items have often been transferred without updating IMS. It may not be necessary to update an IMS to reflect temporarily stowed items, but the beginning and end stowage locations should be accounted for when items are stowed or transferred.

When developing an IMS consider the following:

1. Standardization – A standard process for naming hardware and equipment is necessary. The inventory management system nomenclature must be consistent with procedures and labels.
2. Easy to Use – The ability to quickly and easily input data and track items is important for the IMS to be fully used and should be provided. ISS crewmembers have commented that the ISS IMS is too complex.
3. Efficient – The amount of time required of the crew to perform the inventory management function should be minimized.
4. Unique Names – Each item tracked in the IMS must have a unique name so that it can be uniquely tracked. The ISS Operational Nomenclature process accomplished this for the ISS Program. Barcode labels with unique names, part numbers, and serial numbers helped to track hardware and consumables.
5. Facilitates Coordination with Ground Crews – The onboard inventory management data should be capable of being communicated to the ground without onboard crew involvement or capable of being updated by the ground, to take the time burden off the

crew. ISS crews have often noted that it is easier for them to notify the ground when they move something than to take the time to input it into the IMS themselves.

6. Flexibility – The system should be flexible to capture frequently occurring changes in stowage location, status and quantity of items which may occur before launch, on-orbit, and before return.
7. Accuracy – Stowage methodologies should be consistent and common to ensure an accurate IMS. The different US and Russian stowage methodologies on board the ISS deviates from being consistent and common. Therefore, IMS should work accurately and similarly in all segments and modules of a spacecraft.
8. Training – Based on recommendations from ISS crewmembers, ground based training for IMS should include realistic scenarios for the maintenance of the IMS to develop the complex skills needed on-orbit. On-orbit, the IMS should also be properly addressed during crew handover or when new or visiting crewmembers arrive.
9. IMS Task Time – Appropriate amounts of time should be provided to allow crewmembers to interface with the IMS. ISS crewmembers have reported that the operations time for tasks often exceeds the allocated time to IMS related tasks.
10. Item Location and Identification Information – The inventory management database should include the following data elements:
 - Item Number – The number by which each item is identified in the database.
 - Item Name – The standard name used to describe the item and its function (consistent with labels and procedures).
 - Other Name – Nonstandard (slang) names that are often used by the crew. A database should be able to cross-reference the standard and nonstandard names, which are updatable by the crew or ground.
 - Item Functional Designation – An easy-to-learn code that indicates the functional use of the item.
 - Unit Weight – The weight in kilograms (or pounds) of one unit of the item.
 - Unit Volume – The volume in cubic centimeters (or cubic inches) of the envelope space required to stow one unit of the item.
 - Unit Size – The length, height, and width of the envelope necessary to contain the item.
 - Physical Identifying Features – Color, for example.
 - Stowage Location – The stowage location code of the stowed item during each mission phase (e.g., launch, on orbit, return).
 - Quantity Stowed in Each Location – The quantity of stowed items in each stowage location during each mission phase.
 - Total Quantity – The total quantity of each item during each mission phase.
 - From Location – If applicable, the stowage location code from which stowed items are transferred during in-flight phases of the mission.
 - To Location – If applicable, the stowage location code to which stowed items are transferred during in-flight phases of the mission.
 - Quantity Transferred – The quantity of items transferred (or scheduled to be transferred) from one location to another during in-flight phases of the mission.
 - Performance History – A provision for recording crew comments pertinent to the condition and performance of the item during the in-flight phases of the mission.

- Stowage Location Maps – Stowage location illustrations are required to the extent that the difficulty in locating or transferring an item necessitates additional data to support the crew procedures.
- Life Remaining – The shelf life remaining for consumables and the operating life remaining for operating hardware.
- Limit Quantity – The quantity of items such as consumables below which mission operations may be constrained.
- Crew Identification – The name of the crewmember, for personal items.

7.8.3 Inventory Management System Technology

Advances in onboard computers, data storage devices, software, bar coding systems, and communications data links make a computerized IMS less costly and easier to implement. Automated systems prove useful in addressing many inventory issues. Bar code scanners greatly reduce errors and require less time than manual entry systems and are available for use by the ISS crewmember. Radio frequency identification (RFID) tags, which do not require crewmembers to use a bar code scanner, can enable the automated location monitoring of critical equipment, and even locate the equipment in three-dimensional space on board the spacecraft.

Bar codes – The ISS crew has noted that the use of a barcode reader with the IMS to track items has been useful. If bar code labels are used, consider the following:

- Bar coding everything is excessive, and uses extra time when managing consumables. A careful evaluation of which items to be coded should be conducted.
- Ground support should be relied upon for tracking and updating databases, thus taking the burden off of the crew during flight.
- Bar codes can sometimes be hard to scan because of the reflective properties, curvature of surfaces or the size of some of labels. Reflective labels should be avoided.

Reports – The inventory management system must be sortable and searchable such that particular items can be found in the database and/or to prepare various reports. ISS crewmembers have indicated that the onboard IMS needs to provide current, not historical data, and that on-orbit data does not need to mirror IMS data the ground maintains. This avoids overloading the on-orbit IMS. Information must be easily accessible, filtered, and compact. At a minimum, consider the following types of reports:

- Item Status – Display the location(s) for an item that is selected by item number or item name. This report must include the quantity of the item at each location.
- Location Status – Display items (by item number and item name) stowed in a specified stowage location. The quantity of each item in the specified location must be provided.
- Limit Warning Report – An alert message that indicates when quantities of consumables and other items fall below a predetermined limit should be provided.

A lesson learned from the Constellation Program emphasized the importance of defining logistics tracking labels within the scope of a program's labeling standard or having standards provided for the development and processing of those labels.

7.8.4 Research Needs

Determine the feasibility of RFID tag technology for space applications.

Determine the function allocation of inventory management between crew, ground, and automation.

7.9 TRASH MANAGEMENT

7.9.1 Introduction

This section discusses the design of the spacecraft trash management system. Discussion includes the amount and types (biologically active and inactive) of trash as well as considerations for odor and contamination control and containment of hazardous trash. It does not include metabolic and body wastes. Similar to stowage management, trash management is critical for efficient crew operations. The guidelines apply to collection, containment, and stowage in all gravity environments.

7.9.2 General Considerations

Efficient design of a trash management system will minimize the amount of trash generated, provide odor and contamination control, and provide containment for hazardous trash.

Mechanisms and means for stowage and disposal of trash must be in place for all spacecraft, habitats, and missions. A planned trash stowage volume must be defined and allocated for each mission and managed appropriately via an inventory or stowage management system. The trash stowage volume should consider habitability stowage constraints, the logistics of spacecraft undocking, if they are to be part of the disposal plan, as well as the number of crewmembers (i.e., trash generation rates). The ISS crewmembers have indicated that trash needs to be stowed appropriately so it does not affect panel access or impact translation during emergencies (Figure 7.9-1).



Figure 7.9-1 Equipment trash bags and empty food containers stowed in the ISS US Node 1 module.

Each program must provide capabilities for preflight planning, on-orbit operations, and disposal of trash to ensure the safety and health of both flight crew and ground operations personnel. SSP 50481, Rev B, is an example of a trash management plan developed and implemented for the ISS.

Unacceptable and time-consuming trash handling may result in trash build-up, leading to an unhealthy environment for crewmembers, decreased performance, and loss of valuable items.

Considerations for the design of spacecraft trash management system include:

1. Quantity and Type of Trash – The amount and type of the trash will depend on the mission duration, number of crewmembers, and mission activities. Trash items may include food packaging, leftover food, spacecraft cleaning materials, waste and hygiene materials, and payload materials. It must be clear to the crew as to which items are common trash. Some ISS crewmembers have indicated that the operational concept of common trash was not obvious. A list of items that can be put in common trash or common guidelines should be provided to the crew.
2. Monitoring – The trash management plan must be monitored (by crew or ground support personnel) to compare the actual and planned volumes and determine any contingency actions required.
3. Separation – Depending on the system used for trash management, trash may need to be separated into dry and wet trash, to be collected and stowed in separate receptacles. Wet trash, such as wipes and food waste, is subject to off-gassing and leakage, and will require sealed receptacles.
4. Separation of Hazardous Trash – Depending on the type of hazardous waste to be disposed, it may need to be separated to protect crew health as well as the spacecraft. On the ISS, hazardous waste is separated to protect ground personnel.
5. Location of Trash Receptacles – The selection of trash receptacle types and locations should consider crew productivity. Deploying several small trash receptacles throughout a module may initially save crew time but will cost time if the crew has to gather the trash from the receptacles and transport it to a central receptacle.
6. Disposal – To maintain a hygienic environment, trash and associated by-products should not be left on board longer than necessary. Trash should not be stowed in the principal crew living and working areas (see section 6.4 Contamination) and should be as far from them as practical. A limited amount of trash can be re-stowed into volumes from which the hardware or consumables have been removed.
7. Interference – Trash stowage systems (e.g., receptacles) must not interfere with translation or other operations.
8. Contamination – The trash management system must prevent trash materials, including sharp items, chemical and biological waste, from escaping and contaminating the crew and other systems.
9. Cleaning – The trash system should be capable of being cleaned during the mission, as long as crew health and safety are not affected.
10. Odor – The trash management system must control odor.
11. Automation – Trash management must not degrade crew productivity. Every effort should be made to automate trash management and reduce manual manipulation.
12. Equipment and Supplies –
 - Trash management equipment must be operable by the full range of crewmember size and strength.
 - Appropriate restraints must be available in 0g conditions.
 - Trash handling supplies (e.g., wipes, bags, wrapping tape, labels) should be located so that they are easily accessible.
 - Noise-generating equipment (e.g., compactors) should be insulated or isolated from noise-sensitive areas.

7.9.3 Types and Sources of Trash

Trash can be classified as follows:

- Crew Common Trash – trash generated by and common to the entire crew. It consists mainly of wet or dry trash, including used or expired consumables, nonrefurbishable crew provisions, hygiene items, food, and human waste. Crew common trash may be either hazardous or nonhazardous.
- Hardware Trash – any used, defective, or expired hardware. Hardware may be replaced at known rates for items with limited life, or after an unexpected failure.
- Payload Trash – all trash generated from the performance of a payload.
- Launch Restraint Trash – anything used to secure cargo on a launch spacecraft that is not required on orbit for any other planned use.

Sources of trash include the following:

- Flight crew equipment and crew provisions
- Systems and subsystems
- Payload hardware and experiments
- Flight operations material
- Packaging and wrapping material
- Broken or unused items

7.9.4 Trash Classifications

7.9.4.1 Hazardous Waste

Hazardous waste can be classified for disposal in accordance with the nomenclature defined in Table 7.9-1.

Table 7.9-1 Hazardous Waste Classification

Waste Category	Hazardous Waste Definitions
Batteries	All types of batteries (e.g., Ni-Cad, Alkaline).
Biological / Biomedical	Any solid or liquid that may present a threat of infection to humans, including non-liquid tissue, body parts, blood, blood products, body fluids, and laboratory wastes that contain human disease-causing agents. Also to include used absorbent material saturated with blood, blood products, body fluids, excretions, or secretions contaminated with visible blood or blood products that have dried.
Sharps	Payload- and crew-generated needles, syringes, or any intact or broken objects that are capable of puncturing, lacerating, or otherwise penetrating the skin (e.g., glass, scalpels, hard broken plastic, syringes, etc.).
Chemical Hazard	Any waste in solid, liquid, or semi-solid form that is contaminated with a chemical substance that requires special handling during disposal.
Radioactive	Solid, liquid, or gaseous materials that are radioactive or become radioactive and for which there is no further use.

7.9.4.2 Nonhazardous Waste

Nonhazardous waste is any material (wet or dry) that is determined to be waste but does not meet the criteria for any of the hazardous waste classifications. For ground handling, nonhazardous waste is that material that has been determined to be waste that does not meet any definitions and/or criteria of regulated wastes under any federal, state, or local agencies.

7.9.4.3 Toxic Waste

Toxic waste is considered to be dangerous to the crew. The degree of toxicity for any waste is identified by the five toxic hazard levels as defined in Table 6.2-14.

7.9.5 Containment, Handling, and Labeling

The following describes the containment, handling, and labeling requirements for battery, biological/biomedical, sharps, chemical, radioactive, and nonhazardous waste.

All waste containers on returning spacecraft (e.g., Shuttle) require a label identifying the waste type. Labels must be visible on the outermost container to inform the crew or ground personnel of how to properly handling or disposing of the waste. Waste containers disposed of on expendable spacecraft do not require labels. Before transferring waste containers to a return spacecraft, verification of proper labeling needs to be performed. It is important for purposes of safe ground handling that the waste container label is marked accurately and completely. When multiple types of hazardous waste are accumulated in a single hazardous waste container, the outermost container label must indicate the highest level of toxicity contained (Table 6.2-14).

SSP 50094, NASA/RSA Joint Specifications Standards Document for the ISS Russian Segment, provides an example of the labeling standard from the ISS Program.

For hazardous waste, the waste label on the outermost containment barrier must identify all battery (BA) hazards, biological/biomedical (BB) hazards, sharps (SH) hazards, chemical (CH) hazards, and/or radioactive (RA) hazards. In addition, these hazards have the following handling requirements:

- Battery Hazards – Batteries must be inspected for damage before disposal. If damaged, both terminals of the battery must be taped.
- Biological/Biomedical Hazards – Biological and biomedical hazards must be sealed in a bag and then contained in a secondary container.
- Sharps Hazards – All sharps hazards must be placed in an approved sharps container for disposal. Sharps containers must be puncture resistant, leak proof, and sealable.
- Chemical Hazards – Individual chemical types (based on chemical properties and not on hazard levels) must be stowed for disposal in separate sealable waste containers. Chemicals stored in proximity to each other must be compatible. Otherwise, a second level of containment may be required.
- Radioactive Hazards – Radioactive waste must be packaged, labeled, and handled in accordance with requirements established by the Kennedy Space Center (KSC) Radiation Protection Officer or the JSC Radiation Health Office and approved by the appropriate safety review panel. An assessment of these hazards should be made on a case-by-case basis.
 - The NASA Chief Radiation Safety Officer evaluates any waste that is identified as a radiation emitter before it can be disposed of on an expendable spacecraft.

For U.S. hardware or payloads, JSC Form 44, Ionizing Radiation Source Data Sheet - Spaceflight Hardware and Applications, is required to be submitted to define the radioactive material and procedures (labeling, isolation, removal, etc.). This form is part of the Safety Data Pack.

- According to the Nuclear Regulatory Commission (NRC), the container for urine may be disposed of if the effluent concentration of the radioactive waste does not exceed the concentration specified by the NRC. The limiting concentration varies from 10^{-6} to 10^{-3} curie (Ci)/milliliter (mL), depending on the type of radioactive material, where 1 Ci is equal to 3.7×10^{10} disintegrations per second, or 3.7 Bq (becquerel, the SI unit). The waste can be burned once the effluent concentration is below the limit.
- Nonhazardous Waste – No special on-orbit handling requirements for nonhazardous waste exist. The waste label should identify wet or dry status.

7.9.5.1 Trash Containers

Containment is the packaging process required by a safety review panel to prevent the crew from being exposed to a hazard. A trash container may be certified to hold dry or wet nonhazardous waste, hazardous waste, urine, solid waste, or a combination of these types. A container does not protect the crew from any hazards. It merely provides a receptacle for the storage and disposal of trash.

Trash generation volumes and types must be assessed for each mission, to determine the appropriate types and sizes of standard trash containers that must be provided to accommodate trash. Trash containers should ensure that odor is contained as much as possible.

Trash that is not accommodated by standard trash containers because of its size, shape, or some other property is contained in special handling hardware. This hardware is provided by the system or payload organization responsible for the system or payload that generates the trash. All nonstandard trash containers should be certified for disposal on any available spacecraft.

7.9.5.2 Trash Disposal Planning

All spacecraft and habitats must have a plan for trash disposal. Accommodations must be made for trash returning to Earth, to ensure safe stowage of trash on board the spacecraft and disposal upon return. For long-duration missions in LEO with visiting spacecraft, plans for return to Earth must be developed including prioritization plans and stowage accommodations. This can be accomplished by using return spacecraft (Space Shuttle from ISS) or expendable spacecraft (Progress spacecraft from ISS). For long-duration flights, sufficient stowage space must be made available, or if possible, a means to dispose of the trash in-flight should be provided. Disposal constraints must be kept in mind for the various types of trash (e.g., hazardous, radioactive).

To minimize the quantity of trash remaining on board some trash may be removed from the spacecraft. For crew health considerations, the removal of trash should proceed in the following order:

1. Hazardous waste
2. Urine
3. Solid human waste
4. Wet nonhazardous waste
5. Dry nonhazardous waste (includes broken or unused items ready for disposal)

As missions move beyond LEO, returning trash to the Earth becomes less likely due to the propulsive energy required to send it there. Disposal on a planetary surface or in deep space (i.e., en route to Mars) may become the preferred method. Furthermore, on such missions certain types of trash may be considered a resource for future use. While discarded equipment may certainly be considered trash, it might contain the spare parts needed to repair some other item. Storing all such trash inside a habitat is not possible, but having a “bone yard” on the lunar surface might be feasible. Concepts and guidelines for such practices, including inventory control and safe storage, do not yet exist, but are foreseen as one way of reducing the logistics train of spare parts that may be necessary for a robust outpost.

7.9.6 Research Needs

RESERVED

7.10 SLEEP

7.10.1 Introduction

This section provides guidelines for the design and layout of sleeping areas, including differences that apply to various gravity environments and mission durations.

7.10.2 General Sleep Considerations

Sleep is important for maintaining crew comfort, concentration, and awareness during waking hours. Poor-quality sleep or lack of sleep can be tolerated for short periods, but can have negative effects on mood and performance over extended durations.

Factors that affect sleep include:

- Environmental conditions (temperature, light, noise, ventilation)
- Illness and medications
- Stress
- Workload
- Sleeping pattern
- Comfort
- Timing of meals
- Sleep system design
- Sleep shifting to accommodate crew and mission schedules

Less than 8 hours of sleep has been found to result in cognitive performance decrements (Van Dongen, et al., 2003). The ISS crewmembers have indicated that it is not always possible to sleep a full 8 hours during specific mission segments or due to individual issues.

Mission days may need to be shifted from the normal Earth day for launch to take place during predetermined launch windows, which may disrupt the crew's normal circadian rhythm. For nominal operations, crewmembers need 1 day of circadian adjustment for every 1 hour of sleep shifted eastward (earlier) or 2 hours shifted westward (later). Experience on the ISS has shown that shifting earlier resulted in increased crew fatigue, and that the crews' preference was to shift later gradually. An early shift is more likely to lead to sleep deprivation, since the next workday starts early and crews might not have been able to get to sleep at a normal time the night before.

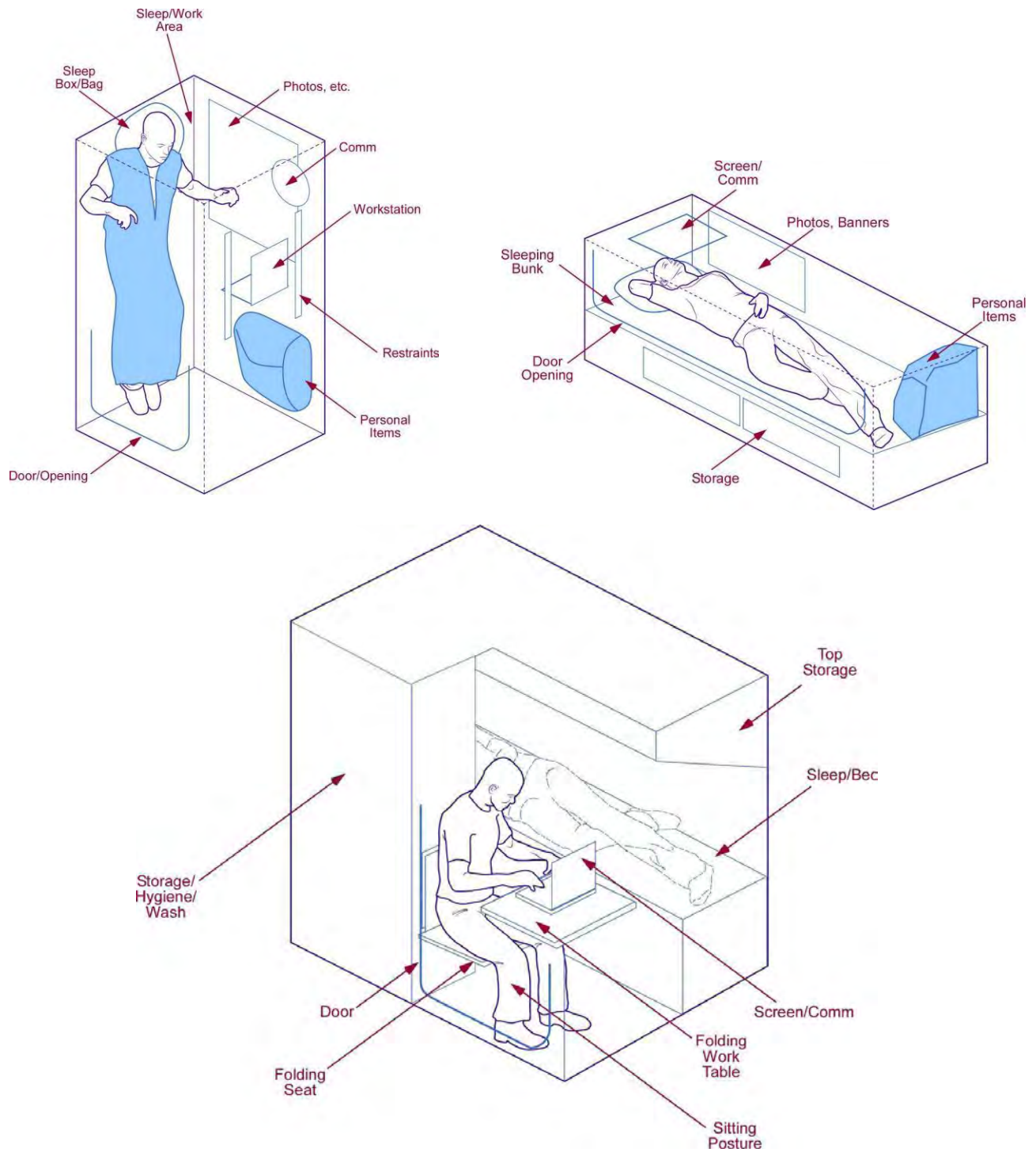
7.10.3 Sleep Area Design Considerations

The spacecraft must support sleep by providing adequate volume, sleep surface area, and environmental conditions (e.g., lighting, noise, ventilation, humidity, and temperature; see HIDH Chapter 6). In 0g, a flat surface area (without protrusions) may be important for crewmembers to restrain themselves for sleep. For partial-g, sleeping surface area must be horizontal. In the lunar module, the Apollo 14 crew slept very little because of difficulty finding a place to rest their heads, discomfort of the pressure suit, and the 7-degree tilt of the module (Strughold and Hale, 1975). On the ISS, crewmembers sleep in sleeping bags that are secured, in a vertical position, to a wall within their crew quarters.

Sleep systems must have sufficient surface area and volume for the largest crewmember and the expected body postures and ranges of motion (see Figure 7.10-1) for the following:

- Sleeping
- Stowage of operational and personal equipment
- Donning and doffing clothing

- Recreation and relaxation (including reading, and using a computer and other personal items)



A: Crew quarters in 0g. Minimal room for sleeping, working, and rest, done in the same space. Medium-duration mission. B: Partial-gravity crew quarters. Minimal room for sleeping and resting for medium duration. C: Partial-gravity crew quarters. Large volume for long-duration missions. Working, sitting, standing, sleeping combined with hygiene, stowage, and waste management.

Figure 7.10-1 Examples of Sleep Areas.

Sleep systems may consist of dedicated, separate volumes used for sleep, crew quarters that serve additional privacy functions or simple padding and restraint that may be used for short-duration missions. Furthermore, the ISS crewmembers have consistently emphasized the importance of the provision of dedicated sleeping quarters for each crewmember living onboard. Sleep systems must allow crewmembers to control lighting, ventilation, and temperature. Adequate ventilation washout of the sleeping area is required to preclude unacceptable carbon dioxide levels in area. Ventilation should preclude odors in head positions of sleep area. Generally, ventilation flow should be from head area, down to foot area.

The selected sleep system type and volume depend on mission duration, mission scenario, and available volume. Implementation can be done at different levels from sleep areas, beds, individual crew quarters, shared crew quarters, and larger private crew quarters containing waste and hygiene management. In general, short-duration missions, such as LEO or lunar transit, may require only temporary sleep areas. Missions greater than 30 days in duration must have dedicated crew quarters that provide privacy.

Table 7.10-1 presents some general considerations that are recommended for designers of crew quarters to follow.

Table 7.10-1 Sleep System Considerations for Different Mission Durations

Mission duration	Mission example	Types of crew quarters	Comments
Short (~ 2 weeks)	LEO, lunar transit	Sleeping bag, open sleep area	
Medium (< 6 months)	ISS, <i>Mir</i>	Shared quarters, private quarters	Crew quarters do not have waste management or hygiene facility.
Long (> 6 months)	Lunar/Mars outpost, flight to Mars	Private quarters	Crew quarters might have waste management or hygiene facility.

Nondedicated crew areas used for sleep during short-duration missions should be easy and fast to set up and take down (e.g., sleeping bag). Sleep preparation operations that require excessive time can result in reduced sleeping time resulting in decreased crew performance. It should be easy to ingress and egress all sleep areas.

Crew quarters are considered to be psychologically important, especially during long-duration missions, where privacy issues can help avoid group tensions, heighten crew morale, and decrease stress. The crew quarters functions as a replacement for “home.” Crew-quarter design should incorporate features that contribute to feelings of security, comfort, privacy, personality, relaxation, and other aspects of behavioral health.

The design and layout of the sleep system depends on the functions that are to be performed. Table 7.10-2 shows the functions that might occur in or around a sleep system and the design considerations to accommodate these functions.

Table 7.10-2 Sleep System Functions and Design Considerations

Function	Design Considerations
Wake up	Alarm or annunciator
	Adequate lighting*
Don and doff clothing	Adequate volume
	Privacy (i.e., door)
	Restraints for 0g
	Clothing and personal items storage
Groom	Adequate lighting
	Mirrors
	Stowage for grooming supplies
	Proximity to personal hygiene facility
Relax	Communications with friends or family
	Entertainment material: books, audio and video entertainment, games, etc.
	Adjustable lighting
	Window
	Ventilation and temperature control
	Restraints for 0g
	Radiation shielding
	Aesthetically pleasing environment
Prepare for sleep	Clothing storage
	Proximity to personal hygiene and body waste management facility
	Privacy
Sleep	Minimal noise
	Privacy
	Adjustable lighting
	Bedding
	Restraints
	Ventilation and temperature control
	Radiation shielding
	Minimal vibration
Respond to emergency	Alarm
	Two-way communications with other crewmembers or ground control
	Emergency lighting
	Properly configured door and path
Work	Privacy
	Workstation

7.10.4 Research Needs

RESERVED

7.11 CLOTHING

7.11.1 Introduction

Crew clothing is needed in order to ensure crew comfort. The type and amount of crew clothing depend on several factors, including mission tasks and duration, which are discussed below.

7.11.2 General Considerations

When considering the type and amount of clothing to provide for a crew, the following mission parameters need to be assessed:

- Mission duration
- Weight and volume limits
- Number of crewmembers
- Atmospheric gases and pressure
- Atmospheric and surface temperature
- Maximum dew point
- Ventilation
- Equipment operation, maintenance, and repair tasks
- Potential for exposure to environmental hazards such as toxic materials or electrical shock
- Crew metabolic rates (work, exercise, sleep)
- Crew population anthropometrics

In addition, the design and provisioning of all IVA clothing need to be consistent with the following guidelines:

- Exclusive Use – Clothing must be provided for each crewmember's exclusive use.
- Comfort – Clothing must be comfortable in fit and composition, and compatible with the environment (e.g., temperature and humidity) in which it will be worn
- Unassisted Donning and Doffing – Clothing must be designed so that the crewmember can don or doff the clothing without assistance from other crewmembers in normal as well as in emergency situations.
- Cleanliness and Durability – Clothing must be durable, washable, or replaceable as necessary to maintain crew health and comfort.
- Body Effects – The effects of the generation of body hair, the flaking of skin, loss of hair, and perspiration should be considered in the design of the garments and in the selection of clothing materials.
- Materials and Fabrics – Garment materials must be odor-free and not off-gas toxic chemicals into the confined spacecraft environment, and be approved for spaceflight.. Additionally, materials should be selected for chemical stability, moisture absorption, water compatibility, strength, abrasion resistance, flexural endurance, wrinkle/shape recovery, ease of cleaning, electrostatic properties, crease resistance, and freedom from lint.
- Sizing – The range of sizes available must be sufficient to provide a comfortable fit and allow for unrestricted movement for each member of the crewmember population without the need for custom-fitted garments. Zero-g effects on the following body measurements should be considered (see section 4.3 Anthropometry):
 - Increase in height due to spine lengthening
 - Increase in chest and waist circumference and decrease in limb volume due to fluid shifting
 - Decrease in body mass due to loss of fluids and metabolic changes

- Adoption of a neutral body posture
- If clothing is to be worn during combinations of environmental conditions (preflight, 0g, partial gravity, postflight), it should be flexible in design to accommodate the above changes as needed.
- Personal Preferences – Garment options should be provided that allow crewmembers to select various styles, combinations of garments, different colors and different pocket styles and cuffs.
 - Stowage – Clothing should be designed to facilitate stowage solutions, allowing crewmembers to temporarily stow items while working and translating through spacecraft volumes. Velcro or other attachment methods may be of assistance to temporarily restrain items to clothing for use.
 - Outerwear Hazards – The outer surface of all outerwear garments must be free of loops, straps, and other obstructions that can snag on equipment.
 - Inner Surface Hazards – The inner surface of garments must be free of items that can impede free movement, scratch, or chafe the wearer.

7.11.3 Disposable vs. Reusable Clothing

Crew clothing may be either disposable or reusable. Reusable clothing is microbe-resistant clothing that is capable of being washed during the mission. The choice of disposable vs. reusable clothing for a particular mission should be made through trade studies evaluating factors such as cost, mission duration, spacecraft resource constraints (weight, volume, power), and the availability and reliability of laundry system technologies.

7.11.4 Clothing Quantities and Frequency of Change

Clothing must be provided in quantities sufficient to meet crew needs. Articles of clothing will need to be changed at different intervals during a mission, depending on crewmember personal preferences and hygienic needs. Since the spacecraft environment is very controlled, a complete change of clothing is not a daily requirement. Also, to provide comfort over a wide range of conditions such as spacecraft temperatures, daily clothing options should allow selection from a variety of garments such as shorts, trousers, short- or long-sleeve shirts, and a jacket. These items of clothing should coordinate well and have a professional appearance. The actual quantities of clothing will be the result of a combination of crew personal preferences and mission constraints.

Frequency of change is dependent on mission specifics; i.e., duration, stowage and laundry capabilities, etc. Crewmembers on shorter-duration missions may not be held to the same clothing constraints as those on long-duration missions. Long-duration missions may require clothing to be worn for extended periods of time and be constructed of antimicrobial fabrics that are extremely lightweight, whereas a shorter mission may accommodate more frequent clothing changes and a greater variety of fabric options.

Examples of ISS Crew Provisioning items, including clothing, can be found in the Joint Crew Provisioning Catalog, SSP 50477 (SSP, 2000). A full description of the STS crew clothing is found in JSC-12770 (Space Shuttle Program, 1984).

7.11.5 Clothing Packaging and Storage

All intravehicular activity garments (outerwear, innerwear, footwear, gloves, and headwear) need to be designed, packaged, and stored to address the following considerations:

- Identification and Removal from Stowage

- Garment package and stowage must be designed to make it easy to identify the type, size, and owner of the garment, if applicable.
 - Garment package and stowage should be designed for easy removal of garments.
- Preserve Garment Appearance – Stowage and packaging of clean garments must be designed to preserve the garment’s appearance.
- Soiled Garment Storage – Stowage for soiled garments must be provided.
- Stowage – Garment stowage should be designed to provide easy storage of garments.
- Clothing should permit labeling to identify the owner.

7.11.6 Research Needs

RESERVED

7.12 HOUSEKEEPING

7.12.1 Introduction

Housekeeping is a crucial part of habitability. It plays a primary role in maintaining the cleanliness of the spacecraft and thus the crew's health and safety, which will consequently boost their morale, comfort, and productivity.

7.12.2 General Considerations

The focus of this section is on the removal of unwanted materials such as dust, lint, liquids, and other debris and contaminants from spacecraft. This may be from the air or air filtration devices, or from accessible surfaces located in the crew's living quarters, work facilities, and other habitable areas in the space environment, including spacecraft and the surfaces of other planets and planetary satellites, such as Mars and the Moon. Consideration should be given to various contaminants of the space environment and how they can be removed safely, effectively, and efficiently from the crew's habitable environment through routine housekeeping activities. These activities should not require communication with the ground, use of nonhousekeeping tools, or complex procedures. Typical housekeeping tasks for a crew might involve periodic cleaning of air filters and wiping down frequently used surfaces such as handrails, galley areas, walls, toilets, and exercise equipment with microbial or disinfectant wipes to prevent dust or bacterial or mold growth from accumulating. The frequency and type of housekeeping activities that will be performed depend on many unique factors such as these:

- Mission duration
- Gravity environment
- Spacecraft configuration and size
- Environmental control system efficiency
- Composition of accessible surface materials
- Stowage allotments
- Waste disposal methods available
- Crew operations
- Number of crewmembers

Clearly, each of the above factors cannot be specifically addressed with regard to housekeeping; instead they will be generically addressed through identification of potential contamination sources, good design features that will mitigate the need for excessive housekeeping, and past operational housekeeping experiences in space. Other aspects of housekeeping, such as organization and stowage of items and equipment, are covered in other related sections of this handbook.

7.12.3 Contamination Sources

Housekeeping for spacecraft and facilities can be mitigated by focusing on the sources of dust, lint, liquids, and other debris and contaminants. The system can then be designed and operated to control these sources and reduce the time devoted to housekeeping. The following are some of the principal sources of microbes, chemicals, and debris that can cause housekeeping problems:

- Crewmembers – Fingernail clippings, hair, dead skin, fingerprints, body fluids
- Clothing – Loose lint, threads, buttons, fasteners
- Dining and Food Preparation Areas – Crumbs, spills
- Maintenance – Loose parts, filings, leaks from disconnected valves, leaking fluids

- Payloads – Animals, plants, chemicals, effluents
- Fluids – Water, drinks, cleaning fluids used for housekeeping.
- Body Waste and Hygiene Areas – Soaps, water, urine, feces, vomitus, menses
- Trash – Wet, dry, and hazardous waste
- Damp Surfaces – Condensation, spills, or poor drainage can promote the growth of mold and mildew (This is especially a problem if the surfaces are poorly ventilated or poorly lit.)
- Planetary Soil and Dust – Planetary missions will include the management of lunar dust (regolith) and martian dust within the habitable area and the operating systems.
- Velcro – Velcro can shed its own lint as well as pick up other materials, such as food and liquids, creating a breeding ground for fungal and bacterial growth.

7.12.4 Housekeeping Tools

Cleaning Materials – Cleaning materials must be effective, safe for use, and compatible with spacecraft water reclamation, air revitalization, and waste management systems. All cleaning supplies, materials, and fluids used must be compatible with surfaces to which they may be applied, and need to adhere to program requirements for off-gassing and toxicity.

Wipes – There are several types of wipes: solution-saturated wipes for general body cleansing or general housekeeping, disinfectant wipes/towelettes saturated with a cationic detergent, absorbent mitts, and dry paper wipes for general housekeeping. Crews prefer a single-step biocide that does not have to be washed off. A handle, holder, or gloves are preferred when using biocide wipes as the biocides currently available stain the hands. Crews have requested an aromatic disinfectant. Urine spills were cleaned up satisfactorily by biocide wipes, but removal of the urine odor is especially important. Absorbent mitts are used for chemical spills, such as when the Russian waste collection system leaked. For highly toxic or concentrated chemical spills, silver-shield gloves and bags should be used. These gloves and bags possess breakthrough values that allow for long-term storage of toxic substances.

Vacuum Cleaners – Vacuum cleaning systems should have the following features:

- user-friendly for the crew
- portable
- easy to maintain and repair
- has disposable bags that are easy to replace
- has attachments appropriate for cleaning filters efficiently
- capable of vacuuming dry and wet particulates
- small, to minimize stowage needs
- quiet, to minimize noise concerns

Vacuum cleaners have been used effectively on Skylab, *Mir*, and the ISS to remove dust, lint, liquids, and debris from surfaces and air filters. On Skylab, the vacuum was also used for removing water from the shower walls. The ISS wet/dry vacuum cleaner (with bags) contains a HEPA filter to capture small particulates. It also can contain both wet (up to 24 ounces) and dry nontoxic debris (up to 100 cubic inches) and has a nominal operating life of 10,000 hours. However, the ISS vacuum cleaner has not been as powerful as has been desired by the crew. The Shuttle Environmental Control and Life Support System did not initially have adequate air flow and filtration to control particulates. The addition of the Orbiter Cabin Air Cleaner significantly improved air quality.

Planetary Surface Dust Control Procedures – A phased approach to dust and debris containment, including suit and spacecraft design as well as operations, could address “housekeeping” procedures for decontamination of crewmembers when they re-enter their lunar or martian habitat after being on the planetary surface, with a final housekeeping procedure performed before they enter the crew’s habitable environment.

7.12.5 Housekeeping Minimization Through System Design

Housekeeping should be minimized initially through proper attention to system design features. Consider the following spacecraft/habitat design factors to minimize the hazards from contamination and the time and resources required for housekeeping:

- Surface Materials – Materials used for exposed interior surfaces must be selected to minimize particulate and microbial contamination and be easy to clean (i.e., smooth, solid, nonporous materials such as plastic or metal, biocide-impregnated fabric). Poorly selected surface material can be seen in Figure 7.12-1.



Figure 7.12-1 Microbial growth on an ISS panel during ISS Expedition 9.

- Grids and Uneven Surfaces – Grids and uneven surfaces should not be used or they should be easy to remove for easy cleaning (e.g., grid floors).
- Cracks and Crevices – All interior structural surfaces and equipment should be free of narrow openings and crevices that can collect liquid or particulate matter or that require special cleaning tools.
- Closures – Closures should be provided for any area that cannot be easily cleaned.
- Fluid and Debris Collection or Containment – A means should be provided for collecting and/or containing any loose fluids or debris that may result from operational use, component replacement, maintenance, service, or repair.

- Condensation – Condensation must be prevented from persisting on surfaces, in order to reduce bacterial growth.
- Built-in Spill Control – Any subsystem or hardware that is routinely used with containers of liquids or particulate matter should have built-in equipment or methods for the following:
 - to capture liquids or particulate matter
 - to prevent liquids from vaporizing into the atmosphere
 - to prevent material from overflowing during use
 - to allow for decontamination of spills
- Transfer Containers – Transfer containers, if they are required, must prevent contamination during transfer and disposal.
- Filters – The filters should be easily accessed for them to be cleaned via mechanical means (e.g., vacuum cleaner) or manually (e.g., gray tape), and for retrieval of small items that have been lost. Air revitalization systems and filters for air-cooled equipment collect various types of debris including tape, lint, hair, small parts, tissues, nail clippings, and food crumbs.
- Trash Management – See section 7.9 Trash Management
- Body Waste and Hygiene Areas – Body waste and hygiene areas should be designed with maintenance and cleaning in mind. Efficient design of these areas can greatly reduce the amount of cleaning fluid and body fluids released into the environment and allow the crew to perform hygiene functions in a manner that will reduce the need for additional housekeeping.
- Dining and Food Preparation Areas – These areas must be designed to prevent growth of mold and bacteria while promoting easy maintenance and cleaning.

7.12.6 Summary of Past and Present On-Orbit Housekeeping Operations

The information provided below concerning the ISS, *Mir*, Skylab, and Space Shuttle housekeeping subsystems is derived from the Space and Life Sciences Flight Crew Support Division's document, Comparison of *Mir*, Shuttle and ISS Habitability (Campbell, 1995).

- ISS U.S. Segment – The ISS U.S. Segment housekeeping subsystem supports routine cleaning with the use of a portable wet/dry vacuum cleaner, six kinds of wipes (which are consumable and resupplied with each mission), detergent, wipes cartridges, and dispensers for the cartridges and detergent. All crewmembers perform housekeeping tasks as needed or during the 4 hours a week that housekeeping is scheduled. Examples of planned ISS housekeeping tasks per the Generic Ground rules, Requirements and Constraints Part 2, SSP 50261-01 (SSP, 2005), Housekeeping Tasks, are shown in Table 7.11-1.

Table 7.11-1 ISS Housekeeping Tasks

Location	Housekeeping Task	Method and/or Equipment Used	Service Interval	Crew Time (min)
All	Wipe down frequently-touched surfaces (e.g., handrails, Utility Outlet Panels, General Lighting Assemblies, Audio Terminal Units)	Utensil rinse wipes or microbial growth wipes	Weekly	As required
All	Inspect surfaces for visible microbial growth; notify Mission Control	Fungistat or disinfectant wipe, rubber glove wipes	Weekly	As required
All	Visual inspection, including known dust and condensate collection areas	Utensil rinse wipes or microbial growth wipes	Weekly; clean as needed	As required
All	Clean surfaces where trash is stowed	Microbial growth wipes or disinfectant wipe	Weekly or each time trash is transferred	5
Lab, NODE1, A/L	Disinfect ventilation air grilles	Disinfectant wipes, rubber gloves	Weekly	10
NODE1, Lab, A/L	Disinfect return air grilles	Disinfectant wipes, rubber gloves	Weekly	10
NODE1, Lab, A/L	Disinfect supply diffusers	Disinfectant wipes, rubber gloves	Weekly	10
NODE1, Lab, A/L	Clean air sample probes	Vacuum cleaner or gray tape	Weekly	5
Lab	Clean and disinfect Trace Contaminant Control System inlet	Disinfectant wipes, rubber gloves	Weekly	5
NODE1	Clean Bacteria Filters	Ratchet, 1/4-in drive; 5/32-in hex head; vacuum cleaner or gray tape	90 days	15
Lab, A/L	Clean Bacteria Filters	Ratchet, 6-in extension; 1/4-in drive; 5/16-in hex head; U.S. vacuum cleaner or gray tape	90 days	20

Location	Housekeeping Task	Method and/or Equipment Used	Service Interval	Crew Time (min)
SM, Lab	Clean surfaces of walls and panels frequently touched (lights, power switches, vent handles, etc.) in sleeping quarters	Microbial growth wipes	Weekly	20
SM	Clean cycle ergometer and treadmill handrails and surfaces	Microbial growth wipes	Every 14 days	20
SM	Clean surfaces where food is prepared and consumed	Wet wipes	Daily	5
SM	Clean table, seats, and refrigerator	Microbial growth wipes	Every 14 days	5
SM	Clean walls of toilet cabin area, all panels in toilet cabin, surfaces of toilet, and surfaces of urine funnel	Microbial growth wipes	Every 14 days	15
SM, FGB, DC1	Wipe down hatches and handrails	Microbial growth wipes	Every 14 days	As required
SM, FGB, DC1	Vacuum filters and inlets	Russian vacuum cleaner	Weekly	40
As required	Clean surfaces where trash is collected	Microbial growth wipes or utensil rinse wipes	Weekly	5

Note: A/L, airlock; DC1, Docking Compartment 1; FGB, Functional Cargo Block; SM, Service Module

- *Mir* – *Mir* housekeeping involved 1 day of general housekeeping, usually scheduled on Saturday. The equipment and consumables used to support cleaning and elimination of contamination on surfaces aboard *Mir* included a vacuum cleaner, a surfactant/disinfectant, and wipes. A typical weekly task would be for the entire crew to wipe down the entire core module with wipes and antiseptic solution. Not all *Mir* surfaces and locations could be reached for cleaning with wipes and cleansing agent. *Mir* did have a large amount of microbial growth on board, in part because of the design of the environmental system. The thermal control system also contributed to microbial growth because it had cold spots that would condense moisture in stagnant areas.
- Space Shuttle – A main focus of the Space Shuttle’s housekeeping subsystem involves cleanup of contamination in the crew cabin. This subsystem provides a vacuum cleaner, wet and dry wipes, biocide cleanser (a liquid detergent formulation of soap, Lysol, ethanol, and water), dispensers for wipes and cleanser, and disposable gloves.
 - On several early Space Shuttle flights, beginning with STS-5, debris issues were identified. By STS-7, “filter cleaning” became a scheduled maintenance activity. The task was time-consuming (2 hours) because it involved removing several panels of

the flight deck to clean several different air filters and screens. This routine task was conducted at least 3 times during the 14-day flight.

- Skylab – Housekeeping aboard Skylab mainly entailed the cleaning and removal of contamination in the spacecraft interior. It included the use of a vacuum cleaner, 4 types of wipes, a biocide, and disposable plastic gloves. Typical housekeeping tasks on Skylab were the frequent cleanup of food and beverage spills. Wet rags were used for food messes and spills because they were considered to be more absorbent. The long durations (28 to 84 days) of the missions made it especially important to attend to the air filtration aspects of housekeeping, to avoid crew illness through air contamination.

7.12.7 Research Needs

Need to determine how to limit the entry of lunar or planetary dust into the habitable volume, and how to clean it in case it does enter.

7.13 RECREATION

7.13.1 Introduction

Recreation is an important consideration for maintaining high morale during space missions, especially for long durations. This section provides guidelines for recreational activities.

7.13.2 General Considerations

Recreation activities must be supported in a spacecraft. Recreation activities must not interfere with critical translation paths and in-use workstations. The type and size of recreation facilities will depend on the number of crewmembers, mission duration, and overall recreation preferences of the crew. During short-duration missions, there may be little time for recreation besides looking out the window or enjoying the reduced-gravity environment. However, during long-duration missions, additional recreation should be considered. The ISS crewmembers have emphasized the importance of providing adequate time and provisions for recreation, both as a crew and individually. When possible, scheduled crew tasks should not interfere with personal time designated for rest and recreation activities.

Recreation materials such as books, CDs, DVDs, and musical instruments are often flown on mission to provide a sense of normality and a break from mission tasks. As mission duration increases, so does the importance of providing leisure activities for off-duty hours. Activities and materials will also depend on preferences of the individual crewmembers, as well as crew interaction. Joint recreation activities, such as games, may become more important on longer-duration missions.

Consider the following when designing for recreation in a spacecraft:

- Storage – Storage should be available for games, books, audio-visual materials, and other recreational items.
- Size – There should be a recreation volume large enough for all crewmembers to take part in an activity at the same time.
- Location – Recreation activities must be located in an area that will not interfere with critical spacecraft functions, such as piloting.
- Selection of Recreation – The following favorite leisure activities of crewmembers should be considered:
 - Communicating with friends and relatives on Earth
 - Earth and space observation via onboard windows
 - Looking out the window at Earth and space
 - Listening to music
 - Watching movies
 - Writing
 - 0g (and partial-g) acrobatics

7.13.3 Research Needs

RESERVED

7.14 REFERENCES

- Campbell, P. & Stecyk, P. (1995). Comparison of *Mir*, Shuttle and International Space Station Habitability, In *Human Factors and Ergonomics Society Annual Meeting Proceedings*, pp. 953-953(1), Human Factors and Ergonomics Society.
- Constellation Program (CxP). (2005). Nutrition Requirements, Standards and Operating Bands for Exploration Missions. JSC 63555, Houston, TX. NASA JSC.
- Cooper M., Douglas G., Perchonok, M. 2011. Developing the NASA food system for long-duration missions. *Journal of Food Science*. 76(2):R40-48.
- Dietlein, L. F. (1975). Summary and Conclusions. In J. F. Parker & W. L. Jones (Eds.), *Biomedical Results from Apollo* (NASA SP-368, pp. 573–579). Washington, DC: U.S. Government Printing Office.
- JSC 28913. (2005). Medical Requirements Integration Documents (MRID). Space Medicine and Health Care Systems Office. Houston, TX. NASA JSC.
- Meilgaard, M., Civille, G.V., Carr, B.T. *Sensory Evaluation Techniques*, 3rd ed. Boca Raton, FL: CRC Press, 1999. Pp. 165-166, 243
- Microbiology Operations Plan for Spaceflight, JSC 16888. Houston, TX. NASA JSC.
- NASA-STD-3001. (2007). Space Flight Human System Standard, Volume 1. Houston, TX. NASA JSC.
- OpsHab (Operational Habitability). 2001. Debrief Summary for ISS Expedition. Houston, TX. NASA JSC.
- Space Shuttle Program. (1984). Shuttle Flight Operations Manual. JSC 12770. Houston, TX. NASA JSC.
- SSP (Space Station Program). (2005). Generic On-Orbit Stowage Capabilities and Requirements: Pressurized Volume. SSP 50261. Houston, TX. NASA JSC.
- SSP (2007). Management Plan for Waste Collection and Disposal. SSP 50481. Houston, TX. NASA JSC. (incomplete reference)
- SSP (Space Station Program), (2000). Joint Crew Provisioning Catalog, SSP 50477. Houston, TX. NASA JSC.
- Rucker, M. (2004). Exercise Countermeasures: A Baseline ISS Hardware Strategic Plan. NASA, JSC 62686. Houston, TX. NASA JSC.
- Strughold, H. & Hale, H. B., (1975). Biological and Physiological Rhythms. In *Foundations of Space Biology and Medicine*. Volume 2. Book 2. Nauka, Moscow.
- Thornton, W. E. & Rummel, J. A. (1977). Muscular Deconditioning and Its Prevention in Spaceflight. In R. S. Johnston & L. F. Dietlein (Eds.), *Biomedical Results from Skylab* (NASA SP-377, pp. 191–197. Washington DC: U.S. Government Printing Office.
- Van Dongen, H. P., Maislin, G., Mullington, J. M., & Dinges, D. F. (2003). The cumulative cost of additional wakefulness: dose-response effects on neurobehavioral functions and sleep physiology from chronic sleep restriction and total sleep deprivation. *Sleep* 26, 117-126.

TABLE of CONTENTS

8	ARCHITECTURE.....	659
8.1	INTRODUCTION.....	659
8.2	OVERALL ARCHITECTURE DESIGN	659
8.2.1	Introduction	659
8.2.2	Architectural Design Drivers	659
8.2.3	Gravity Environments	660
8.2.4	Internal Size and Shape of Spacecraft.....	661
8.2.4.1	General Factors That Affect Internal Size and Shape	661
8.2.4.2	Internal Size and Shape of Spacecraft in 0g.....	663
8.2.4.2.1	Determining Minimum Net Habitable Volume.....	663
8.2.4.2.2	Task Analysis Method.....	663
8.2.4.2.2.1	Experience-Based Method	668
8.2.4.2.2.2	Measurement of Net Habitable Volume.....	675
8.2.4.3	Internal Size and Shape of Spacecraft in Gravity Environments	675
8.2.4.3.1	Determining Spacecraft Size for Gravity Environments	676
8.2.4.3.2	Task Analysis Method.....	676
8.2.4.3.2.1	Experience-Based Method	676
8.2.5	Module Layout and Arrangement	679
8.2.5.1	Analysis Process.....	679
8.2.5.2	Mission Requirements and Task Definition	679
8.2.5.3	Overall Spacecraft Configuration.....	680
8.2.5.4	Design of Module Interiors	680
8.2.5.5	Detailed Design of Facilities	680
8.2.6	Multipurpose and Reconfigurable Spaces.....	681
8.2.7	Co-Location and Separation.....	681
8.2.8	Reconfiguration and Reuse.....	684
8.2.9	Considerations Specific for Capsules.....	684
8.2.9.1	Assessment of Capsule Stable 2 Configuration.....	684
8.2.9.1.1	Time to rescue and possible countermeasures.....	688
8.2.9.1.2	Treatment considerations.....	689
8.2.9.1.3	Effects of Long-duration Microgravity	689
8.2.9.1.4	Affecting Factors.....	690
8.2.9.1.5	Conclusions	690
8.2.10	Long-duration Spaceflight Considerations for Architecture	690
8.2.11	Research Needs	694
8.3	LOCATION AND ORIENTATION AIDS.....	695
8.3.1	Location Coding.....	695
8.3.2	Orientation.....	697
8.3.2.1	Architectural Features	698
8.3.2.2	Color and Shading.....	701
8.3.3	Research Needs	703
8.4	TRANSLATION PATHS	704
8.4.1	Introduction	704
8.4.2	General Considerations	704

8.4.3	Restraint and Mobility Aid Location	706
8.4.4	Research Needs	708
8.5	HATCHES AND DOORS	709
8.5.1	General Considerations	709
8.5.2	Research Needs	711
8.6	WINDOWS	712
8.6.1	Introduction	712
8.6.2	Window Design and Task Support.....	712
8.6.2.1	Window Categories	713
8.6.2.2	Minimum Number of Windows.....	716
8.6.2.3	Multipurpose Windows	716
8.6.2.4	Special-Purpose Windows	717
8.6.3	Window Location and Orientation	717
8.6.3.1	Window Visual Field	720
8.6.3.2	Window Vision (Fields of View) for Piloting.....	720
8.6.3.2.1.3.1	Side Vision Area Up-Vision Minimums.....	722
8.6.3.2.2.1.1	Forward Vision Area Up-Vision Minimums.....	724
8.6.3.3	Inboard Window View Obscuration Exclusion Zone.....	726
8.6.3.4	Outboard Window View Obscuration Exclusion Zone.....	727
8.6.3.5	Optical Uniformity	728
8.6.3.6	Window Shape	729
8.6.4	Surface Finish for Window Frame and Surrounding Structure	729
8.6.5	Window Surface Contamination	729
8.6.5.1	Material Selection and Contamination Prevention for Window Assembly and Installation	730
8.6.5.2	Molecular Contamination Removal for Category A, B, and C Windows.....	731
8.6.5.3	Particulate Contamination Removal for All Windows.....	732
8.6.5.4	External Contamination Monitoring for Category A, B, and C Windows.....	732
8.6.6	Other Sources of Window Contamination and Damage.....	732
8.6.6.1	Protective Panes and Covers	733
8.6.6.1.1	External Window Protection	733
8.6.6.1.1.1	Transparent External Protection.....	733
8.6.6.1.1.2	Opaque External Protection.....	733
8.6.6.1.2	Internal Window Protection	735
8.6.7	Condensation Prevention.....	737
8.6.7.1	Manual Operation of Condensation Prevention Systems.....	737
8.6.8	Window Transmittance and Non-Ionizing Radiation	737
8.6.8.1	Attenuation and Filtering of Non-ionizing Radiation	737
8.6.9	Window Support	738
8.6.9.1	Working Volume Around Windows	738
8.6.9.2	Electronic Connectivity for Window Support.....	738
8.6.9.3	Window Support in Microgravity	739
8.6.10	Research Needs	740
8.7	LIGHTING	741
8.7.1	Introduction	741
8.7.2	Lighting Terms and Units	741

8.7.2.1	Radiometric Power and Luminous Flux	743
8.7.2.2	Illuminance and Irradiance	743
8.7.2.3	Intensity	743
8.7.2.4	Photometric Luminance and Radiometric Radiance	746
8.7.2.5	Light Interaction with Surface Materials	746
8.7.2.5.1	Reflectance and Absorption	746
8.7.2.5.2	Transmission	756
8.7.2.5.3	Refraction	756
8.7.2.5.4	Contrast	756
8.7.3	Glare	756
8.7.3.1	Factors Affecting Glare Sensation	758
8.7.3.2	Glare Measurement	758
8.7.3.3	Glare Control	759
8.7.4	Lamps and Lighting Fixtures	760
8.7.4.1	Beam Pattern	760
8.7.4.2	Lamp Types	764
8.7.4.2.1	Lamp Color	764
8.7.4.3	Luminaires	766
8.7.5	Lighting Control	769
8.7.5.1	Control Location	769
8.7.5.2	Control Design	769
8.7.6	Lighting Color	770
8.7.7	Circadian Entrainment	772
8.7.8	Illumination for Dark Adaptation and Mesopic Vision	772
8.7.9	Signaling and Position Lights	773
8.7.9.1	Minimum Intensity	773
8.7.9.2	Apparent Intensity	773
8.7.9.3	Flash Rate	774
8.7.9.4	Signaling and Position Light Color	775
8.7.10	Lighting of Control Panel Legends	775
8.7.10.1	Indicator Luminance Settings	775
8.7.10.2	Indicator/Annunciator LED colors	776
8.7.10.3	Lamp Test Capability	778
8.7.10.4	LED Drive Current Control	778
8.7.11	Architectural Lighting System Design	779
8.7.11.1	Lighting System Design Process	780
8.7.11.2	Lighting Needs	782
8.7.11.3	Defining Minimum Lighting Levels	783
8.7.11.4	General Lighting	784
8.7.11.5	Fixtures for Lighting Tasks	785
8.7.11.6	Emergency Lighting	785
8.7.11.7	Integrating Overall Lighting	786
8.7.11.8	Lighting Analysis Techniques	786
8.7.11.8.1	Manual Lighting Analysis	786
8.7.11.8.1.1	Inverse Square Law Method (Illuminance at a Point)	786
8.7.11.8.1.2	Lumen Method (Zonal Cavity Method)	787

8.7.11.8.2	Software-Assisted Lighting and Graphical Analysis.....	790
8.7.12	Research Needs	792
8.8	REFERENCES	793

TABLE of FIGURES

Figure 8.2-1	Spacecraft architectural design drivers.....	660
Figure 8.2-2	Historical NASA spacecraft pressurized volume.....	669
Figure 8.2-3	Habitable floor area per crewmember vs. mission duration for undersea habitats.....	678
Figure 8.2-4	Illustration of the interior of the ISS Zvezda Service Module (JSC 2000-E-26922, 2000).....	682
Figure 8.2-5	ISS Russian Service Module with co-located dining table (left), treadmill (bottom), crew sleep quarters (left and right), and toilet (beyond treadmill).....	682
Figure 8.2-6	The image on the left is the approximate position of Orion seat in Stable 2. The image on the right is the Orion seat configuration in a nominal position.	685
Figure 8.2-7	OSHA-approved full body harness with D-ring attachment point in the mid-back, as studied by NIOSH (reproduced from Turner et al, 2008). ...	686
Figure 8.2-8	Soyuz seat. Note the higher degree of flexion in the hips and in the knees compared with the Orion seat in Figure 8.2-6.	689
Figure 8.3-1	Shuttle middeck location codes (Space Shuttle Program, 2004, JSC 26419).....	695
Figure 8.3-2	Shuttle flight deck location codes (Space Shuttle Program, 2004, JSC 26419).....	697
Figure 8.3-3	Orientation and the sagittal plane of a crewmember's head.....	699
Figure 8.3-4	Consistent orientation for equipment within a workstation or activity center	700
Figure 8.3-5	Left image: Architectural features promote reference planes (up and down) in 0g. Right image: No objects promote a sense of up and down.	700
Figure 8.3-6	Endcone paint and labels in the ISS modules Destiny (left) and Unity (right).	702
Figure 8.4-1	Traffic flow diagram.....	705
Figure 8.5-1	Initial concepts for hatch and door placement.	711
Figure 8.6-1	Calculation of visual angle from window.....	721
Figure 8.6-2	Forward vision area up- and down-vision for nonconformal windows.	725
Figure 8.6-3	Forward vision area up- and down-vision for conformal windows.	725
Figure 8.6-4	Inboard window view obscuration exclusion zone.....	726
Figure 8.6-5	Outboard window view obscuration exclusion zone.....	728
Figure 8.6-6	Window implementation in 0g.....	739
Figure 8.7-1	Lighting terms and units.	742
Figure 8.7-2	Light source beam pattern specification from manufacturer datasheet.	745
Figure 8.7-3	Illustration of specular and diffuse reflection.	747
Figure 8.7-4	Example reflectance spectrum (with ultraviolet light).	749
Figure 8.7-5	Example reflectance spectrum (without ultraviolet light).	750
Figure 8.7-6	Reflectance example (three light fixtures, 20% all surfaces).	752
Figure 8.7-7	Reflectance example (three light fixtures, 80% all surfaces).	753
Figure 8.7-8	Reflectance example (two light fixtures).	754
Figure 8.7-9	Reflectance example (two light fixtures, rotated 90 degrees).	755

Figure 8.7-10 Lighting glare	757
Figure 8.7-11 Spot beam pattern for LED lamp fixture	762
Figure 8.7-12 Flood beam pattern for LED lamp fixture	763
Figure 8.7-13 Spectral irradiance graphs for a variety of light sources.....	766
Figure 8.7-14 White LED light panel ISS prototype spectrum (measured).	766
Figure 8.7-15 Luminaire design examples.	768
Figure 8.7-16 Lighting control operation.	770
Figure 8.7-17 Lighting control movement and luminance	770
Figure 8.7-18 Dominant wavelength determination for LED and incandescent indicators.....	779
Figure 8.7-19 Lighting system design process.	781
Figure 8.7-20 Inverse square law point illuminance example.....	787
Figure 8.7-21 Zonal cavity method average illuminance worksheet.....	789
Figure 8.7-22 Radiance image showing glare in the orbital lighting environment.	791

TABLE of TABLES

Table 8.2-1 Body Volumes Associated with Operations in 0g.....	664
Table 8.2-1 Body Volumes Associated with Operations in 0g (continued).....	665
Table 8.2-1 Body Volumes Associated with Operations in 0g (continued).....	666
Table 8.2-1 Body Volumes Associated with Operations in 0g (continued).....	667
Table 8.2-1 Body Volumes Associated with Operations in 0g (continued).....	668
Table 8.2-2 Historical NASA Spacecraft Pressurized Volume.....	669
Table 8.2-3 Example Volume Dimensions for Spaceflight and Terrestrial Analogs	671
Table 8.2-3 Example Volume Dimensions for Spaceflight and Terrestrial Analogs (continued)	672
Table 8.2-4 Undersea Habitat Volume and Floor Area	677
Table 8.2-5 Habitat Design Guidance for Various Psychological Stressors.....	692
Table 8.3-1 Shuttle Flight Deck Location Codes.....	696
Table 8.6-1 Window Category Definitions.....	714
Table 8.6-2 Window Port Category vs. Instrument or Tasks Supported	714
Table 8.6-3 Considerations for the Location and Orientation of Windows within a Spacecraft vs. Window Tasking.....	717
Table 8.7-1 Glare Control.....	759
Table 8.7-2 Luminance Ratios for Workstations	760
Table 8.7-3. Comparison of dominant wavelength ranges for the example of Figure 8.7-18.....	777
Table 8.7-4 Minimum Lighting Level by Task.....	783

8 ARCHITECTURE

8.1 INTRODUCTION

This chapter includes a summary process and guidance for the development and integration of overall size and configuration, location and orientation aids, traffic flow and translation paths, hatches and doors, windows, and lighting. The content in this chapter primarily supports NASA-STD-3001, Volume 2, Sections 7 and 8.

8.2 OVERALL ARCHITECTURE DESIGN

8.2.1 Introduction

Architecture is a key enabler of the human system's well-being and ability to perform its tasks safely and effectively to accomplish mission goals. Any design must include unified solutions for transitions between tasks, and the interactions and conflicts of tasks that are adjacent either physically or temporally.

This section addresses the general size, placement, arrangement, and configuration of spaces in spacecraft crew stations, compartments, translation corridors, and other habitable volumes where crewmembers live and work. It includes design guidance for determining the configuration and nature of spacecraft volumes and surface areas, the co-location and/or separation of functional areas, the issues in designing multipurpose and reconfigurable volumes, and how different gravity environments are expected to affect the overall approach to spacecraft architectural design. It also includes design guidance for handling the architecture-related psychosocial issues involved in space exploration. Crewmembers of the International Space Station (ISS) have emphasized the importance of properly co-locating or separating functional areas for dining, exercise, work, hygiene, and sleep to ensure proper habitability on orbit. Unfortunately, the layout in some modules of the ISS has not always accommodated this type of optimal architectural design or volume configuration.

8.2.2 Architectural Design Drivers

Spacecraft architecture is unique in that it needs to meet the challenges of working and living in space. These challenges include, but are not limited to

- Variable gravity environments
- Mission objectives
- Crew size
- Limited mass and volume
- Stowage
- Extremes of mission duration
- Behavioral health factors
- Medical considerations
- Isolation

- Spacecraft unique tasks (e.g., exercise, body waste management, personal hygiene; see HIDH Chapter 7)

Figure 8.2-1 provides a high-level graphical representation of the interaction between these architectural design drivers, how these data are combined and considered in enabling determinations of volume, surface area, and architectural layouts – and how these elements are factored back into the design process as they continue to be refined.

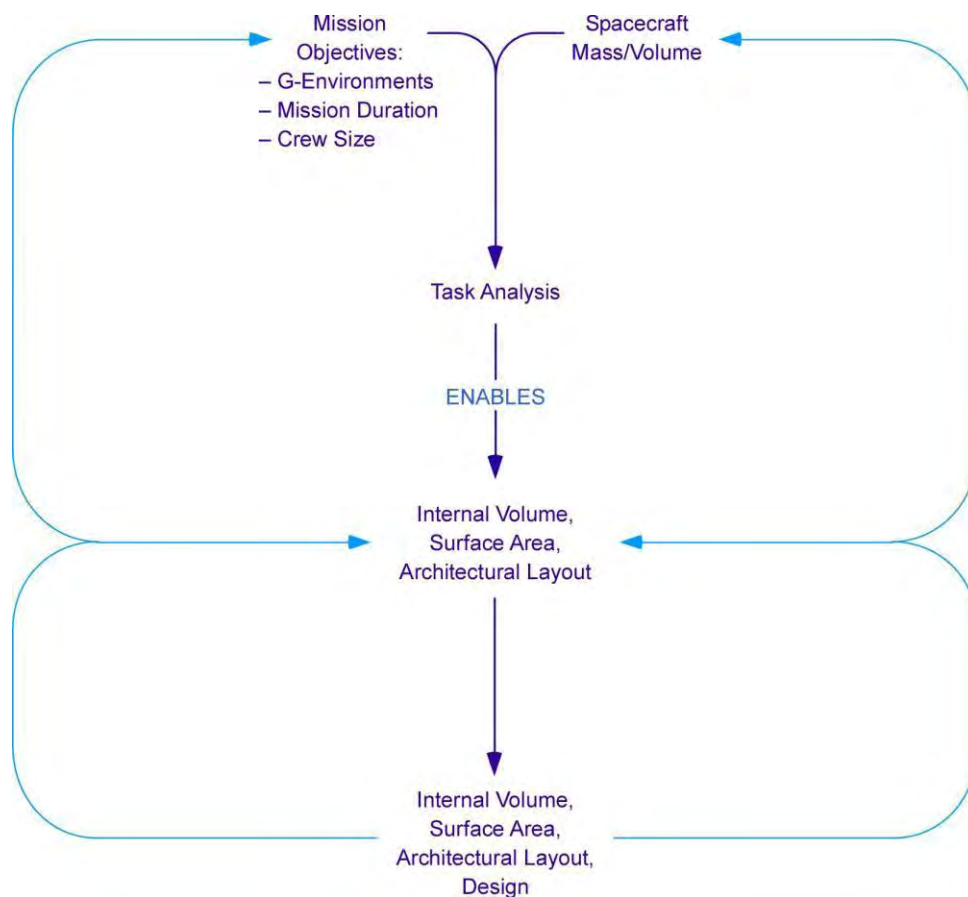


Figure 8.2-1 Spacecraft architectural design drivers.

8.2.3 Gravity Environments

Spacecraft need to be designed for habitation in one or more gravity environments, from 0g to 1g, and possibly greater. The following general factors should be considered when designing the overall layout of such spacecraft:

- Access – 0g and partial gravity may allow greater access to places that would otherwise not be accessible in 1g, such as “ceilings.” Conversely, a higher gravity environment may limit such access.
- Restraint – Many of the activities in 0g require that the individual be restrained, tethered, or otherwise secured in position. Restraints must be located where crewmembers can

secure themselves and do so in a reasonable amount of time, and where they can aid crew operations. (See section 8.4.3, “Restraints and Mobility Aid Location.”)

- Crew Mobility – In 0g, crewmembers primarily translate using their arms and hands, and by pushing off surfaces with their feet. This should be considered when designing mobility aids. Differences in crew mobility should be considered in partial-g environments. In some instances, crew mobility will be considered to be impaired, in others improved.
- Orientation – Changes in spacecraft and crew orientation from one gravity environment (e.g., 1g launch) to another (e.g., 0g in orbit, high-g entry) should be considered for the orientation of crew interfaces.

8.2.4 Internal Size and Shape of Spacecraft

8.2.4.1 General Factors That Affect Internal Size and Shape

While spacecraft external size and shape are dictated largely by aerodynamics and mass, the internal size and shape must be driven by the ability of the crew to perform tasks. Historically, spacecraft design has allocated specific volume and mass “not to exceed” requirements to individual systems and their accompanying hardware early in their conceptual design in an effort to align the spacecraft with propulsion capabilities, and to withstand the stresses of launch and landing. This approach leaves interior habitable volume as an artifact of whatever open, pressurized volume remains after all other hardware, stowage, and systems have been installed. This approach is inadequate, particularly as mission duration increases.

Adequate internal size, in terms of volume and surface area, must be provided to ensure that crewmembers can safely, efficiently, and effectively perform mission tasks including working, sleeping, eating, egress (exiting), ingress (entering), and tasks necessary for a safe and successful mission.

Defining the size and shape of a spacecraft depends on the gravity environment in which it operates. For spacecraft that will be used in partial-g, horizontal area is a good measure of size, just as floor space is used to assess architectural size on Earth. However, in 0g, since all surfaces may be equally used, area is not as meaningful a measure of size, and volume is typically used instead.

Several terms are used to describe spacecraft volume:

- Pressurized volume – the total volume within the pressure shell.
- Habitable volume – the volume remaining within the pressurized volume after accounting for all installed hardware and systems. This is sometimes called “sand volume,” since it is equivalent to the volume of sand that would fill the spacecraft after hardware and systems were installed, including gaps that are inaccessible to the crew (nooks and crannies).
- Net habitable volume (NHV) – the functional volume left available to the crew after accounting for the loss of volume due to deployed equipment, stowage, trash, and any other structural inefficiencies and gaps (nooks and crannies) that decrease the functional volume.

General factors that should be considered in the determination of a spacecraft internal size and shape include

- Number of crewmembers – The maximum expected number of crewmembers must be accommodated. For example, if a spacecraft is ever expected to fly eight crewmembers it must be able to accommodate eight crewmembers. ISS crewmembers have indicated that as the number of crewmembers increases, the need to provide additional exercise equipment, additions to the waste containment system, and an improved hygiene area increases. The number and type of exercise equipment needed along with the corresponding volume will be vehicle and mission specific (see HIDH Chapter 7.5). Spacecraft designs must also accommodate visiting crewmembers. On the ISS, habitable volume and resources (i.e., living, sleeping, and hygiene capabilities) have been strained by the presence of visiting crewmembers.
- Mission duration – The maximum expected number of mission days, including contingency days, must be accommodated. The number of mission days also affects the size of a spacecraft. The confinement, isolation, and stress that usually accompany a space mission tend to increase with mission duration. This creates a psychological need for more room. A sense of privacy as well as a need for personal space becomes more important over longer durations. The total required net habitable volume per crewmember and per total crew complement increases with duration.
- Tasks – The volume/area must be adequate for crewmembers to perform required tasks. Consideration should be given to crewmember movement as well as the selection, location, arrangement, grouping, and layout of equipment with which the crew needs to interface. Crew tasks and activities include system operation, crew personal activities, and system maintenance tasks.
- Physical dimensions and motions of the crew – Designs must accommodate the smallest to the largest of the crewmember population. Designs must also account for physical dimensions of suited crewmembers and of pressurized suited crewmembers in functional areas (see section 4.3 Anthropometry). In addition, designs must accommodate all motions made by crewmembers when performing tasks
- Gravity environments – Designs must accommodate all expected orientations and gravity environments. The volume of a spacecraft may be adequate for performing tasks on orbit, but that same volume may be too small or in the wrong orientation for performing tasks in a gravity field, since on orbit, the crew can assume any orientation to complete certain tasks. Conversely, a volume that is appropriate for partial-g or 1g tasks, such as a piloting workstation for launch, may be insufficient for tasks on orbit. This may also require the size to be assessed differently for each gravity environment: volume for 0g, and horizontal surface area for partial-g. In addition, usability is affected by both the unique motion and orientation needs for each gravity environment, and the different tasks to be performed during each mission phase. Therefore, each gravity environment that the spacecraft experiences, and the unique constraints and freedoms that each provides, should be considered in the design. For example:
 - Before flight – A spacecraft will need to provide ingress and egress paths for suited crewmembers in 1g and partial-g, seats and restraints to withstand launch accelerations, and displays and controls in the proper location and orientation to support launch tasks.

- Orbit and transit phases – The crew will perform tasks in 0g, and they will have greater flexibility to position and orient themselves. When determining the size and shape of a 0g spacecraft, the greater usability of ceilings and walls should be considered.
- Planetary operations – A spacecraft may need to support all mission tasks in a partial-g environment.

8.2.4.2 Internal Size and Shape of Spacecraft in 0g

In 0g, the crew is not constrained to one orientation, and it is possible for them to move freely in all directions and easily access surfaces in any location within the spacecraft. Therefore, spacecraft internal size for 0g should be based on volume, and specifically NHV, which is a measure of the volume that is accessible to the crew.

8.2.4.2.1 Determining Minimum Net Habitable Volume

Determining the minimum required NHV of a spacecraft is necessary to ensure that the crew has enough room to safely and effectively perform their duties. This begins with a basic understanding of the mission in terms of duration, gravity environment(s), number of crewmembers, equipment volumes, and tasks. Since minimum NHV will drive design of the overall spacecraft size, and possibly its shape, minimum NHV must be estimated early in the design phase.

Also, as designs mature, growth in subsystem mass and volume will usually cause subsystem volume to protrude into the habitable volume, so designers tend to add a growth factor onto NHV. However, whenever a subsystem carries a growth or uncertainty factor, a design will be produced that does not fit within the mass and volume constraints. It is the responsibility of the human factors analyst to ensure that the required NHV is met, even as subsystems grow, or to be able to demonstrate the risk of not meeting it.

Two methods to consider for determining minimum required NHV are

- Task analysis
- Experience-based

Below is a description of each method and data necessary to support the process. In most cases, using both methods may be best.

8.2.4.2.2 Task Analysis Method

The task analysis method determines the volume required for the tasks to be performed during the mission and combines, co-locates, or overlaps them as necessary to determine the total volume required in the spacecraft. This requires an understanding of crew anthropometric dimensions and required motions for each task. It is also important to understand when the crew will be wearing spacesuits (suited) and when they will not (unsuited). Early in the design phase, the specific tasks to be performed during the mission may be unknown. However, it is known that the spacecraft will have to accommodate basic human operations such as systems control, food preparation, eating, sleeping, waste management and hygiene, maintenance, and

extravehicular activity (EVA). From these basic known operations, a set of volume drivers can be derived and their volumes estimated, and consequently the overall system volume can be estimated.

Much of the analysis mentioned in this section is illustrated as a single crewmember performing a single activity in a single crew station. An effective process for determining volume considers the additive effect of multiple crewmembers. The volume needed for each crewmember's activity increases to allow for the interaction of the crewmembers and for safe ingress and egress to the worksite. Designers should not assume that the volume for any particular activity will not be encumbered by the presence of other crewmembers' volume. The interaction of planned activities throughout the mission should be addressed for their activity volume and location in the spacecraft. Activities that infringe on each other's volume should be avoided by scheduling or through design of the work volume size and configuration.

Table 8.2-1 below illustrates the general dimensions that one might anticipate for various operations a crewmember could perform in 0g (see also HIDH Chapter 7.5 for exercise volumes). These values illustrate dimensions based on the largest body size in the expected astronaut population. The designer will need to consider the anthropometric dimensions of the population assigned to their specific system. The designer also needs to take into consideration the multipurpose use of volume as mentioned above.

Table 8.2-1 Body Volumes Associated with Operations in 0g




Figures of Human Body Postures and Volumes	Applicable Functions	Dimensions (m)		Volume (m ³)
	Eating, sleeping, hand washing, personal office, radiation shelter, conference	H	2.06	2.69
		L	1.06	
		W	1.23	
	Shaving, grooming, oral hygiene	H	2.16	2.34
		L	0.88	
		W	1.23	

Table 8.2-1 Body Volumes Associated with Operations in 0g (continued)

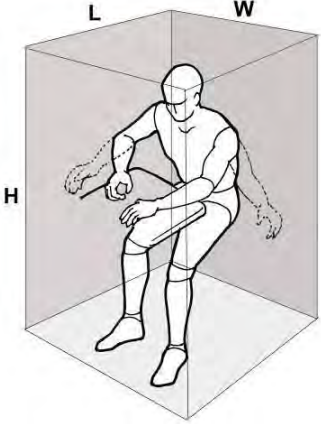

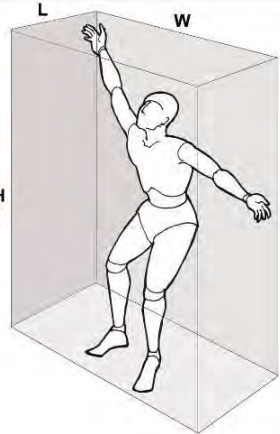
Figures of Human Body Postures and Volumes	Applicable Functions	Dimensions (m)		Volume (m ³)	
	General workstations, food preparation, partial body cleaning, housekeeping	H	2.06	4.34	
		L	1.06		
		W	1.99		
	Body waste management facilities, ascent and descent, spacecraft duty station	H	1.52	1.70	
		L	0.91		
		W	1.23		
	Food stowage, personal locker, accessing stowage	H	2.76	6.00	
		L	0.88		
		W	2.47		

Table 8.2-1 Body Volumes Associated with Operations in 0g (continued)

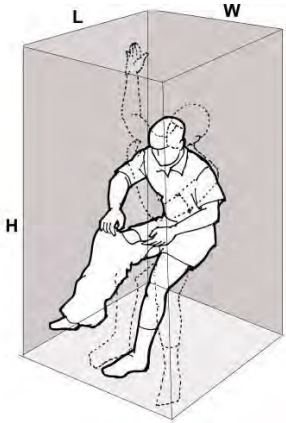
Figures of Human Body Postures and Volumes	Applicable Functions	Dimensions (m)		Volume (m ³)
	Dressing (don and doff), EVA suiting area	H	2.20	6.35
L		1.45		
W		1.99		

Table 8.2-1 Body Volumes Associated with Operations in 0g (continued)

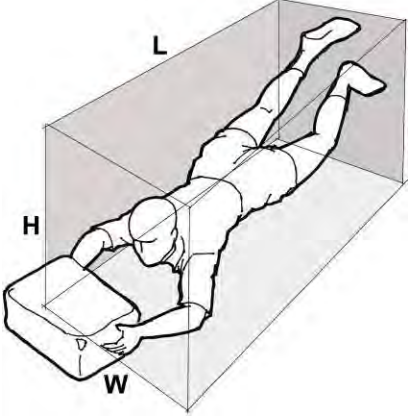
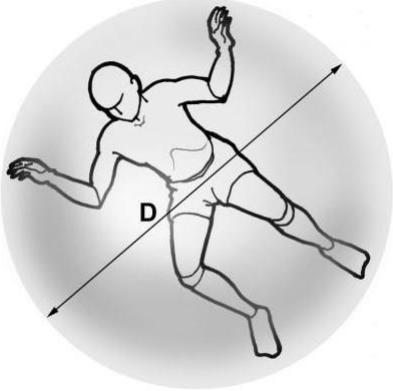

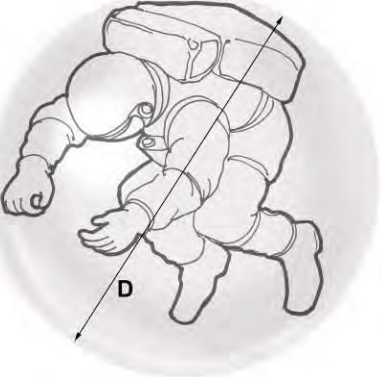
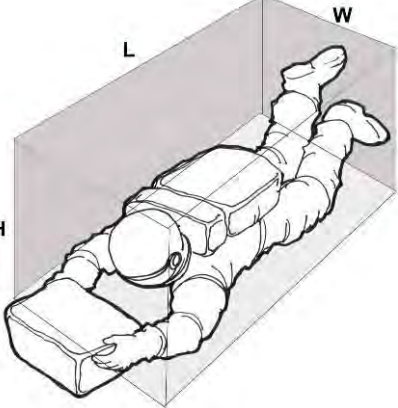
Figures of Human Body Postures and Volumes	Applicable Functions	Dimensions (m)		Volume (m ³)
	Egress, translation, passageways	H	0.70	2.55
L		2.96		
W		1.23		
	Uncontrolled tumbling	Spherical Diameter	2.44	7.61
	Controlled tumbling	Spherical Diameter	1.22	0.95

Table 8.2-1 Body Volumes Associated with Operations in 0g (continued)

Figures of Human Body Postures and Volumes	Applicable Functions	Dimensions (m)		Volume (m ³)
	Controlled tumbling with EVA suit on	Spherical Diameter	2.05	4.53
	Egress, translation, passageways, crew escape with EVA suit on	H	0.84	4.64
L	3.26	W	1.69	

Entries in **bold** are cubed root L-W-H dimension approximations.

8.2.4.2.2.1 Experience-Based Method

With the experience-based method, designers evaluate existing or previous spacecraft and the number of crewmembers and tasks (including the associated equipment and trash) to determine NHV per person, and then interpolate or extrapolate to the new mission and spacecraft. For example, to approximate the required NHV for a 3-person orbital spacecraft for missions on the order of a week, the Apollo Command Module (CM) and Russian Soyuz should be evaluated. The Apollo CM had 60% of its pressurized volume (10.4 m³) as NHV (6.17 m³). Soyuz had 58% (6.5 m³) as NHV (3.8 m³). (See Table 8.2-2 and Figure 8.2-2.)

Table 8.2-2 Historical NASA Spacecraft Pressurized Volume

Spacecraft	Crew	Crew Duration (days)	Press Volume (m ³)	Net Habitable Volume (m ³)**	Press Vol/Crew (m ³)
Mercury	1	1.4	1.4		1.4
Gemini	2	14	2.3		1.1
Apollo CM	3	10	10.4	6.17	3.5
Apollo Landing Module (LM)	2	3	8.0	3.77	4.0
Space Shuttle Orbiter (Overall - ISS Config)	7	16	74.8	16	10.7
Space Shuttle Middeck (ISS config, 7 crew, full)	4	16	N/A	10	*
Space Shuttle Forward Flight Deck	2	16	N/A	1.52	*
Space Shuttle Aft Flight Deck	1	16	N/A	4.2	*

* Value is not meaningful for this volume since crewmembers move from volume to volume based on activity

** Based on measurements taken at Space Center Houston (Apollo modules), JSC Building 9 Shuttle mockups, and graphical analysis

Ref. (Heineman, W. 1994)

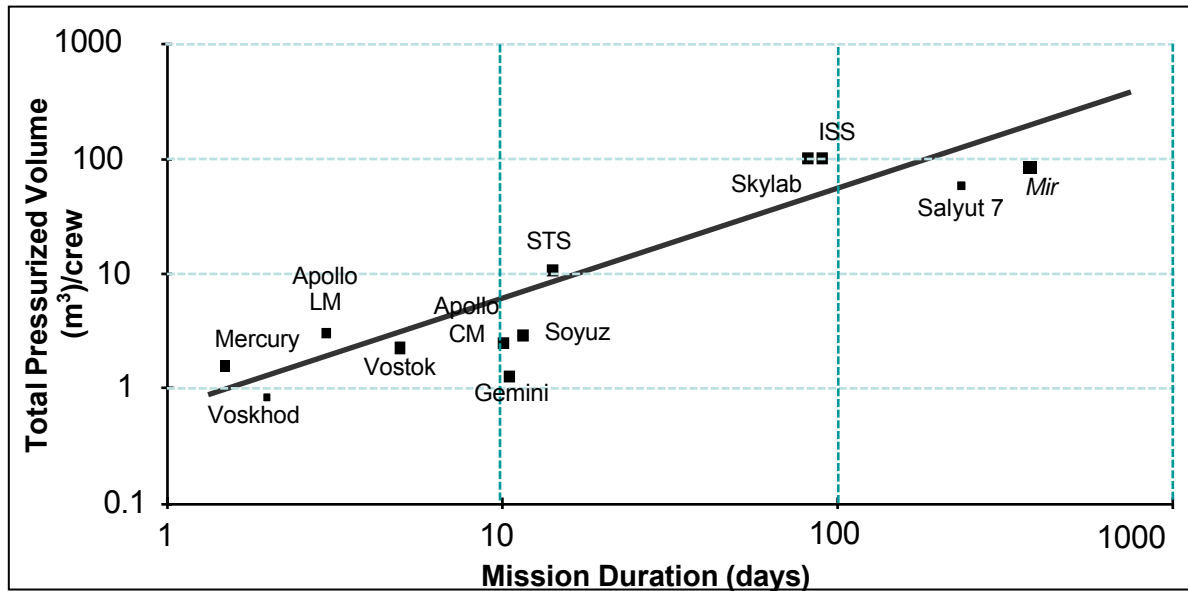


Figure 8.2-2 Historical NASA spacecraft pressurized volume.

Although 1g environments are not equivalent to 0g environments, the two have some similarities that could allow the use of terrestrial data:

- Given a ceiling that comfortably accommodates stature, a 1g volume roughly approximates the required 0g volume.

- The increase in required volume with mission duration is likely to be similar in both 1g and 0g environments.

Volumetric dimensions per activity for spaceflight analogs and 1g data are shown in Table 8.2-3 and Table 8.2-4 (in the following section).

A logarithmic (natural log) trend line for a habitat habitable volume (m^3) has the equation

$$\text{habitable volume per crewmember} = 6.67 \times (\text{duration in days}) - 7.79$$

This gives

$$\text{habitable volume per crewmember for 180 days} = 26.85 \text{ m}^3 (948.2 \text{ ft}^3)$$

$$\text{habitable volume per crewmember for 7 days} = 5.19 \text{ m}^3 (192.3 \text{ ft}^3)$$

These numbers can provide a starting point in determining the overall internal size of a spacecraft, but the actual size will depend on constraints on spacecraft shape, internal and external equipment, and layout of functional areas.

8.2.4.2.2.2 Measurement of Net Habitable Volume

Measurement of NHV is needed to

- Determine the volume of existing systems to serve as guidelines for future designs.
- Assess the progress of a design toward meeting an NHV goal.

Processes are defined for measurement of NHV from drawings and from actual hardware (completed systems or mockups).

The basic steps of the process are as follows:

- Divide the volume into simple, easily measured volumes. Measure and sum these volumes to determine total pressurized volume.
- Measure the volumes of enclosed equipment and stowed items, and subtract them from the pressurized volume.
- Assess cavities and voids and subtract the volume of unusable spaces from the pressurized volume. The final number will be the NHV value.

8.2.4.3 Internal Size and Shape of Spacecraft in Gravity Environments

In a gravity field, such as on the surface of the Moon or Mars, horizontal surface area, rather than volume, becomes more emphasized, since many work and support surfaces will be horizontal (chairs, tables, desks, beds, floors). Assuming the ceiling height is adequate, the measurement that assesses the available area in a spacecraft is the floor area. Whereas traditional Earth-based architecture can be described by the total floor area (i.e., square footage), this is not a complete or accurate representation of the functionality of the environment. A 2,000-square-foot house may be less functional than a 1,500-square-foot house, because of its overall layout and use of the area. However, for a house to be truly functional, intermediate horizontal areas, such as countertops, desks, and other pieces of furniture that provide usable surfaces, are required. The addition of furniture may reduce the amount of usable floor space but increase the amount of total horizontal space.

Although the Moon and Mars have sufficient gravity to define a “floor,” the need for ceiling height is still unclear. Images of movement in a lunar environment show a loping movement, and a “standard” ceiling height of 2.4 m (8 ft) may not be adequate. However, some aspects of how astronauts moved on the Moon during the Apollo Program will not apply to the interior of a spacecraft on the lunar or martian surface:

- Forward movement on the Moon was not restricted by walls.
- The spacesuit restricted movement, and this may have been compensated for with whole-body “bounding.”
- The suit mass increased the momentum of movements.

Conversely, a lower ceiling height may be useful to aid in mobility, by providing a surface to push off of with the hands. Additional research is needed to determine optimal lunar spacecraft ceiling height.

8.2.4.3.1 Determining Spacecraft Size for Gravity Environments

Similar to determining the minimum required NHV for 0g, determining the minimum horizontal surface area and its vertical height is necessary to ensure that crewmembers have enough room to safely and effectively move through the spacecraft, and enough work surface area to perform their duties. This begins with a basic understanding of the mission in terms of duration, gravity environment(s), number of crewmembers, equipment volumes, and tasks. Since minimum floor space will drive design of the overall system size, and possibly its shape, minimum floor space must be estimated early in the design phase.

Also, as designs mature, growth usually occurs in subsystem mass and volume that will cause them to protrude into the habitable areas, so designers tend to add a growth factor to the area. However, if every subsystem carries a growth or uncertainty factor, the result will be a design that does not fit within the mass and volume constraints. It is the responsibility of the human factors analyst to ensure that the required space needs are met, even as subsystems grow, or to be able to demonstrate the risk of not meeting them.

Two methods to consider for determining minimum required floor space are

- Task analysis
- Experience-based

Below is a description of each method and data necessary to support the process. In most cases, using both methods may be best.

8.2.4.3.2 Task Analysis Method

The task analysis method involves determining the horizontal area, including floor space and other horizontal surfaces, required for the tasks to be performed during the mission, and combining and overlapping them as necessary, to arrive at the total volume required in the spacecraft. This requires an understanding of crew anthropometric dimensions and required motions for each task. It is also important to understand when crewmembers are suited and unsuited. Information about the floor space required for various activities can be found in Table 8.2-3.

Early in the design phase, the specific tasks to be performed during the mission may be unknown. However, it is known that the spacecraft will have to accommodate basic human functions such as food preparation, eating, sleeping, waste management, and hygiene. Some basic mission tasks related to spacecraft control and EVA may also be known. From these basic known tasks, a set of floor space drivers can be derived. Looking at the timeline of the overall mission can help designers estimate where people will be at various times during a mission. This can serve as the basis for determining architectural space.

8.2.4.3.2.1 Experience-Based Method

With the experience-based method, designers evaluate existing or past spacecraft, crew size, and tasks to determine horizontal area per person, and then make an interpolation, extrapolation, or comparison to the new mission and spacecraft. A gravity field of any significant magnitude presents a relatively familiar environment, in that there is a relative “up” and “down” with respect to gravity and objects fall downward when not supported. Therefore, when looking to

previous experience to extrapolate to unfamiliar gravity environments, the most logical approach is to look at Earth-based analogs, as opposed to 0g spacecraft. The best analog for a Moon or Mars mission would be of the same approximate size, number of crewmembers, types of tasks, and mission duration of a lunar mission, with some subjective reporting on the habitability of the environment to determine if the spacecraft was adequate or needed improvement to be more habitable. Some analogs that include at least some of these key factors are undersea habitats, submarines, Antarctic stations, and recreational vehicles. Table 8.2-4 shows the volume and floor area for undersea habitats.

Table 8.2-4 Undersea Habitat Volume and Floor Area

Habitat	Maximal Duration (days)	Pressurized Volume (m³)	Habitable Volume per Person (m³)	Floor Area per Person (m²)
Conshelf II	21	78	12.8	5.4
Hydrolab	14	22.1	4.6	2.2
Conshelf III	21	78	12.8	5.4
Sealab II	30	178	15	5.75
BAH-1	14	18.8	7.9	4.2
Tektite I/II	59	125	19.2	7.2
La Chalupa	14	97.5	16.5	5.4
Aquarius	21	78	12.8	5.4

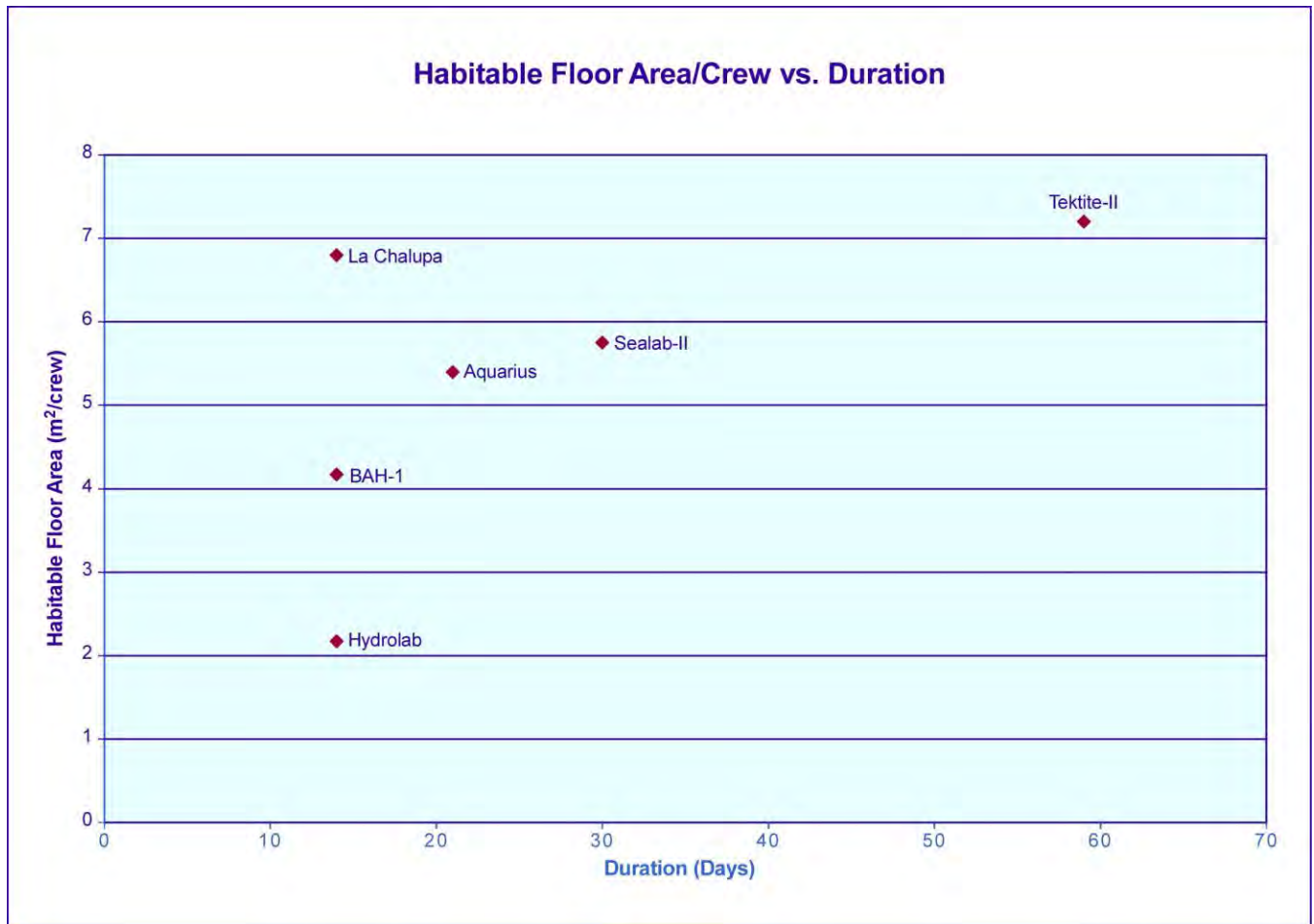


Figure 8.2-3 Habitable floor area per crewmember vs. mission duration for undersea habitats.

Given the assumption of a 4-person crew for a 180-day mission on the lunar surface, it is clear that any comparison with the above undersea habitats is limited by the duration. With ground analog data beyond 59 days being unavailable, it is unclear how a 3-fold increase in mission duration will affect required spacecraft size, so any extrapolation needs to be done with caution. However, for missions of shorter duration, such as 7-day lunar sortie missions, interpolation may be more accurate.

Although we know the number of crewmembers and the amount of habitable floor area for these undersea habitats, we have no indication of the subjective habitability of the environments, whether they were acceptable or not.

A logarithmic (natural log) trend line for the undersea habitat habitable floor area data has the equation

$$\text{habitable floor area per crewmember} = 2.27 \times \ln(\text{duration in days}) - 1.83$$

Given the above assumptions and caveats, an extrapolation of the trend line gives

- floor area per crewmember for 180 days = 9.96 m² (107.2 ft²)
- floor area per crewmember for 7 days = 2.59 m² (27.9 ft²)

These numbers can provide a starting point in determining the overall size of a spacecraft, but the actual size will depend on constraints on spacecraft shape, internal and external equipment, and layout of functional areas.

8.2.5 Module Layout and Arrangement

8.2.5.1 Analysis Process

When designing specific areas or features in architecture, it is often difficult for designers to know where to begin the process without first considering higher-level demands and requirements. For example, it can be difficult to place a window in a spacecraft if designers are uncertain what to base the positioning on, except general requirements such as window dimensions.

The hierarchy of the design process is as follows:

- Mission requirements (objectives, duration, crew size, location, etc.) and task definition
- Overall spacecraft configuration
- Interior module design
- Detailed facility design (windows, crew quarters, dining accommodations, etc.)

8.2.5.2 Mission Requirements and Task Definition

Equipment arrangement, grouping, and layout should enhance crew safety and interaction, and facilitate efficient operation. The module layout and arrangement should be based on detailed analyses using recognized human factors engineering techniques. This analysis process should include the following steps:

- Functional definition – Definition of the system functions that need to occur in the mission
- Functional allocation – Assignment of these functions to equipment, crewmembers, and crew stations
- Definition of tasks and operations – Determination of the characteristics of crew tasks and operations required to perform the functions, including
 - a. Frequency
 - b. Duration
 - c. Sequence
 - d. Volume required
 - e. Human motions required for operations
 - f. Potential for overlap or conflict in adjacent or overlapping operations
 - g. Special environmental requirements
 - h. Privacy and personal space
- Space module layout – Using the information determined above, the layout of the space module should
 - a. Minimize the transit time between related crew stations
 - b. Accommodate the expected levels of activity at each station
 - c. Isolate stations when necessary for crew health, safety, performance, and privacy

- d. Provide a safe, efficient, and comfortable work and living environment
- e. Minimize its impact on the spacecraft environment, including
 - 1) Glare due to placement of windows
 - 2) Blocking of ventilation by equipment
 - 3) Blocking of general lighting by equipment
 - 4) High noise levels from noisy equipment placed too close to habitable areas
 - 5) Excessive heat due to heat sources placed too close to crew stations

8.2.5.3 Overall Spacecraft Configuration

A multi-module spacecraft requires careful planning of the module combination since modules are likely to have different activities. The activities need to be arranged to support the spacecraft mission as defined above. The concept of zoning may be used to separate functional areas. It is recommended that the spacecraft configuration be divided into zones defining general high-level features such as

- Work zones (life science, exercise, workstations, etc.)
- Private zones (crew quarters, personal hygiene, private communication, waste management, etc.)
- Social areas (dining, galley, telecommunication, mission operations, entertainment, etc.)
- Dirty zones (heavy maintenance, planetary EVA activities, trash stowage, etc.)
- Clean zones (crew quarters, life science, galley; in general, areas that should not be exposed to any debris)
- Quiet zones (crew quarters, all private areas, recreation, etc.)
- Noisy zones (heavy work, maintenance, subsystems like Environmental Control and Life Support Subsystem, trash stowage, etc.)

Although many of these zones and functions may overlap, they should generally be distributed on the basis of optimal traffic flow and needs for co-location and separation (e.g., private zones should be near social areas, private zones should be in or near body waste management, and crew quarters should be far from noisy, heavy work areas).

8.2.5.4 Design of Module Interiors

To create solutions for module facilities, designers need to consider all surrounding influential aspects. These aspects may differ but are likely to be general operation, body envelopes, nearby traffic flow, nearby operation, nearby facilities, and environmental conditions.

8.2.5.5 Detailed Design of Facilities

To create detailed solutions for each facility, designers need to consider all surrounding influential aspects. These aspects may differ but are likely to be facility activity, facility operations, body envelopes, facility traffic flow, nearby activity, nearby facilities, and environmental conditions.

8.2.6 Multipurpose and Reconfigurable Spaces

Because most spacecraft have mass and volume constraints, designers should consider creating multipurpose or reconfigurable spaces that can increase the efficiency of a spacecraft interior, allowing different tasks to be performed in the same space. Similar to the ISS, these spaces may be used for stowage or activities such as sleeping or hygiene.

Co-located activities should be compatible in their human volume demands and their equipment volume and configuration demands. Also, activities should be able to be scheduled so that conflicting activities can occur at different times. The time and skills required to deploy, configure, and reconfigure such a space, however, should be minimized. For example, it should not take hours to change a meeting area into sleeping quarters. If it does, the crew will find alternative solutions, resulting in a less-than-ideal configuration.

Limitations on multipurpose use of a volume are as follows:

- **Compatibility** – Tasks should be compatible with surrounding areas and with each other, both physically and psychosocially. For example, the toilet should not serve a secondary function as a seat, because there may be competing demands for both uses, and because it may be unacceptable from psychosocial and contamination standpoints.
- **Hygiene and contamination** – One activity may contaminate another, such as body waste management and food preparation.
- **Time** – It may take too much time to efficiently convert the volume from one function to another.
- **Privacy infringement** – An activity may infringe on the privacy of a crewmember. This is the main objection to having two persons on different work shifts sharing the same quarters.

8.2.7 Co-Location and Separation

Workstations that perform related functions should be adjacent to each other, if possible. Activities performed at a workstation should be compatible with surrounding activities and facilities (e.g., non-interfering in terms of physical, visual, or acoustic considerations). Workstations should be separated or isolated if doing so improves the overall performance, safety, or privacy of the crewmembers.

The space environment provides numerous unique design constraints, but some aspects of architectural design are independent of the environment and should be considered as they are in terrestrial counterparts. Layout decisions should consider aspects of co-location or separation of functional areas. Co-location of certain functional areas has been problematic throughout long-duration space flight, including on the ISS. The location of sleeping quarters adjacent to the waste and hygiene facilities can disrupt crew sleep because of the noise made by the equipment. The co-location of dining facilities near exercise equipment and waste collection facilities can compromise sanitary and relaxing meals. On the ISS, the treadmill was deployed next to the galley/wardroom table, near the location of crew compartments. (See Figures 8.2-4 and 8.2-5.)

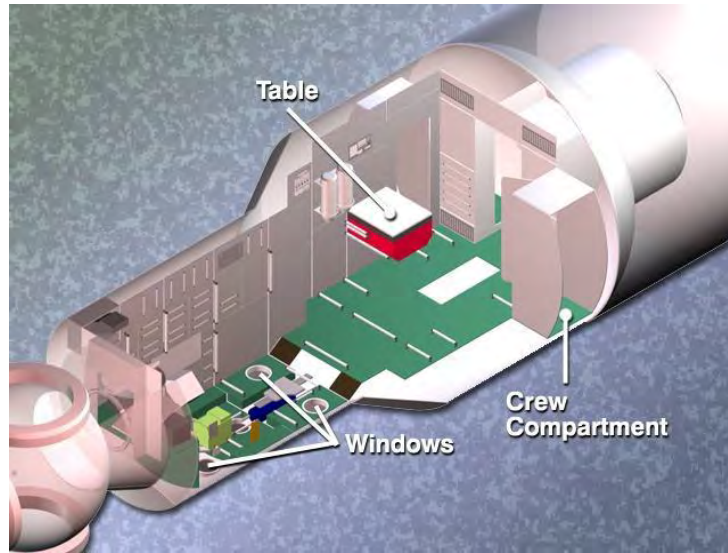


Figure 8.2-4 Illustration of the interior of the ISS Zvezda Service Module (JSC 2000-E-26922, 2000).



Figure 8.2-5 ISS Russian Service Module with co-located dining table (left), treadmill (bottom), crew sleep quarters (left and right), and toilet (beyond treadmill).

Locating dining facilities near laboratory work jeopardizes both habitability and the integrity of science activities. The integrity of science can be compromised by introduction of food debris and contamination of the controlled experiment environment. Frequently used translation passages have been blocked by large items, such as exercise equipment. Location of the dining table in a high-traffic area has made translation difficult. In the past, these areas have been co-located due to lack of availability of onboard habitation volume and resources. However, the nature of living in space has made this design concept sub-optimal. It will not be beneficial for future spacecraft designs because it presents numerous operational human hazards.

Considerations of co-location include

- Related Functions – Functional areas in which related functions are performed should be adjacent to each other, if possible. On the ISS, co-location of the exercise equipment, toilet, galley, and crew quarters in the Service Module was not ideal.
- Sequential Functions – Functional areas that are used to perform sequential functions should be co-located. Co-location of related, sequential functional work areas can reduce transit time, communication errors, and operational delays. For example, food stowage and food preparation areas should be located near one another, to minimize the time required to retrieve food for meals.
- Compatibility – Activities performed at a station should be compatible with surrounding activities and facilities (i.e., not interfere physically, visually, or acoustically).
- Proximity – Functional areas should be co-located when the functions or tasks performed in them need to be done in proximity to one another. For example, dual-piloting workstations that require interaction between crewmembers should be co-located, and food supplies should be located in or near the galley area to minimize the time needed to find items to prepare a meal.
- Transition Frequency – The frequency with which crewmembers switch from performing one function to another.
- Support Equipment Commonality – The percentage of support equipment shared by different functions.
- Traffic Interference – Some crew stations require a high volume of entering and exiting traffic (personnel or equipment). Placement of these stations adjacent to each other could result in traffic congestion and loss of efficiency.
- Lighting – Ambient illumination from one activity center may either interfere with or benefit the activities, such as experiments, sleep, or optical equipment, in an adjacent center.

Crew stations should be separated or isolated if it improves the overall performance and/or safety of the crewmembers.

- Contamination – The waste management system must be isolated from the galley to reduce the risk of fecal contamination of food.
- Physical Interference – Crew traffic flow, equipment movement, and activities of one station physically restrict the activities in another station.
- Environmental Interference – The activities in one station affect the surrounding environment so that the activities in an adjacent station are degraded. These environmental effects include lighting, noise, vibration, and heat.
 - Vibration – Certain activities, such as spacecraft control, robotics operations, and sleep, will be disturbed by vibrations and jolts. Crew stations for these activities should be isolated from significant sources of vibration.
- Noise Output and Sensitivity – Noise generated by crew activities and support equipment associated with one function has the potential to interfere with the performance of another function. Activities such as communications, sleeping and rest, and mental concentration are adversely affected by noise. Activities or facilities generating

significant noise levels should not be placed adjacent to crew stations that would be adversely affected by noise.

- Privacy – Certain personal activities such as sleeping, personal hygiene, waste management, and personnel interactions require some degree of privacy. Private areas where these activities occur should not be placed in passageways or highly congested activity centers. Additional degrees of isolation may be highly desirable, particularly in mixed-gender crews. As mission duration increases, the need for separation and privacy grows.
- Confidentiality – Some matters (e.g., medical conferences) require confidential communication and may require visual, auditory, or data isolation. This condition may exist for both crew-to-crew and crew-to-Earth interactions.

8.2.8 Reconfiguration and Reuse

Extended and variable use of spacecraft may require frequent reconfiguration during its lifetime. High launch costs limit the option of replacement. Architectural designs should consider both ease of reconfiguration and the reuse of resources.

RESERVED – sense of spaciousness, use of color and imagery for aesthetic appeal, cultural differences

8.2.9 Considerations Specific for Capsules

The stable 2 configuration is a specific concern for capsule landings, predicted to occur about 50% of the time based on Apollo landing data. The stable 2 configuration should be countered by an active uprighting system. One method used for Orion is called the crew module uprighting system (CMUS), in which post-landing balloons will deploy and inflate causing the vehicle to assume or maintain the stable 1 (upright) configuration.

8.2.9.1 Assessment of Capsule Stable 2 Configuration

JSC Space Medicine performed an assessment of the human system in the posture assumed when Orion is in the stable 2 configuration. Stable 2 will place suited, seated, and restrained crewmembers in a prone (face-down), head-up position for a period of time dependent on the functionality of the up-righting systems, ability of the crew to release themselves from the seat and restraints, and/or time to arrival of rescue forces. JSC Space Medicine assessed how long a healthy but deconditioned crewmember could stay in this prone, restrained position and the physiological consequences of this posture by researching terrestrial analogs and considered the known physiological alterations and deconditioning experienced by long-duration crewmembers.

Upon review of the medical literature, several terrestrial analogue populations were identified that may serve as a surrogate from which data could be extrapolated and recommendations made. The most applicable and analogous is that population which uses a full-body fall protection harness with a D-ring attachment point in the mid-back. Such harnesses are used for safety in

specific work environments as well as in certain recreational activities, encompassing workers at heights or at depths (industrial climbing, well construction), mountaineers, rock climbers, cavers, and parachutists, to mention just a few (Lee, 2007). All of these harness users are typically young to middle aged adults that are relatively healthy and fit, mirroring the astronaut corps. Another possible analogue population which has fewer similarities to the astronaut cadre is that of patients who are placed in a prone posture for surgery (spine, kidney, neurosurgery), recovery from surgery (closure of macular holes in the eye), or for prone ventilation strategies in critically ill patients with sepsis or Acute Respiratory Distress Syndrome (ARDS). This population group is less applicable to the astronauts in a stable 2 configuration, as such patients, aside from being far from healthy, are placed in a flat horizontal and occasionally slightly head-down posture, which is not physiologically equivalent to that assumed to occur with stable 2 seat position.

A rapidly incapacitating and potentially fatal medical syndrome has been described in occupational medicine and in wilderness medicine literature as occurring in harnessed individuals that have sustained a fall and have remained motionless in their harness for a period of minutes to hours (Orzech 1987, Roeggla 1996, Seddon 2002, Lee 2007, Roggla 2008, Turner 2008, Werntz 2008). This syndrome has received several names, including “Harness Hang Syndrome”, “Suspension Trauma”, and “Harness-induced Pathology” (Seddon 2002, Lee 2007, Werntz 2008, Turner 2008). This syndrome is caused by the body’s physiological response to a motionless posture that is either vertical or semi-prone, depending on where the harness attaches to the pulley/rope (Seddon 2002, Lee 2007), with the main underlying mechanism for its occurrence being orthostatic hypotension. The standard OSHA-approved fall-protection harness has the point of suspension in the mid-back (Turner 2008), yielding a body position that is similar to that of a restrained crewmember in a CEV seat in a stable 2 landing configuration (Figure 8.2-6). Stable 2 is not 180 degrees from Stable 1 due to the weighting of the toe of the vehicle, which causes the crew to be in a slightly head-up position. While most of the literature reviewed did not specify the angle at which subjects or victims were suspended, standards for full-body harnesses with a mid-back D-ring list angles of 30-50 degrees from vertical (Seddon 2002). Figure 8.2-7 shows a full body restraint system with a 41 degree angle from vertical (reproduced from Lee 2007).



Figure 8.2-6. The image on the left is the approximate position of Orion seat in Stable 2. The image on the right is the Orion seat configuration in a nominal position.



Figure 8.2-7. OSHA-approved full body harness with D-ring attachment point in the mid-back, as studied by NIOSH (reproduced from Turner et al, 2008).

HHS is described as developing within 5-30 minutes in a suspended person who is either immobilized or unconscious, with the key factor being lack of sufficient leg movement to generate a pump action for return of venous blood that has pooled in the legs to the heart (Seddon 2002, Turner 2008). In experimental subjects onset of symptoms is rapid (3.5 to 10 minutes), with one of the earliest signs being cognitive impairment which makes the suspended person less likely to assist with their own rescue (Werntz 2008). Symptoms start with general malaise, progressing to intense sweating, nausea, dizziness, hot flashes, brain function impairment that quickly worsens, respiratory difficulties, tachycardia, and progressively worsening arrhythmias, followed by a sudden increase in blood pressure and loss of consciousness (Lee 2007, Werntz 2008). Death is speculated to occur a few minutes after loss of consciousness if subjects are not quickly released from their harness (Werntz 2008). Case reports of HHS survivors also describe acute renal failure, coagulopathies, prolonged circulatory dysfunction, and long-term cognitive impairment; however these may have been due to other co-existing injuries in those reported cases (Roeggla 1996, Werntz 2008).

Studies done on harnessed individuals in a controlled simulated environment also report a rapid onset of symptoms, ranging from 3.5 to 10 minutes, with very few subjects (described as being particularly fit) able to tolerate the harness for 30 minutes without developing incapacitating symptoms (Werntz 2008). Loss of consciousness occurs after a range of 7-30 minutes (Lee 2007).

In another study, Roeggla et al evaluated the cardiorespiratory response to suspension in a chest harness and noted that after 3 minutes of suspension mean forced vital capacity decreased by 34%, mean forced expiratory volume decreased by 30%, mean end-tidal CO₂ increased by 12% (with no change in arterial oxygen saturation), mean heart rate decreased by 12%, mean systolic blood pressure decreased by 28%, mean diastolic pressure decreased by 13%, and mean cardiac output decreased by 36% (Roeggla 1996). The authors speculated that the underlying mechanism for the observed hemodynamic and respiratory impairment was not only gravity-

associated venous pooling, but that the rise in intra-thoracic pressure from chest strap pressure was the main mechanism, with activation of intracardiac reflexes (such as the Bezold-Jarisch reflex) as an explanation for the decrease in heart rate (Roeggla 1996).

Orzech et al conducted a study on three fall protection harnesses at the Harry G. Armstrong Aerospace Medical Research Laboratory, including a full body harness, to evaluate for physiological effects and subjective responses to prolonged, motionless suspension (Orzech 1987). Subjects tolerated the full-body harness suspension for a mean of 14.38 minutes (range 5.08 to 30.12 minutes) with symptoms of light-headedness and nausea being the most common causes for test termination (Orzech 1987).

In a study conducted by the National Institute for Occupational Safety and Health (NIOSH) by Turner et al (Turner 2008) subjects suspended in a full body harness with a back attach point (as shown in Figure 8.2-7) were found to have a 1.9 cm increase in midthigh circumference, a 1.5 L/min decrease in minute ventilation, a change in heart rate of 21.6 bpm, and a decrease in the mean arterial pressure of -2.6 mmHg. 95% of subjects tolerated the suspension for 11 minutes. 80% of tests were terminated for a medically-based tolerance limit, defined as either a decrease in systolic blood pressure of more than 20 mmHg, a decrease in diastolic blood pressure of more than 10 mmHg, an increase in heart rate of more than 28 bpm, a decrease in heart rate of more than 10 bpm, a pulse pressure decrease to less than 18 mmHg, or other signs and symptoms including shortness of breath, nausea, and dizziness (Turner 2008). Body weight was found to be a statistically significant determinant for length of tolerance time. No difference between genders was observed (Turner 2008).

The speculated physiological mechanisms underlying the Harness Hang Syndrome mainly include vascular and respiratory compromise and are briefly outlined below.

Vascular compromise

The major physiological driver of the adverse effects seen with HHS in a full body harness are thought to be related to gravity-associated pooling of venous blood in the lower extremities leading to a 20% decrease of the effective circulating blood volume and relative functional hypovolemia (Seddon 2002, Lee 2007, Werntz 2008) which results in orthostatic hypotension (increased heart rate and decreased blood pressure). Immobility of the legs reduces the return of blood to the heart, reducing preload and cardiac output, resulting in decreased perfusion of vital internal organs including the brain, leading to hypoxic injury (Seddon 2002, Lee 2007, Werntz 2008). Unlike cases of orthostatic hypotension where loss of consciousness leads to a fall and thus a horizontal position allowing for redistribution of the blood volume, a harnessed individual cannot assume a horizontal position and thus is unable to restore adequate perfusion (Seddon 2002, Lee 2007).

In addition, the thigh or groin straps that are part of a full-body harness are thought to compress the femoral veins and further decrease venous and lymphatic return from the legs (Seddon 2002, Lee 2007, Werntz 2008).

Respiratory compromise

Compression on the abdomen and thorax by the harness results in increased intra-thoracic and intra-abdominal pressures which will restrict the chest and diaphragmatic movement,

causing a decrease in ventilatory capacity, as evidenced by the decrease in pulmonary function tests as described above (Roeggla 1996, Werntz 2008).

Other contributing factors

Traumatic injuries, blood loss, dehydration, and other reasons for loss of consciousness that result in immobility of the lower extremities are all possible contributing factors to the phenomena seen with the HHS (Seddon 2002, Lee 2007).

8.2.9.1.1 Time to rescue and possible countermeasures

The literature notes that “a person who is motionless and suspended in a harness is a medical emergency, with only minutes to rescue the person to avoid HHS” and that all workplaces using harnesses should have a “concrete and rapidly employable rescue plan” because “waiting for off-site rescuers such as the fire department or rescue squad will result in too slow a rescue and is therefore an inadequate plan” (Werntz 2008). The National Institute for Occupational Safety and Health (NIOSH) recommends that “to ensure that no more than 5% of workers would experience symptoms rescue would have to occur in 11 minutes” (Turner 2008). The recommendation for cavers using a harness is to initiate a rescue plan within 3 minutes for a harnessed hanging caver who is either immobile or unable to resolve an equipment problem. Deconditioned crewmembers who are relatively dehydrated and more susceptible to orthostatic hypotension may become symptomatic sooner than is outlined for terrestrial populations. Since rescue ships may not be available for a few hours after CEV landing, it is vital that an up-righting system be employed within minutes.

An OSHA Safety and Health information Bulletin titled “Suspension Trauma/Orthostatic Intolerance” recommends that if rescue of harnessed hanging workers cannot be performed promptly, the workers should be trained to maintain frequent leg movements in order to use the leg muscles as a pump to reduce the risk of venous pooling. This may be difficult for a deconditioned crewmember who has become unaccustomed to the terrestrial force of gravity, and whose feet are restrained to the seat using toe holds or ankle straps, and who is also suffering from vestibular challenges in an awkward post-landing posture, and motion sickness from capsule movements on the water.

Another possible countermeasure is to shorten the vertical distance that blood needs to travel from the legs to the heart to overcome the orthostasis, for example by assuming a seated position with the legs flexed (Lee 2007). This is a similar posture to that of crewmembers seated in a Soyuz seat (Figure 8.2-8).



Figure 8.2-8. Soyuz seat. Note the higher degree of flexion in the hips and in the knees compared with the Orion seat in Figure 8.2-6.

8.2.9.1.2 Treatment considerations

There is no consensus on how to approach a harnessed suspended patient after rescue. Some authors advocate keeping a patient who has been suspended motionless for greater than 30 minutes in a seated position for 30 minutes after rescue and not placing them supine. Placing a suspension victim supine is thought by some to cause “rescue death”, which is speculated to occur due to hypoxic blood from the legs being re-introduced into the systemic circulation, causing ischemic heart failure. Right ventricular overload, reperfusion injury to organs that were hypoxic during the suspension, or release of toxins from the hypoxic blood that has stagnated in the legs are also speculated to play a role in “rescue death” (Seddon 2002, Lee 2007, Werntz 2008). This may be a consideration in rescue scenarios of crewmembers if the vehicle and crew remain in stable 2 for an extended period of time.

8.2.9.1.3 Effects of Long-duration Microgravity

Astronauts that have completed long-duration missions return to Earth in a deconditioned state. This deconditioned state is punctuated by decreased orthostatic tolerance, muscle strength, aerobic capacity and bone density, and alterations in the neurovestibular system which is easily provoked by head motion post flight resulting in disorientation, nausea, and vomiting. Long-duration crewmembers have also reported that their somatosensory capability is initially impaired. This means that their ability to use their muscles is affected and their motions are not fluid or well choreographed. So, an individual may want their arms and legs to execute certain maneuvers but the body is incapable of it due to the lack of familiarity with gravity and their own weight. This effect is reversed rapidly after the exposure to gravity, within minutes to hours, but it causes a crewmember’s physical activity to be initially precariously uncoordinated. This is eluded to by Skylab astronauts in the Skylab Medial Operations Project report (NASA/TM-2009-

214790; p.47) and reported by a long-duration ISS crewmember (personal communication). Taken together, deconditioning can manifest in several different ways leaving the crewmembers vulnerable to injury and without physiological reserve. Any nominally planned post landing activities should be sensitive to these vulnerabilities and not unduly stress the crew.

8.2.9.1.4 Affecting Factors

There are several factors that affect the severity of the harness hang syndrome and/or may produce different effects than those reported by the studies above. These are as follows:

- crewmembers may not be positioned as upright as the subjects in the studies;
- crewmembers may have the opportunity to push against a footboard to cause muscular contraction and encourage blood flow;
- a suit may provide some protection from pressure points caused by the restraint system which could cause blood flow restriction;
- crewmember body weight maybe distributed more uniformly across the restraint system preventing pressure points;
- crewmembers are significantly more physiologically vulnerable after a long-duration mission to the effects of the posture caused by stable 2;
- the cabin and in-suit environment may contribute to physiological compromise via thermal stress;
- sea state exacerbates neuro-vestibular disturbance

8.2.9.1.5 Conclusions

Based on the review of several terrestrial studies and the documented deconditioning of long-duration crewmembers, JSC Space Medicine has identified that symptom onset will occur in 3.5 minutes. Crewmembers will need to know if an up-righting system is active or failed within this time frame in order to determine the best course of action before cognitive deficits begin. The vehicle should be capable of up-righting itself within 7 minutes. If the system has failed the crew will have to remove themselves from the restraints to prevent worsening of symptoms and potential incapacitation. Crewmembers may be injured if they must release themselves from the restraints and the risk of injury is significantly increased when the vehicle is up-righted while the crew is not restrained. Finally, if the crew is exposed to the stable 2 posture for an extended duration (15 minutes or more), the rescue will have to be treated as a medical emergency.

8.2.10 Long-duration Spaceflight Considerations for Architecture

Designing architecture for long-duration spaceflight missions requires consideration of additional factors that may not be as critical for short-duration missions. Long-duration missions are defined in this section as those exceeding 30 days in duration, but it is important to note that there may be a need for even more focus on long-duration factors for missions that far exceed 30 days. Areas of focus for long-duration spaceflight considerations include habitability and human factors, along with other concerns such as communication delays, behavioral health and performance, and physiological and medical concerns. This section focuses on long-duration spaceflight considerations specifically as they impact vehicle architecture and volume.

The design of space vehicles and crew habitats can greatly affect habitability in terms of physical and psychological needs and comfort. Sources of discomfort may include inadequate volume in which to live and work, auditory interference with privacy and tasks, olfactory distress, frustration over confusing hardware and software interfaces, and other stressors (Beaubien & Baker, 2002). These sources of discomfort become even more important given the isolated conditions crewmembers of long-duration spaceflight missions will have to endure (Celentano, Amorelli, & Freeman, 1963; Connors, Harrison, & Atkins, 1985; Fraser, 1968; Harrison & Connors, 1990; Stuster, 1996, 2000, 2010; Whitmore, Adolf, & Woolford, 2000; Whitmore, McQuilkin, & Woolford, 1998). Research has found that isolated conditions tend to affect several areas of human function such as sleep cycles, immune functions, and psychological adaptation to the environment (American Bureau of Shipping, 2001; Lane & Feedback, 2002). Any of these areas have the potential to contribute to reductions in crew safety, introduction of inefficiencies, and reduced satisfaction.

Some initial impacts to volume and layout in spacecraft designed for long-duration missions are related to logistics and subsystems (Fraser, 1968). For example, longer missions require more supplies such as food and clothing. Implementation details of the mission will determine whether these needs impact vehicle volume and layout, but these concepts must be taken into consideration during vehicle design. Long-duration missions may also result in different requirements for subsystems such as environmental control and life support systems, the placement of which may have impacts on the volume available to crewmembers. Increased stowage needs for long-duration missions are also a concern related to habitability (Novak, 2000).

Increased mission durations may also impact the volume required for some crewmember tasks. Specific tasks affected and the level of impact are not currently defined, but it is important to consider potential effects of increased mission duration on crewmember tasks in terms of volume required to perform tasks, frequency of task performance, and other task attributes examined during a task analysis. For example, increased mission duration may lead to changes in exercise protocols, which may in turn impact volume allocations and scheduling decisions related to the activity. Similarly, details related to hygiene activities might be impacted by mission duration, with accompanying changes to vehicle configuration to accommodate task requirements. These serve as examples of tasks that may differ in long-duration missions, but designers must consider the full array of crewmember tasks in the context of mission duration during the design phase.

Beyond the minimum volume required to physically perform each task, it is important to consider behavioral health implications of vehicle volume and layout, especially for long-duration missions. Psychological stressors impacting habitat design include concerns such as allocation of space, workspace attributes, general and individual control of the environment, sensory deprivation and monotony, social monotony, crew composition, physiological and medical issues, and contingency readiness (Simon, Whitmire, Otto, & Neubek, 2001). These stressors were discussed at the Habitable Volume Workshop, which took place in Houston, Texas, April 18 – 21, 2011. Table 8.2-5 provides a summary of psychological stressors and corresponding habitat design guidelines as discussed at this workshop. This table serves to

provide a list of considerations and potential guidelines, but the table should not be interpreted as a comprehensive list of behavioral health concerns or required habitat design rules.

Table 8.2-5 Habitat Design Guidance for Various Psychological Stressors

Psychological Stressor Category	Habitat Design Guidance
Lack of Personal Space / Lack of Private Space	Provide individual, separate sleeping/personal quarters w/auditory isolation (mandatory) and physical separation (if possible) for each crew member
	Isolated locations throughout the vehicle
	Separation of private spaces from spaces allocated for common, social areas and congested translation paths is preferred
	Visual separation of private spaces from each other to allow for perception of increased privacy
	Rotating shifts
Feeling of "Crowdedness"	Separation of high traffic function
	Appropriate task scheduling/ task location
	Dedicated translation paths in integrated environment
	Increased volume or other dimensions to increased actual/perceived space
	Rotating shifts
Lack of Privacy of Waste & Hygiene Compartment	Dedicated, private area for waste and hygiene with hygiene areas away from dining area and medical station
	Separation of Waste & Hygiene Compartment area from translation areas
Lack of Meaningful Work/Activity	Provide individual development plans for each person's work goals, progress, and achievements
	Allocation of space and resources to accommodate each individual's work and activities (i.e., science, laboratory equipment, electronic curriculum, etc.). Each individual should have his or her own workspace and materials should be appropriately placed for ease of use and improved functionality
	Volume will be needed to hold samples and toolkits for in-flight experiments. Other features to impact volume may include electronic equipment to store data (workstations and hard drives) and a telescope. Equipment needed for analysis of collected samples during inbound flight.
Sense of Poorly Placed Stowage	Ensure stowage types are near designated areas (i.e., food near dining)
	Ensure that not all materials are stowed in one place

Psychological Stressor Category	Habitat Design Guidance
Lack of Individual Controls Over Temperature, Ventilation or Lighting	Place individual controls and distribution vents in crew quarters and at workstations
Lack of Reconfigurability for Cultural Difference / Personal Space Preferences	Reconfigurable packaging for crew accommodations and furniture
	Modular design with multiple applicable locations for multiple activities
Lack of Stimulation/Sensory Variability	Windows (Provide visual stimulation of high quality close to Earth, but limited utility on long-duration transit missions)
	Virtual Windows - Camera with projections of space, video of terrestrial footage, telescope,
	"Holodeck" or other virtually immersive environment
	Increased spatial vista within habitat
	Lighting, colors, and other visual countermeasures to increase sensory stimulation
	Greenhouse or other introduction of plants and natural elements for tactile, visual, gustatory, olfactory
	Different surfaces in the interior to maintain tactile senses
	Provision of musical instruments and music selection to counteract auditory
Social Deprivation / Lack of Common Areas	Enhance exercise system to include virtual experience
	Allocation of space for exercise equipment and "stretch-out" room
	A common area for recreation, large enough to accommodate all crewmembers inside at the same time
	Include 'television' (or equivalent) for crew to watch movies together (movies in the form of data can be transmitted from Earth to also provide sensory stimulation)
	A common area for dining, large enough to accommodate all crewmembers dining inside at the same time. This can be the same as the common area for recreation (converted). Kitchen required for food preparation.
Limited Communication with Home	Communication system should be provided in each private quarter
	System that facilitates voice and text should be provided
	Space for a "holodeck" to provide visual and auditory connection with loved ones at home.
	Private space with pictures of family members

Psychological Stressor Category	Habitat Design Guidance
Crew Composition	Characteristics of the crew (team size, gender makeup, job roles, and cultural backgrounds), which are established prior to the mission and will not change as a result of the mission, should be considered when defining the habitat requirements.
Lack of Hygiene Separation	Provide separation between clean areas (medical treatment, food prep, crew quarters, etc.) and dirty areas (hygiene, dusty areas, etc.) Medical treatment area may need to be separate as a biological contaminant (dirty) and a sterile (clean) area.
	Provide olfactory or other partitions to prevent contamination of clean areas. This can include closed, separately ventilated areas.
Lack of "Backup Plan" / "Rescue Scenario"	Recommendation to have separate modules (recommendation for redundant ships, that are connected; two Orion vehicles with station module in the middle.)
	Placement of hatches to allow for alternate escape routes.
	Provision of radiation shelter

As is true for spaceflight missions of any duration, for long-duration missions it is just as important to consider the layout and configuration of equipment as it is to consider the total volume available to crewmembers. Optimized layout will take into account task frequencies, task criticality, sequences of tasks, and functional grouping (Sanders & McCormick, 1993). For long-duration missions, designers should consider ways in which tasks or equipment may be changed when compared to shorter-duration missions. Layout of hardware is based on task analysis and Concepts of Operations, which must be documented as assumptions, even early in the design process.

8.2.11 Research Needs

- To provide consistency in design work across subsystems, it is necessary to start with a standardized list of volume-driving tasks. This list should include anticipated tasks for a variety of design reference missions and note which tasks will be particularly important to consider for long-duration missions. This list should also include subsystems that are expected to be impacted by long-duration missions, which, in turn, will affect volume and layout of vehicles. Examples might include increased stowage needs or additional food and clothing.
- This document defines long-duration as greater than 30 days. However, it is likely that another classification of long-duration missions is needed. Currently, a defined cutoff for an additional level of long-duration missions does not exist, but this should be addressed in forward work.

8.3 LOCATION AND ORIENTATION AIDS

This section provides design guidelines, applicable to all gravity environments, for location and orientation aids.

8.3.1 Location Coding

Spacecraft must use a standard location coding system to provide a unique identifier for each predefined location within the spacecraft. Location coding provides a clear method of referring to different locations in the spacecraft, and serves as a communication and situational awareness tool for crewmembers traversing the spacecraft or unstowing or stowing equipment. An example of Shuttle location coding is the numbering of middeck lockers, as defined in JSC 26419 (Space Shuttle Program, 2004): locker MF28H is located on the middeck (M), forward (F) surface, 28% of the way to the right of the total width of the surface, and 48 in. (122 cm) from the top of the surface (H indicates 8 alphabetic increments of 6 in. (15.2 cm) from the top) (Figure 8.3-1).

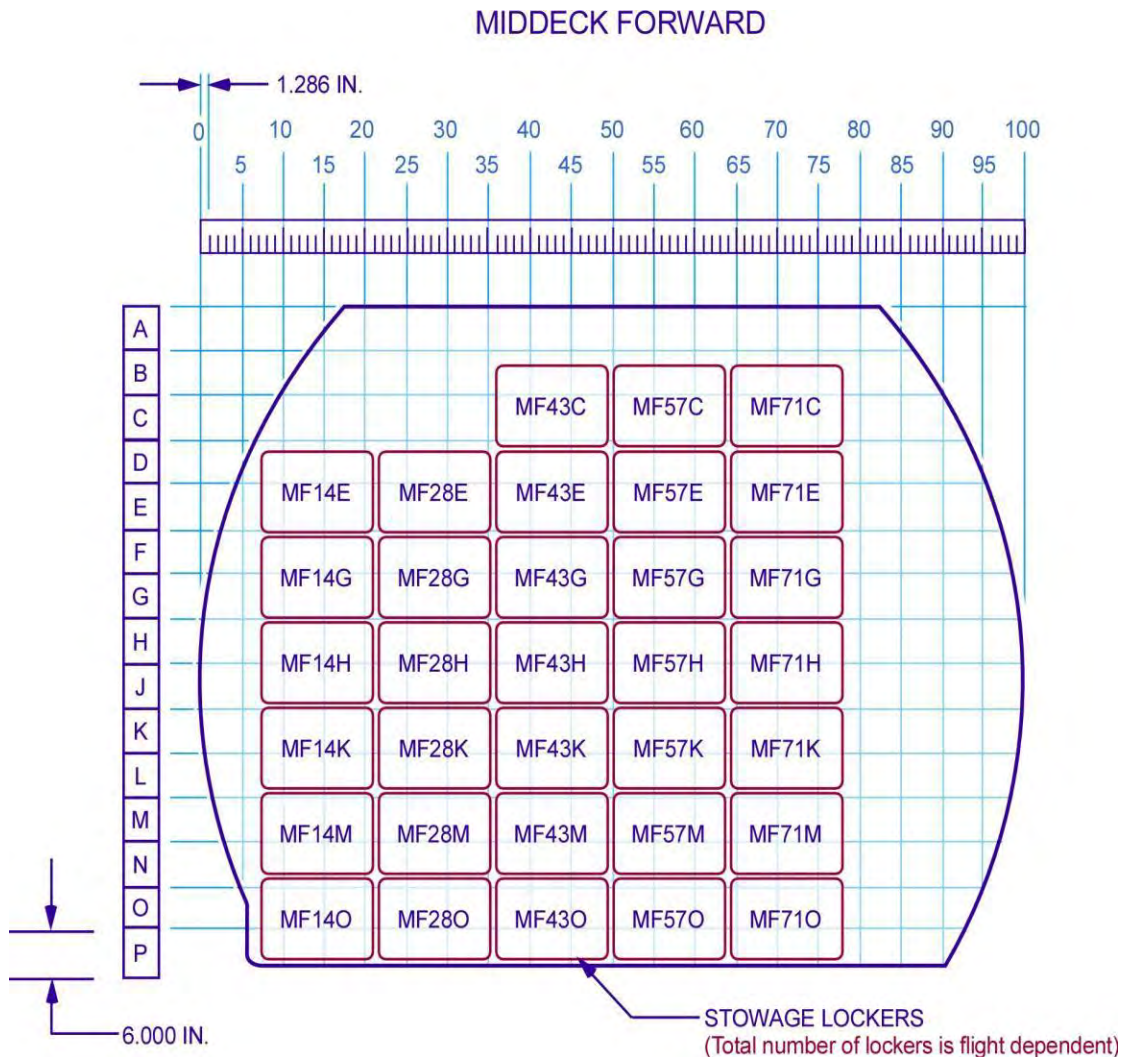


Figure 8.3-1 Shuttle middeck location codes (Space Shuttle Program, 2004, JSC 26419).

The flight deck has a slightly different coding scheme, due to the presence of windows, displays, and controls at the pilot workstations, and is defined in Table 8.3-1 and Figure 8.3-2.

Table 8.3-1 Shuttle Flight Deck Location Codes

Surfaces	General Numbering Philosophy
L – Left R – Right C – Center console	<ul style="list-style-type: none"> Numbered from top to bottom, forward to aft
O – Overhead	<ul style="list-style-type: none"> Numbered from left to right, forward to aft
F – Forward A – Aft	<ul style="list-style-type: none"> Numbered from left to right, top to bottom (facing the surface)
W – Windows	<ul style="list-style-type: none"> The forward windows are numbered left to right (W1 through W6) facing forward The overhead windows are numbered left to right (W7 and W8) facing aft The aft windows are numbered left to right (W9 and W10) facing aft
S – Seats	<ul style="list-style-type: none"> The CDR's seat is <u>S1</u> and the PLT's seat is <u>S2</u>

From (Space Shuttle Program, 2004) (JSC 26419).

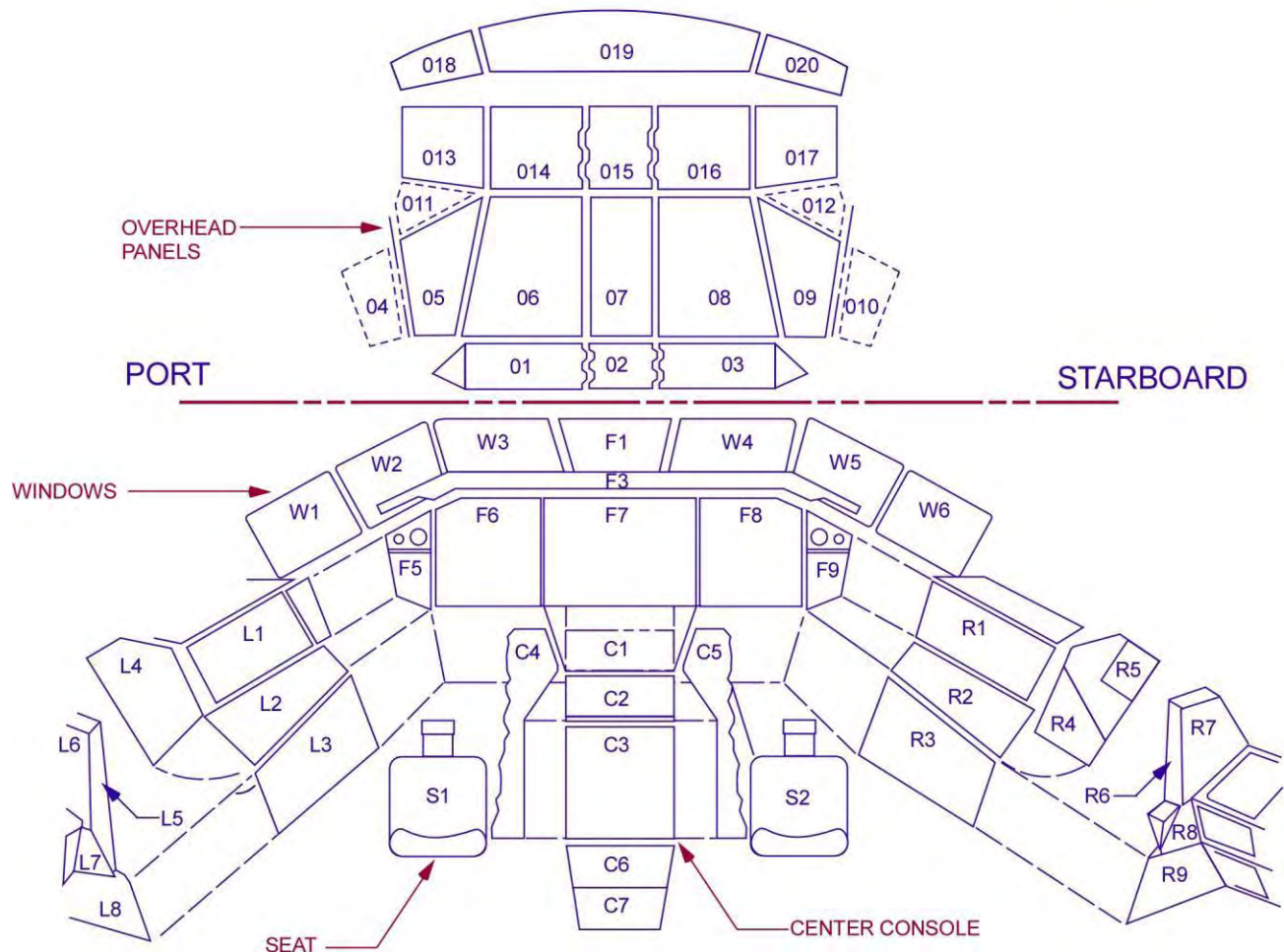


Figure 8.3-2 Shuttle flight deck location codes (Space Shuttle Program, 2004, JSC 26419).

8.3.2 Orientation

Consistent orientation within crew workstations must be included in the design to minimize crew disorientation and to facilitate crew performance. Whenever possible in 0g, a consistent directional orientation should be established between workstations and for the overall spacecraft. Whereas this is assumed for a 1g environment, in a 0g environment, the human working position may or may not be more flexible.

Improper orientation can result in

- Spatial disorientation
- Decreased crew performance
- Space motion sickness
- Unsafe emergency operations

Proper orientation will result in

- Increased work performance.

- Faster location of equipment and adjacent working stations and modules.
- Safer emergency situations.

In 1g, orientation is based primarily on gravity and visual scene polarity. On Earth, visual cues, such as buildings, trees, and people, normally align with gravity in an expected manner. A familiar visual environment such as a face or printed text is difficult to recognize when it is tilted by more than about 60° (Corballis et al., 1978). In 0g, where both the crewmembers and objects in the environment can be in any orientation, unfamiliar angles often occur. This often leads to spatial disorientation in crewmembers, which can lead to motion sickness and confusion, resulting in reduced crew performance, and this situation could become dangerous during an emergency. Disorientation can also occur in gravity environments, but it typically occurs in environments where direct line of sight to multiple adjacent areas is not possible. Proper orientation and location awareness are important for performing tasks such as locating equipment and moving from one area to another. Spacecraft should be designed to enhance orientation and location awareness, which depend on the gravity environment and spacecraft size.

8.3.2.1 Architectural Features

Architectural features can provide strong visual cues to aid in orientation by defining horizontal and vertical reference planes.

Examples of general architectural features that can create visual planes include:

- Interior construction
- Walls, ceiling, and floor
- Workstations and work surfaces
- Stowage and supplies
- Hatches and windows (not round)
- Ducting
- Lighting
- Chairs and tables

Orientation should be defined primarily through visual and operational cues. Several orientation factors should be considered when designing a 0g environment:

- Orientation of Workstation Elements – Workstations must provide user interface elements with the same orientation in roll as the sagittal plane of the crewmember’s head (Figure 8.3-3). Maintaining a consistent orientation of workstation elements minimizes crewmember rotational realignments needed to perform tasks, such as reading labels and displays, that have directionally dependent components. Inconsistent and varied display and control orientations may contribute to operational delays and errors. Given the complexity of some operations (e.g., piloting), a single orientation for all controls, displays, and labels may not be possible, but every effort should be made in design to minimize crewmember repositioning required to efficiently perform a task. Primarily a concern in 0g, this is meant to ensure that all equipment at a workstation is aligned with the crewmember's head, even if the head is turned, so that operating crewmembers only need to adjust their body orientation slightly in pitch and yaw at a workstation, but do not

need to adjust their body orientation in roll. As shown in Figure 8.3-4, workstations in the same area should share the same orientation.

- Visual Demarcations – Visual demarcations for adjacent workstations must be provided, to prevent incorrect use of adjacent workstation elements. Examples are physical indentation, color coding, or outlining.
- Visual Orientation Cues – Crewmembers need easy-to-read visual cues to help them quickly adjust their orientation to a “normal” position. These visual cues should define a horizontal or vertical reference plane.
 - Within a crew station, visual cues allow quick adjustment to the orientation to allow efficient performance.
 - When adjacent crew stations have vertical orientations differing by 45° or greater, visual demarcations are needed to prevent inadvertent use of other workstation elements.
- Operational Cues – By providing a seamless transition in orientations between volumes, functions, and tasks, a space’s architecture can provide an intuitive and natural-seeming system of cues.

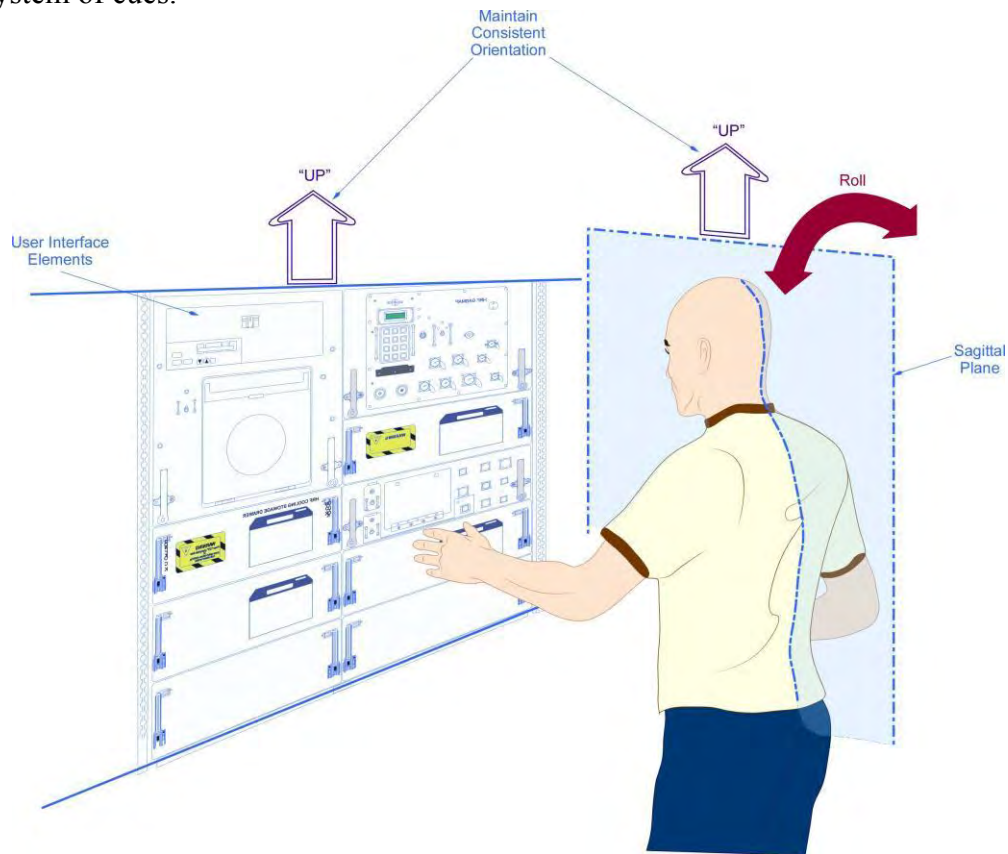


Figure 8.3-3 Orientation and the sagittal plane of a crewmember’s head.

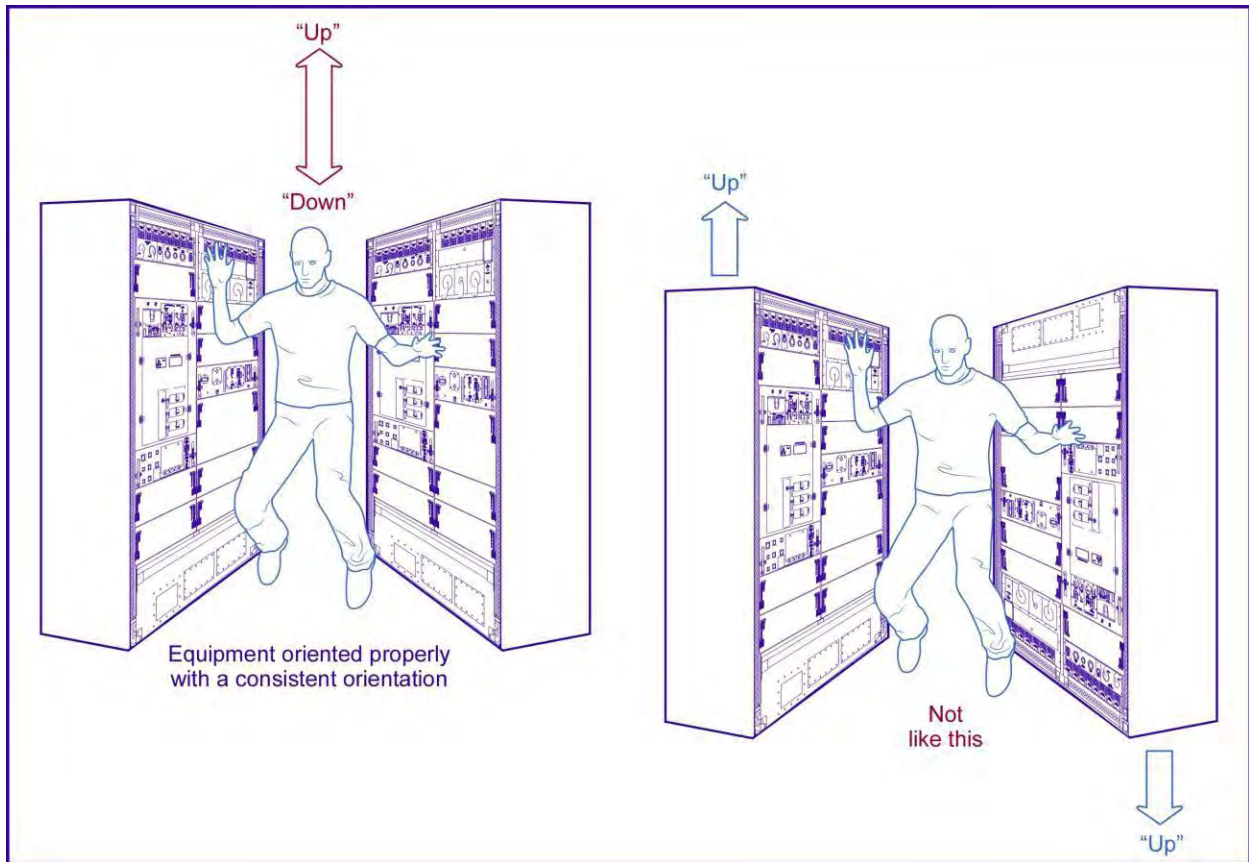


Figure 8.3-4 Consistent orientation for equipment within a workstation or activity center.

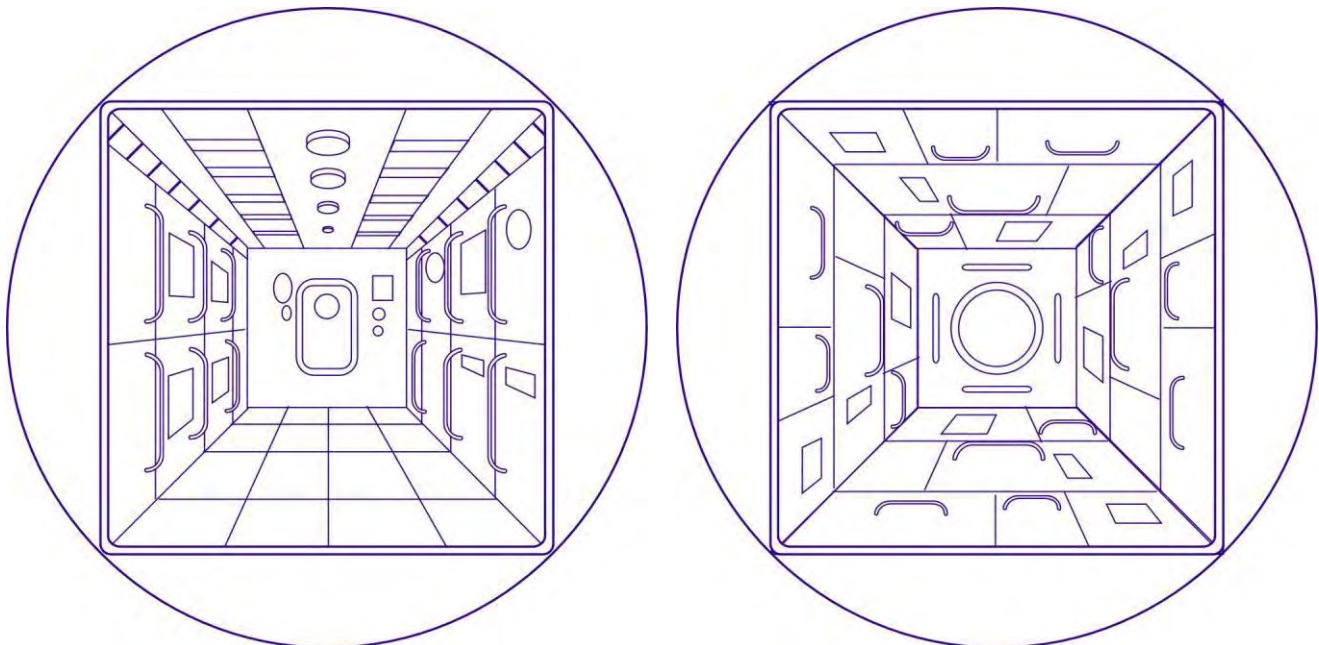


Figure 8.3-5 Left image: Architectural features promote reference planes (up and down) in 0g. Right image: No objects promote a sense of up and down.

In Figure 8.3-5, the image on the left clearly provides a sense of up and down, due to separation and alignment of elements. The image on the right does not provide any clues to what is up and down because no objects have been placed to support such a notion.

One of the modules of Skylab, the Orbital Work Station (OWS), had a consistent local vertical and another module, the Multiple Docking Adapter (MDA), did not. It was found that people adapted more quickly to the orientation of the OWS than they did to the MDA. It also took crewmembers longer to locate a particular storage container in the MDA than in the OWS.

It is important to keep in mind that the buildup of equipment and other stowage during mission operations may hide some reference planes. Designers need to expect worst-case-scenario buildup to create reference planes that can overcome major interior changes.

In addition to overall architectural features, additional orientation aids may be needed to promote orientation and location to increase crew performance, support emergency procedures, avoid hazards, and provide better attention toward areas or tools.

Examples of additional orientation aids include:

- Color and shading
- Labels – labels of systems, modules, directions (starboard, port, nadir, etc.)
- Lights – near exits, tunnels, emergency paths, to define “up”
- Symbols and markings

Most of the additional orientation aids listed above can be considered dynamic and can be rearranged later during mission operations. It is important to incorporate flexibility into these aids.

8.3.2.2 Color and Shading

Color and shading are features recommended to be incorporated into the interior of a module to provide better orientation. Color has been an effective method for orientation and way-finding in the design of the International Space Station. A plan was developed to provide visual cues and routes to escape spacecraft from any location by the application of paint on one interior endcone of the Japanese, European and U.S. modules. Figure 8.3-6 illustrates the endcone paint in the U.S. Destiny Laboratory and the Unity node of the ISS.



Figure 8.3-6 Endcone paint and labels in the ISS modules Destiny (left) and Unity (right). Top: Astronaut Susan J. Helms, Expedition Two flight engineer, works at a laptop computer in the U.S. Laboratory/Destiny module of the ISS (photo no. ISS002-E-5478, 30 March 2001). Bottom: Cosmonaut Mikhail Tyurin, Expedition 14 flight engineer representing Russia’s Federal Space Agency, uses a communication system as he floats in the Unity node of the ISS (photo no. ISS014-E-12521, 21 Jan. 2007).

A combination of lighting and color has also been used to create and promote a “local vertical” in ISS modules. Lighting assemblies provide light from “above” the crewmember’s orientation. To create a sense of “down” or floor, a deep-colored paint was applied to the equipment standoff, giving that architectural feature some “weight.”

Cultural influence has affected color choice and is most evident in the ISS Russian segment. With heritage from the Russian space station *Mir*, the color scheme of the Zvezda Module relates to the Earth with the application of green, tan, and brown – the lighter color helping to reinforce “up” and the deeper color to reinforce “down.”

A 0g environment provides additional work surfaces because orientation and movement are arbitrary in space. Arbitrary orientation in space will require designers to create architectural and additional orientation aids visible from any point in space. Since designers cannot predict the position and orientation of a crewmember at any specific time, it is vital to prevent critical visual cues and aids from being hidden when crewmembers are in certain positions.

In 1g, different spacecraft orientations before launch and after landing will require designers to create orientation and location features that are equally functional with a 90- to 180-degree variation. Orientation and location aids must be provided to support both crewmembers and ground personnel in 1g. Ground personnel may enter the spacecraft before or after flight for configuration, validation, maintenance, or emergencies.

8.3.3 Research Needs

RESERVED

8.4 TRANSLATION PATHS

8.4.1 Introduction

This section provides design guidelines for traffic flow and translation paths, and is applicable to all gravity environments.

8.4.2 General Considerations

Translation paths refer to the physical connections or paths between modules or functional areas.

Spacecraft must have translation paths to support both nominal daily activity and emergency procedures, for both suited and unsuited conditions.

Proper design and implementation of translation paths will provide:

- Increased crew performance
- Optimized logistics and movement
- Traffic congestion avoidance
- Optimized emergency procedures

For each activity it is important to note traffic-flow details such as surrounding activities, number of crewmembers in traffic, frequencies at which crewmembers pass each other, flow velocity, and volume of transported packages.

Traffic-flow diagrams representing flow movements, traffic envelopes, traffic time, and worst-case-scenario flow conditions can help to avoid dead ends and corridors, unnecessary traffic, and collision.

To avoid traffic congestion during worst-case or emergency procedures, less important paths for infrequent operations should be used as alternate pathways or safe pockets, allowing crewmembers to move away from high-priority traffic and activity.

Figure 8.4-1 is an example of a flow diagram used to validate traffic in relation to crew activity.

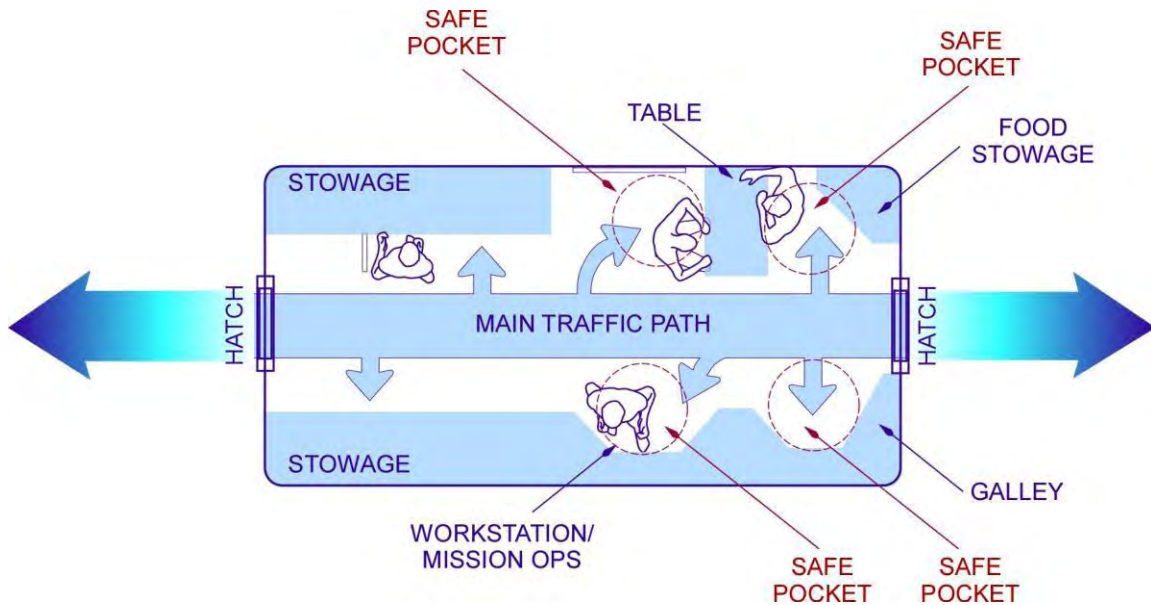


Figure 8.4-1 Traffic flow diagram.

The following factors should be considered when designing translation paths in a spacecraft:

- Type of Translation Path – The required size and shape of the translation path depend on the expected operations in the spacecraft. Design considerations for each type of translation path are given below:
 - Standard Passageway – A standard passageway must accommodate a crewmember in an upright working position or neutral body posture. By definition, the standard passageway need accommodate only a crewmember clothed for intravehicular activity (IVA).
 - Primary Passageway – A primary passageway is the same as a standard passageway but must accommodate an EVA-suited crewmember.
 - Pass-Through – A pass-through (or tunnel) must be large enough to permit passage by a crewmember with his or her long axis in the direction of travel. By definition, the pass-through need accommodate only an IVA-clothed crewmember.
 - Contingency Passageway – A contingency passageway is similar to a pass-through but must accommodate an EVA-suited crewmember.
- Clearances – Translation paths should be located outside the maximum working envelope of the crew station. Stowage, co-location of some activities, and hygiene within the Russian FGB corridor have had an impact on translation on board the ISS.
- Incapacitated Crewmember – Translation paths must allow assisted ingress and egress of an incapacitated suited crewmember. In space, some or all crewmembers may be pressurized, while on Earth, ground personnel may be needed. Transporting injured crewmembers may require large and unexpected traffic envelopes due to limited mobility and flexibility of the crewmember (e.g., in a restrained and recumbent position) and transporting equipment (e.g., litter, restraints).
- Emergency Path Marking – In the event of an emergency, egress paths must be marked and visible under emergency conditions, such as low light and smoke.

- Translation of Packages and Equipment – The translation path must be sized to accommodate the largest crewmember and any packages or equipment to be transported, taking into consideration the package size, the manner in which the package is to be carried, and acceptable clearances.
- Number of Persons Using Translation Path – The translation path must be sized according to traffic considerations. A busy path must be wide enough for two crewmembers to pass each other.
- Orientation of the Body – Turning or rotation required to position the body to translate from one path to another path, module, or door requires an increase in the minimum path size. The minimum dimensions of the path will be defined by the body orientation and method of negotiating the path.
- Gravity – 0g provides increased envelopes for traffic flow and translation paths because crewmembers are able to pass each other at arbitrary angles and levels. Also, rookie crewmembers do not have control of their movement, possibly requiring larger translation paths. Some spacecraft may be used in different gravity environments, such as a lunar lander that is used in both 0g and lunar gravity. In that case, traffic flow must work optimally in both gravity conditions. Designers should consider the “loping” gait that may occur in partial-g, which may require increased traffic envelopes, in both width and height. Conversely, it is possible that lower ceilings may be desirable in partial-g to aid in translation with the hands. The impact on traffic envelopes from walking in partial gravity is not well understood or documented. Translation paths must also be functional in 1g for crew ingress, ground personnel support, and emergency egress.

8.4.3 Restraint and Mobility Aid Location

The following should be considered in determining the location of IVA mobility aids:

- Method of Use – Previous experience has shown that mobility aids such as hand rails are not used for hand-over-hand translation. The longer a crewmember remains in space, the more likely he or she is to use feet for translating and stopping. Mobility aids are used primarily for control of body orientation, speed, and stability. After crewmembers gain confidence in free-flight translation, contact with planned fixed mobility aids is primarily at free-flight terminal points or while changing direction. Padding or kick surfaces should be considered at these points.
- Transport of Packages and Use of Mobility Aids – Consider the packages that crewmembers might be carrying. One or two hands may be required to negotiate and guide the package.
- Suited Crewmember Use – IVA mobility aids may have to be used by suited crewmembers. The location and the size of these aids should accommodate pressurized suits. For example, the clearance between a handle and the adjacent surface should allow a pressurized gloved hand to grasp the handle.
- Substitute Mobility Aids – Surfaces, protrusions, or any handy equipment items may be used as mobility aids. Surfaces and equipment along translation paths should be designed to accommodate this function. This includes ensuring that items that may be used as mobility aids can withstand the force of crew motion on those items.

The following should be considered in determining the location of IVA personnel restraints:

- Operator Stability – Locate restraints where it is critical that a workstation operator remain stable for task performance (e.g., viewing through an eyepiece, operating a keyboard, repairing a circuit). Foot restraints and other ad hoc positioning techniques are insufficient for tasks performed continuously for long periods (i.e., 1 hour of continuous use or longer). Restraining systems should be designed to be stable for the duration of use. Such systems should be stable (i.e., low sway or stagger) and have an intuitive design requiring little to no training to operate.
- Comfort – Restraints that are used for long-durations should be comfortable for the duration of use.
- Counteracting Forces – Restraints should be located where the task causes the body to move in reaction to the forces being exerted. For instance, a crewmember using a wrench needs to be restrained from rotating in the direction opposite to the applied torque.
- Two-Handed Task Performance – Restraints must be provided to allow crewmembers to perform two-handed operations at a workstation in 0g. In other gravity environments, some type of body or foot restraint system should be considered for two-handed operations. Some simple tasks, however, can be easily performed with one hand while using the other hand for stability.
- Restriction of Drift – Not all restraints are necessary for keeping a crewmember at a station. Sometimes a restraint should be used to keep the crewmember from drifting into another area. For example, a relaxing or sleeping crewmember should be restrained from drifting into a traffic, work, or hazardous area.
- Location According to Crewmember Size – The restraint should properly position a crewmember of any size at a station. The restraint should be located so that the smallest and the largest of the defined crewmember population range can perform the task. Restraint adjustment or multiple positions may be necessary.
- Noninterference – The restraint should not interfere with a task. It may be necessary to use a portable restraint and remove it when a station is used for another purpose.
- Functional Areas – Restraints should be considered for locations used for the following functions in the spacecraft:
 - Body waste management
 - Exercise
 - Sleep
 - Meal preparation and eating
 - Handling trash
 - Using the airlock
 - Changing clothes
 - Donning and doffing spacesuits
 - Housekeeping
 - Using workstations
 - Maintenance
 - Medical support

- Payload operations

See section 9.7 for more information about restraints and mobility aids.

8.4.4 Research Needs

RESERVED

8.5 HATCHES AND DOORS

8.5.1 General Considerations

Hatches function as interconnections between spacecraft and modules, while doors separate functional areas in a spacecraft or module.

The following should be considered when locating and designing hatches and doors:

- Type of Hatch or Door and Its Use
 - Pressure Hatches – Pressure hatches should not be too massive or difficult to operate. Because the pressure hatch’s function is critical, operating procedures and hardware should minimize the chance of unsafe operations. Normally, pressure hatch size and controls should be designed to be used by a suited crewmember. Reliability is enhanced if hatch covers open toward the higher-pressure volume, thus making them essentially self-sealing.
 - Emergency Hatches – Emergency hatches are used primarily for escape or rescue. A dedicated emergency hatch should not interfere with normal activities. In an emergency, however, hatch operation should be simple and quick. Where pressure loss is a possibility, emergency hatches should be sized for suited crewmembers.
 - Internal Doors – Internal doors may be necessary for visual privacy, reduction of light, reduction of noise, fire barriers, and restraint of loose equipment. The configuration will vary accordingly.
- Opening Size and Shape of a Hatch or Doorway
 - Size – Each hatch or doorway must be sized to provide access for the largest crewmember. The size of equipment to be carried through a hatch or doorway should be considered (see section 4.3, “Anthropometry”). Certain hatches or doorways may require passage of crewmembers in EVA suits.
 - Suited Crewmembers – All hatches must be large enough for ingress and egress of a suited crewmember. Generally, internal doorways need be used only by IVA crewmembers; in some cases, however, it may be necessary to provide opening room for passage of a suited crewmember.
 - Body Orientation – Frequently-used hatches and doorways must not require body reorientation to pass through. In 0g, this means that the opening should allow passage of a crewmember in the neutral body posture.
- Operations
 - Suited Operation – All opening and closing mechanisms must be operable by a single pressure-suited crewmember.
 - Unlatching – Hatches must require two distinct and sequential operations to unlatch, to prevent inadvertent opening of the hatch.
 - Operation from Both Sides – Hatches must be capable of being opened, closed, latched, and unlatched from either side.

- Rapid Operation – Hatches used to isolate interior areas of the space module must be operable in no more than 60 seconds, including unlatching/opening and closing/latching.
 - Without Tools – Hatches must be operable without the use of tools. Lost or damaged tools will prevent the hatch from being opened or closed, which may result in loss of crew or mission.
 - Pressure Equalization – The ability to manually equalize spacecraft pressure from either side of each hatch, by a pressurized suited crewmember, must be provided.
 - Pressure Measurement – The ability to measure pressure difference across the hatch must be provided from either side of each hatch. This allows both ground personnel and flight crew to see if the pressure difference across a hatch is low enough to safely open the hatch.
 - Windows – Pressure hatches must have a window for direct visual observation of the environment on the opposite side of the hatch, to determine conditions or obstructions for safety purposes.
 - Status – The hatch closure and latch position status must be provided from either side of each hatch
 - Open Position – Hatch covers and doors should be able to remain in the open position.
 - Restraints – Restraints must be provided as necessary to counteract body movement when opening or closing a hatch.
 - Operating Force – The forces required to operate hatch covers must be within the strength range of the weakest of the defined crewmember population (see section 4.7, “Strength”), for the worst-case pressure differential anticipated.
 - Gravity Conditions – Hatch covers and doors must be operable in all gravity conditions and expected orientations to which they are exposed. This may include different body postures, restraints, and opening and closing forces.
- Location
 - Opened doors or hatch covers must not restrict the flow of traffic.
 - To avoid interference with translation, doorways and hatches should not be placed near a translation path juncture (including corners) and should be at least 1.5 m from a corner.
 - Door and hatch covers should not open into congested translation paths. Rather, they should open into a compartment.
 - Door and hatch openings should be sized for the traffic flow. To be efficient, a high-use doorway may require an opening to accommodate more than one crewmember at the same time.
 - Doors and hatches should be positioned such that crewmembers are able to operate any associated mechanisms. Consideration must be given to operator posture and location to ensure adequate clearance for operation.

Alternative designs for doors, such as bi-fold doors and pockets, are recommended if regular doors do not comply with adjacent traffic and activities.

The sketches in Figure 8.5-1 show examples of using these considerations to design the placement of doors and hatch covers opening into a module.

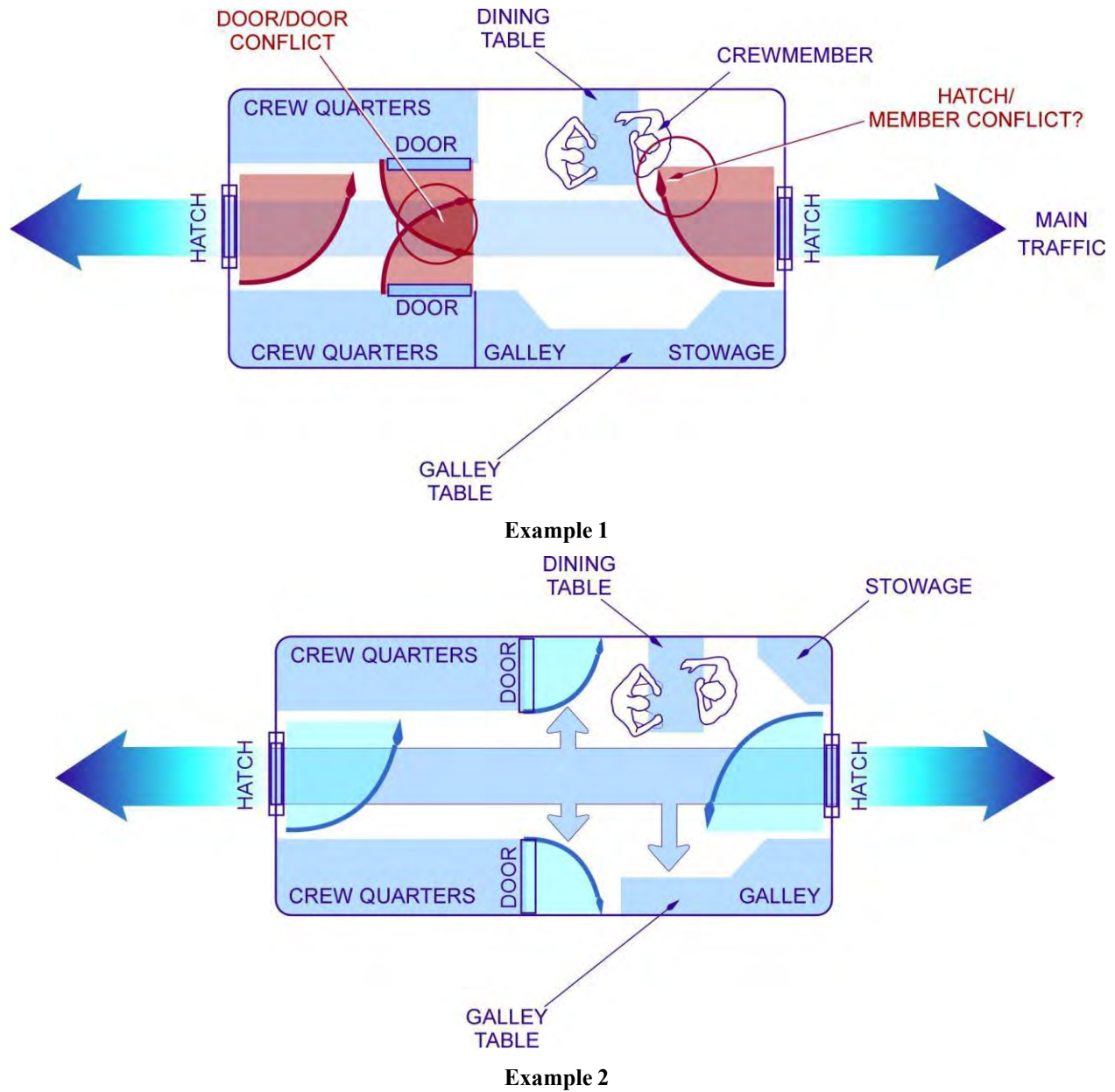


Figure 8.5-1 Initial concepts for hatch and door placement. Example 1: Conflict between crew quarters doors and traffic, and between hatch cover and dining table. Example 2: Reconfiguration of example 1 without door and hatch cover conflicts.

8.5.2 Research Needs

RESERVED

8.6 WINDOWS

8.6.1 Introduction

Human-tended spacecraft including orbiters, capsules, modules, landers, transfer spacecraft, and habitats will contain windows through which the crew will pilot spacecraft, take range measurements using optical ranging devices, observe operations, take photographs, record motion imagery, make scientific observations, and benefit from rest and relaxation near a window. This chapter will present guidelines and specifications for window design and placement in spacecraft. The guidelines apply to all gravity environments (including 0g). Terms and definitions peculiar to the general field of optics are listed in Appendix C of this document, “Optical Terms and Definitions.”

8.6.2 Window Design and Task Support

A window or window port is the first optical element in any optical system (including the human eye) used within the crew cabin of a spacecraft. Successful viewing and imaging through a window depends on the window’s ability to transmit light without distorting the wavefront as it passes through the window. This distortion is known as wavefront error. In an ideal window, a planar wave will pass through it so that the optical path length at each point on the window is the same and the wavefront retains the same phase as it exits the window. Such a window would be said to operate at the Rayleigh Limit, which allows not more than $\frac{1}{4}$ wave peak-to-valley optical path difference, with the reference wavelength typically being 632.8 nm. In an imperfect window, the wavefront is distorted and the phase is not maintained, causing blurring. Wavefront error is aperture dependent, so it affects imaging, photography, and the use of binoculars and telescopes more than it does direct viewing, because the size of even small imaging apertures of 25 mm is relatively large compared to the aperture of the human eye, which is at most 2 mm. This is one of the main reasons a window may seem not to cause any blurring to the naked eye, whereas it is impossible to obtain a focused image through the window (see Appendix C, Sections 1 and 2, “Basic Optical Theory Applied to Windows” and “Optical Design Guidelines for Good Windows”). Even so, windows in past space programs have had wavefront errors and other optical property deficiencies that caused direct eye viewing blurring and distortions (Scott et al., 2003; Runco 1999; Scott, 1996; Heinisch 1971). The optical property requirements and the verification methodologies for them that address these deficiencies are listed in Appendix D, “Optical Performance Requirements for Windows in Human Spaceflight Applications.”

For a window to be used effectively, the demands of the viewing tasks to be performed at the window and the types of instruments (camera lenses, binoculars, telescopes, spectral imagers, optical ranging devices, etc.) to be used with it must first be identified to determine the size of a window port and its prerequisite optical properties. As a window is often used for a variety of tasks that place different demands on it, a window must be able to support the most demanding of those tasks without visual or image degradation. Ultimately, the suite of windows on a spacecraft, that is, the total number and their individual sizes, shapes, locations, and orientations, must support the tasks that mission objectives will require. The tasks for which spacecraft windows are used are delineated below.

- Science – Including astronomy and observations and imaging of orbited planetary and lunar bodies and distant spacecraft. Note: For larger aperture systems such as telescopes, spectral images including infrared systems, and other high-performance imaging systems, the Rayleigh Limit is not sufficient to ensure that noticeable degradation is not introduced by the window. Thus, Category A windows require an optical path difference of no more than $1/10$ wave.
- High-Resolution Photography – Including high-resolution still and high-definition motion imaging of external configuration changes and engineering anomalies, extravehicular activities and events, external inspection, other nearby spacecraft, amateur astronomy, observations and imaging of the Earth (known as crew Earth observations), and for historical and public affairs purposes.
- General Photography and Long-Term Viewing (> 30 minutes) – Including piloting (liftoff, ascent, proximity operations, rendezvous, docking, undocking, landing, navigating by the stars, and driving surface vehicles), robotic operations, and EVA support (IVA view of EVA and worksites).
- Minor Photography and Short-Term Viewing (≤ 30 minutes) – Including viewing through closed hatches for safety and for crew psychological support and recreation (astronomy and observation and imaging of the Earth, planetary and lunar bodies, and other spacecraft).

8.6.2.1 Window Categories

Four window categories are defined below in Table 8.6-1, according to the minimum optical properties that must be met or exceeded to support the activities (tasks) listed for each category. The specific optical properties associated with each category and the verification methodologies for them are provided in Appendix C, sections 1 and 2, respectively. In addition, Appendix D, section 3 contains the verification methodologies for the guidelines contained in this chapter and a glossary of optical definitions, terms, and conventions. Category C windows provide the absolute minimum window size that would allow a single crewmember enough room to view a scene over an appropriate range of angles. Category C windows also provide the absolute minimum optical properties needed to support short-term viewing and minor photography using only small-aperture camera lenses.

Table 8.6-1 Window Category Definitions

Category	Primary Use	Activities Supported
A	Science window ports	Optical instruments, including cameras, binoculars, telescopes, and spectral imagers, using lenses with apertures up to 200 mm in diameter, and all Category B, C, and D tasks.
	Note	For windows that will be used for observations in the ultraviolet and mid- and long-wave infrared wavelengths, additional transmittance specifications will be required to allow passage of these wavelengths. For specialized lasers and optical ranging devices, changes may be required in the transmittance, inclusion, and scratch-dig requirements to make the transmittance greater for the required wavelength(s) and the inclusion class and scratch-dig code more stringent. This would require additional specifications that depend on the particular wavelengths (ultraviolet, laser, and mid- or long-wave infrared) to be used with the specialized window.
B	High-resolution photography window ports	High-definition motion imagery and high-resolution photography with cameras that use lenses with apertures up to 100 mm diameter (generally lenses with focal lengths of 400 mm and greater), and all Category C and D tasks.
C	Piloting, general photography, or large hatch window ports	Piloting tasks, long-term crew viewing to accomplish tasks the crew is performing that normally occur over extended time periods such as rendezvous and robotic operations, psychological support, general photography with cameras that use lenses with apertures less than 50 mm in diameter (generally lenses with focal lengths of less than 180 mm), and all Category D tasks.
D	Minor photography or small hatch window ports	Limited photography with cameras that use lenses with apertures up to 25 mm in diameter (generally lenses with focal lengths of less than 100 mm), psychological support, and short-term crew viewing (to view into a closed module through a hatch door or to view the Earth during exercise with protective covers in place).

Table 8.6-2 further defines the four window categories and provides a summary of the types of instruments and tasks that each category is able to support.

Table 8.6-2 Window Port Category vs. Instrument or Tasks Supported

Window Port Category vs. Instrument or Task Supported	Supported Instrument or Task	Science Window (A)	High-Resolution Photography Window (B)	Piloting, General Photography or Large Hatch Window (C)	Minor Photography or Small Hatch Window (D)
Lenses on visible and near-infrared instruments, telescopes, cameras, and photographic equipment	Up to a 200-mm-diameter aperture (400-mm lens @ f/2.8), spectrometers, & telescopes	√			
	Up to a 100-mm-diameter aperture (400-mm lens @ f/4)	√	√		

Window Port Category vs. Instrument or Task Supported	Supported Instrument or Task	Science Window (A)	High- Resolution Photography Window (B)	Piloting, General Photography or Large Hatch ¹ Window (C)	Minor Photography or Small Hatch ¹ Window (D)
	Up to a 50-mm-diameter aperture (180-mm lens @ f/2.8)	√	√	√	
	Up to a 25-mm-diameter aperture (100-mm lens @ f/4)	√	√	√	√
Visual quality	Piloting and robotic operations	√	√	√	
	Long-term crew viewing ²	√	√	√	
	Short-term crew viewing and psychological support ²	√	√	√	√
Other instruments	High-definition motion imagers	√	√		
	Laser and infrared ranging devices	√ ³	√ ³		

¹ A large hatch is defined as one with a minimum opening size greater than or equal to 122 cm and a small hatch is defined as one with a minimum opening size of less than 122 cm.

² Long-term crew viewing is defined as greater than 30 minutes in duration. Short-term crew viewing is defined as 30 minutes or less in duration.

³ Ranging devices are not usually large-aperture devices and for this reason are generally more sensitive to scatter caused by medium imperfections. Windows intended to support such devices must meet Category A requirements at a minimum as well as any tailored, more stringent transmittance and inclusion class and scratch-dig requirements needed to support the device.

Window categories also have associated clear viewing apertures (CVAs). These minimum window sizes in terms of CVA are the result of numerous human factors cockpit studies and simulations involving crew personnel and more than 50 years of operational spaceflight experience. The minimum apertures are identified so that tasks stated for each window category can be successfully accomplished. Window shape is not restricted as long as it provides the minimum CVA specified.

- Category A windows – minimum circular clear viewing aperture diameter = 50 cm.
- Category B windows – minimum circular clear viewing aperture diameter = 40 cm.
- Category C windows – minimum circular clear viewing aperture diameter = 30 cm.
- Category D windows – minimum circular clear viewing aperture diameter = 20 cm.

Windows intended for a given purpose must be selected by category and must meet all of the optical requirements specified for that category.

8.6.2.2 Minimum Number of Windows

At a minimum, all human-tended spacecraft must have at least two windows excluding hatch windows for external situational awareness, safety, piloting and navigation, spacecraft inspections, observation and photo-documentation of engineering anomalies and scientific and environmental phenomena, crew psychological support, physical health reasons (exposure to natural light for vitamin D production and calcium absorption to prevent bone loss), and for supplementary, alternative, and contingency lighting. In addition, one window must be a Category B window, as spacecraft inspections and photo-documentation of engineering anomalies and scientific and environmental phenomena, astronomy, and planetary (Earth) observation have historically been major crew activities during on- and off-duty hours. Because of their larger size, Category B windows will also allow more natural light into the cabin than any of the other categories of window except Category A windows, with which a given spacecraft may not necessarily be equipped.

8.6.2.3 Multipurpose Windows

Windows used for a variety of tasks must meet or exceed the requirements for the highest category of use except where architectural constraints exist that prevent implementing the clear viewing aperture (CVA) diameter associated with that category, in which case the minimum CVA diameter for the next lower category may be used. For example, a 40-mm CVA window may have Category A optical properties; however, this may present some operational problems and physical limitations with the Category A tasks at the window as a result of the trade-off. This generally forces crewmembers to expend extra time to work around the problems. Lowering the CVA by more than one category would make the higher category tasking at that window either not possible or difficult at best and must not be done. On the other hand, a window with a smaller CVA diameter and less demanding tasking may always have higher category optical properties than its tasking would normally require, e.g., a small hatch window with Category C, B, or A optical properties. Decoupling window categories from their associated CVAs in the opposite direction must be avoided; that is, larger CVA diameters must not have lower category optical properties.

It should be noted that, because of technological advances made in window production, at least where glass is concerned as opposed to other transparent window materials (aluminum oxynitride, sapphire, and diamond among others), higher-category windows are often the more cost-effective option because such windows are the standard, more common production item due to the demand for them over their lower-quality counterparts. This is the result of process improvements in glass production and the use of computer-controlled planetary polishers. Modern production of lower category windows often requires that the higher quality optic be “dumbed” down after it is finished to produce the lower-quality optic. In the past, when such production was manual, the higher-quality optic was more difficult and costly to produce because of the significant amount of extra time and effort it took to achieve the better optic. With automation of the processing, the opposite is now the more common case.

8.6.2.4 Special-Purpose Windows

Windows used for special and unique tasks must meet or exceed minimum requirements by category (usually Category A) plus any tailored optical and physical requirements needed to support the special or unique task. Any normal or multipurpose window may be used as a special-purpose window, provided it meets or exceeds the requirements demanded by both its normal or multipurpose tasking, including CVA size, and its special or unique task without task interference. For example, a Category C piloting window, with a CVA of 30 mm in diameter, or a Category D hatch window, with a CVA of 20 mm in diameter, is upgraded to have Category A optical properties to permit the use of a 200-mm-aperture lens, telescope, or handheld or installed optical ranging device.

8.6.3 Window Location and Orientation

The following should be considered when locating windows in a spacecraft:

- Functional Considerations - Table 8.6-3 lists the considerations that should be taken into account when locating and orienting specific window categories within a spacecraft.

Table 8.6-3 Considerations for the Location and Orientation of Windows within a Spacecraft vs. Window Tasking

Window Task	Location Considerations
Category A Windows¹	
- Spectral and high-resolution imaging for planetary, celestial, and scientific studies and observations (support lens apertures up to 200 mm in diameter)	- Appropriately located and multi-directionally oriented to support these tasks - Near scientific workstations with communications, power, command & data, and imaging & video connectivity and displays - Capability to mount imagers and cameras to a stability of 7.5 microradians - Away from high traffic volume (certain piloting windows/workstations may also be designed for dual use to accommodate these tasks)
Category B Windows²	
- High-definition video and high-resolution photography for imaging of external configuration changes and engineering anomalies, EVAs and events, external inspection, other nearby spacecraft, amateur astronomy, observations and imaging of the Earth (known as crew Earth observations), and for historical and public affairs purposes (support lens apertures up to 100 mm in diameter)	- Appropriately located and multi-directionally oriented to support these tasks - Near interior workstations with communications, power, command & data, and imaging & video connectivity and displays - Capability to mount imagers and cameras to a stability of 25 microradians - Can be located as needed (certain piloting windows/workstations may also be designed for dual use to accommodate these tasks – see also section 8.4)

Category C Windows³

<ul style="list-style-type: none"> - Piloting tasks requiring long-term crew viewing (≥ 30 minutes): liftoff, ascent, proximity operations, rendezvous, docking, undocking, landing, stellar navigation, and surface vehicle driving (support lens apertures up to 50 mm in diameter) 	<ul style="list-style-type: none"> - Appropriately located and multi-directionally oriented to support these tasks - Near spacecraft piloting controls and workstations with communications, power, command & data, and imaging & video connectivity and displays - Capability to mount imagers and cameras to a stability of 50 microradians.
<ul style="list-style-type: none"> - Monitoring and support of EVA personnel, operations and equipment requiring long-term crew viewing - Detailed closeout photography 	<ul style="list-style-type: none"> - Appropriately located and multi-directionally oriented to provide clear, stereoscopic views of EVA operations and worksites - Near interior EVA workstations with communications, power, and imaging & video connectivity and displays - Capability to mount imagers and cameras to a stability of 50 microradians
<ul style="list-style-type: none"> - Operation of robotic equipment requiring long-term crew viewing 	<ul style="list-style-type: none"> - Appropriately located and multi-directionally oriented to provide clear, stereoscopic views of exterior robotic operations and worksites - Near interior robotic control workstations with communications, power, robotic command & data, and imaging & video connectivity and displays - Capability to mount imagers and cameras to a stability of 50 microradians
<ul style="list-style-type: none"> - Through-the-hatch safety viewing - General photography (support lenses with apertures up to 50 mm in diameter) - Monitoring decompression/recompression through large airlock or pressure hatches 	<ul style="list-style-type: none"> - In larger hatches and pressure covers (≥ 100 cm in diameter/across) - In areas where there would not otherwise be a window and structural considerations permit doing so

Category D Windows⁴

<ul style="list-style-type: none"> - Through-the-hatch safety viewing - Minor photography (support lenses with apertures up to 25 mm in diameter) - Monitoring decompression/recompression through small airlock or pressure hatches - Short-term crew viewing (≤ 30 minutes) - Crew psychological support to <ul style="list-style-type: none"> - Provide the critical link to the home planet - Offset the claustrophobic effects of living in confined spaces and long-term isolation - Provide motivational, recreational, educational, scientific, and awe-inspiring experiences - Provide natural illumination and day/night cycles 	<ul style="list-style-type: none"> - In smaller hatches and pressure covers (≤ 100 cm in diameter/across) - In areas where there would not otherwise be a window and structural considerations permit doing so - Near recreational, socialization areas - Near areas of boring, monotonous tasks, e.g., exercise - Near or in private/personnel quarters - To provide views of Earth, planets, moons, and other celestial sights
---	--

1. Category A windows will support the tasks listed for all windows.
2. Category B windows will support the tasks listed for Categories B, C, and D windows.
3. Category C windows will support the tasks listed for Categories C and D windows.
4. Category D windows will support only the tasks listed for Category D windows.

- Traffic – Except for hatch windows, the windows should be located so that use of windows will not interfere with required traffic flow.
- Tasks – The number, size, location, and orientation of windows must provide an optimum field of view to support expected tasks. These include tasks that require crewmembers to be restrained, such as during launch, entry, and orbital maneuvers.
- Lighting and Glare – The following are lighting and glare considerations for window location:
 - Glare – Bright interior illumination will reflect from a window surface and can interfere with the ability to see or take images through the window.
 - Light-sensitive activities – Exterior light entering through windows will interfere with light-sensitive activities such as sleeping, use of monitors or displays, or tasks requiring dark adaptation.
 - Natural light and calcium loss – Calcium loss from bones in 0g is a problem of major concern. Vitamin D, which is produced in the skin when it is exposed to shorter wavelength ultraviolet light (UVB) from sunlight, facilitates the absorption of calcium by the gastrointestinal tract and helps to prevent bone loss. It provides other health benefits as well. Therefore, it is essential that windows be provided in appropriate daily work locations to allow sufficient crew exposure to natural light. It is understood that excessive exposure to UVB radiation can also present dermal and ocular hazards; however, even given the considerations in Chapter 6 for non-ionizing radiation, some exposure to UVB for heliotherapy is acceptable and

recommended within the limitations specified for the UV damage pathway. Windows provided for this purpose should be as widely dispersed around the hull as possible. At a minimum, at least one window excluding hatch windows must be provided for this purpose on all human-tended spacecraft. Two or more are recommended.

- Natural light for illumination – A properly designed and located window can be used as a supplementary, alternative, or contingency source of internal spacecraft illumination.

8.6.3.1 Window Visual Field

The total visual field out the window must be compatible with viewing tasks. The total visual field is illustrated in Figure 8.6-1 and is determined by the following dimensions:

1. Window width
2. Bezel thickness
3. Distance of the viewer from the window
4. Lateral offset

8.6.3.2 Window Vision (Fields of View) for Piloting

The mullions of piloting windows must not subtend an angle greater than 5.0° when viewed from the design eye point for the transition view from one vision area to the next.

8.6.3.2.1 Winged Vehicles

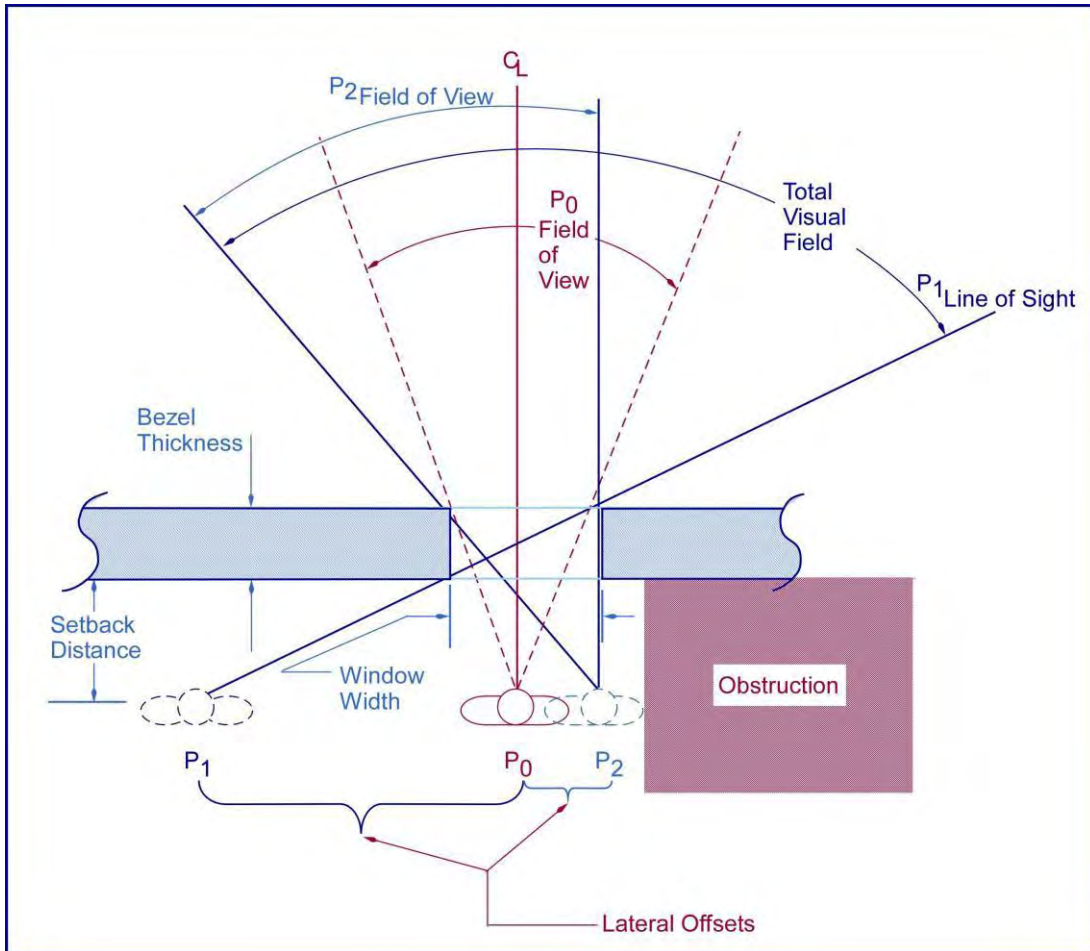
Windows must be arranged by optical quality or category to provide the fields of view specified below for the forward, lateral, and side vision areas. Lower-category windows may have their optical properties upgraded to be commensurate with those of higher window categories without increasing their size. For example, a Category C piloting window with a 30-cm CVA may have the optical properties associated with a Category B window without increasing the CVA to 40 cm. The opposite case is not permitted; that is, a window with a 40-cm CVA (Category B) must not be made with only Category C or D optical properties. More windows providing greater visibility are highly desirable.

8.6.3.2.1.1 The Window Forward Vision Area

The forward vision area must encompass a view looking directly forward along the design eye point (usually the +X axis of the vehicle) to a minimum of 30° abeam on both sides, a 60° viewing area.

8.6.3.2.1.1.1 Forward Vision Area Up-Vision Minimums

There must be sufficient up-vision for the crew to see the normal touchdown point (the first 30% of the runway) plus 2° at the start of a pre-flare maneuver without moving their heads. (The pre-flare point is the transition from the steady-state outer glide slope with its associated high rate of descent to a specified controlled rate of descent from which the landing is accomplished.)



Dimension

Factors Affecting Dimension

Bezel thickness Window category and hardware design
Window width

Setback distance Body dimensions of viewer
Size of workstation console or other equipment around window
Rotation and axis of the line of sight of the observer, instrument, imager or camera

Lateral offset Number of viewers
Obstructions around window area
Viewing requirements of a given task

Figure 8.6-1 Calculation of visual angle from window. Field of view (FOV) and line of sight (LOS) are geometric depictions only. Actual FOV and LOS will be slightly smaller than shown as window edges are unusable (C_L = center line of window).

8.6.3.2.1.1.2 Forward Vision Area Down-Vision Minimums

There must be sufficient down-vision for the crew to see 3° below the horizon at main gear touchdown at the worse-case nose-up attitude (tail scrape angle) without moving their heads.

8.6.3.2.1.1.3 Forward Vision Area Inboard-Vision Minimums

There must be sufficient inboard vision for the crew to see 5° beyond the runway centerline 300 m ahead at the maximum crab angle and a displacement of 10 m left or right of the centerline without moving their heads.

8.6.3.2.1.1.4 Forward Vision Area Outboard-Vision Minimums

There must be sufficient continuous unobstructed outboard vision for the crew to see the edge of the runway and flight ground aids necessary to maintain orientation and angular motion perception at the touchdown point 5 seconds before the touchdown without moving their heads.

8.6.3.2.1.2 The Window Lateral Vision Area

The lateral vision area is defined as the transitional viewing area between the forward vision area and the side vision areas, and it must encompass a view from 30° to 60° abeam on both sides (less the permitted obstruction for mullions, posts, or structure).

8.6.3.2.1.2.1. Lateral Vision Area Up-Vision Minimums

There must be sufficient up-vision for the crew to see a minimum of 10° above the horizon during all banking and turning maneuvers and terminal phase energy management maneuvers without moving their heads.

8.6.3.2.1.2.2 Lateral Vision Area Down-Vision Minimums

There must be sufficient down-vision for the crew to see the sidelines of a 45-meter-wide runway 5 seconds before touchdown and after touchdown, to maintain runway sideline visibility from an abeam position (a minimum of 60° to both sides) to the end of the runway from anywhere within 16 m of either side of the runway at the touchdown attitude without moving their heads.

8.6.3.2.1.3 The Window Side Vision Area

The side vision area must encompass a view 60° outboard from the design eye point (less the permitted obstruction for mullions, posts, or structure) to the aft boundary of the transparency, which must extend a minimum of 10° abaft the beam.

8.6.3.2.1.3.1 Side Vision Area Up-Vision Minimums

There must be sufficient up-vision for the crew to see a minimum of 10° above the horizon during all normal banking and landing maneuvers without moving their heads.

8.6.3.2.1.3.2 Side Vision Area Aft-Vision Minimums

The side vision area aft-vision must be great enough for the crew to verify clear air space during all banking and turning maneuvers without moving their heads.

The side vision area aft-vision must extend a minimum of 10° abaft of the beam.

The side vision area aft-vision must also be great enough for the crew to visually verify the clearance and separation of any wing-mounted detachable pod, module, or other such structure.

8.6.3.2.1.4 Upward Vision

There must also be a minimum of two overhead windows, one Category A window and one Category C window, to provide an upward field of view along a line parallel to the $-Z$ axis of the spacecraft for on-orbit maneuvering. Category size requirements (but not optical quality requirements) may be varied by one category smaller or larger to accommodate structural considerations. A greater number of windows is highly desirable.

The overhead, upward-viewing windows must be mounted so that the planes of these windows are within 10° of being parallel to the X-Y plane of the spacecraft. This number should be minimized so that these windows are mounted as close as possible to being parallel to the X-Y plane.

8.6.3.2.1.5 Rearward Vision

If a cargo compartment or payload bay aft of the crew compartment is provided, there must be a minimum of two aft viewing windows, one category A window and one category C window, to provide a rearward field of view along a line parallel to the $-X$ axis of the spacecraft for observation of the cargo compartment or payload bay and for on-orbit maneuvering and robotic operations. Category size requirements (but not optical quality requirements) may be varied by one category smaller or larger to accommodate structural considerations. A greater number of windows is highly desirable.

The aft, rearward-viewing windows must be mounted so that the planes of these windows are within 10° of being parallel to the Y-Z plane of the spacecraft and provide an unobstructed view into the cargo compartment or payload bay. This number should be minimized as much as possible so that these windows are mounted as close as possible to being parallel to the Y-Z plane.

8.6.3.2.2 Non-Winged Vehicles

A minimum of four windows is required, as follows: two Category C photographic/piloting windows, one port and one starboard, a minimum of 60° circumferentially apart; one Category D general photography/large hatch window; and one conformal category A observation window located to provide outboard visibility on the side of the vehicle opposite to the midpoint between the photographic/piloting windows; or there should be an arrangement of windows to provide the equivalent fields of view and optical quality or category that the above arrangement of four windows provides. Category size requirements (but not optical quality requirements) may be varied by one category smaller or larger to accommodate structural considerations. A greater number of windows is highly desirable.

8.6.3.2.2.1 The Window Forward Vision Area

The forward vision area for the photographic/piloting windows must encompass a view looking directly forward (usually along a line parallel to the $+X$ axis of the spacecraft) from the points where the seated pilots' eyes would normally be located, that is, along a line that passes through the center of the window but set back from the window by some distance equal to or greater than the design eye point, to a minimum of 45° abeam on both sides; however, where feasible the forward vision area must extend to a minimum of 90° abeam on both sides. It is highly desirable

that the forward vision area be provided by a single forward-looking window, but it may be provided by two or more forward-looking windows.

8.6.3.2.2.1.1 Forward Vision Area Up-Vision Minimums

There must be sufficient up-vision for normally seated pilots to see 45° above the X-Y plane of the spacecraft for nonconformal windows and 60° above the X-Y plane of the spacecraft for conformal windows without moving their heads. Conformal windows are preferred over nonconformal windows (see Figures 8.6-2 and 8.6-3).

8.6.3.2.2.1.2 Forward Vision Area Down-Vision Minimums

There must be sufficient down-vision for normally seated pilots to see 20° below the X-Y plane of the spacecraft for nonconformal windows and 25° below the X-Y plane of the spacecraft for conformal windows at a point 3 m ahead of the spacecraft along a line parallel to the spacecraft's X axis with respect to the pilots' normally seated positions without moving their heads. Conformal windows are preferred over nonconformal windows (see Figures 8.6-2 and 8.6-3).

8.6.3.2.2.1.3 Forward Vision Area Inboard-Vision Minimums

There must be sufficient inboard vision so that if two or more windows are used for the forward vision area, the views from the two inboard forward-looking windows (port and starboard) must overlap by no less than 5° at a point 3 m ahead of the spacecraft along the X axis with respect to the pilots' normally seated positions, so that normally seated pilots would not have to move their heads to achieve the view.

8.6.3.2.2.1.4 Forward Vision Area Outboard-Vision Minimums

There must be sufficient continuous unobstructed outboard vision for normally seated pilots to see a minimum of 45° abeam on both sides without moving their heads; however, where feasible, outboard vision for normally seated pilots to see a minimum of 90° abeam on both sides must be provided.

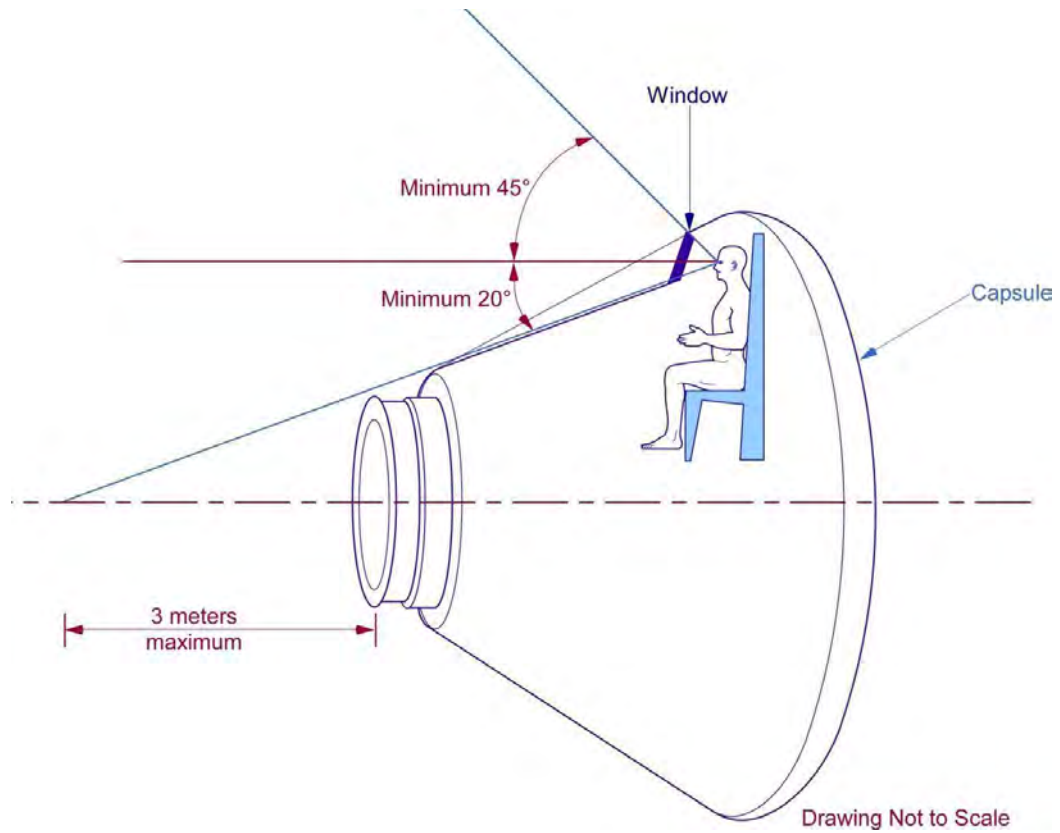


Figure 8.6-2 Forward vision area up- and down-vision for nonconformal windows.

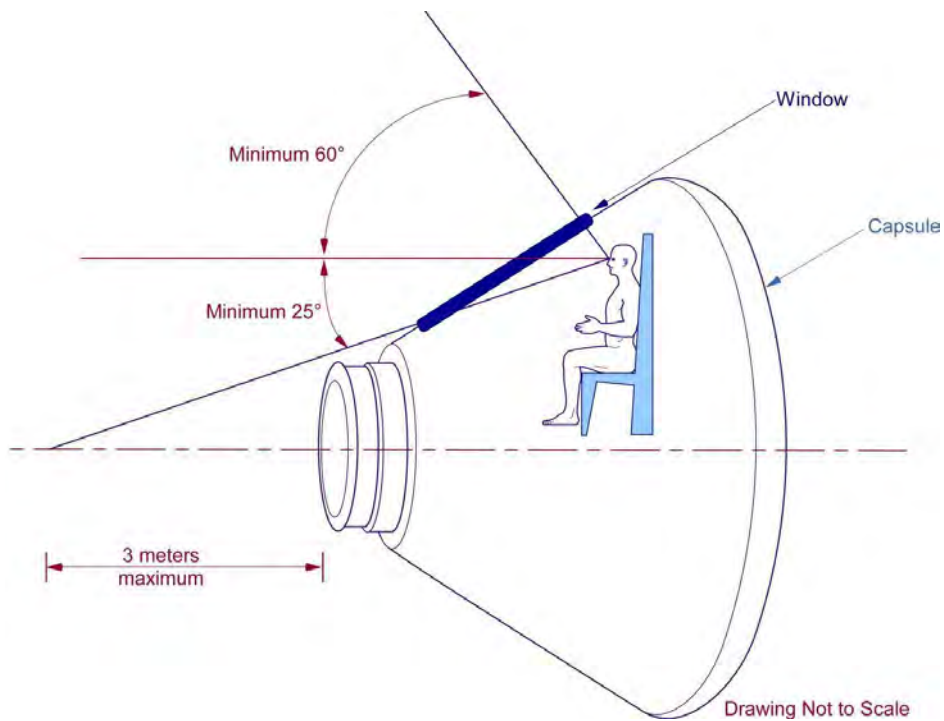


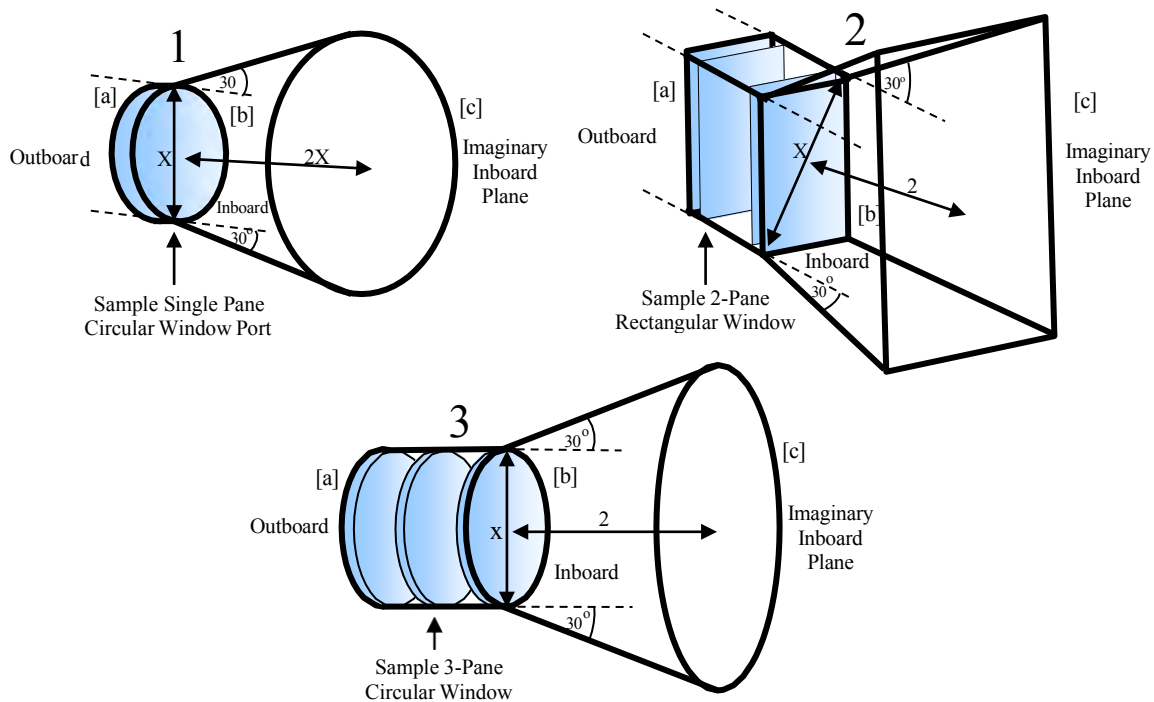
Figure 8.6-3 Forward vision area up- and down-vision for conformal windows.

8.6.3.3 Inboard Window View Obscuration Exclusion Zone

With respect to the spacecraft on which the window is installed, the view through any window must not be obscured or obstructed in any way from within a volume circumscribed by

- The perimeter of the clear viewing area of the outboard-most surface of the window shown as [a] on the sample diagrams in Figure 8.6-4.
- The perimeter of the clear viewing area of the inboard-most surface of the window shown as [b] on the sample diagrams in Figure 8.6-4.
- An imaginary plane located directly inboard from and parallel to the window panes at a distance equal to twice the largest clear viewing area dimension from the inboard-most surface of the window but in no case less than 0.3 m (~1.0 ft) nor more than 1.5 m (~59 in.), shown as [c] on the sample diagrams in Figure 8.6-4.
- The surface that connects [b] and [c] on the sample diagrams in Figure 8.6-4 that slopes 30° radially outward from the inboard-facing normals to [b].

In addition, the interior volume immediately adjacent to and around the inboard-most surface of the window must be sufficient to permit a helmeted crewmember to view through the window or two non-helmeted crewmembers to view through the window simultaneously while their helmet is or their heads are within 1.3 cm (~0.5 in.) of this surface.



Note: The inboard window view obscuration exclusion zone (circumscribed by the bold lines) extends to the outboard-most window surface. Drawings are not to scale and are for illustrative purposes only.

Figure 8.6-4 Inboard window view obscuration exclusion zone.

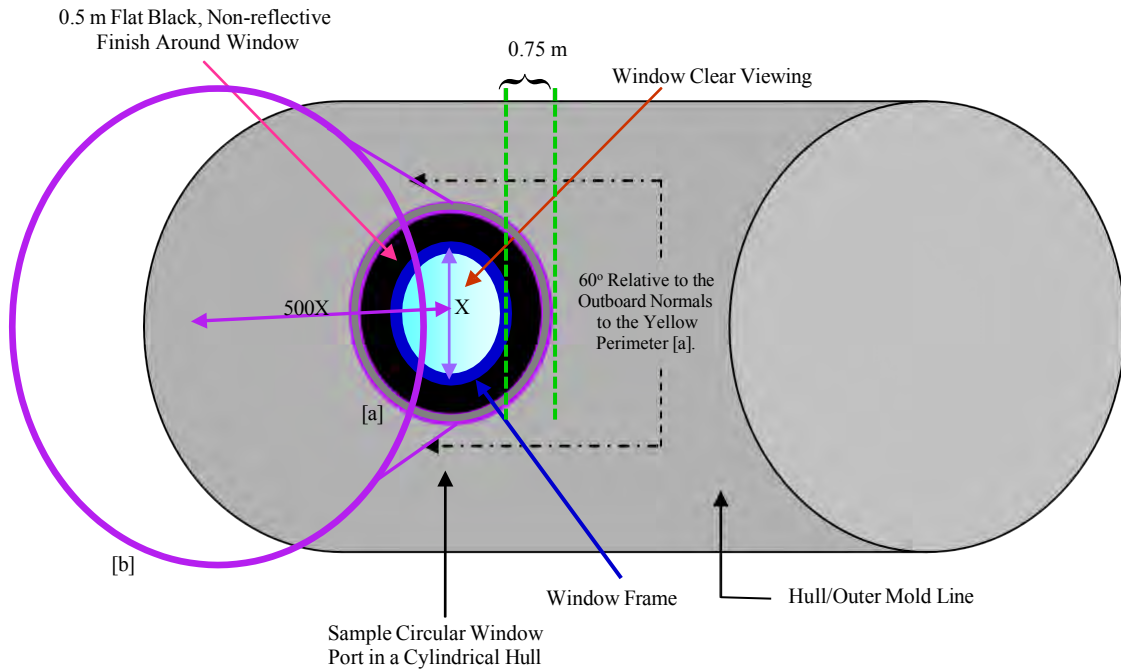
Exceptions to the above obscuration exclusion zones are the following:

- Hardware designed and intended to protect and cover the window when the window is not in use
- Hardware or equipment used in conjunction with piloting such as a head-up display, Crew Optical Alignment System, optical ranging device, or other similar equipment. Any obstruction or obscuration of the view through the window by such hardware or equipment should be minimized
- The inner mold line and hull structure and other windows
- Instrumentation applied to the window itself within 13 mm (~ 0.5 in.) of the perimeter of the clear viewing area
- An analysis is performed with respect to the spacecraft to establish a smaller inboard window obscuration exclusion zone to accommodate specific program and spacecraft requirements

8.6.3.4 Outboard Window View Obscuration Exclusion Zone

The exterior view through any window must not be obscured or obstructed in any way within a volume circumscribed by

- A 0.75-m (~2.5-ft) perimeter around the window on the outer mold line measured from the outer edge (perimeter) of the clear viewing area, shown as [a] in Figure 8.6-5
- An imaginary plane located directly outboard from and parallel to the window panes at a distance equal to 500 times the largest clear viewing area dimension from the outboard-most surface of the window, shown as [b] in Figure 8.6-5
- The surface that connects [a] and [b] above that slopes 60° radially outward from the outboard-facing normals to [a]



Note: The outboard window view obscuration exclusion zone (circumscribed in purple) extends outboard from the outer mold line. Drawing is not to scale and is for illustrative purposes only.

Figure 8.6-5 Outboard window view obscuration exclusion zone.

Exceptions to the above are the following:

- Hardware designed and intended to protect and cover the window when the window is not in use
- Hardware or equipment used in conjunction with piloting, such as a head-up display, Crew Optical Alignment System, or other similar equipment. Any obstruction or obscuration of the view through the window by such hardware or equipment should be minimized.
- The outer mold line and hull structure and other windows
- Instrumentation applied to the window itself within 13 mm (~ 0.5 in.) of the perimeter of the clear viewing area
- An analysis is performed with respect to architecture integration to establish a smaller outboard window obscuration exclusion zone to accommodate specific program and architectural element integration requirements

8.6.3.5 Optical Uniformity

All finished window panes must be optically uniform through the clear viewing aperture (CVA) so that defects do not interfere with tasks planned for use with the window or visually distort or deviate objects viewed through the window at any angle.

8.6.3.6 Window Shape

Window shape is not specified but windows must have the minimum prescribed CVA by category. Circular or round windows are generally less expensive to produce than windows of other shapes and are structurally less prone to stress fractures. If windows of other shapes are required or desired, then any corners or window pane edges must be well-rounded to minimize stress points.

8.6.4 Surface Finish for Window Frame and Surrounding Structure

Stray light, spurious specular reflections and background reflections in the window are significantly reduced when lusterless finishes are used on the window structure itself, on the structure around a window, and on interior surfaces opposite a window. This permits viewing through the window without interference from these unwanted light sources.

The window assembly frame and the supporting structure within 0.15 m (~6 in.) from the perimeter of any window, in all directions around the window both internally and externally, must have a surface finish whose diffuse reflectance is less than 10% over a wavelength range of 400 to 1000 nm and a specular surface reflectance of less than 1% for angles of incidence of 10, 30, and 60° so that stray light is minimized, especially from between the panes. Specular reflectance is defined as the energy reflected into a solid angle having a full angle subtense of 5° (0.006 steradians) centered on the specular angle. The wavelength range is specified into the near infrared because some black finishes are highly reflective in the infrared.

This type of surface finish must be applied both internally and externally to the spacecraft and include fasteners, handrails, and connectors but not labeling, switch panels, switches, and switch guards. These excluded items should have a lusterless surface finish or coating. All finishes and black coatings should be durable so that no special handling is required. Interior surfaces opposite the window should also have a surface finish that meets the diffuse reflectance parameters specified above where possible.

A number of commercially available black coatings, such as Z-306 paint, which has a history of use within NASA, are known to be effective for this purpose. This particular paint has a diffuse reflectance of around 5% across the visible and infrared spectra and a specular reflectance of less than 1%.

8.6.5 Window Surface Contamination

Contamination was a significant problem with the Gemini and Apollo windows, has been seen on Shuttle windows, and is an issue on ISS windows. Seals made from silicone-based materials are particularly unacceptable (Blome, 1967; Leger, 1972; Heinisch, 1971).

In addition, contamination deposition is a line-of-sight phenomenon and falls off at a ratio of $1/r^2$ where r is the distance to the source of contamination. Contamination close to the window is therefore very degrading to its performance and depends on many other factors as well, such as the relative temperature, the type of material outgassing the contaminants, and the presence or absence of ultraviolet radiation. Flight experience and experiments have documented unexpected events that deposited in excess of 10,000 angstroms of outgassed contaminants in a period of days.

Deposition of 200 angstroms of contamination on a window can decrease transmittance by as much as 15%, depending on the composition of the contamination. This amount of transmission loss would negatively affect the use of a window for photography, piloting, and science (Scott et al., 1997).

A non-inclusive list of window problems caused by outgassed contaminants and their associated references follows:

1. On STS-91 small amounts of RTV applied to sharp edges in the payload bay of the Space Shuttle deposited 300 angstroms on the alpha magnetic spectrometer in only a matter of a few days (Albyn, 1999).
2. Witness coupon and TQCM data collected on STS-3, 26, 32, 44, 82, and 91.
3. STS-114 Orbiter DTO #848: Non-Oxide Adhesive Experiment (NOAX) contamination (Koontz, 2005).
4. Certain types of contamination are highly reactive to the Sun's ultraviolet radiation. On exposure to sunlight, any such contamination that is deposited on the surface of the window will photochemically react, polymerize, and molecularly bond to the surface. This bonding renders the contamination permanent. It cannot be cleaned off or otherwise removed, and creates a dark residue on the surface, greatly decreasing optical transmittance. (Scott, 1996).

Appendix D and this document's list of references contain additional documentation concerning molecular contamination.

8.6.5.1 Material Selection and Contamination Prevention for Window Assembly and Installation

Volatiles from material outgassing and offgassing can deposit on and contaminate both accessible and inaccessible (interpane areas) window surfaces, causing a reduction in transmittance over time. This degradation can occur over relatively short periods, on the order of days for some materials. Eliminating such contaminants in the manufacture of the windows and in the areas surrounding the windows will prevent this type of known degradation. Materials used for window assemblies, particularly seals and shutter components, must not degrade transmittance or induce haze by depositing contaminants on the window from material outgassing (vacuum environment) and offgassing (pressurized environment).

To prevent degradation of window performance in the case of outgassing, materials used for window assemblies, particularly seals and shutter components must pass testing per ASTM-E1559 Method B with the additions listed below. This applies to all external materials within 3 m (~10 ft) of any window on the spacecraft as configured for mission use. All materials beyond 3 m distance from the window but within the line of sight of any window on the spacecraft as configured for mission use must be screened per NASA-STD-6016. Materials may be baked out to meet these requirements. Testing may be performed on witness samples. A hardware functionality bench test must be performed to reverify optical performance after baking.

1. One of the three quartz crystal microbalances used in the testing must be at a temperature equal to or less than the coldest temperature the window is expected to attain in its operating environment.
2. The output of the E1559 tests is a condensable outgassing rate for each of the sample and collector temperatures. These rates must be entered into a contamination model, with modifications, that takes into account view factors so that the degradation that the contamination would have on window transmittance is determined.
3. Exposure to UV is required so that the synergistic interaction between solar UV and molecular contamination, which can lead to photochemically enhanced deposition and darkening of the contaminants, is included in the model or determined by test.
4. The model must accurately model materials that are expected to operate in a closed volume (e.g., seals) so that outgassed materials that are constrained by the volume are addressed differently from materials that outgas to space.
5. This requirement is met when the transmittance of all categories of windows is predicted to meet or exceed transmittance and haze requirements after exposure to the outgassed materials.
6. All materials within the line of sight of any window but outside the 3-meter area on the completed spacecraft as configured for mission use must be screened per NASA-STD-6016 using a collected volatile condensable material level of 0.01% that is defined for sensitive surfaces. An evaluation must be performed to determine whether a quartz crystal microbalances temperature colder than 25°C (77°F) is needed, to prevent using materials that would meet the collected volatile condensable material level at 25°C (77°F) but would fail if the actual window temperature was used.
7. Photochemical deposition effects on contamination rate must also be evaluated.

8.6.5.2 Molecular Contamination Removal for Category A, B, and C Windows

A means must be provided to remove molecular contamination of a minimum of 1000 angstroms of uniformly deposited silicone that has not been photopolymerized on Category A, B, and C windows on all spacecraft without marring the surface finish. Exceptions to this can be made for the following cases:

- The spacecraft is a single-use spacecraft that is exposed to terrestrial atmospheric entry.
- The spacecraft is exposed to terrestrial atmospheric entry and has windows categorized as Line Replacement Units (LRUs), and the operational plan is to replace them at some frequency interval.
- It can be shown through analysis that the molecular contamination that would deposit on a window during a mission due to environmental exposure would not degrade transmittance and haze properties below category specifications.

8.6.5.3 Particulate Contamination Removal for All Windows

A means must be provided to remove particulate contamination deposited on all windows on all spacecraft without marring the surface finish. Exceptions to this can be made for the following cases:

- The spacecraft is a single-use spacecraft that is exposed to terrestrial atmospheric entry.
- The spacecraft is exposed to terrestrial atmospheric entry and has windows categorized as LRUs, and the operational plan is to replace them at some frequency interval.
- It can be shown through analysis that the particulate contamination, due to environmental exposure, that would deposit on a window during a mission would not degrade transmittance and haze properties below category specifications.

8.6.5.4 External Contamination Monitoring for Category A, B, and C Windows

A means must be provided to monitor the contamination environment (e.g., quartz crystal micro-balance) for Category A, B, and C windows on all spacecraft where the windows might be exposed to external sources of contamination, so that contamination levels can be monitored and contamination events time-stamped.

Exceptions to this can be made for the following cases:

- The spacecraft is a single-use spacecraft that is exposed to terrestrial atmospheric entry.
- The spacecraft is exposed to terrestrial atmospheric entry and has windows categorized as LRUs, and the operational plan is to replace them at some frequency interval.
- It can be shown through analysis that the particulate contamination that would deposit on a window during a mission due to environmental exposure would not degrade transmittance and haze properties below category specifications

8.6.6 Other Sources of Window Contamination and Damage

In low orbits around planetary and lunar bodies such as in low Earth orbit, windows are subject to many of the hazards detailed in the “Protective Panes and Covers” and “Window Transmittance and Non-Ionizing Radiation” sections of this chapter. Designers must therefore provide the necessary protection for crew and interior equipment based on these expected hazards. Window orientation toward the planetary or lunar body about which a spacecraft is orbiting decreases the flux of micrometeoroids and orbital debris (MMOD) and aids in imaging, mapping, and observation of the orbited body.

On planetary and lunar surfaces dust will be disturbed by EVA activities, and on planetary surfaces spacecraft may be exposed to dust storms, both of which can cause dust to deposit on

spacecraft windows. Angling windows in a slightly downward position may reduce some deposition and may be advantageous for landing but presents limitations to surface observation and photography in the vicinity of the spacecraft along the horizontal. Even so, dust may cling to windows if it is electrostatically charged or has the physical properties that would cause it to do so. The “Protective Panes and Covers” chapter of this document addresses these concerns.

8.6.6.1 Protective Panes and Covers

8.6.6.1.1 External Window Protection

Protection must be provided to prevent natural and induced environmental degradation (e.g., contamination, erosion, and impacts) of the outboard-most window pane.

Exceptions to this requirement can be made for the following cases:

- The spacecraft is a single-use spacecraft that is exposed to terrestrial atmospheric entry.
- The spacecraft is exposed to terrestrial atmospheric entry and has windows categorized as LRUs, and the operational plan is to replace them at some frequency interval.
- It can be shown through analysis that the natural and induced environmental conditions to which the window would be exposed during missions would not degrade transmittance and haze properties below the requirements specified in this document.
- The pane is provided for transparent external protection of the window.

8.6.6.1.1.1 Transparent External Protection

If external protection is in the form of a transparent pane or cover, then

- The transparent external protection must meet or exceed the optical requirements of the category of window for which it is provided.
- The transparent external protection must be removable in less than 1 hour with the use of standard EVA tools by one EVA crewmember and reinstallable in less than 1 hour with the use of standard EVA tools by one EVA crewmember.

8.6.6.1.1.2 Opaque External Protection

If external protection is in the form of an opaque shutter or other operable opaque device, then the shutter or device must be designed so that

- It is manually operable by the crew so that it can be opened within 10 seconds and closed within 10 seconds without the use of tools while the crewmember is located at the window.

- It is remotely operable so that it can be opened within 10 seconds and closed within 10 seconds from a terrestrial ground control center, from another spacecraft on an occupied planetary body, from another orbiting spacecraft, and from onboard locations other than at the window. The times specified do not include signal transmission delay time due to distance.
- It can be removed and replaced in less than 2 hours with the use of standard EVA tools by one EVA crewmember.
- The shutter or device drive mechanism can be removed and replaced in less than 2 hours with the use of standard hand tools by one IVA crewmember.
- The state of the shutter or device, either open or closed, can be determined remotely from a terrestrial ground control center, from another spacecraft on an occupied planetary body, from another orbiting spacecraft, and from onboard locations other than at the window.
- It can be positioned in any intermediate position between fully closed and fully open.
- It can be manually moved in either direction toward open or closed by some means (e.g., using a designated handle or knob, or by handling or backdriving the shutter or device itself) through its entire range of motion by an EVA crewmember. Being able to manipulate shutter or device position from the exterior will allow EVA crewmembers to open or close and position them as required without the assistance of IVA crewmembers. The capability also provides a workaround for an inoperable shutter drive mechanism.
- It provides a light seal when closed such that no external light is observable by an observer with an uncorrected or corrected visual acuity of 20/20 from within the spacecraft when the shutter is closed and the cabin is darkened. This seal may be the same as the particulate/contamination seal.
- It provides a particulate/contamination seal such that, when the seal is closed, no external particulates or contamination can impinge upon or be deposited on the exterior-most surface of the window or on the underside of the shutter or device itself. Molecular contamination or outgassing is a line-of-sight, temperature-dependent phenomenon and flows preferentially from the source of the outgassed contamination to colder surfaces, which windows tend to be when compared to surrounding structures. Outgassed contamination degrades the optical performance of the window. In addition, certain types of contamination including that from thruster exhaust (Fuel-Oxidizer Reaction Product), which is initially mechanically attached to the window and contains highly contaminating hydrocarbons, are reactive to ultraviolet radiation. On exposure to sunlight or any other ultraviolet light source, any such contamination that is deposited on the surface of a window will photochemically react, polymerize, and molecularly bond to its surface. This bonding renders the contamination permanent. It cannot then be cleaned off or otherwise removed, and creates a dark residue on the surface. This now-dark residue decreases transmittance over and above

the decrease caused when it is in its unbonded state. Unbonded outgassed contamination can in certain cases be evaporated away (“baked off”) or will re-outgas over time if environmental conditions allow it. This seal may be the same as the light seal.

- When closed, it protects the exterior surface of the window port and the underside of the shutter or device itself from thruster exhaust plumes, nozzle vents and dumps, and impact damage from MMOD and foreign object debris in the quantities, sizes, and energy levels predicted or derived by analysis for the natural and induced environmental conditions to which the window would be exposed during missions, all of which can degrade or damage the exterior surface of a window and/or its optical performance. Thrusters and dump/vent nozzles must therefore be designed in such a way that they do not impinge on any window nor allow leaks to direct inadvertent discharges toward windows.
- The underside of the shutter or device (the side of the shutter or device that faces the window when the shutter is closed) is never turned outward to face away from the spacecraft so that it is susceptible to particulate/contamination deposition, thruster exhaust plumes, nozzle vents and dumps, or MMOD and foreign object debris (this is the type of shutter used on the SpaceHab module). Alternatively, in the case of a shutter or device whose underside faces outward and is unprotected when it is open (the type of shutter used on the ISS Destiny module’s science window), some form of protection for the underside of the shutter or device must be automatically deployed as the shutter is opened and automatically retracted as the shutter is closed. An example of such a mechanism for this purpose would be the iris in the lens of an automatic camera. Shutters or devices so designed would prevent the re-outgassing and transfer of contaminants from an otherwise exposed shutter surface when it is open to the external surface of a window when it is closed.

8.6.6.1.2 Internal Window Protection

The terms *protective cover*, *protective pane*, *wavefront*, *wavefront error*, *window filter*, and *window shade* used in this subsection and elsewhere in this chapter are defined in Appendix A (Acronyms and Definitions) of this document.

To protect the inboard-most pressure pane of windows from incidental contact, windows must be equipped with internal protective panes or covers.

Exceptions to this can be made for the following cases:

- The spacecraft is a single-use spacecraft that is exposed to terrestrial atmospheric entry.
- The spacecraft is exposed to terrestrial atmospheric entry and has windows categorized as LRUs, and the operational plan is to replace them at some frequency interval.

Otherwise for all spacecraft that do not fall under the above exceptions, the following apply:

- Internal protective panes and covers must be transparent except for any covers that are intended to act as temporary window shades to block external light to darken the cabin interior.
- Each internal protective pane or cover must meet or exceed the optical requirements of the Category of window for which it is provided, except for removable protective panes used on Category A, B, and C windows and removable protective covers used on any window with respect to wavefront.
- Removable internal protective panes must be removable in less than 10 minutes with no more than the use of standard hand tools by one crewmember and reinstallable in less than 10 minutes with no more than the use of standard hand tools by one crewmember.
- Internal protective panes used on Category A, B, and C windows that are removable in less than 10 minutes with no more than the use of standard hand tools and reinstallable in less than 10 minutes with no more than the use of standard hand tools must meet or exceed Category C wavefront requirements.
- Removable internal protective covers must be removable by one crewmember in less than 10 seconds without the use of tools and reinstallable by one crewmember in less than 10 seconds without the use of tools, and operable by one crewmember from fully closed to fully open in less than 10 seconds without the use of tools and operable by one crewmember from fully open to fully closed in less than 10 seconds without the use of tools.
- The peak to valley transmitted wavefront error of removable internal protective covers used on any window that are removable by one crewmember in less than 10 seconds without the use of tools and reinstallable by one crewmember in less than 10 seconds without the use of tools and operable by one crewmember from fully closed to fully open in less than 10 seconds without the use of tools and operable by one crewmember from fully open to fully closed in less than 10 seconds without the use of tools must not exceed 1 wave over any 25-mm (~1 in.)-diameter sub-aperture within the central 80% (minimum) of the physical area of the window where the reference wavelength is 632.8 nm (excluding flight loads, pressure loads, and temperature gradients).
- Internal protective covers may be used to protect internal protective panes.
- Internal protective covers may also serve as window filters.
- An internal protective pane or cover that is not removable or operable within the time periods specified above must meet or exceed the optical requirements of the category of window for which it is provided, including wavefront requirements.

8.6.7 Condensation Prevention

Condensation formation on windows, particularly between panes, interferes with the safe execution of piloting tasks as well as with science, observation, photography, and other viewing tasks. For Category A, B, and C windows except those installed in large hatches, a means to prevent condensation such as an electro-thermal or forced air condensation prevention system (CPS) must be provided to prevent condensation from forming on any window pane surface except the exterior most surface when the window is exposed to:

- The normally expected range of environmental conditions.
- Human breath condensation at a mouth-to-pane distance of 10 cm (metabolic rate = 30 (\pm 5) breaths/minute, single person).
- Interpane venting and pressurization.

For Category C and D hatch windows, a means to prevent condensation such as an electrothermal or forced-air CPS should be provided to prevent condensation from forming on any window-pane surface except the exterior-most surface when the window is exposed to the conditions specified above.

8.6.7.1 Manual Operation of Condensation Prevention Systems

Both electrothermal and forced-air CPSs will degrade optical performance and negatively affect viewing and retrieved still and motion imagery. Condensation prevention systems must therefore be designed so that the crew can turn them off in less than 10 seconds and on in less than 10 seconds while at the window. Being able to turn off such a system temporarily would provide a workaround for the optical degradation caused by the CPS.

8.6.8 Window Transmittance and Non-Ionizing Radiation

For the purposes of ensuring crew safety with respect to hazardous non-ionizing radiation, the transmittance of the window assembly must be evaluated against the limits specified in chapter 6 of this document to determine the amount of attenuation or filtering that is provided by the window at the appropriate wavelengths for each of the four non-ionizing radiation damage pathways of concern. Window filters provided to limit crew exposure to excess levels of non-ionizing radiation must attenuate or filter only to the degree necessary to reduce the effective irradiance of non-ionizing radiation to acceptable levels after any attenuation provided by the window is taken into account.

8.6.8.1 Attenuation and Filtering of Non-ionizing Radiation

Reducing the effective irradiance of hazardous non-ionizing radiation sources may be accomplished through the use of window filters or temporary filters used on any optical instruments that may be used at the window such as lens filters or eyepiece filters. Beam stops or splitters, aperture adjustments, or other appropriate means may also be used in conjunction with optical instruments used at the window to reduce the effective irradiance of hazardous non-ionizing radiation to acceptable levels. Any attenuation or filtering device, or any other means

used in conjunction with optical instruments at the window, must provide sufficient protection to account for any concentration or enhancement of the effective irradiance by the eyepiece of the optical instrument itself. Other ways to reduce the effective irradiance of hazardous non-ionizing radiation sources are:

- Limiting the crew's exposure time and/or cumulative exposure time to hazardous non-ionizing radiation (as appropriate to the damage pathway)
- Having the crewmembers wear protective eyewear such as filtering sunglasses

Window filters provided to attenuate or filter excess non-ionizing radiation at the window must not be permanently attached to it.

Window filters that are provided to attenuate or filter excess non-ionizing radiation and that attach to the window must be removable by one crewmember in less than 10 seconds without the use of tools and reinstallable by one crewmember in less than 10 seconds without the use of tools.

Any means that is provided to attenuate or filter excess non-ionizing radiation and that is attached to the window in any manner should otherwise meet or exceed Category D optical requirements except for wavefront requirements, which instead should not exceed a peak-to-valley transmitted wavefront error of 1 wave over any 25-mm (~1-in.)-diameter sub-aperture within the central 80% (minimum) of the physical area of the window filter where the reference wavelength is 632.8 nm (excluding flight loads, pressure loads, and temperature gradients).

8.6.9 Window Support

The usability of windows is made possible or enhanced by the use of support equipment located adjacent to windows, such as seats, handholds, footholds, restraints, mobility aids, mounts and brackets (for instruments, imagers, and cameras), and electronic connectivity (for communications, power, command, data, and imaging and video equipment and displays). This support equipment must be provided to the fullest extent possible. Other than for electronic connectivity, such support equipment should be temporary and unobtrusive wherever possible and practical. Temporary support equipment must be removable and replaceable by one crewmember in less than 15 seconds without the use of tools.

8.6.9.1 Working Volume Around Windows

The architectural arrangement of equipment near windows should allow adequate volume for the performance of tasks by suitably clothed crewmembers sized from at least the 95th-percentile American man to the 5th-percentile American woman.

8.6.9.2 Electronic Connectivity for Window Support

Connectivity for communications, power, command, data, and imaging and video equipment and displays must be provided within 1.5 m (~5 ft) of all Category A, B, and C windows.

- The capability to mount imagers and cameras to a stability of 7.5 microradians must be provided for Category A windows.

- The capability to mount imagers and cameras to a stability of 25 microradians must be provided for Category B windows.
- The capability to mount imagers and cameras to a stability of 50 microradians must be provided for Category C windows.

8.6.9.3 Window Support in Microgravity

In 0g, crewmembers are able to use all exposed surfaces for stabilization and mobility. Windows should therefore be designed and located so that their exposure to contact by the crew during exercise, translation, or other activities performed in the vicinity of a window is minimized yet still compatible with tasking. In addition, handholds, restraints, and mobility aids must be provided in 0g to allow the crew to orient themselves at windows without contacting or damaging them (see Figure 8.6-6 for a notional depiction of this concept). Any such handholds, restraints, and mobility aids must not obstruct or interfere with the field of view of the windows in any way.

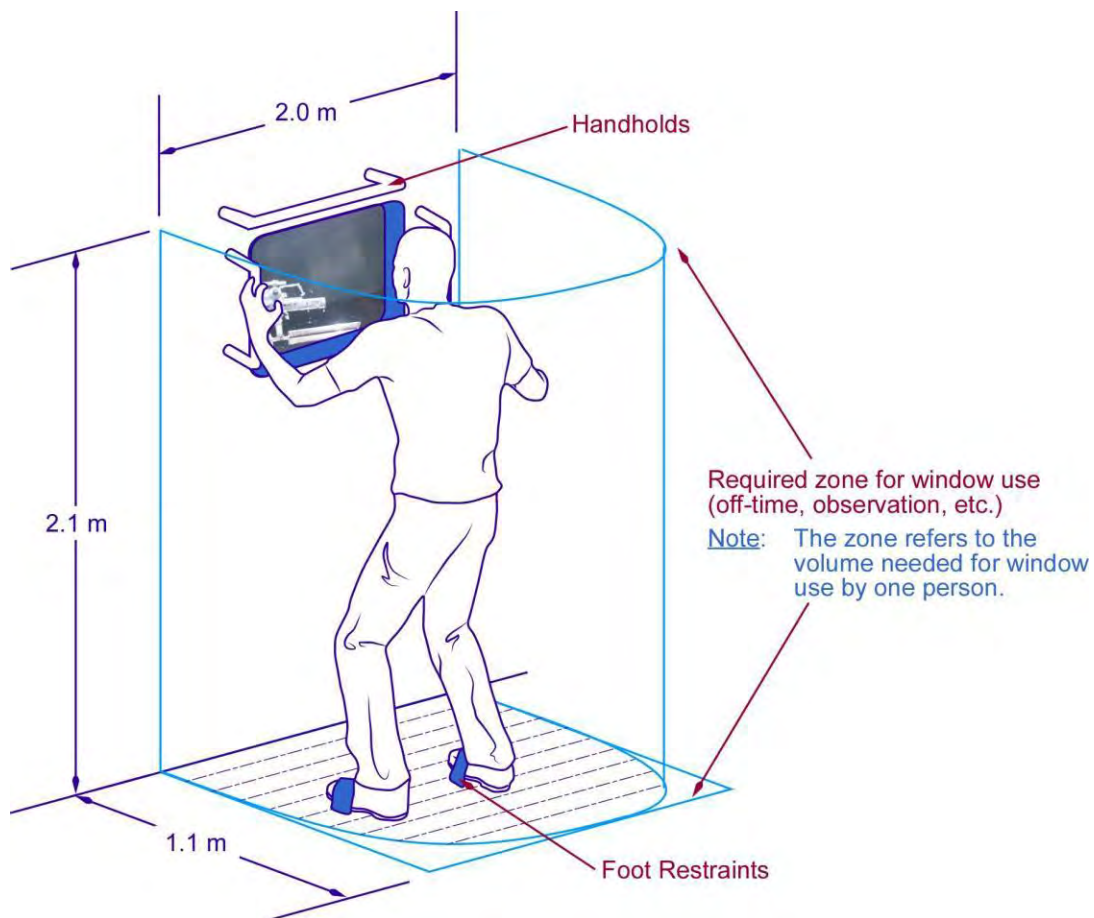


Figure 8.6-6 Window implementation in 0g.

When necessary restraints are not available, crewmembers may make use of nearby hardware not intended for such use, which can lead to damage or failure of the hardware. An example of such damage occurred to the flex-hose jumper on the window assembly in the U.S. Destiny module of the ISS. The final design implementation and location in the ISS internal volume (it looked like

a facsimile of the overhead handholds on subways and buses) facilitated its use by the crew as a handhold so that slight deflections imparted to it over time caused it to develop a crack. The function of the flex-hose jumper was to maintain a vacuum between the primary and redundant pressure panes of the window to eliminate having an additional index of refraction in the light path through the window and to ensure pressure redundancy. The flex-hose did not meet the ISS load requirements for handholds, as it was never intended to be used as a handhold. The crack caused a slow cabin leak overboard. Removal of the jumper stopped the leak; however, the window could not be used, for fear of interpane condensation, until a new flex-hose jumper was made available (the window shutter was kept closed to prevent the window from getting cold and having condensate form in the interpane volume). When the new flex-hose jumper was installed, it was covered by a temporary protection device and made inaccessible to the crew. The interpane volume was subsequently slowly re-evacuated to prevent flash condensation and the window was again made available for use but only after several months had elapsed.

The Window Observational Research Facility (WORF), which was designed to provide the necessary crew support interfaces (handholds, camera brackets, light curtains, etc.), the stable (≤ 19 microradians) platform on which to mount cameras and science instruments, and the connectivity for those instruments (power, data, and cooling), would have also provided the permanent protection for the flex-hose jumper to prevent the incident but was delayed in the manifest. The WORF was later flown and replaced the temporary device. The WORF is an example of an ideal nonpiloting window support device for crew interfaces, cameras, and science payloads (Scott, 1999; Runco, 2003; Runco, 2005).

In 0g, crewmembers assume a neutral body posture so that the body is slightly bent over, creating a sightline angle that is “downward” compared to the normal 1g posture and sightline angle. This change in line of sight due to body posture is important to consider, especially for spacecraft that may be exposed to both 0g and reduced-gravity environments.

8.6.10 Research Needs

Windows can be made from several types of materials. Glass such as fused silica and aluminosilicate, plastics such as polycarbonate and acrylic, sapphire, diamond, and aluminum oxynitride are all viable spacecraft window materials. Each of these materials has its own unique set of optical and structural properties. These properties are somewhat mutually exclusive with respect to spaceflight applications.

Fused silica has been used extensively in human spaceflight applications and is ideal optically because it can be polished to eliminate issues with wavefront error. It is very durable and scratch resistant but not very strong, and must therefore be thicker and most consequentially heavier to meet spacecraft structural requirements.

Aluminosilicate has also been used extensively in spaceflight applications and is very durable. It is stronger than fused silica, especially after tempering, but is not quite as good optically because of wavefront error issues. The tempering process, of course, improves strength, which allows the glass to be somewhat thinner and lighter than fused silica for the same structural requirements, but the tempering process introduces wavefront errors and degrades its optical performance.

Plastics are lightweight, relatively strong, and not brittle like glass. In spaceflight applications durability has been an issue because plastics have low scratch resistance even when they are hard coated. Optical performance of plastics is very poor due to extreme wavefront errors.

Sapphire and diamond windows have excellent optical and structural properties, are very strong, and of course are extremely scratch resistant; however, although process improvements have made them somewhat more affordable, they remain very costly and they cannot be made into the larger sizes necessary for some spaceflight applications.

Aluminum oxynitride is a newer material that holds much promise for use in spacecraft window applications. It is very strong and extremely scratch resistant. It has good optical properties and even though it can be thinner than glass for equivalent structural applications, its weight is on a par with aluminosilicate because of its density. Aluminum oxynitride is used in military applications for windows on armored vehicles and is impervious to 0.50 caliber rounds.

Research in materials processing is therefore needed that would produce a competitive lightweight, optically pure window material for use in human spaceflight applications that is also strong and durable.

8.7 LIGHTING

8.7.1 Introduction

Lighting is important to spacecraft design because visual perception provides the crewmember's primary source of information about the environment. A lighting system can also impact the operation of sensors that are sensitive to light such as cameras, scanners, and sensors that use light as their primary means of operation. Spacecraft lighting systems should be designed to promote efficient crew task performance and well-being as well as meet any requirements for optical imaging within the environment. The lighting engineering process may involve some difficult trade-offs in meeting these needs within power constraints and physical restrictions on light sources and operator placement. These trade-offs must be resolved with consideration for their impact on mission objectives.

This section includes discussion of several important terms and units used to describe lighting, includes discussion of how glare can be minimized, and addresses the process of providing adequate lighting for different tasks, including lighting level and color. This section addresses the design and location of light sources and multiple areas of concern with regard to recommending lighting systems for vehicle architecture. It addresses material selection, light fixture and lamp selection, placement, color, glare, illuminance requirements, and power utilization.

Exposure to hazardous energy sources and eye safety is discussed in HIDH section 6.9, "Non-Ionizing Radiation." Visual capabilities (e.g., visual acuity, depth perception, and color vision) are discussed in section 5.4, "Visual Perception," and lighting for displays is discussed in section 10.6, "Visual Displays."

8.7.2 Lighting Terms and Units

Lighting terms and units are illustrated in Figure 8.7-1. Two sets of units – radiometric and photometric – are commonly used for lighting. Radiometric units are used to describe the

distribution of energy within spectral boundaries without regard to human visual characteristics. Photometric units are used to describe the distribution of energy within the visual spectrum. These units are weighted to reflect the spectral variation of human sensitivity to light.

Radiometric units are typically used when the requirements or definition of the lighting environment are not necessarily human centered (radiometric units have no weighting factor with respect to human vision). Photometric units are typically used when the requirements or definition of the lighting environment are human centered. The two systems are tied together in some cases, such as when the human system impacts the physical system and vice versa.

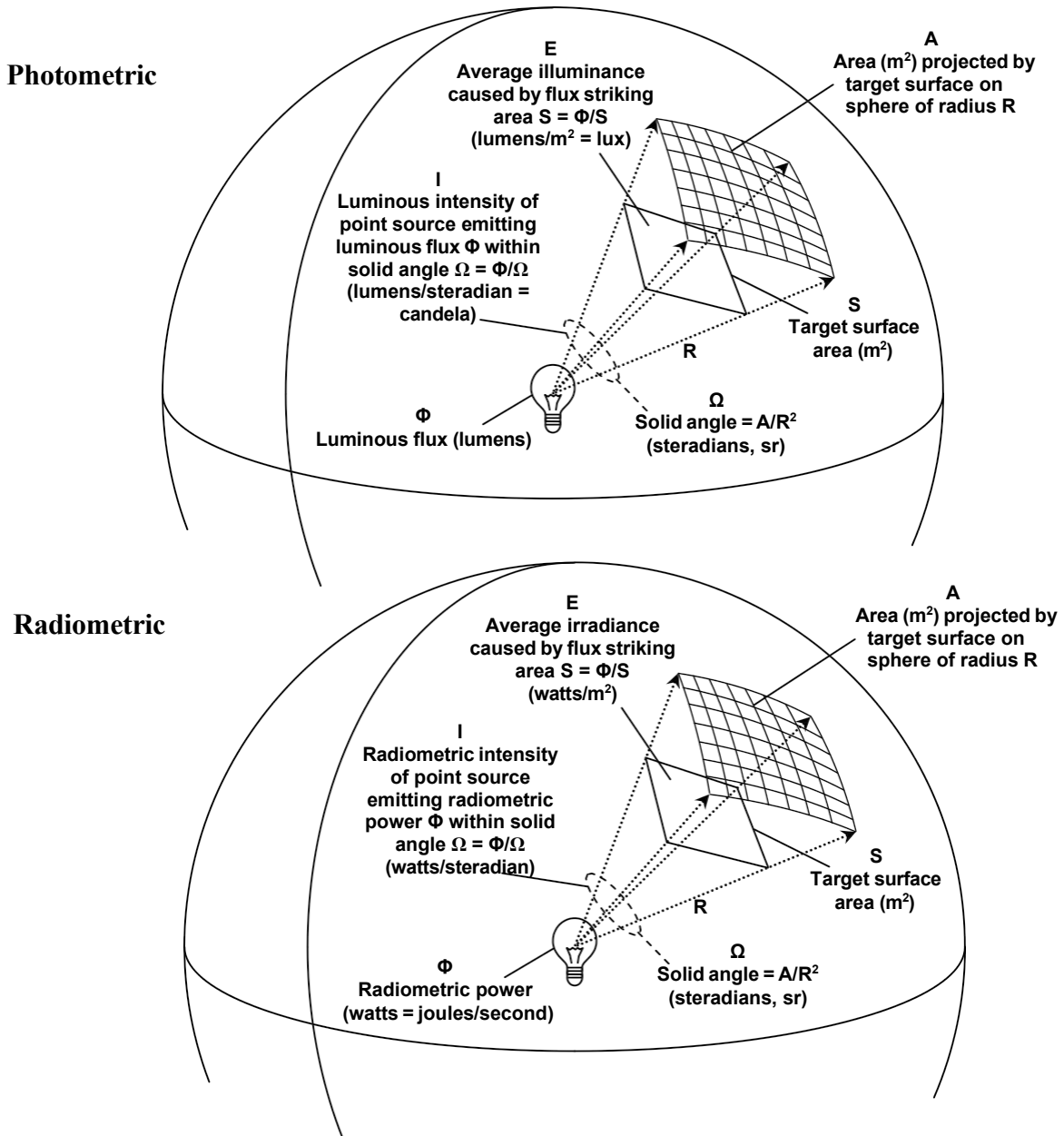


Figure 8.7-1 Lighting terms and units.

8.7.2.1 Radiometric Power and Luminous Flux

The common unit for measuring power in science and engineering is the watt, which describes the rate at which energy is transported or converted from one form to another. Watts (W, joules per second) are used to describe energy flow for radiometric lighting considerations, which are independent of human visual performance. Photons of frequency f have energy (hf), where h is Planck's constant. Radiometric units measure the energy of photons (the power) passing through a region per unit time. Radiometric units allow calculation of the imaging capability of cameras, whose spectral sensitivities generally differ from that of the human eye.

The photometric measurement unit of the lumen is typically used for describing power as it relates to human visual perception. Photometric units reflect the variation of human sensitivity to the lighting power spectrum. In photometric terms, light power at each frequency or wavelength is weighted by an absorption coefficient and summed to give luminous flux.

For humans, the photopic (daylight-adapted) sensitivity to light peaks at a wavelength of 555 nanometers (nm), and at this wavelength the power scales in radiometric (watts) and photometric units (lumens, lm) are related as follows: 1 W = 683 lm (near the output of a 40-W incandescent bulb).

8.7.2.2 Illuminance and Irradiance

When a point source radiates light, it has a power density. This density is apparent when it strikes or passes through a surface. Illuminance and irradiance measurements quantify the density of the light that is incident upon a defined surface area.

In photometric contexts, the distribution of luminous flux over surfaces is measured as illuminance (E), with metric units of lux (lx, lm/m²) or English units of foot-candles (fc, lm/ft²). To convert foot-candles to lux, multiply 10.7 against the foot-candle data. Interior lighting design is usually driven by illuminance requirements for nonspecific "general illumination" and illuminance requirements for specific "task illumination." Illuminance for tasks is usually greater than that needed for general use.

The radiometric unit analogous to photometric illuminance is irradiance (E), watts/m². Irradiance is used to describe the power density at a surface independent of the human visual system's response.

Illuminance and irradiance measurements are important factors when considering a lighting design because they help designers understand the efficiency of the lighting design and whether the design meets task lighting requirements. These measurements also help to quantify why humans and/or machine performance may be improved or degraded within a certain defined lighting environment.

8.7.2.3 Intensity

Figure 8.7-1 illustrates the measure of a solid angle, Ω , in units of steradians (sr), along with the relationships of luminous intensity to illuminance and radiometric intensity to irradiance. Not all light sources emit light equally in all directions. The directionality of a photometric light source is expressed as angular variations in *luminous intensity*, I, in units of candela (cd, lumens per steradian of solid angle). The variation in luminous intensity from a source is often referred to as

the source's beam pattern. For the "point source" case, where the dimensions of the source are very small compared to the distance from it to an illuminated surface, the illuminance on the surface is calculated as the luminous intensity of the source divided by the square of the distance to the surface. This dependency is an example of physics' ubiquitous "inverse square law." This same relationship holds for the analogous *radiometric intensity*, I, in units of watts/steradian and irradiance.

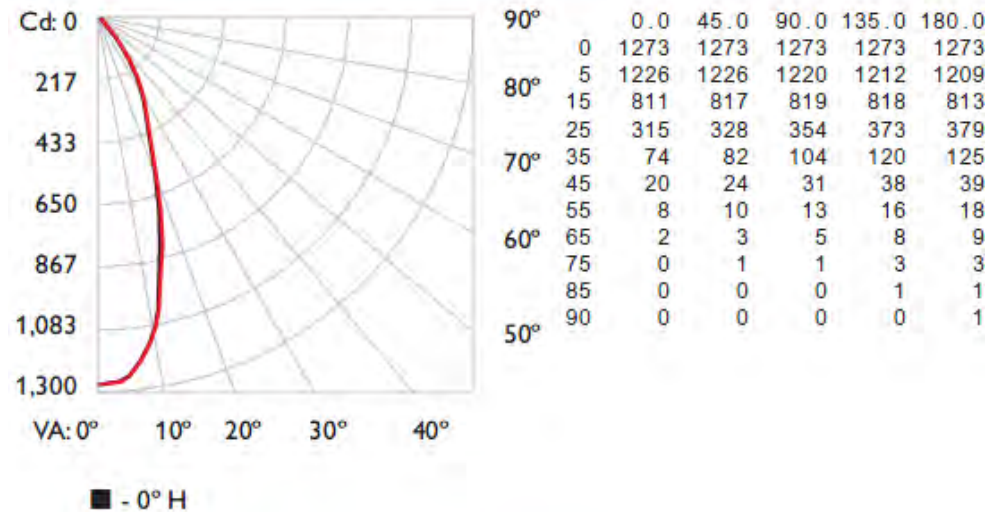
Beam patterns from light sources are important specifications to understand when considering using a specific light source for an application. On a very simple level, the combination of beam pattern data and the distance a work surface is from the light source can be used in conjunction with the inverse square law to estimate the illuminance at a work surface. An example of typical beam pattern data provided by a light fixture manufacturer is shown in Figure 8.7-2. The information is from a datasheet published by Phillips Color Kinetics on their iW Burst Compact Powercore 41 Degree spread lens light source. Reliable light source manufacturers typically provide beam pattern data within the datasheet to assist designers in understanding how far away from the work surface the light source should be located. The figure shows that the light source has a different intensity as the angle changes from the surface normal. Inverse square law calculations must factor in the angle of incidence. The inverse square law formula for calculating Illuminance (E), when provided intensity (I), angle of incidence (Θ), and distance (d) is shown in the following equation.

$$E = (I / d^2) * \cos (\Theta)$$

Photometrics

iW Burst Compact Powercore
41° spread lens

Polar Candela Distribution



Illuminance at Distance

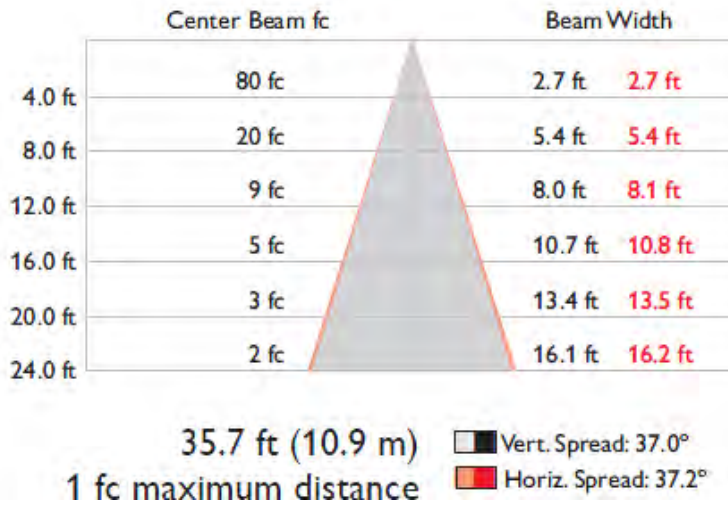


Figure 8.7-2 Light source beam pattern specification from manufacturer datasheet.

8.7.2.4 Photometric Luminance and Radiometric Radiance

Whereas luminous intensity pertains to point sources, another measure, *luminance*, L (not shown in Figure 8.7-1), describes the intensity (luminous flux) per unit area coming in a particular direction from a small area on an extended source or reflective surface. Metric luminance units are $\text{cd}\cdot\text{m}^{-2} = \text{lm}\cdot\text{sr}^{-1}\cdot\text{m}^{-2}$. English units are foot-lamberts (fL), which are defined as $(1/\pi) \text{cd}\cdot\text{ft}^{-2}$.

The perceived brightness of a surface depends on the luminance of (and, thus, retinal illuminance from) that surface. Simply stated, an area of light defined by specific borders appears as a slightly different shape depending on the angle the observer is from that shape. The projected area (A) is defined in the following equation, where length (L) and width (W) define the original shape of the area and (Θ) is the angle in which the observer is situated from the normal of the projecting area. As the angle of the observer approaches 90 degrees from the normal of the surface, the luminance approaches zero.

$$A = (L * W) * \cos(\Theta)$$

Ideally, the light from an elemental area on the surface projects to a retinal area inversely proportional to the square of the distance. However, the amount of light is proportional to the solid angle subtended by the surface element at the eye, and is inversely proportional to the square of the distance. The retinal illumination in lumens per unit area from a surface is independent of the distance and proportional to the surface luminance. *Radiance* is the radiometric analog of luminance, with units of $\text{W}\cdot\text{sr}^{-1}\cdot\text{m}^{-2}$. *Luminance* is an important measurement for determining an object's visibility.

8.7.2.5 Light Interaction with Surface Materials

The materials that surround a light source are part of a lighting system. Materials that interface with light in some manner are important components to a lighting system. Light may reflect off the material, its color may be changed by the material, it may be absorbed by the material, or it may be transmitted through the material. If these features of the surrounding architecture are not captured during spacecraft design, the resulting lighting environment may not be the intended lighting environment.

8.7.2.5.1 Reflectance and Absorption

The relationship between the luminance of a surface and the illuminance on that surface is determined by the *reflectance* of the surface. The reflectance is a dimensionless quantity that describes the proportion of the incident light that is reflected or scattered from the surface. Reflectance is, in general, a function of the wavelength, the angle of incidence, and the angle of exitance (reflectance or scattering). Complete specification of the reflectance of a surface is done via the bidirectional reflectance distribution function, or BRDF, which is measured using a procedure known as gonio-reflectometry.

The component of the reflected light that is reflected in a mirror-like fashion, according to Snell's Law of reflection, is termed the *specular reflectance*. Specular reflections involve just a single interaction of each photon with the reflecting surface. The angular distribution of

specularly reflected light can be broadened if the surface is not flat, as in sunlight reflected by the surface of the ocean when viewed from a great distance. Figure 8.7-3 illustrates an example of specular reflection.

Light that is not reflected specularly undergoes multiple interactions within the surface, generally resulting in a broader distribution of output directions for any given angle of incidence. This is called *diffuse reflectance*. An idealized case (closely approximated by many real surfaces) is that for which the output light intensity varies with the cosine of the angle of exitance, and is independent of the angle of incidence. This relationship is referred to as Lambert's Cosine Law, and surfaces with this property are referred to as Lambertian. Lambertian surfaces have the property that, for a given illumination geometry, their luminance is independent of viewing angle. Most surfaces exhibit a mixture of specular and diffuse reflectance, with additional complications caused by variations in orientation and curvature of localized features. Figure 8.7-3 illustrates an example of specular and diffuse reflection.

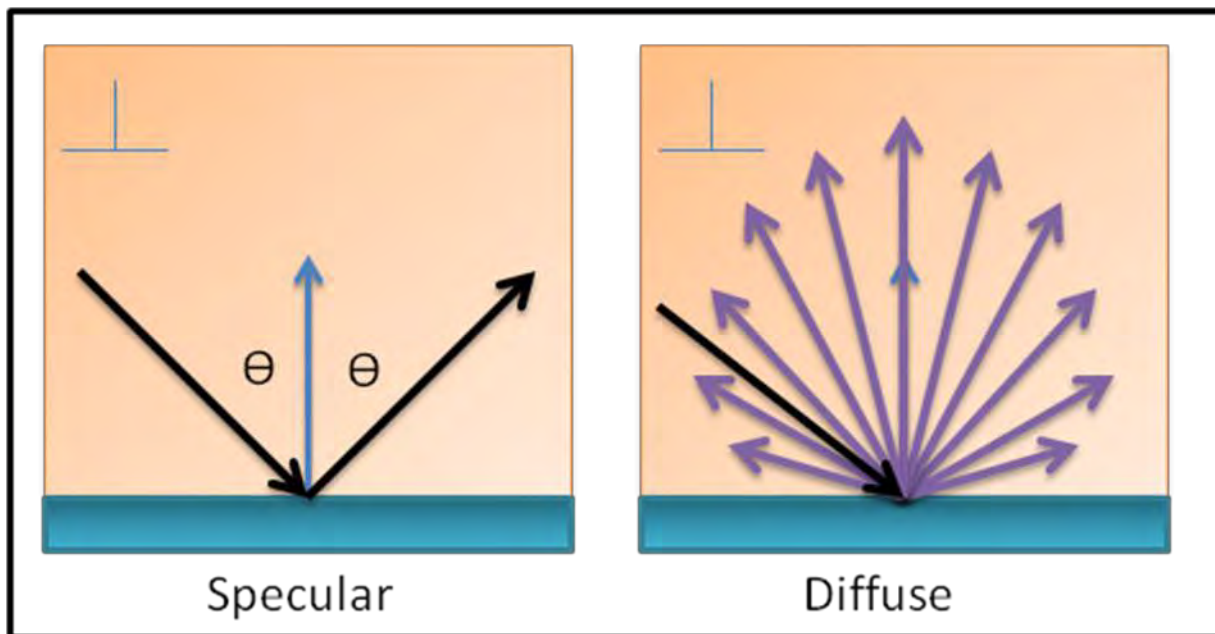


Figure 8.7-3 Illustration of specular and diffuse reflection.

The reflection of light from a material is not necessarily constant at all wavelengths. Different materials may absorb light at a variety of wavelengths with varying intensity. The result is that, often, the reflected light is not the original color of the source. Figures 8.7-4 and 8.7-5 show how a material reflects light, in percent reflectance, at different wavelengths. The intensity of the reflected light can be calculated at the indicated wavelengths by the product of the percent reflectance and the irradiance of the light incident on the surface. The data in the figures were collected using a spectrophotometer, and measurements are shown with (Figure 8.7-4) and without (Figure 8.7-5) ultraviolet light (Lighting Environment Test Facility, Konica Minolta CM-2500 Spectrophotometer). Inclusion of a specular component means that the measurement device included specular and diffuse reflections in its measurement. The measurements show that when an environment departs from the usage of white (or variations of white) surfaces, the resulting color of light in the environment will be different from the source.

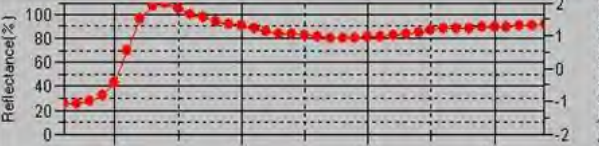

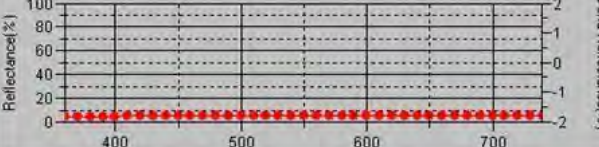


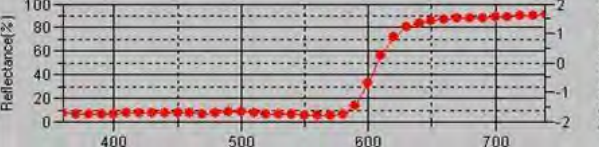








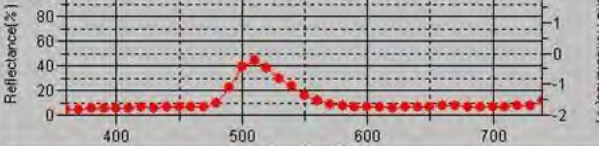


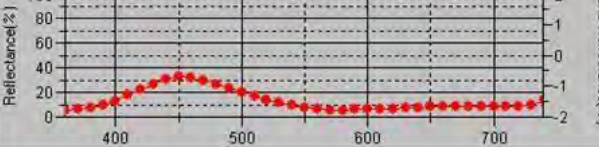


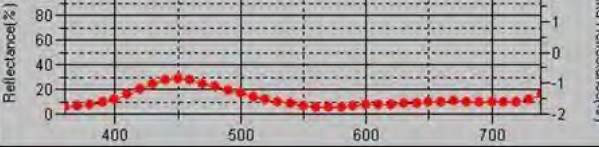
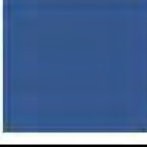
Monitor Color	Programmed R-G-B Value	Spectrum (UV component included) Specular Component Included	Printed Color (Estimate)
	255-255-255		
	0-0-0		
	255-0-0		
	255-153-51		
	255-255-0		
	0-255-0		
	0-0-255		
	102-0-204		

Figure 8.7-4 Example reflectance spectrum (with ultraviolet light).

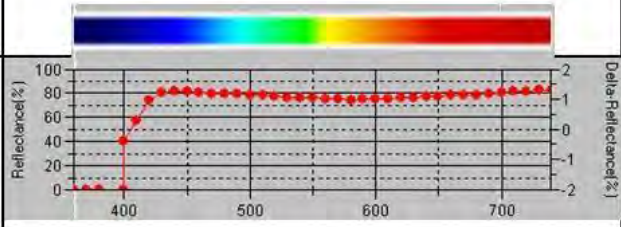

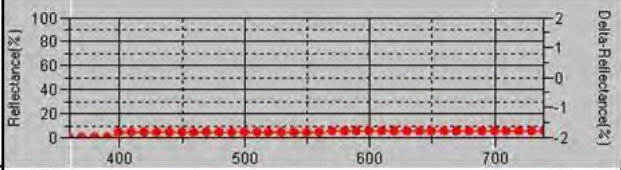

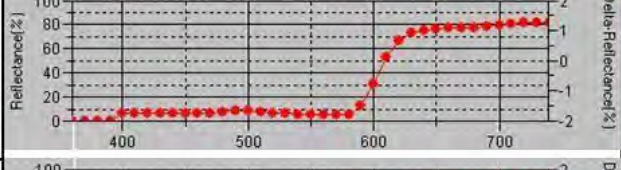

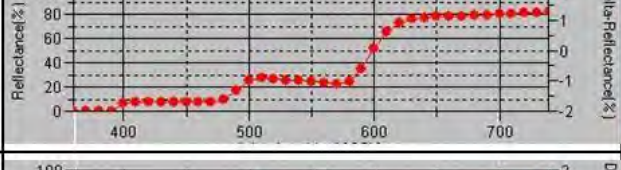

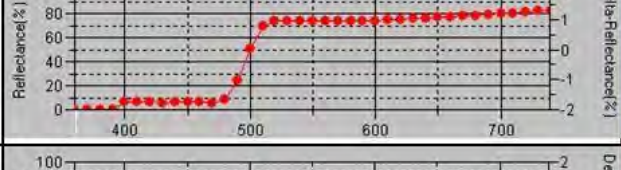

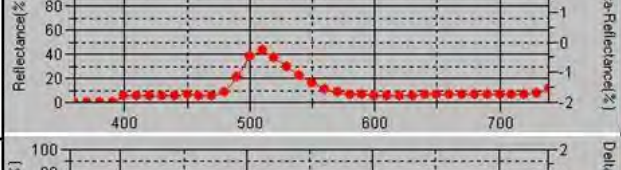
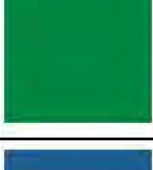
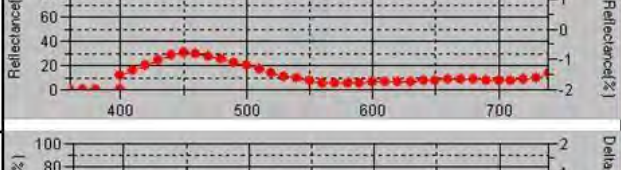

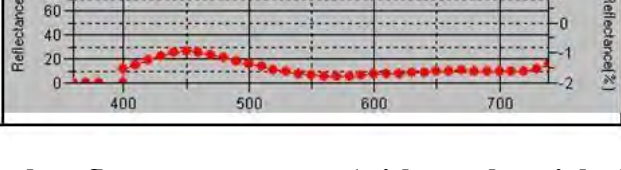

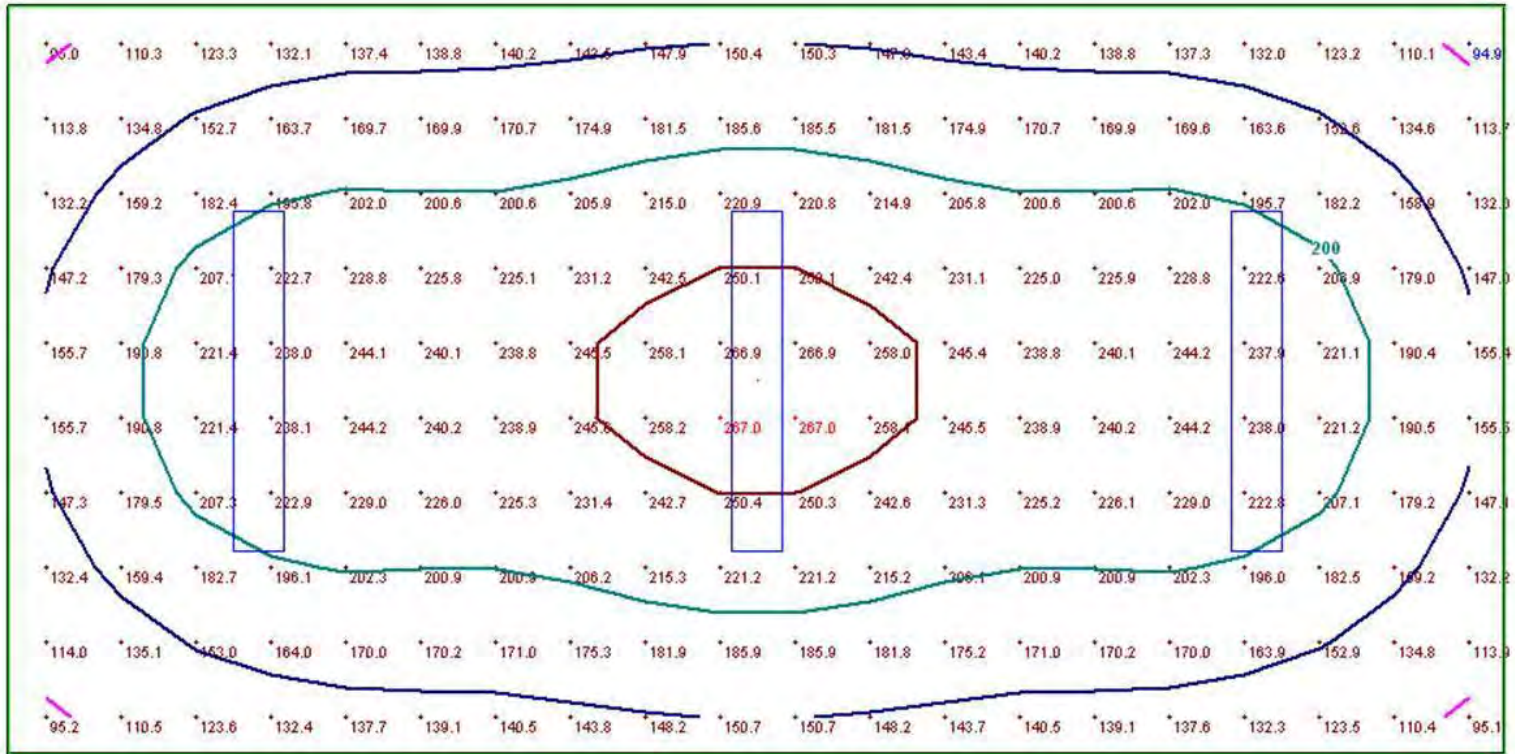
Monitor Color	Programmed R-G-B Value	Spectrum (UV component excluded) Specular Component Included	Printed Color (Estimate)
	255-255-255		
	0-0-0		
	255-0-0		
	255-153-51		
	255-255-0		
	0-255-0		
	0-0-255		
	102-0-204		

Figure 8.7-5 Example reflectance spectrum (without ultraviolet light).

Understanding the material reflectance and absorption properties within a lighting environment is important to be able to characterize the resulting lighting components and for developing a lighting plan that efficiently obtains the intended result. Lighting designers should work with architectural planners to coordinate materials selection. A poor choice in materials can impact the quality of the light at the intended work surface and lead to an unnecessary change in design that requires more light fixtures, and results in increased cost, weight, and power consumption. Figures 8.7-6 and 8.7-7 show a lighting system where the light source remains the same, but the room reflectance is changed (Lighting Environment Test Facility, Johnson Space Center). Figure 8.7-6 has a much smaller area of bright light as opposed to Figure 8.7-7 where the light is more evenly spread across the whole area. Figures 8.7-8 and 8.7-9 show the same room with only two light fixtures (Lighting Environment Test Facility, Johnson Space Center). Note how the illuminance (in lux) at the work surface is impacted. If the designer was designing for an intended illuminance level, he or she may be forced to add more light fixtures to meet lighting requirements. The images for these examples were generated with lighting analysis software using manufacturer photometric files. The method used for performing the calculations was called the Lumen Method. Note that orientation of the light fixture is also important. Light fixture orientation can be used to maximize built-in reflectance features of a room. Because the fixture was surface mounted in these examples, the walls contributed the most to reflecting the light. In summary, if the designer had been targeting an average illuminance of around 200 lux, he or she could have reduced the design to two fixtures in a variety of ways, such as increasing surface reflectance to near 80 percent.

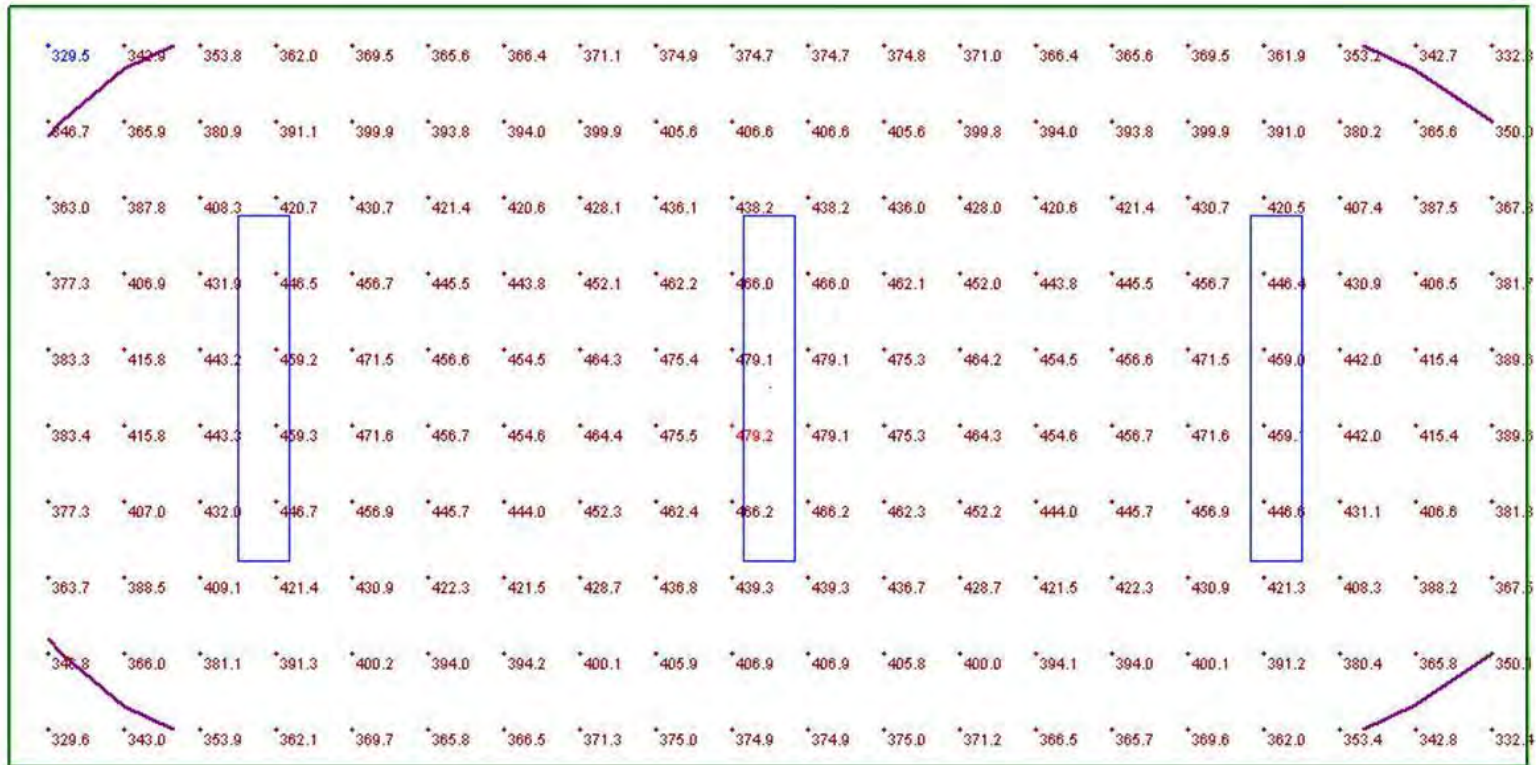


10' wide x 20' long x 9' high room
 Floor Reflectance: 20%
 Wall Reflectance: 20%
 Ceiling Reflectance: 20%

3 Light Fixtures:
 39 LED Symmetrical beam pattern,
 linear surface mount
 VAP_39LED_LYM.ies
 Lamp Lumens: 2974
 Input Power: 39.80 watts each

Total Power: 119.4 Watts

Figure 8.7-6 Reflectance example (three light fixtures, 20% all surfaces).

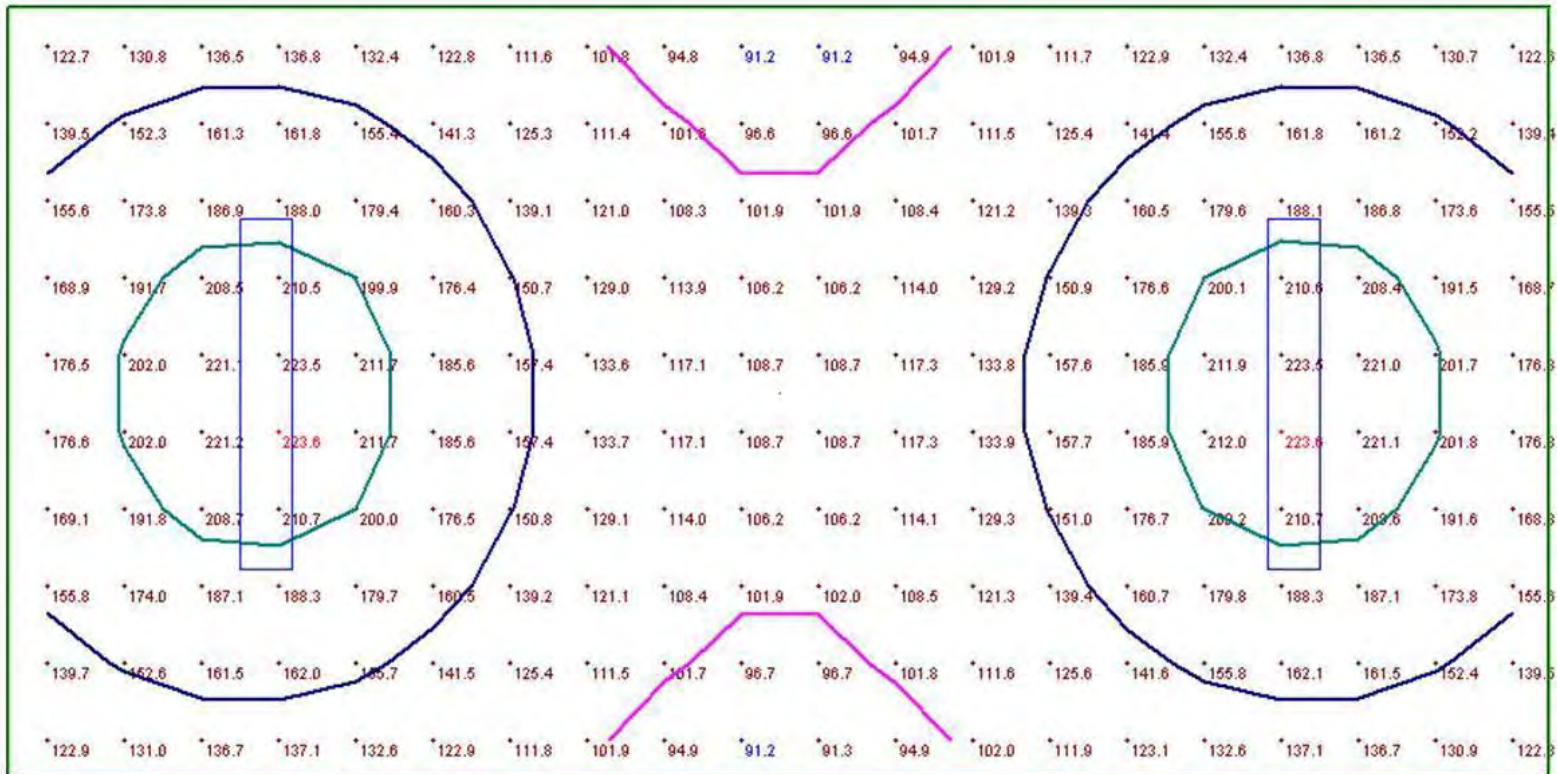


10' wide x 20' long x 9' high room
 Floor Reflectance: 80%
 Wall Reflectance: 80%
 Ceiling Reflectance: 80%

3 Light Fixtures:
 39 LED Symmetrical beam pattern,
 linear surface mount
 VAP_39LED_LYM.ies
 Lamp Lumens: 2974
 Input Power: 39.80 watts each

Total Power: 119.4 Watts

Figure 8.7-7 Reflectance example (three light fixtures, 80% all surfaces).

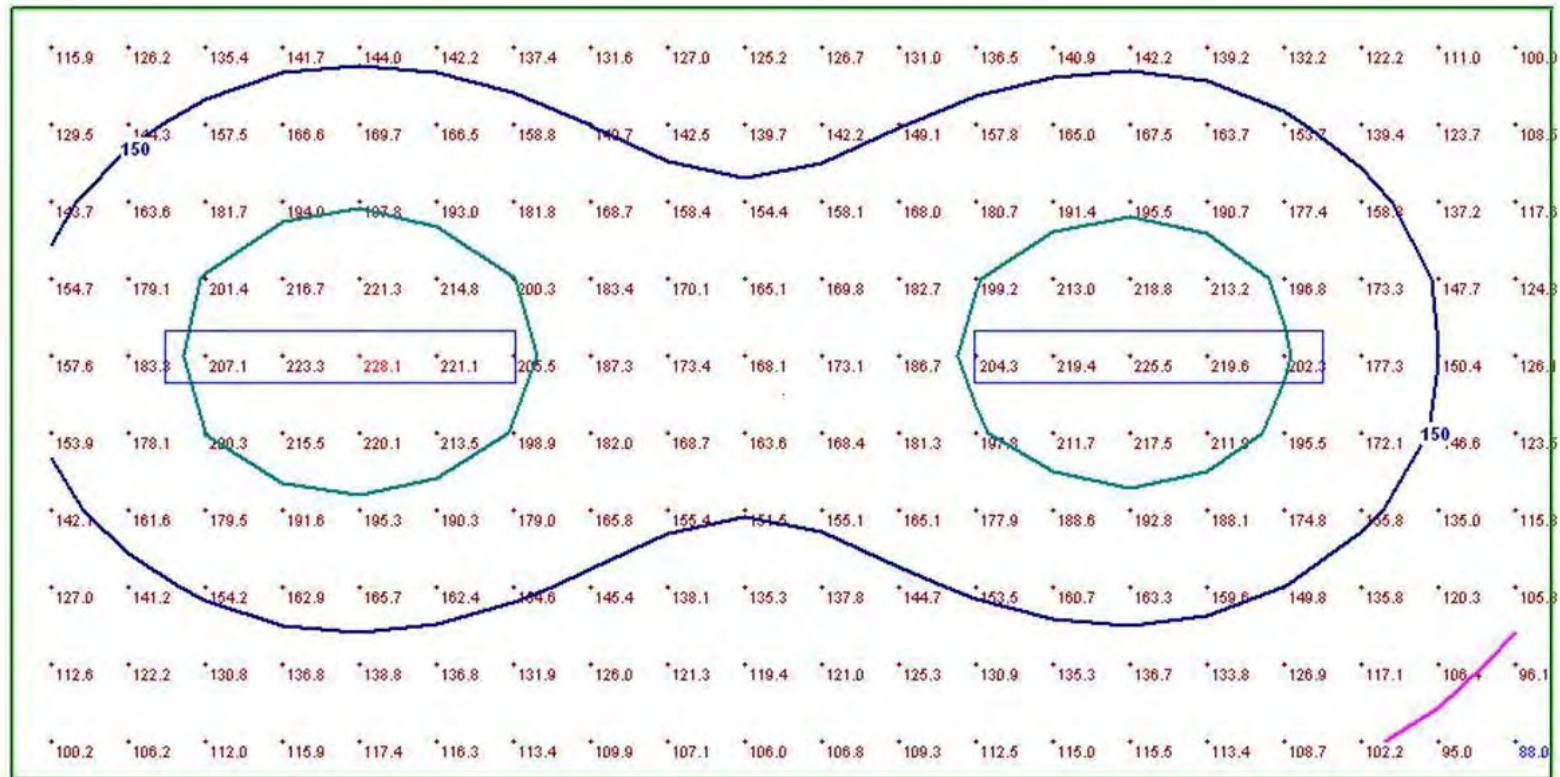


10' wide x 20' long x 9' high room
 Floor Reflectance: 0%
 Wall Reflectance: 80%
 Ceiling Reflectance: 0%

2 Light Fixtures:
 39 LED Symmetrical beam pattern,
 linear surface mount
 VAP_39LED_LYM.ies
 Lamp Lumens: 2974
 Input Power: 39.80 watts each

Total Power: 79.6 Watts

Figure 8.7-8 Reflectance example (two light fixtures).



10' wide x 20' long x 9' high room
 Floor Reflectance: 0%
 Wall Reflectance: 80%
 Ceiling Reflectance: 0%

2 Light Fixtures:
 39 LED Symmetrical beam pattern,
 linear surface mount
 VAP_39LED_LYM.ies
 Lamp Lumens: 2974
 Input Power: 39.80 watts each

Total Power: 79.6 Watts

Figure 8.7-9 Reflectance example (two light fixtures, rotated 90 degrees).

8.7.2.5.2 Transmission

Some materials allow for the passage of light. Many lighting products incorporate the usage of materials surrounding the light source that allow for the transmission of light. Materials that allow for the majority of the light pattern and visual image to transmit are called transparent materials. Examples of transparent materials are sconces. Materials that allow light to pass, but obscure the original image are called translucent. Examples of translucent material are thin white silk fabric and white acrylic panels (diffusers) used to create diffuse light for some light fixtures. Materials that do not allow light to pass are called opaque. Examples of opaque material are metal and wood. Luminous transmittance (τ) is the ratio of total emitted light to total incident light. The intensity of the transmitted light may be calculated given the intensity of the incident light (I_0), and the percent transmittance of the material under test (τ),

$$I = I_0 * \tau$$

The resulting luminous intensity (candela) from a light source traveling through a material is equal to the product of the original luminous intensity (candela) normal to the surface of the material and the percent transmittance with respect to the wavelength of light under evaluation. The coefficient for transmittance is calculated differently depending on whether the substance is a solid, liquid, or gas.

8.7.2.5.3 Refraction

When light enters a transparent material, the light experiences refraction; i.e., light rays are bent. Light is bent because it slows down when trying to pass through a denser medium. Snell's law defines the relationship between incident and refracted light. In the following equation (n) is the refractive index, (i) is the angle of incidence, (r) is the angle of refraction.

$$n_1 * \sin(i) = n_2 * \sin(r)$$

8.7.2.5.4 Contrast

Differences in luminance within a task setting are usually expressed as luminance contrast ratios. These are dimensionless relationships that define the range of luminance over which the user needs to accommodate to perform a task. In uniformly illuminated situations, the luminance contrast between different reflective surfaces corresponds to the ratio of their reflectance. The relationship between the illumination on an object and the available contrast to image the object is extremely complex. In most cases, the luminance contrast among features within a scene is variable and dynamic. The mere presence and motion of the observer affects the distribution of light within the environment, and thus the variation of available contrast.

8.7.3 Glare

Glare must be prevented from causing discomfort and negatively affecting visual performance. Glare is defined as an excessive range of luminance in an observer's field of view (FOV). Glare sources are classified as *direct* or *reflected* (indirect). These are illustrated in Figure 8.7-10.

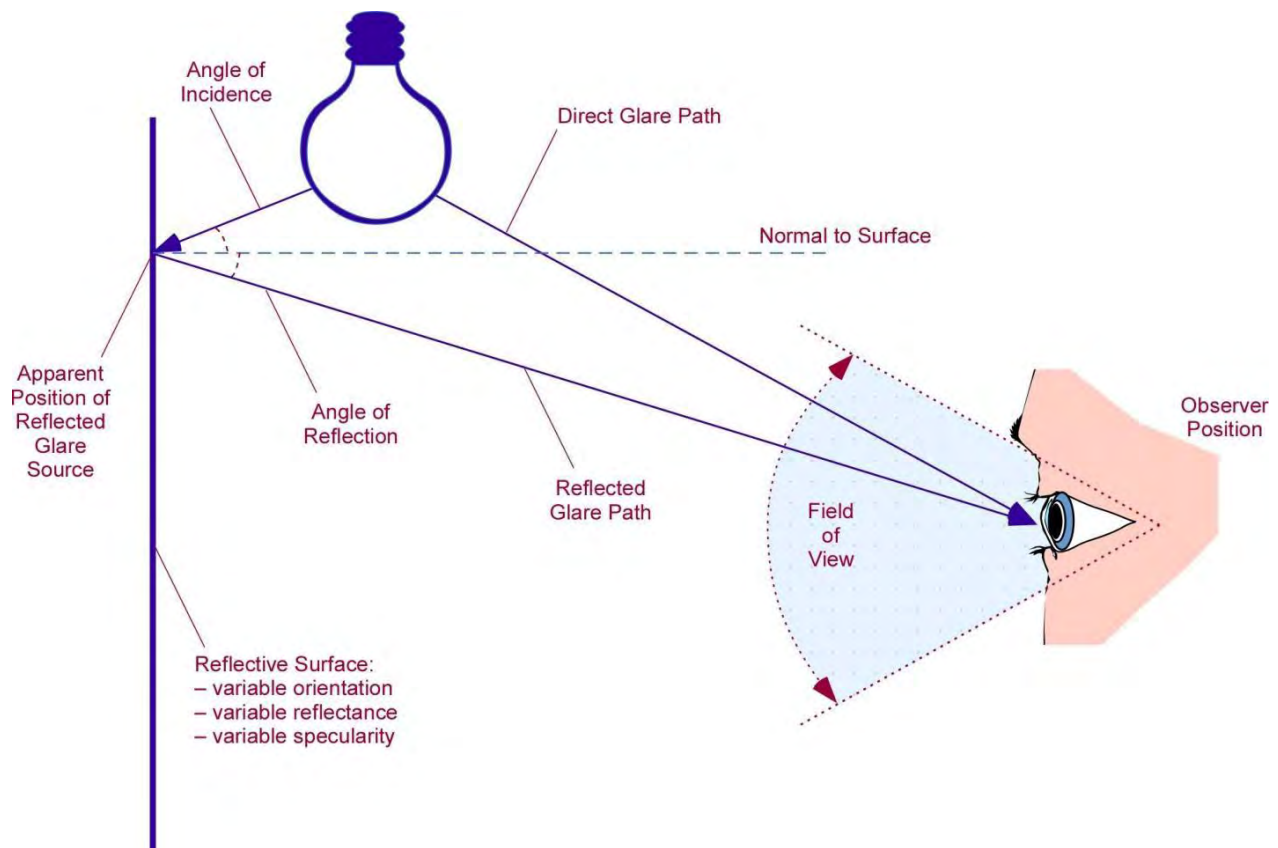


Figure 8.7-10 Lighting glare.

If a light source within the observer's FOV provides much more luminance than its surroundings (higher range of contrast) and occupies a significant portion of the FOV, it may act as a direct glare source. If the reflection of a light source from a surface within the FOV provides an area whose luminance greatly exceeds that of its surroundings, it may act as a reflected (indirect) glare source. The perception of glare is somewhat subjective, and is more likely in older individuals whose eyes contain more optical irregularities to scatter the light entering their pupils. Historically, the age range of flown astronauts is 30-77 years, with an average age of around 42 years.

The potential for glare should be considered when task lighting and general illumination sources have been placed and directed to provide adequate uniform illumination over the areas of interest. Direct ray paths from light sources to anticipated eye points should be evaluated in addition to reflections from specularly reflective surfaces.

8.7.3.1 Factors Affecting Glare Sensation

The physiological or perceptual mechanism for discomfort glare has not been established (Boyce, 2003). Notwithstanding this drawback, five factors that govern the severity of the response to glare have been identified.

- Luminance level – The sensation of glare is increased as the luminance of the source or its reflection is increased.
- Amount of FOV affected – Although luminance does not vary with distance from a source, glare sensation is more likely as the source or reflection occupies more of the observer's FOV, as when the observer moves closer to it.
- Contrast – In cases where the surrounding luminance is much lower than that of the glare source or reflection, resulting in an excessive range of contrast in the field of view, it is possible that increasing the background illumination can reduce glare sensation.
- Location in FOV – Glare sources are less objectionable if they appear in the periphery of the observer's FOV.
- Abrupt changes in lighting levels – These factors may be present within the static lighting environment, or they may be exacerbated by changes from the lighting conditions to which the observer is accommodated, as is the case in suddenly emerging from a movie theater into bright sunshine.

8.7.3.2 Glare Measurement

Several quantitative predictors of discomfort glare in terrestrial rooms have been developed over the last 50 years. Perhaps the best known are the discomfort glare rating system and the related visual comfort probability, or the unified glare rating (UGR) adopted by the Commission Internationale de L'Éclairage (CIE). The UGR formula and application guidelines are provided in the CIE standard titled *Discomfort Glare in Interior Lighting* (CIE, 1995b). The capability of the UGR to predict subjective glare response, however, has been shown to be limited (Boyce, 2003). The extensive use of the UGR or any other glare index in designing for extraterrestrial accommodations is probably not productive, since architectural constraints for these spaces likely violate significant assumptions underlying such indices. At best, they might be marginally useful in considering alternative designs.

Mock-up evaluations are probably the best resource for glare suppression guidance in design. Preventive measures and good practices exist, and should be considered in designing lighting systems for working environments that are different from those addressed in terrestrial lighting design guides. Interior light sources in spacecraft may be impossible to position or shade to absolutely preclude direct glare. The interior volume of the spacecraft is typically small compared with terrestrial living spaces, and so it is likely that light sources mounted within it will fall within an inhabitant's FOV for some working locations within the volume. The possibility of direct glare can be further increased by the lack of gravitational forces to promote adoption of a preferred orientation relative to the light sources within a habitable space. In 0g, a spacefarer may float in any position.

8.7.3.3 Glare Control

Table 8.7-1 recommends ways to avoid glare. For considerations on extravehicular activity (EVA) suit visors, see section 11.3.12.2 “Effects of EVA Helmets on Lighting.”

Table 8.7-1 Glare Control

Source	Control	Remarks
Direct (windows or lamps)	Reposition outside FOV	
	Shade	
	Indirect lighting	If a common, diffuse, highly reflective surface is used to reflect light from the indirect illumination sources, the illuminated surface may provide a natural orientation cue in the manner of a terrestrial sky or ceiling.
	Diffuser to divide and redirect the beam pattern emitted by the source	The diffuser refracts bundles of rays from many discrete areas on its surface in different directions. This replaces a single high-luminance source, occupying a relatively large solid angle, with an array of many sources having similar luminance, but occupying much smaller solid angles for the observer.
	Sunglasses	Sunglasses will also reduce contrast ratios within the environment. This reduction in available contrast may impair visual performance while reading printed matter and displays, and it may impair the legibility of self-illuminated control panel legends. Light polarization is used in liquid crystal displays (LCDs) to produce variations in contrast across their indicating surfaces. Polarized sunglasses may effectively obscure an LCD to varying degrees as an observer’s head is rotated with respect to the display.
Reflected	Reposition outside FOV	
	Avoid glossy surfaces	
	Orient surface to avoid glare	Specular surfaces are most likely to be troublesome if they are planar or concave. Concave specular surfaces may gather light from multiple sources and focus it at a viewing point, and so these should be avoided. Convex surfaces may prove far less critical, since they disperse the incident light rays. A large light source reflected in a convex surface appears as a smaller, less-luminous line or point source.

Verifiable workstation glare requirements are usually written in terms of maximum allowable surface luminance ratios measured in the environment where the task is performed. These luminance ratios are summarized in Table 8.7-2. The exterior case, which applies to EVA operations, is limited to requirements for only the immediate work area, since the surrounding lighting environment is expected to be dynamic and poorly controlled. Among the surfaces involved in a task, luminance ratios must be limited to 5:1 (Nicogossian, 1994).

Table 8.7-2 Luminance Ratios for Workstations

Luminance Ratio Comparison	Workstation Location	
	Interior	Exterior
Between tasks and adjacent surroundings	3 to 1	5 to 1
Between tasks and more remote surfaces	10 to 1	N/A
Between light sources and adjacent surfaces	20 to 1	N/A
Between immediate work area and surfaces in the rest of FOV	40 to 1	N/A

From IESNA, 2000.

8.7.4 Lamps and Lighting Fixtures

The lighting industry has developed a wide array of lighting solutions since the invention of the Edison lamp. When determining a solution for a lighting problem, the designer should consider the advantages and disadvantages of various lighting technologies before selecting a lamp or fixture type as a solution. The application of a lighting technology for space travel adds additional complexity to lamp and fixture selection because some of the environmental advantages lighting architects have on the ground (e.g., gravity, convection, atmosphere at standard air pressure) are not available for space vehicles.

8.7.4.1 Beam Pattern

A beam pattern is a light intensity pattern that a light source makes when it illuminates a surface. Lamp manufacturers will identify beam patterns typically as spot, flood, or asymmetrical. Spot beam patterns focus the flux of the light near the center axis/normal of the light source. Spot beam patterns are a good choice when the designer is limited on power but needs as much light as possible for a specific location. Flood beam patterns have a wide dispersion of light flux from the center axis/normal of the light source. Flood beam patterns are a good choice when the designer is limited on the number of light sources allowed in an area but has a requirement for a wide and even dispersal of light. Asymmetrical beam patterns are not symmetrical around the center axis/normal of the light. They can have a focused or wide dispersion pattern. Asymmetrical beam patterns are often selected for lighting oblong shapes or for rectangular wall-wash effects. Figures 8.7-11 and 8.7-12, respectively, show the beam pattern a spot and a flood light at different distances from the lamp (Lighting Environment Test Facility, Johnson

Space Center). The space in this example is an 8'x 8'x8' with a ceiling and wall reflectance of 10% and a floor reflectance of 50%. Note how the dispersal of the light is different. Also note how the illuminance values change with the square of the distance from the light source. Beam patterns typically maintain their shape, despite increasing the distance from the light source. If surrounding surface reflectivity is minimal, the designer can perform rough estimates for lighting arrangement using a beam pattern template.

iW_Burst_Compact_Power Core_8_Degree Flood in a 8'x8'x8' L x w x h room, with reflectance (10,10,50) (ceiling, wall, floor)
 Calculated with Visual Lighting Software and IES photometric file.

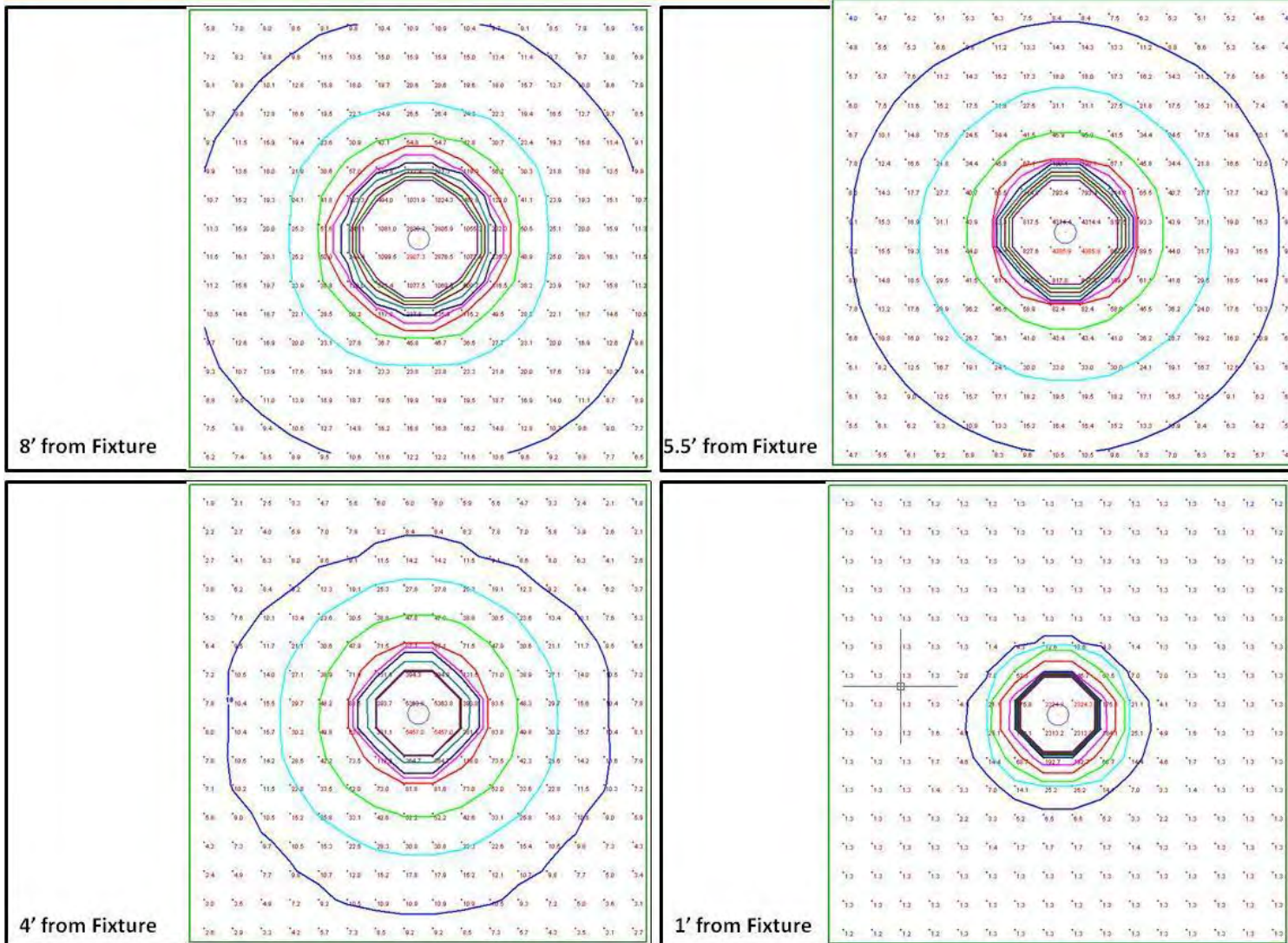


Figure 8.7-11 Spot beam pattern for LED lamp fixture.

iW_Burst_Compact_Power_Core_41_Degree Flood in a 8'x8'x8' L x w x h room, with reflectance (10,10,50) (ceiling, wall, floor)
 Calculated with Visual Lighting Software and IES photometric file.

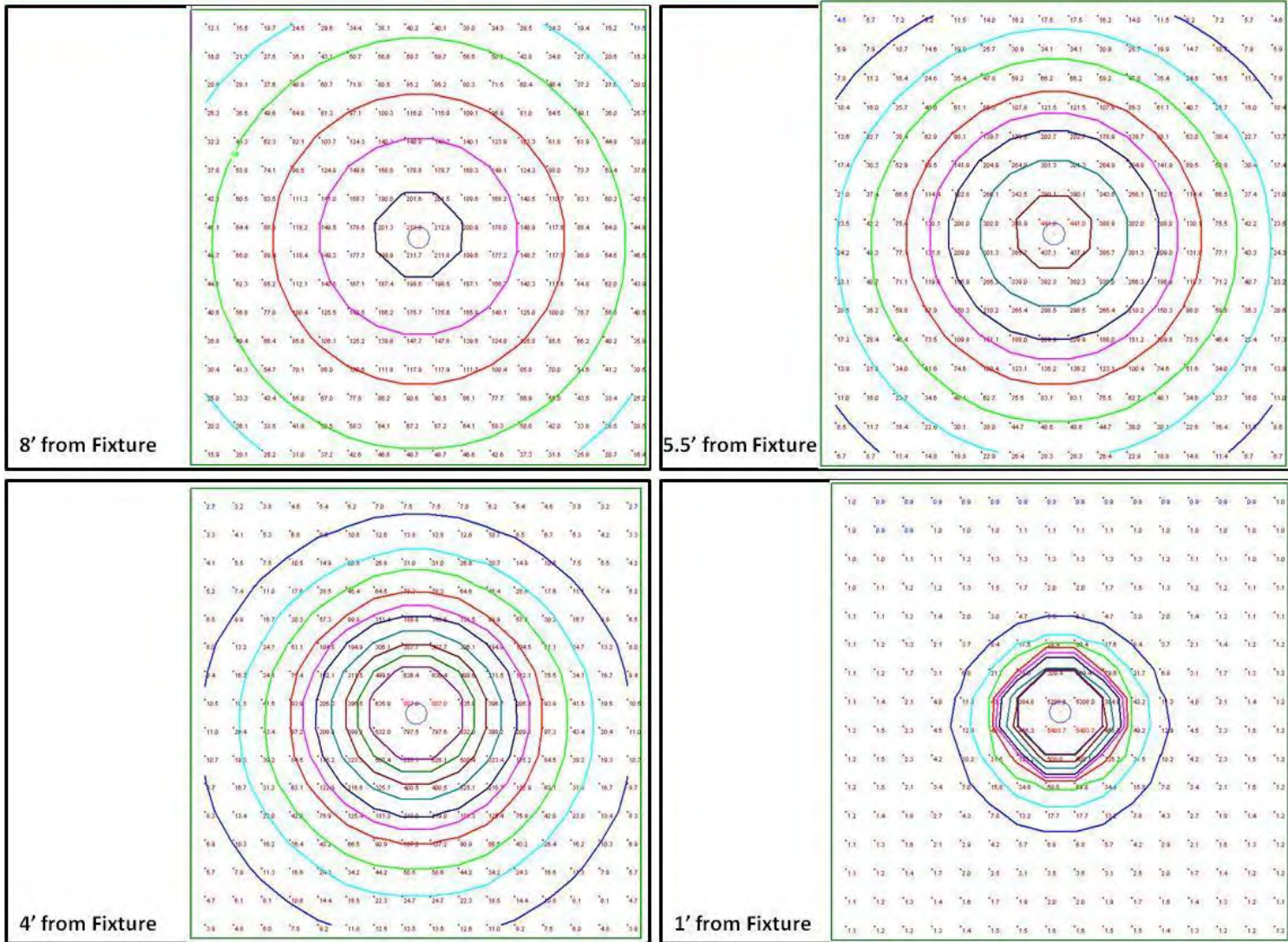


Figure 8.7-12 Flood beam pattern for LED lamp fixture.

8.7.4.2 Lamp Types

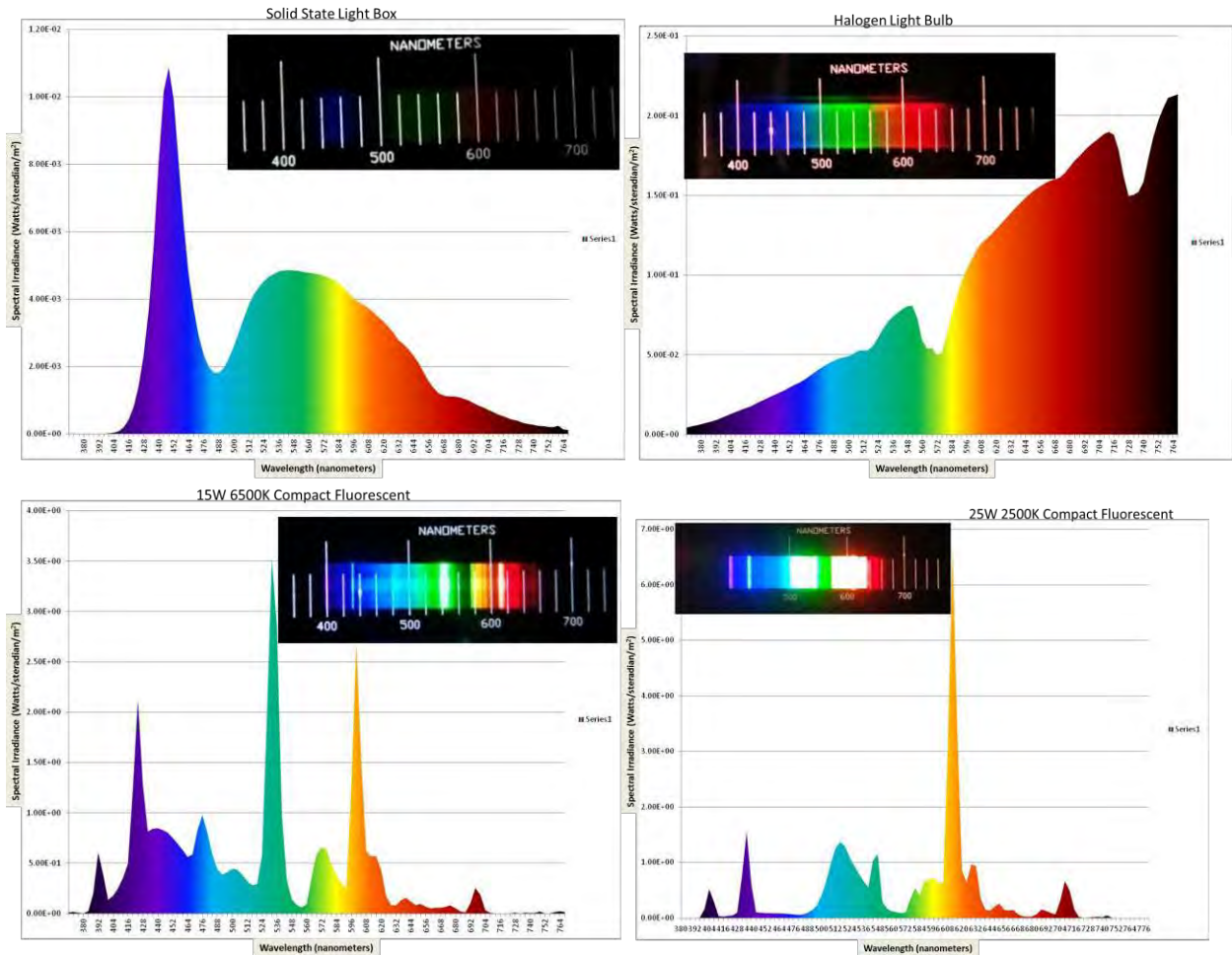
For general or task illumination applications, the primary types of lights in use are incandescent, fluorescent, high-intensity discharge, and solid state. For aerospace applications, the trend is toward solid state lighting solutions due to extreme environment effects. The spectrum or color of lights is also considered a factor.

Lamp Type	Typical Features
Incandescent lights	<ul style="list-style-type: none"> • Filament in a vacuum or gas-filled glass enclosure • Functional life times in the hundreds of hours • Lumens-per-watt is low
Fluorescent lights	<ul style="list-style-type: none"> • Low-intensity gas discharge devices • Create light by an electrically stimulated glowing gas • Typically used for interior applications • Functional life ranges from 7500 to 20,000 hours. • Lumens-per-watt is generally quite high
High-intensity discharge lights	<ul style="list-style-type: none"> • Create light using a highly stimulated gas technique • Produce high thermal conditions • Typically used outside for illumination at a distance and over a large area • Functional life ranges from 18,000 to 24,000 hours. • Lumens-per-watt is high
Solid-state lights	<ul style="list-style-type: none"> • Create light using solid-state electronics, the most common being the light emitting diode (LED) • Creating an effective multiple LED light source is not trivial, but the device is highly robust, capable of withstanding relatively high mechanic stress • Functional life ranges from 30,000 to 50,000 hours depending on electrical loads • The devices are relatively small with a medium to high lumens-per-watt rating

8.7.4.2.1 Lamp Color

The lamp selection process should consider the lamp’s characteristic spectrum. Each lighting technology has a signature spectrum (intensity of light at specific wavelengths). Depending on the application, the lamp’s spectrum could be a help or a hindrance to the intended lighting environment. If the lamp is intended for lighting an environment for human use (such as reading manuals or performing detailed tasks where color rendition is important), it may require a broad “white” lighting environment. Some lamps, due to their technology, generate intense

spikes of light at wavelengths that may affect local devices (such as sensors) or damage material (such as UV sensitive materials). Figure 8.7-13 contains spectral irradiance graphs that show the intensity of the light at specific wavelengths for various light sources (graphs generated by the Lighting Environment Testing Facility at Johnson Space Center using a Photo Research PR-655 spectrophotometer). Figure 8.7-14 shows the spectrum for the white LED lights used on the ISS (graphs generated by the Lighting Environment Testing Facility at Johnson Space Center using a BW Tek SpectraRad spectrophotometer). The spectrum is not continuous because the samples are taken in increments of nanometers). The more intensity of light that is weighted to one side of the color spectrum compared to the other side will cause the light to trend to a certain color. For instance, lamps with spectrums that are heavily weighted in the red or orange wavelengths will produce light that is “warm,” “yellow,” or “orange.” Lights that are heavily weighted to a section of the color spectrum will not produce a lighting environment that is good for color rendition. The decision to only select “white” lights or broad spectrum lights may not be a good solution if the lighting requirement heavily favors a solution that requires a narrow band wavelength.



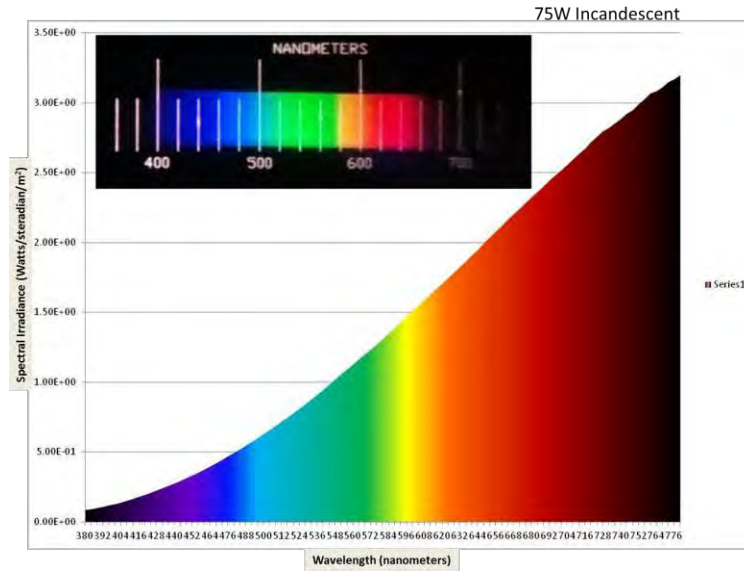


Figure 8.7-13 Spectral irradiance graphs for a variety of light sources.

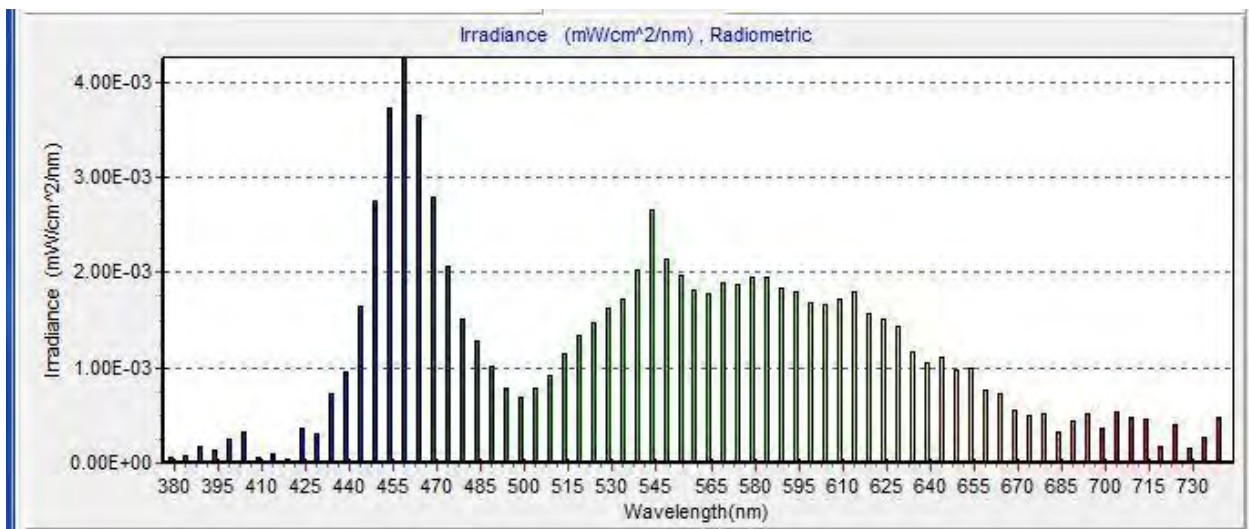
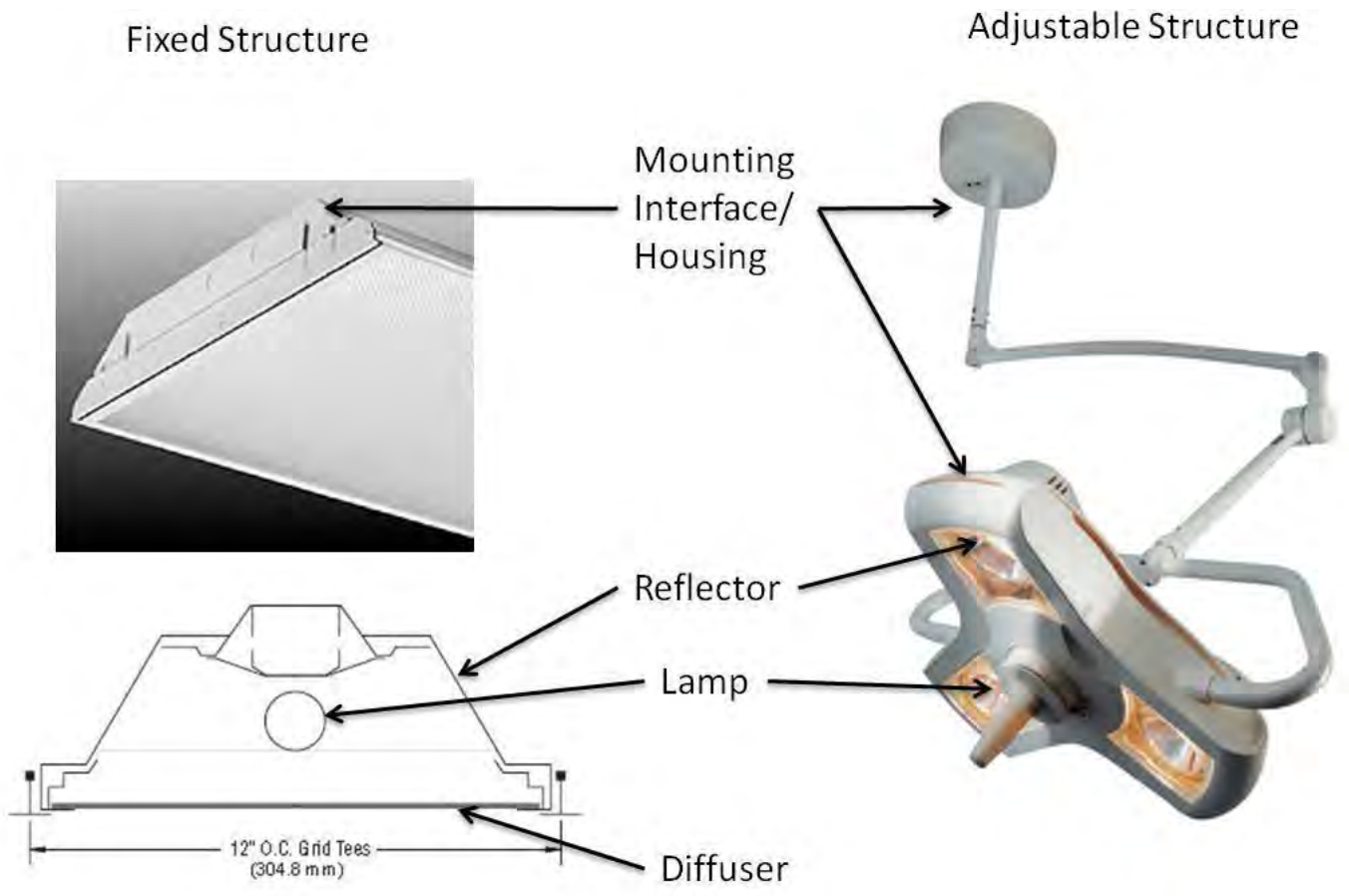


Figure 8.7-14 White LED light panel ISS prototype spectrum (measured).

8.7.4.3 Luminaires

A luminaire, or light fixture, is a device designed to house, provide power, distribute light, and manage heat of the lamp or lamps for which it was designed. A luminaire usually incorporates the following types of parts: power interface module, luminaire mounting interface, lamp mounting interface, reflector, and diffuser or lens. The shape of the luminaire is largely driven by the shape of the lamps it houses and the required beam pattern. The power interface module could be as simple as an electrical cable terminated to a lamp connector. It could also include complex electronics that may include some or all of the following: a ballast, an AC/DC converter, power and dimming control circuitry, color control circuitry, batteries, switches,

indicators, and system status displays. The luminaire mounting interface design depends on how the designer intends to install the fixture in its environment. Mounting interfaces range from simple brackets to hinge or ball bearing systems that allow for the light beam to be redirected by the user. The lamp mounting interface is usually driven by the connector, weight, safety, thermal, light distribution pattern, and structural requirements for the bulb. For many luminaires, the lamp is supported only by its interface with the connector, like light fixtures designed for incandescent Edison-base style bulbs and linear fluorescent bulbs. Most light fixtures that require any focusing or redirection of the lamp's light beam will employ a reflector. Reflectors can be made of a wide range of materials and surface types. Some reflectors are white glossy or diffuse surfaces, whereas others are highly metallic and specular. Reflector shape is driven by the shape of the bulb and the intended effect when combining a reflector with a specific beam pattern. Additionally, luminaires sometimes use a diffuser or a lens to disperse or focus the light beam, respectively. Diffusers and lenses are made from a wide variety of materials that include plastics, glass, and metal. Diffusers are often used to reduce glare and can also be used to adjust the color temperature of a light source. Figure 8.7-15 shows examples of very different luminaires. The fluorescent light fixture in the figure demonstrates a design optimized for general fixed lighting. The examination light fixture is designed for directional task lighting and can be adjusted by the user.



Philips DayBrite Recessed Fluorescent Luminaire

Philips Burton Aim-50 Examination Luminaire

Figure 8.7-15 Luminaire design examples.

8.7.5 Lighting Control

8.7.5.1 Control Location

Controls for general lighting within each module must be located within that module. This allows crewmembers to see the effect of changes to lighting controls without changing location. Controls for general lighting should be conveniently located near entryways to modules. These controls should also be located within easy reach of a crewmember at the cockpit flight control panel. Some areas, such as habitation airlocks, may require multiple control stations for lighting.

Task lighting at workstations must be controllable and adjustable by a restrained operator at the workstation.

8.7.5.2 Control Design

The dimming control should provide continuous (or a fine stepwise approximation to continuous) adjustment of the source luminance. When a rotary control is turned clockwise, or when a linear control is moved upward or to the right, luminance should steadily increase with each successive movement. If a control switch is moved in any of the opposite directions (counterclockwise, downward, or to the left), luminance should steadily decrease with successive movements. These light-control design recommendations are depicted in Figure 8.7-16. In keeping with Weber's Law regarding human perceptual sensitivity, the control should provide increments (ΔL) in luminance that are proportional to the value of luminance (L). For every equal incremental increase in the control setting, the luminance of the source should change by a constant ratio. This results in a logarithmic relationship between control changes and luminance changes. For example, if the control setting is increased by an increment, and this results in a doubling of the source luminance ($k = 2$ in Figure 8.7-17 for this example), a further equal increase in setting should result in a redoubling of luminance to four times the original value. A power pilot indicator should be included to signal when power is being supplied to the light source.

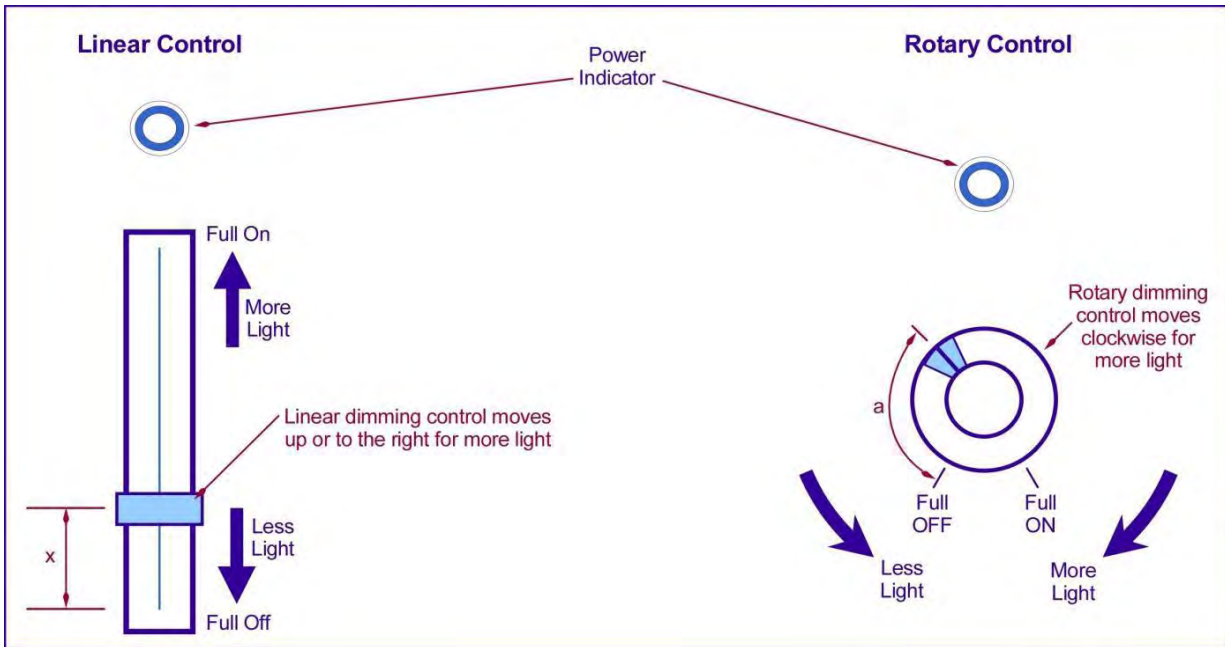


Figure 8.7-16 Lighting control operation.

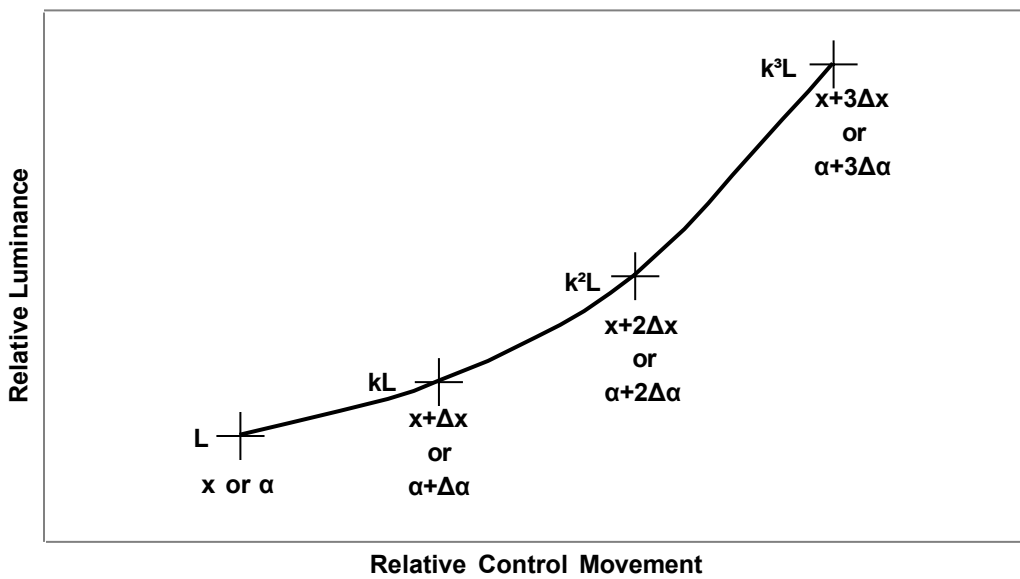


Figure 8.7-17 Lighting control movement and luminance. In the figure, x refers to linear control movement distance, and α refers to rotary control movement angle.

8.7.6 Lighting Color

The sensation of color depends on both the visible spectrum and the luminance presented to the eye. These quantities, in turn, depend on the spectrum of the illumination source and the

modification of that spectrum by absorptive characteristics of intervening transmitting or reflecting materials in the environment. For example, planetary atmospheric absorption and optical scattering from dust may significantly affect the selection of colorants for external signage on or in the vicinity of habitations. These factors should be considered in establishing requirements for the intensity and color of lighting on such objects as guide beacons and vehicle headlamps. For a specific color sensation to be reliably produced in an observer, the spectral reflectance of an object's surface (the "color" of the object) and the illuminant spectrum must be controlled. As an object is observed under different light sources, it is possible that the color sensations produced by it may change dramatically. This may introduce ambiguity into color-coding schemes or interfere with the aesthetic appreciation of objects in ways not anticipated by their designers.

White light has traditionally been defined in terms of the spectrum of a Planckian (black body) radiator, but the term "white" is used to describe a wide range of spectra. The spectrum (color) of a Planckian radiator is a smooth function of wavelength that is completely defined by the radiator's absolute temperature. Incandescent (filament) lamps produce spectral power distributions that are of the same shape as Planckian radiators, so the color of the light emitted from these lamps may be accurately described in terms of a corresponding correlated color temperature (CCT). Incandescent sources producing more short-wavelength (bluish) light are said to have a higher color temperature, whereas those producing more long-wavelength (reddish) light are termed lower color temperature sources. The CCT may also be calculated for irregular spectra unlike the Planckian variety, such as those produced by LEDs, fluorescent lamps, gas discharge lamps, and other nonfilament-type sources. The appearance of objects illuminated by such sources may, however, differ significantly from that obtained under illumination by filament sources having the same CCT. This discrepancy occurs when the spectrum of the nonfilament source includes peaks and/or gaps unlike the smooth Planckian spectral curve. Much more useful means of defining white-light properties are the systems of color coordinates established by the CIE. These systems are based on empirical studies of human color matching, providing numerical means of describing light color and relating spectra and luminance to perceptual performance.

The entire visible spectrum should be considered during design of lighting systems. Two lighting metrics previously included in NASA requirements – the CIE CCT and the CIE color rendering index (CRI) – should not be used for every design decision. The CCT may provide a shorthand method of describing the spectral power distribution for incandescent lamps, but it should be used with care with regard to non-incandescent lamp applications. If an incandescent lamp and a non-incandescent lamp are chosen to have the same CCT, the user should notice no difference when using each to read black text on white paper. Color rendering using the two lamps, however, could produce very different perceptions. An improvement in specifying the bluish-versus-reddish characteristics for all sources may be realized through using one of the variations of the CIE chromaticity coordinate system. The CRI attempts to summarize the color-rendering characteristics of a light source for all reflectance spectra. It does this summarizing through an average of eight color-shift metrics. The averaging process de-emphasizes the contributions of large color shifts to the metric. The reference source and coordinate system used for the eight color-shift calculations are no longer used for other applications. The use of more meaningful daylight reference sources and more uniform color coordinate systems for

calculating color appearance differences, in addition to more sensitive summarizing calculations, have been proposed. The main use of the CRI has been as a marketing tool for commercial manufacturers of non-incandescent light sources.

8.7.7 Circadian Entrainment

Lighting systems must provide the proper light for synchronization of the day-night cycle (circadian entrainment). Disruptions in sleep-wake cycles have been common among astronauts. These difficulties in establishing stable circadian cycles are similar to those experienced by people on Earth who work rotating shifts, air travelers traversing multiple time zones (jet lag), submariners, and some individuals enduring winter months at high latitudes (CIE, 2006; United States Congress, 1991). The human circadian cycle may be entrained by a variety of environmental stimuli, but by far the most influential is exposure to bright light. Successful treatment of seasonal affective disorder among inhabitants of higher latitudes has involved exposing them to high illumination levels for extended periods on a daily basis. Research suggests that visible blue light in the 450- to 480-nm range provides an alerting function to the brain (Brainard et al., 2001), and may aid in stabilizing circadian cycles. It is unclear whether the entraining blue light should be delivered exclusive of other wavelengths (Figueiro et al., 2003, 2005), which may become distracting or affect normal visual tasks. The ability to provide these blue wavelengths within a larger spectrum of white light, while still providing the alerting benefits, would eliminate the negative aspect of pure blue light.

8.7.8 Illumination for Dark Adaptation and Mesopic Vision

Sometimes a need exists for lighting systems to be designed for a vision range other than the photopic one. The mesopic and scotopic vision ranges for humans allow people to see and perform tasks in a relatively dark environment. If dark adaptation is required for tasks such as visually acquiring targets out a window, low illumination levels of white or red light must be provided for operations in the viewing environment. If the degree of required dark adaptation is not extreme, adjustable white lighting of the surroundings may be suitable. For maximum dark adaptation, the surroundings must be provided with low-luminance (0.07–0.34 cd/m²) red light. CIE states that chromaticity coordinates for this light should lie within the following limits: $0.663 \leq x \leq 0.705$, $0.295 \leq y \leq 0.335$, $z \leq 0.002$ (CIE, 2006).

Areas involved in operations requiring dark adaptation must be provided with shades over potential sources of stray light, such as windows. Closed doors should be capable of being made light-tight, with covers provided for hatch windows and other light sources.

More research should be done to optimize the development of lighting systems for the human mesopic vision range. This visual range does not require as much light and thus would not require as much power, potentially providing certain design advantages. Lighting systems that use minimal to no power to provide visual indication to their users are ideal for extreme environments where the availability of power is minimal, nonexistent, or would be dangerous to the user. Photoluminescent light sources do not require a power source. The ISS uses this type of light source for emergency lighting. Because the optimization of this type of system requires

the entire environment to be designed around a “dark adaptation” mode, much more research needs to be performed so that adequate system guidelines can be provided for a variety of human needs such as situational awareness, task performance, glare, control panel design, and visual display systems. Such systems could find their usage immediately beneficial for emergency lighting system designs. Additionally, systems designed for dark adaptation could be useful for external vehicle lighting and planetary exploration.

8.7.9 Signaling and Position Lights

Spacecraft acquisition strobe lights, orientation lights, and other signal lights should be designed for specific operational conditions. In particular, the patterns of luminance in the background surrounding the light as viewed by an observer and whether the light is flashing or in a steady state may determine signaling effectiveness. A useful example may be found in the case of an observer in low Earth orbit that needs to visually acquire another spacecraft for rendezvous. If the target has steady-state signal lights, the observer may not readily discern them when the spacecraft appears before an extensive, luminous backdrop, such as sunlit high-altitude cloud tops or ground covered by ice and snow. Looking toward the planetary surface from orbit over the night side of Earth, a signal light may be lost in the backdrop of urban light sources in some regions. Brief, infrequent strobe flashes may be obscured by frequent lightning strokes between thunderstorm clouds. Looking above the terminator or out into space from orbit on the dark side of the planet, steady-state or strobe signals may be lost in the starry background.

8.7.9.1 Minimum Intensity

The approximate minimum useful intensity criterion used in past NASA operations planning has been determined as that intensity that produces illumination at the eye equivalent to that of a third-magnitude star. This illumination level, approximately 1.68×10^{-7} lx in space, and the distance D (meters) from the eye to the signal light determine its minimum effective intensity (candela) requirement according to the “inverse square law”:

$$(I_{eff})_{min} = (1.68 \times 10^{-7}) D^2$$

8.7.9.2 Apparent Intensity

The apparent intensity of a flashing light depends on the ratio of the “on” time to the total repetition period, the “duty cycle” of the signal. The relationship between the effective and actual intensities for flashing lights is predicted by the Blondell-Rey formula:

$$I_{eff} = \frac{\int_{t_1}^{t_2} I dt}{0.2 + (t_2 - t_1)}$$

Here I is the actual luminous intensity of the source in candela, with t_1 and t_2 representing the start and stop times of the flash, respectively, in seconds. The effective intensity of the flash is always less than the intensity of the source, but a properly selected duty cycle can make a flashing signal more conspicuous than a more intense steady-state signal.

Tests to determine the visibility of the Lunar Module tracking light used during the Apollo Program showed that the xenon flash lamp having $\int_{t_1}^{t_2} I dt = 1000 \text{ cd} \cdot \text{sec}$ and flash duration $(t_2 - t_1) = 20$ milliseconds was visible at a distance of 130 nautical miles (Wheelwright, 1973). From the Blondell-Rey relationship, this flash will produce a value of $I_{eff} = 4545 \text{ cd}$. At 130 nautical miles in space, the illumination produced by this I_{eff} is $7.83 \times 10^{-8} \text{ lux}$, less than half the third-magnitude star illumination threshold given above. This result implies that the third-magnitude star heuristic may be conservative. It is important, however, to know that the minimum illumination threshold and the Blondell-Rey relationship depend on several assumptions. These are (1) the target is emitting light at a constant intensity, (2) the observer is dark-adapted to a great extent, (3) the observer has nominal 20/20 or better distance vision acuity, (4) the observer has no local light sources or veiling glare in the field of view, and (5) the observer is searching for the lighted target against a dark background. The third-magnitude star threshold heuristic serves as a useful starting point for design. In many conceivable situations, however, the intensity of a flashing signal may need to be increased significantly above the threshold values given to produce a reliably detected and interpreted signal.

8.7.9.3 Flash Rate

The repetition rate of the flash needs to be fast enough to ensure that, both the onset and end of the light pulse occur during the interval between saccadic movements of the eye – about one third of a second.

All-white marker lamps were used on one ISS resupply spacecraft, the Automated Transfer Vehicle. The location of each lamp is encoded in the “blink frequency” of its flashing pattern. One pattern is a steady “on” state without flashing. The other three patterns consist of alternating, equal-duration on and off periods. The flashing patterns of these lamps are free-running and not mutually synchronized. The “on” durations assigned to the different lamps are 0.5, 1.0, and 2.5 seconds, respectively. The disadvantage of this system becomes apparent when one considers the case when only one flashing lamp is visible for reasons such as spacecraft attitude or obscuration by solar panels. The observer needs to decode the visible flash pattern according to her/his sense of time passage, which is usually poor. An alternative to this approach, which offers easy identification of a single flashing white light, is to use a simple pulse-coding scheme. For example, consider the case in which one of the flashing lights emits a single short pulse followed by a 1-second off period. Let one of the other flashing lights emit two short pulses in quick succession followed by a 1-second off period, and let the remaining light flash three times in quick succession followed by a 1-second off period. If only a single light is visible, the observer can identify which light is which by merely counting the number of flashes occurring during a repetition period. This method does not involve using the unreliable human sense of time passage. Any preference for the all-white marker approach over a standard colored marker-light approach would have to be driven by operational considerations, such as the likelihood of one or more crewmembers being color-blind (if this is allowed).

8.7.9.4 Signaling and Position Light Color

Color coding based on aviation navigation light standards has been adapted in general for orientation cues on spacecraft. The hue of these lights can appear to change with luminance variation even though the spectrum of the light does not change. This phenomenon is described as the Bezold-Brücke effect. Three wavelengths exist for which the hue does not shift with luminance changes in a constant source: 475 nm (blue), 507 nm (green), and 570 nm (yellow). These wavelengths for constant hues shorten for brief flashes of light: 470 nm, 504 nm, and 555 nm, respectively. Colored orientation and marker lamps should be selected from these according to application. As the luminance of a green or red source decreases, its hue tends to become more yellow. The effect is most pronounced at low luminance levels below 10 cd/m², but the designer needs to verify that for extreme oblique viewing angles it is not as likely a source of confusion as more luminous marker lights are.

8.7.10 Lighting of Control Panel Legends

Operations should be a prime consideration in setting the nominal indicator luminance on control panels. Self-illuminated markings on control panels are advantageous when an operator has to maintain a high degree of dark adaptation while referring to the markings. Such a need might arise in a spacecraft cockpit when the mission task requires visually searching for a dim, distant target outside the window while operating panel-mounted controls. Dimmable lights are necessary for these tasks as well as for sleeping.

Examples of self-illuminated legends used in spacecraft include those backlighted legends by individual incandescent lamps, LEDs, or photoluminescent sheets, as well as those illuminated by remote sources through optical means, such as wedge-lighted or edge-lighted control panels. Use of a self-illumination feature in combination with a dimmer allows the luminance of the control panel legends to be continuously adjusted to a very low but legible level (on the order of 0.1 cd/m²), while stray reflections and contrast variation over the control panel area are minimized. Self-illumination provides a degree of control at low lighting levels that is difficult to achieve with floodlighting of reflective markings, especially over a wide panel expanse. Self-illuminated displays were used in the Space Shuttle cockpit, and were used exclusively in the Apollo spacecraft, with contingency floodlighting provisions in case of failure of the primary lighting system.

8.7.10.1 Indicator Luminance Settings

No single hard-and-fast threshold value exists for indicator luminance requirements. Humans adapt to the surrounding “average” luminance environment, and a glaring bright indicator light in the field of view can, in some cases, be as troublesome as one that is barely perceptible.

The final selection of the LED luminance levels may need to be made based on mock-ups or other physical evaluations. However, some useful guidelines from human factors help bound the possibilities and get the selection process started. MIL-STD-1472F §5.2.2.1.8 is a useful source. It states that the luminance of transilluminated displays should be set to at least 110% of the

surrounding [panel] luminance; however, “where glare must be reduced,” the display should be no more than 300% of the surrounding luminance. When applied to a predicted maximum panel luminance level of 10 cd/m², for example, these guidelines would set the minimum LED luminance under the brightest cabin lighting conditions to 11 cd/m². Under the same bright conditions, the maximum luminance to avoid glare would be 30 cd/m².

The luminance levels for the panel LEDs should vary according to application. The dimmest would be the backlit legends for control switches and indicators. Adhering to MIL-STD-1472F §5.2.2.1.8 would lead to setting the maximum backlight luminance for our example to 11 cd/m². The backlit legends can be dimmed below this level for low-light operations. Intermediate in the LED luminance range are the indicators of the various system states. The remaining LEDs are used to signal caution and warning conditions. These few have the highest luminance to contrast with the background and should be conspicuous. To begin, the caution and warning indicators for the example might be set to the maximum luminance level of 30 cd/m². Ideally, the luminance levels of all these indicator types should be proportionally adjustable by a single “brightness” control.

What should guide the choice of the intermediate luminance level to indicate systems’ status? Weber’s Law from human factors studies implies that the perceived “midpoint” between two stimulus levels lies at the geometric mean (square root of the product) of the two levels. This midpoint value offers the best choice for distinguishing it from two adjacent luminance (brightness) levels. If the backlight luminance is 11 cd/m² and the caution and warning luminance is 30.9 cd/m², accordingly the indication luminance level should be 18.2 cd/m². If this value is deemed too bright for nominal operating conditions, a more desirable backlight luminance might be substituted for the maximum value of 11 cd/m² and a reduced geometric mean value determined. Similarly, if the caution and warning annunciator luminance level of 30 cd/m² is found to be too high or too low to be compatible with expected operations, the indicator luminance value can be determined by applying the same procedure using the revised annunciator luminance and the selected backlighting luminance.

Tolerances for LED luminances should be proportional to the nominal settings. In the worst case, the tolerances should allow no overlap among the three functional luminance levels.

8.7.10.2 Indicator/Annunciator LED colors

The chromaticity requirements for transilluminated indicators from legacy requirements NASA-STD-3000 §9.5.3.2.i.4 primarily addressed applications for incandescent lamps with colored filters. For the most part, these requirements do not specifically comprehend the characteristics of LEDs, but define allowable chromaticity ranges that are perceived as desaturated colors whose chromaticity coordinates lie mainly well within the spectrum locus (outer boundary) of the CIE xy chromaticity diagram (Figure 8.7-18). Saturated colors are more easily distinguished from one another, and they are easily identified by their particular dominant wavelengths. The chromaticity characteristics of completely saturated colors lie along the spectrum locus. The monochromatic wavelength most closely matching the chromaticity of a light source is termed its “dominant wavelength.” The dominant wavelength corresponding to a set of desaturated chromaticity coordinates may be plotted in CIE xy space as the intersection of a line drawn from the reference white chromaticity point near the center of the xy diagram through the desaturated

point with the spectrum locus. This technique is illustrated in Figure 8.7-18, in which the assumed reference white point chromaticity ($x = 0.3127$, $y = 0.3290$) corresponds to the CIE 6500 K daylight (D65) standard. LEDs produce highly saturated, nearly monochromatic spectra, which are very suitable for indicator applications and whose chromaticity lie along or very near the spectrum locus. So an indicator color having a given dominant wavelength can be implemented by using a broad-spectrum incandescent lamp and a filter that absorbs undesired wavelengths. The same color indication may be achieved by employing an LED that intrinsically emits only a very narrow band of wavelengths around the desired dominant wavelength. The chromaticity of the LED's emitted spectrum will likely lie mostly outside the filtered lamp's chromaticity region. Figure 8.7-18 offers a comparison of chromaticities for color coding drawn from incandescent-based indicator requirements and commercial LED specifications. Corresponding ranges of dominant wavelengths for these sources are compared in the following table.

Table 8.7-3. Comparison of dominant wavelength ranges for the example of Figure 8.7-18.

Indicator Color	Source Type	Dominant Wavelength (nm)	
		Minimum	Maximum
Green	Incandescent + Filter	515	535
	LED	520	535
Yellow/Orange	Incandescent + Filter	581	592
	LED	583	595
Red	Incandescent + Filter	638	>780
	LED	615	635

The green and yellow/orange LEDs selected for this example have dominant wavelength ranges that fit well with chromaticity limits shown in Figure 8.7-18, but the red LED dominant wavelength range lies outside the specified filtered incandescent chromaticity range. The selection of LEDs should be made based on explicit requirements for acceptable LED dominant wavelengths with commercially obtainable device characteristics. Color discrimination between selected LEDs in any case should be verified by testing with human subjects possessing color vision capabilities representative of the intended user population. Of utmost importance is the principle that there should be no overlap in allowable dominant wavelength ranges for the different colors used. Position coding or flashing should be considered in addition to color coding for critical annunciator applications.

8.7.10.3 Lamp Test Capability

LED indicators for conditions that are not flight critical may point to adverse circumstances that are precursors to problems for the mission. If a lamp provides the **only** indication of an off-nominal system operation, the indicator for that status should have a “lamp test” capability. Operations knowledge is needed to rationally make the decision whether to include this capability.

8.7.10.4 LED Drive Current Control

Light output power (and apparent brightness) from an LED is essentially directly proportional to the current flowing through it. This eases somewhat the design of LED drive circuits to provide a dimming function. The primary factor influencing this direct proportionality is junction temperature of the LED. As the junction temperature increases, the light power decreases. Increasing forward current through the LED to increase light output produces higher power dissipation within the LED and hence higher junction temperature. The best way to mitigate this effect is to drive the LED with temperature compensated, regulated direct current, whether constant or pulsed. This method provides minimum power dissipation and changes in junction heating, which offers maximum luminance stability over temperature, in contrast to using simple resistive current limiters. The use of regulated current to drive the LEDs simplifies the implementation of the guidelines in §8.7.10.1 above.

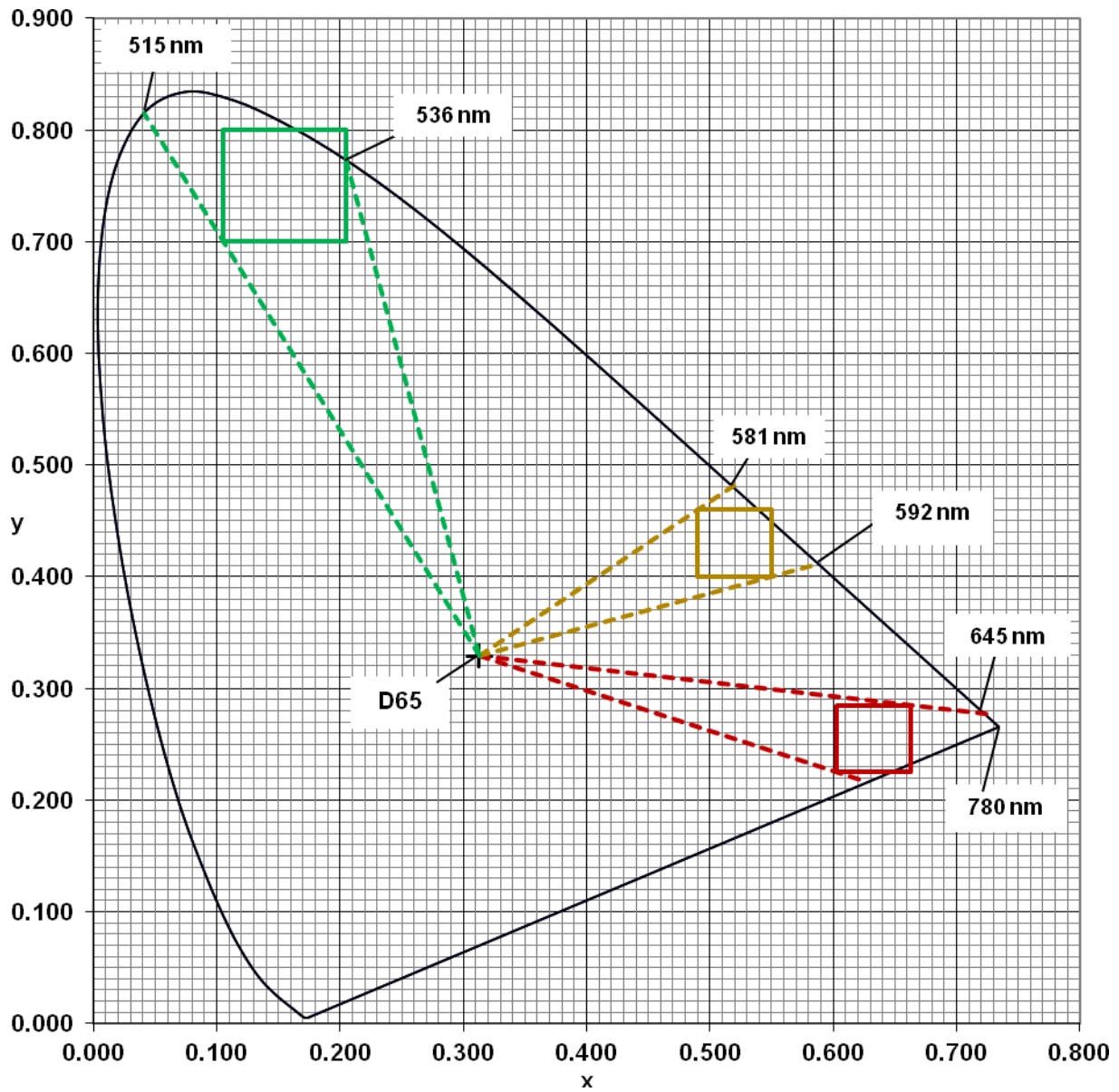


Figure 8.7-18 Dominant wavelength determination for LED and incandescent indicators.

8.7.11 Architectural Lighting System Design

A lighting system should be considered part of the overall system design solution. The effectiveness of a lighting solution can be dramatically impacted by the selection and design of materials and structures surrounding a light source. This section will discuss recommendations on how to develop system lighting requirements and implementation of lighting requirements

into a lighting system design solution. A successful lighting project will necessitate synergy from all project components, from requirements development, to coordination between project managers, and mechanical, electrical, materials, and thermal engineers. Lighting system project planners should expect a rework process as light sources are selected and evaluated for an optimal design that incorporates all requirements. Planners should estimate needs for laboratory lighting evaluations, physical mock-ups, and computer simulations to evaluate and design a system lighting solution.

8.7.11.1 Lighting System Design Process

Figure 8.7-19 gives an overview for the process of designing a lighting system. This flowchart should be used as a guideline to help the designer consider as many factors as possible when designing a complete lighting system. This chart shows a majority of the work focused on the design of the luminaire or its placement within a system. The designer should also consider it part of his or her task to evaluate the materials properties of the surfaces near the proposed lighting system and any other lighting system that is not part of the design that could be contributing light to the proposed lighting environment. When possible, the designer should provide feedback to architectural system planners and project managers when it is discovered that the materials near a light source are affecting its usability or impacting other issues, such as power and minimum lighting levels.

A lighting system includes many factors, such as the user, the materials around the light source, the physical design of the light source, controls, power and power quality, manufacturing limitations, environmental controls, and stowage. Lighting design is an iterative process with extensive calculations that are best served via computer graphics analysis and lighting analysis software. The designer should consider the usage of commercial off-the-shelf products prior to designing a custom solution because lighting manufacturers have invested large amounts of research into producing lighting systems that are cost effective, reliable, and reproducible. Designing a well-engineered lighting system takes cooperation from the entire project team and patience in selecting the best path forward.

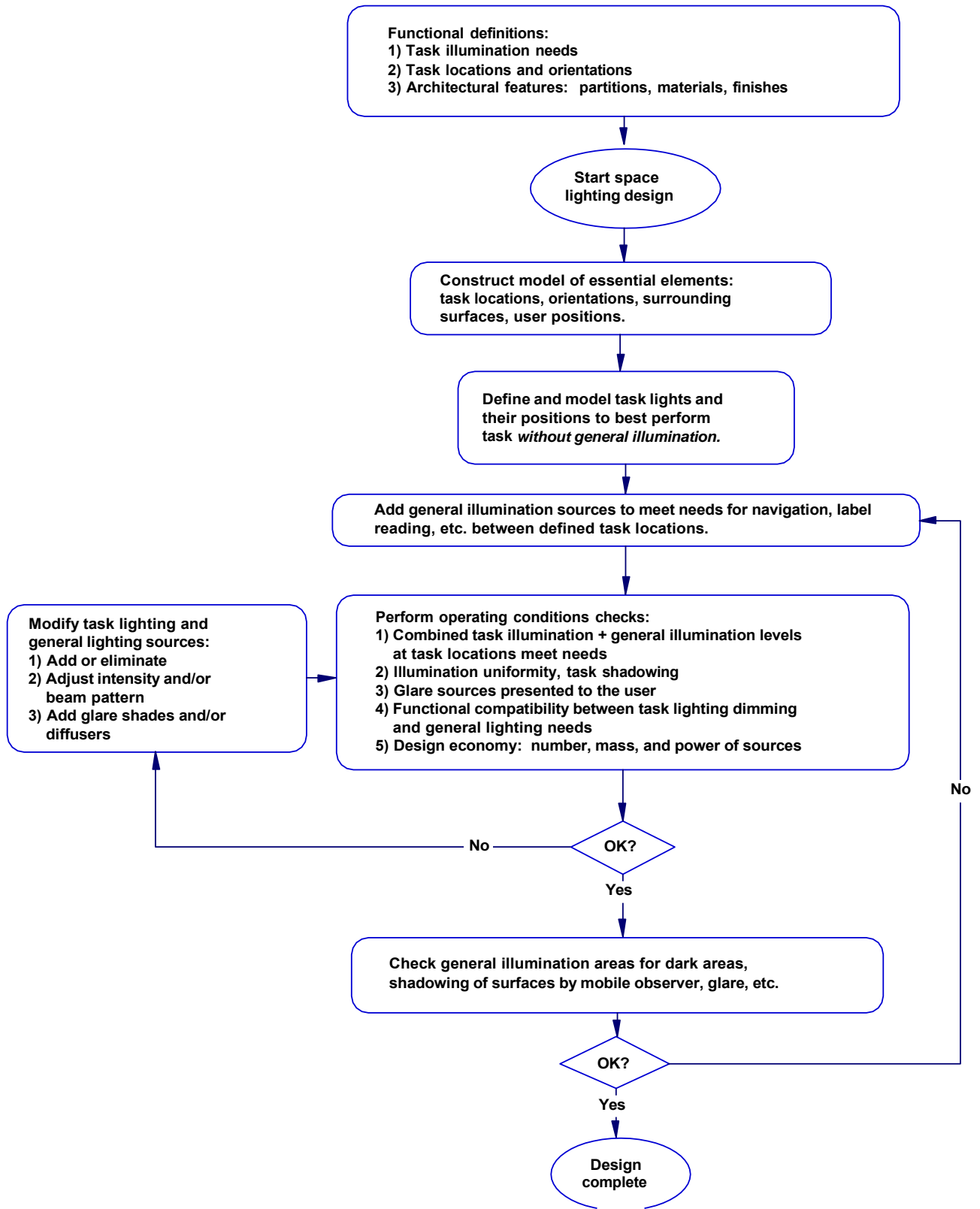


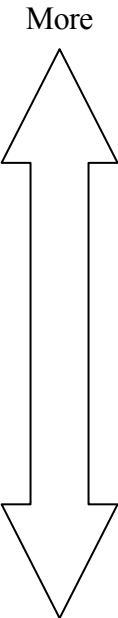
Figure 8.7-19 Lighting system design process.

8.7.11.2 Lighting Needs

The first step in the design process is to define the task demands and construct a model of the lighting environment.

- *Task Demands* – Requirements must be based on functional analysis of the mission and tasks to be performed. Optimal lighting system design cannot be methodically pursued without specific requirements addressing the needs of operators performing specific tasks. The amount and type of lighting required depends on the nature of the task. ISS crewmembers have indicated the importance of providing smaller task lighting or portable lights for maintenance work behind panels. A ranking of typical task illumination recommendations is given in Table 8.7-4. This table is adapted from *The IESNA Lighting Handbook* published by the Illuminating Engineering Society of North America (IESNA, 2000). Note that acceptable illumination levels for different individuals and cultures vary substantially (Boyce, 2003; Nicogossian et al., 1994). Absolute minimum illumination requirements must be determined on the basis of the tasks being performed and the likely state of adaptation of the user in the environment.
- *Architectural Features* – Lighting requirements must take into account the architectural features of the spacecraft. Lighting models should include locations and orientations of all work surfaces in relation to their surrounding architectural features. Models should also include accurate representations of the operator(s) in relation to the workstation. These features should include working eye locations and body dimensions and postures that may affect the obstruction and reflection of light during task performance. The reflective properties of the various surface materials should be included in models to allow the accurate estimation of luminance and illuminance.
- *Luminance Adaptation Effects* – Illuminance requirements for interior volumes in spacecraft and habitations must be determined in accordance with the anticipated operating luminance conditions. The following should be considered for luminance adaptation:
 - The visual system is capable of performing well throughout a range of surrounding luminance values without experiencing fatigue or eyestrain.
 - In some situations, areas designated for low-light operating conditions (such as sleeping or in conjunction with window observation stations) may need to be shielded from “spill lighting” originating in adjacent areas of higher luminance. Illumination requirements for such areas should consider conditions both with and without treatments for luminance control, such as removable partitions, curtains, or dimmers.
 - Factors affecting surrounding luminance also include the reflective properties of surface materials.
 - Determining the adaptation luminance level in a space may present a daunting simulation challenge to the requirements writer or designer.
 - Reasonable estimates for complex environments may need to be established using representative mock-up evaluations.

Table 8.7-4 Minimum Lighting Level by Task

Task	Measurement Location	Minimum Illumination (lux)
Invasive wound care (cleaning/suturing)	At treatment surface (mucosa or skin)	~500
Reading	On the page to be read	
Handwriting/tabulating – ink on white paper	On the paper	
Fine maintenance and repair work	On the affected component surface	
Food preparation	On food preparation surfaces	
Dining	On intended dining surfaces	
Grooming	On the face, located 50 cm above center of mirror	
Noninvasive wound care	On the wound	
Exercise	On the exercise equipment	
Video conferencing	On the face(s)	
Gross maintenance/ housekeeping	On surfaces involved	
Mechanical assembly	On the components involved	
Manual controls	On the visible control surfaces	
Panel – dark legend on light background	On the panel surface	
Waste management	On the seat of the waste collection system	
Translation	At all visible surfaces within the habitable volume	
Panel – light legend on dark background	On the panel surface	
Emergency equipment shutdown	On controls	
Night lighting	On protruding surfaces	
Emergency egress	On protruding surfaces	~10

Once illuminance control points such as those listed in Table 8.7-4 have been defined, the designer is faced with an iterative process of selecting light source intensities, beam patterns, positions, and directions to meet task guidelines. The initial lighting system design process of selecting the type and number of light sources (including exterior light sources) and their optimal placement is best accomplished using a computer-based lighting simulation tool. Such a tool should include ray-tracing features that account for the effects of interreflection among surfaces in the environment.

8.7.11.3 Defining Minimum Lighting Levels

Lighting must be provided at levels that support task performance. Determining whether adequate luminance contrast is available to perform a visual task at many positions and

orientations within an environment is, in most cases, impractical; therefore, designers of terrestrial lighting systems commonly begin from a common set of assumptions. These assumptions may be found in lighting design handbooks such as the *IESNA Lighting Handbook* (IESNA, 2000), which includes tables of recommended illumination values for a very wide range of tasks and environments. Such a handbook provides a useful lighting design procedure for relatively large, open volumes lighted primarily by a single, uniformly luminous surface (typically the ceiling). The key to this approach is to predict and be able to control the illuminance on specified surfaces within the environment. The following assumptions made in these handbooks, however, do not always apply to spacecraft:

- Usually, the surfaces of interest are assumed to be the walls and floor of the environment in addition to work surfaces above and parallel to the floor.
- The surfaces are assumed to be reflective enough to promote the required luminance contrast and diffusion of light throughout the space.
- General illumination is usually assumed to emanate from diffuse sources in the ceiling above the floor and work surfaces, whereas supplemental task illumination may be provided by downwardly or obliquely directed sources above the work surfaces.
- General office lighting, for example, is usually measured at the height of a desktop above the floor.
- In a large, uniformly lighted volume, the number and position of occupants may not significantly affect their ability to perform visual tasks.

As the volume and the number of sources decrease, the illumination pattern becomes less uniform and more dependent on the observation position. Most spacecraft envisioned at the time of this writing fall into this latter category. Also, in 0g conditions, no distinct “floor” or “ceiling” orientations exist.

If lighting requirements are established on the basis of illuminance control for the typically smaller, more complex space environments, the requirements must be qualified as to the specific location for the measurement and the orientation of the measuring device relative to the surface. Under these conditions, only loose correlations exist between illumination levels at different points within the environmental volume. Illumination levels must be defined for critical work surfaces under anticipated operating conditions. Once these levels have been defined, the designer is faced with an iterative process of selecting light source intensities, beam patterns, positions, and directions to meet task guidelines.

8.7.11.4 General Lighting

After independent estimates of the task lighting source characteristics (e.g., intensity, beam pattern, placement, and time intervals of use) have been established, general illumination needs must be determined. These should include minimal needs for obstacle avoidance while translating, and tending to routine environment control operations such as adjusting light source and airflow control settings, opening hatches, and operating intercom controls between workstations. Some areas may need higher general illumination levels for reading or other activities requiring greater visual acuity.

8.7.11.5 Fixtures for Lighting Tasks

As illustrated in Figure 8.7-10, task illumination sources should initially be considered in the absence of any general illumination. After the establishment of a model or a series of models representing task conditions, light sources should be added to the model to meet the task illumination needs. Actual minimum values determined should reflect the anticipated operational conditions. These conditions include the state of operator adaptation with regard to general ambient illumination levels and color. Ultimately, the task illumination sources need to provide the required illumination uniformity and not produce glare either at or between their associated workstations.

Fixed task lighting fixtures must be:

- Dimmable from their minimum output level to their maximum luminance.
- Adjustable in position and/or direction to avoid shadowing and glare during operations.

Design recommendations for portable task lighting fixtures include:

- Battery powered – Portable task lights should be battery powered to avoid entangling, restrictive power connections.
- Rapidly charging battery pack – A discharged battery pack should be capable of being rapidly exchanged for a charged pack to allow essentially continuous operation.
- Continuous operations – Portable task light lamps should be capable of continuous operation without significant performance decrease due to self-heating or producing exposed surface hot spots exceeding touch temperature limits.
- Adjustable beam – The beam of a portable task light should be adjustable for flood and spot lighting functions.
- Contingency operations – In contingency operations, a portable task lamp may need to be capable of providing useful levels of illumination when operated by a suited user, starting in cold-soaked conditions and operating for extended periods in a near vacuum.
- Temporary anchoring – Some means of temporarily anchoring the lamp to the user or spacecraft superstructure may be important to free the user's hands during operation.

8.7.11.6 Emergency Lighting

Emergency lighting must be provided in all spacecraft. Emergency lighting must allow crew egress and/or operational recovery in the event of a general power failure. The emergency illumination system must be automatically activated to serve the following purposes:

- Allow operators and other occupants of a spacecraft to move to a safe location, and allow efficient transit between any inhabited location and designated safe haven(s). Efficient transit includes appropriate orientation with respect to doorways and hatches as well as obstacle avoidance along the egress path.
- In some cases, allow occupants to perform contingency operations such as activating or shutting down critical equipment.

Selection of emergency illumination levels should take into account the likely states of luminance adaptation among occupants. Emergency sources in sleeping quarters or in low-light work areas should not have luminance levels so high as to cause extreme glare sensations among the occupants as they adapt to elevated emergency luminance levels. For execution of

emergency procedures, this recommendation needs to be balanced against the general illumination needs.

In some cases, the use of photoluminescent (“glow-in-the-dark”) direction markers for orientation and egress may provide practical adjuncts to powered emergency lights, especially in constantly illuminated areas. Any such applications should consider the means of “charging” the photoluminescent material by exposure to light, the length of exposure needed to provide useful glow luminance, and the persistence of the glowing indication after removal of the excitation. Photoluminescent material is not very useful in a volume that may remain dark for extended periods during normal operations. If an emergency occurs while the material is completely “discharged,” it cannot provide lighted guidance during egress. The need for nominal low-light operations may, in some instances, also prove incompatible with the use of photoluminescent emergency guidance markings. Such cases may include sleeping quarters or workstations for tasks requiring dark adaptation of the operator.

8.7.11.7 Integrating Overall Lighting

Once initial independent estimates for the general and task source illumination have been made, the interaction between the illumination patterns established by the various sources should be considered. In some cases, light source intensities may be adjusted or eliminated altogether if operational considerations determine that adequate illumination is consistently available. Elimination of extraneous light sources can pay handsome dividends in power requirements and in mass reduction, since the mass of the lighting system includes interconnecting wiring and control hardware as well as devices for heat transfer from the lights.

8.7.11.8 Lighting Analysis Techniques

System lighting design will require the designer or lighting expert to use a suite of tools to perform their evaluation. This section will identify the various methods for performing lighting analysis. The exact needs are project dependant and will affect the method chosen. It is important for programs to iteratively assess the lighting design, if the program/project involves any significant lighting systems.

8.7.11.8.1 Manual Lighting Analysis

A variety of techniques are used to calculate illuminance at a specific location. This section will focus on the methods that are most widely used.

8.7.11.8.1.1 Inverse Square Law Method (Illuminance at a Point)

When calculating illuminance at a point, two items are required: the Direct Component and the Reflected Component. Their sum equates to the total illuminance at the point in question. For calculating the direct component, this method requires the distance from the source to be at least five times the maximum dimension of the source. Using these criteria, the illuminance is proportional to the candlepower of the source and inversely proportional to the square of the distance in a given direction. Following is the formula for calculating the illuminance using the

inverse square law, where β is the angle between the light ray and the normal to the surface under evaluation (see Figure 8.7-20).

$$\text{Illuminance on Plane } B = \frac{\text{Luminous Intensity of Source in Direction of Ray}}{(\text{Distance from Source to Point on Plane})^2} \times \cos \beta$$

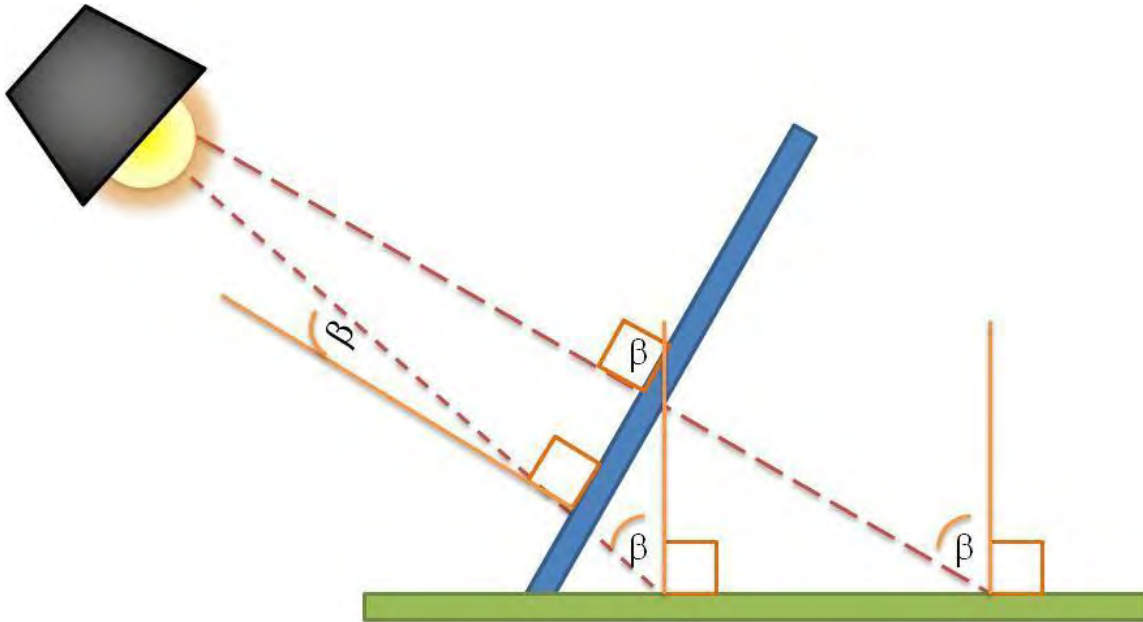


Figure 8.7-20 Inverse square law point illuminance example.

If the point to be measured is exposed to reflected light, the reflected light component is calculated by multiplying the percent reflectance against the calculated illuminance on the plane of the reflectance source. This reflected component is then treated as a light source, and the rules of the inverse square law are applied to estimate the total illuminance at the point in question. The calculations can be extensive if there are multiple light sources and a lot of surfaces to consider.

8.7.11.8.1.2 Lumen Method (Zonal Cavity Method)

An average illuminance calculation method called the Lumen Method can be used in a lighting environment where the luminaires are spaced to obtain a uniform illuminance. This method calculates the illuminance that represents the average of all points on a work-plane. Next to complicated detailed modeling of the lighting environment, the Lumen – otherwise called the Zonal Cavity method – is the quickest way to estimate ambient lighting levels for designs intended to provide the same illuminance over a broad area. Following is a set of calculation terms and factors used by the Zonal Cavity method. An example worksheet is provided in Figure 8.7-21.

Effective Cavity Reflectance can either be obtained from IES tables on percent effective cavity reflectance values or it can be calculated using the following set of formulas (Matthews, 1993). The definitions for the terms in these equations are as follows:

ρ_{eff} , ρ_W , ρ_B , are respectively the effective reflectance, the wall reflectance, the base reflectance.
 A_W , A_B are respectively the area of the wall and the area of the base.
 f is the form factor between the cavity opening and the cavity base.

$$x = \frac{\text{Cavity Length}}{\text{Cavity Depth}} \quad y = \frac{\text{Cavity Width}}{\text{Cavity Depth}}$$

$$f = \frac{2}{\pi xy} \left\{ \ln \left[\frac{(1+x^2)(1+y^2)}{1+x^2+y^2} \right]^{1/2} + y(1+x^2)^{1/2} \tan^{-1} \left[\frac{y}{(1+x^2)^{1/2}} \right] + x(1+y^2)^{1/2} \tan^{-1} \left[\frac{x}{(1+y^2)^{1/2}} \right] - y \tan^{-1}(y) - x \tan^{-1}(x) \right\}$$

$$\rho_{\text{eff}} = \frac{\rho_B \rho_W f \left[\frac{2A_B}{A_W} (1-f) - f \right] + \rho_B f^2 + \rho_W \frac{A_B}{A_W} (1-f)^2}{1 - \rho_W \frac{A_B}{A_W} (1-f)^2 - \rho_W \left[1 - \frac{2A_B}{A_W} (1-f) \right]}$$

A worksheet to calculate the number of luminaires or the illuminance with the assumption of an average maintained illuminance is shown in Figure 8.7-21 (Matthews, 1993). Manufacturer datasheets and the IES Handbook (Matthews, 1993) contain charts that can assist with the determination of the various factors shown in the worksheet. With experience, assumptions can be made for quick lighting estimates.

Zonal Cavity Method Worksheet

Project Name: _____

Average Illuminance for Design: _____ lux

Luminaire Data	Lamp Data
Manufacturer:	Type and Color:
Catalog Number:	No. per Luminaire:
IES Filename:	Total Lumens per Luminaire:

$$\text{Cavity Ratio} = \frac{2.5 \times (\text{Cavity Height}) \times (\text{Cavity Perimeter Length})}{(\text{Area of Cavity Base})}$$

	Height	Perimeter	Area	Cavity Ratio	Effective Cavity Reflectance
Room (RCR)					
Ceiling (CCR)					
Floor (FCR)					

Coefficient of Utilization (CU) from Manufacturer Data: _____

Light Loss Factors			
Nonrecoverable		Recoverable	
Luminaire ambient temperature		Room surface dirt depreciation	
Voltage to luminaire		Lamp lumen depreciation	
Ballast Factor		Lamp burnout factor	
Luminaire surface depreciation		Luminaire dirt depreciation	

Total light loss factor LLF (product of above factors): _____

Average Maintained Illuminance Calculations

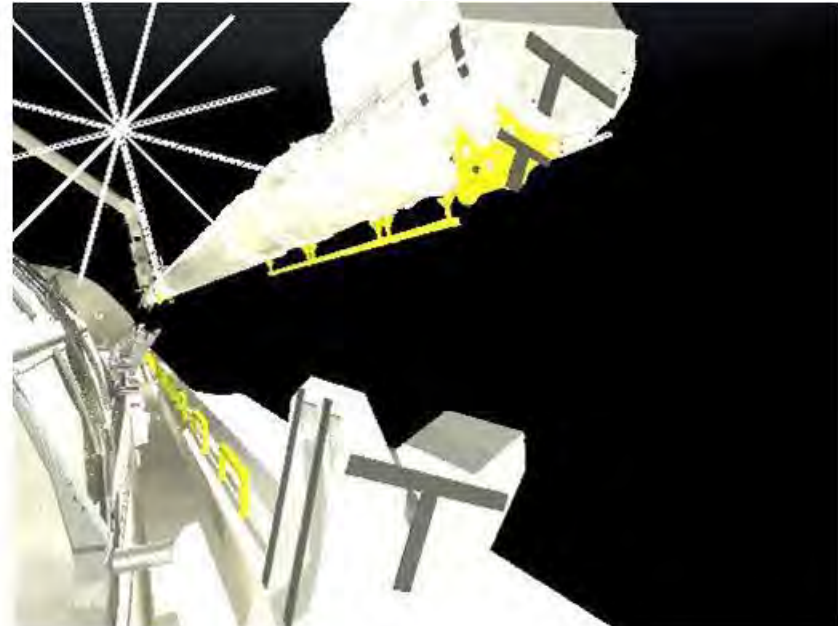
Figure 8.7-21 Zonal cavity method average illuminance worksheet.

8.7.11.8.2 Software-Assisted Lighting and Graphical Analysis

Lighting calculations can be complicated due to the multiple interacting surfaces that light can reflect off of in an environment. Once a general lighting concept is established, it is best to run the lighting design through graphical lighting analysis software. Software packages designed for lighting analysis typically allow for physical modeling of the environment, including material reflectance characteristics. These software packages often use lighting data, produced by lighting manufacturers, that is formatted into a configuration file called an “IES data file.” An “IES data file” is a configuration file that lists beam pattern data taken by the manufacturer of a specific luminaire. Some software packages use ray tracing and physics formulas to perform the calculations, whereas others use standard illumination engineering society lighting evaluation processes like the Lumen Method to calculate light at a surface. Most of these software packages can calculate illuminance and luminance at targeted areas. As with any modeling software, the more modeling inputted into the calculations, the more realistic the imaging. Some of the figures shown in sections 8.7.2.5.1 and 8.7.4.1 are computer-generated images from lighting analysis software that use the Lumen Method and inverse square law to perform calculations to generate a surface illuminance map. Although these images do not show a graphical representation of what a camera or person would see in the field of view, the images do show illuminance levels that could be used to evaluate whether a lighting situation is adequate. Figure 8.7-22 shows images generated by a software package called Radiance, which uses CAD models, physics, and monitor color conversion equations to show what a physical lighting environment looks like to the observer (Graphics Research and Analysis Facility, Johnson Space Center). These images show the same field of view but with different lighting conditions. These images are showing how glare affects the dynamic orbital lighting environment.



View from Camera C at Dawn +40 minutes, beta angle of 0 degrees, and the OBSS 6 inches away from the berthed position. The lighting is uniform. Image Saturation: 0.00%; Average Luminance: 35 fL. This view is typical for the middle of a day pass for all betas.



View from Camera C at Dawn +1 minute, beta angle of 0 degrees, and the OBSS 20 inches away from the berthed position. The sun is in the FOV of the camera from 4 to 11 minutes with beta angles between 0 and 30 degrees. The sun is in the FOV longer as the beta angle increases.

Figure 8.7-22 Radiance image showing glare in the orbital lighting environment.

The process of performing graphical analysis and detailed lighting calculations is a specialization and best performed by experts with experience in working with reflectance data, computer modeling, and lighting specifications.

8.7.12 Research Needs

More research needs to be performed in the following areas:

- System integration between luminaire designers, luminaire placement, and system architects to develop integrated requirements for light levels, color, and reflectance properties.
- Integrated system design optimized for mesopic vision to encourage the development of lightweight, low-power, low-cost system lighting solutions that can be used in extreme, hazardous, or emergency situations.
- Development of light-level requirements that account for older astronauts or astronauts whose vision may have been impaired due to intercranial pressure due to long-duration spaceflight.

8.8 REFERENCES

- Albyn, K. (1999). Passive Contamination Monitor - Alpha Magnetic Spectrometer and ESCA Analysis of Witness Plates, ISS/Attached Payloads External Contamination Technical Interchange Meeting May 6, 1999.
- American Bureau of Shipping. (2001). *Guide for Crew Habitability on Ships*. Houston, TX.
- Beaubien, J.M., & Baker, D. P. (2002). A review of selected aviation Human Factors taxonomies, accident/incident reporting systems, and data reporting tools. *International Journal of Applied Aviation Studies*, 2(2), 11-36.
- Blome, J.C. & Upton, B. E. (1967). Gemini window contamination due to outgassing of silicones. *Science of Advanced Materials and Process Engineering Series*, Vol. 11, Western Periodicals Co., 1967, 217-225.
- Boyce, P.R. (2003). *Human Factors in Lighting*. Taylor & Francis, New York.
- Brainard, G.C., Hanifin, J.P., Greeson, J.M., et al. (2001). Action spectrum for melatonin regulation in humans: evidence for a novel circadian photoreceptor. *Journal of Neuroscience*, 21(16): 6405-6412.
- Celentano, J.T., Amorelli, D., & Freeman, G.G. (1963, May 2, 1963). Establishing a Habitability Index for Space Stations and Planetary Bases. Paper presented at the AIAA/ASMA Manned Space Laboratory Conference, Los Angeles, CA.
- Commission Internationale de L'Éclairage. (1995b). *Discomfort Glare in Interior Lighting*, CIE Publication 117, Vienna, CIE.
- Commission Internationale de L'Éclairage. (2006). *Proceedings of the 2nd Expert Symposium on Light and Health*. CIE, Vienna, x031: pp 1-230.
- Connors, M.M., Harrison, A.A., & Atkins, F.R. (1985). Living Aloft: Human Requirements for Extended Spaceflight. (NASA-SP-483). Retrieved from <https://www2.sti.nasa.gov/Webtop/ws/asdb/ul/web/ImageDisplay/1985024459.pdf?&docid=1985024459&type=pdf&daa=>.
- Corballis, M.C., Zbrodoff, N.J., Shetzer, L.I., & Butler, P.B. (1978) Decisions about identity and orientation of rotated letters and digits. *Memory and Cognition* 6:98–107.
- Figueiro, M.G., Bullough, J.D., Bierman, A., & Rea, M.S. (2005). Demonstration of additivity failure in human circadian phototransduction. *Neuroendocrinology Letters* 26(5):493-498.
- Figueiro, M.G., Bullough, J.D., Parsons, R.H., & Rea, M.S. (2003). Preliminary evidence for spectral opponency in the suppression of melatonin by light in humans. *NeuroReport* 15:313-316.
- Fraser, T.M. (1968). *The Intangibles of Habitability During Long Duration Space Missions*. (NASA CR-1084). Washington, D.C.: Retrieved from http://ntrs.nasa.gov/archive/nasa/casi.ntrs.nasa.gov/19680017230_1968017230.pdf.
- Harrison, A.A., & Connors, M.M. (1990). Human factors in spacecraft design. *Journal of Spacecraft and Rockets*, 27(5), 478-481.

- Heineman, W. (1994). *Design mass properties II: Mass estimating and forecasting for aerospace vehicles based on historical data* (JSC 26098). Houston, TX. NASA JSC.
- Heinisch, R.P. (1971). *Light scatter from contaminated spacecraft windows* (No. 71-472). Washington, DC.
- Illuminating Engineering Society of North America (IESNA). (2000). *The IESNA lighting handbook*. Illuminating Engineering Society of North America, NY.
- Koontz, K.L., Mikatarian, R., Schmidl, D., Alfred, J., Smith, K., & ISS Subsystem Environments Team (2005). *STS-114 DTO-848 Non-Oxide Adhesive Experiment (NOAX) contamination (internal & external) risk assessment (SORR)*. April 22, 2005. Houston, TX. NASA JSC.
- Lane, H.W., & Feedback, D.L. (2002). Habitability and Environmental Factors: The Future of Closed-Environment Tests. In H. W. Lane, R. L. Sauer & D. L. Feedback (Eds.), *Isolation: NASA Experiments in Closed-Environment Living* (pp. 419-432). San Diego, CA: American Astronautical Society.
- Lee C, Porter K.M. Suspension trauma. *Emerg Med J*. 2007 Apr;24(4):237-8.
- Leger, L.J. & Bricker, R.W. (1972). *Apollo Experience Report - Window Contamination* (NASA TN D-6721). Houston, TX.
- Lindgren K, Mathes, K, Scheuring, R, et al. The Skylab Medical Operations Project: Recommendations to Improve Crew Health and Performance for Future Exploration Missions. NASA/TM-2009-214790, August 2009.
- Nicogossian, A.E. Mohler, S.R., & Gzenko, O.G. (1994). *Space Biology and Medicine Vol. 2*, American Institute of Aeronautics and Astronautics, Inc., Washington, DC.
- Novak, J. B. (2000). Human engineering and habitability: the critical challenges for the International Space Station. *Aviat Space Environ Med*, 71(9 Suppl), A117-121.
- Orzech MA, Goodwin MD, Brinkley JW, et al. Test Program to Evaluate Human Response to Prolonged Motionless Suspension in Three Types of Fall Protection Harnesses. Ohio, USA: Harry G Armstrong Aerospace Medical Research Laboratory, September 1987, AAMRL-TR-87-055, AD-A262 508. Available at: <http://handle.dtic.mil/100.2/ADA262508>.
- OSHA Safety and Health information Bulletin: Suspension Trauma/Orthostatic Intolerance. SHIB 03-24-2004. Available at <http://www.osha.gov/dts/shib/shib032404.html>.
- Roeggla M, Brunner M, Michalek A, et al. Cardiorespiratory response to free suspension simulating the situation between fall and rescue in a rock climbing accident. *Wilderness Environ Med*. 1996 May;7(2):109-14
- Roggla G, Moser B, Roggla M. Re: Suspension trauma. *Emerg Med J*. 2008 Jan;25(1):59.
- Runco, M., Eppler, D.B., Scott, K.P., & Runco, S.K. (2003). Earth science and remote sensing from the International Space Station utilizing the Destiny Laboratory's Science Window and the Window Observational Research Facility (WORF). Presented at: 30th International Symposium on Remote Sensing of Environment (ISRSE), Honolulu, Hawaii, November 10, 2003.
- Runco, M., Jr. (1999). JSC-STIC-VITO Window Testing Report, JSC Scientific and Technical Information Center-Vehicle Integration and Test Office Window Testing Report (Pilkington), 26 February 1999. Houston, TX. NASA JSC.

- Runco, M., Jr. (2005). U.S. Lab window operational constraints. ISS Generic Operational Flight Rules Volume B, Section B2-19, Final. Houston, TX. NASA JSC.
- Sanders, M., & McCormick, E. (1993). *Human Factors in Engineering and Design* (7th ed.). New York: McGraw-Hill, Inc.
- Scott, K.P., Brownlow, L.W., & Runco, M. et al. (2003). International Space Station Cupola Scratch Pane Window Optical Test Results. ATR-2003(7828)-1 (Aerospace Corporation) January 17, 2003.
- Scott, K.P. (1996). Analysis of external contamination on the ISS. Aerospace SSPO 96(7434)-55. September 1996.
- Scott, K.P., et al. (1999). ISS Window Observational Research Facility dynamic stability analysis. ATM No. 99(2110)-1 (Aerospace Corporation). October 31, 1999.
- Scott, K.P., et al. (1997). Test and analysis of Russian and U.S. materials utilized on ISS. ATR-97(7434)-49 (Aerospace Corporation). September 1997.
- Seddon P. Harness suspension: review and evaluation of existing information. Contract Research Report 451/2002 prepared for the British Health and Safety Executive. Available at: www.hse.gov.uk.
- Simon, M., Whitmire, A., Otto, C., & Neubek, D. (2011). *Factors Impacting Habitable Volume Requirements: Results from the 2011 Habitable Volume Workshop*. (NASA/TM-2011-217352). Space Shuttle Program. (2004). Location Coding Workbook. (JSC 26419) Houston, TX. NASA JSC.
- Stuster, J. (1996). *Bold Endeavors*. Annapolis, Md.: Naval Institute Press.
- Stuster, J. (2000). *Bold Endeavors: Behavioral Lessons from Polar and Space Exploration*. *Gravit Space Biol Bull*, 13(2), 49-57.
- Stuster, J. (2010). *Behavioral Issues Associated with Long-Duration Space Expeditions: Review and Analysis of Astronaut Journals Experiment 01-E104 (Journals): Final Report*. (NASA/TM-2010-216130). Houston, TX.
- Turner N.L., Wassell J.T., Whisler R., et al. Suspension tolerance in a full-body safety harness, and a prototype harness accessory. *J Occup Environ Hyg*. 2008 Apr;5(4):227-31.
- United States Congress. (1991). Office of Technology Assessment: Biological Rhythms: Implications for the Worker, # OTA-BA-463, pp. 1-249.
- Werntz C.L. III. Workers at height are required to use fall prevention systems. What are the health risks from being suspended in a harness? *J Occup Environ Med*. 2008 Jul;50(7):858-9.
- Wheelwright, C.D. (1973). *Apollo experience report – crew station integration, Volume V – Lighting considerations* (NASA Technical Note D-7290). Houston, TX. NASA JSC.
- Whitmore, M., Adolf, J.A., & Woolford, B.J. (2000). Habitability research priorities for the International Space Station and beyond. *Aviat Space Environ Med*, 71(9 Suppl), A122-125.
- Whitmore, M., McQuilkin, M.L., & Woolford, B.J. (1998). Habitability and performance issues for long duration space flights. *Hum Perf Extrem Environ*, 3(1), 64-74.

TABLE of CONTENTS

9	HARDWARE AND EQUIPMENT	802
9.1	INTRODUCTION	802
9.2	GENERAL HARDWARE AND EQUIPMENT DESIGN.....	802
9.2.1	Introduction	802
9.2.2	General Hardware and Equipment Design Guidelines	802
9.2.3	Hardware and Equipment Mounting	803
9.2.4	Alignment.....	804
9.2.5	Research Needs	805
9.3	MAINTAINABILITY	806
9.3.1	Introduction	806
9.3.2	Preventive and Corrective Maintenance	806
9.3.3	Accessibility	807
9.3.3.1	Physical Access	807
9.3.3.2	Visual Access	809
9.3.4	Failure Notification	810
9.3.5	Efficiency	810
9.3.6	Tools and Fasteners.....	810
9.3.7	Circuit Protection	811
9.3.8	Fluids.....	811
9.3.9	Research Needs	811
9.4	TOOLS.....	812
9.4.1	Introduction	812
9.4.2	Tool Selection	812
9.4.3	Power Tools.....	812
9.4.4	Tool Features	813
9.4.5	Tool Packaging and Stowage	814
9.4.6	Tool Labeling and Identification.....	817
9.4.7	Tool Access.....	818
9.4.8	Research Needs	820
9.5	DRAWERS AND RACKS.....	821
9.5.1	Introduction	821
9.5.2	General Drawer and Rack Features.....	821
9.5.3	Stowage Drawers.....	822
9.5.4	Equipment Drawers.....	822
9.5.5	Research Needs	822
9.6	CONNECTORS.....	823
9.6.1	Introduction	823
9.6.2	General Connectors	823
9.6.3	Fluid and Gas Connectors	823
9.6.4	Electrical Connectors	824
9.6.5	Structural Connectors.....	824
9.6.6	Connector Arrangement	824
9.6.7	Research Needs	827
9.7	RESTRAINTS AND MOBILITY AIDS.....	828

9.7.1	Introduction	828
9.7.2	Mobility Aids	828
9.7.2.1	General Mobility Aid Design	828
9.7.2.2	Personal Mobility Aids.....	829
9.7.2.2.1	Mobility Aid Shape and Dimensions	830
9.7.2.2.2	Coding.....	830
9.7.2.2.3	Finish.....	831
9.7.2.2.4	Design Loads.....	831
9.7.2.2.5	Mounting.....	831
9.7.2.3	Equipment Mobility Aids.....	831
9.7.2.3.1	Handle and Grasp Areas.....	832
9.7.2.3.2	Handle Shape and Dimensions.....	832
9.7.2.3.3	Nonfixed Handles.....	834
9.7.3	Restraints.....	834
9.7.3.1	Personnel Restraints	834
9.7.3.1.1	Foot Restraints.....	836
9.7.3.1.2	Body Restraints	838
9.7.3.1.2.1	Body Restraint Loads	838
9.7.3.1.2.2	Body Restraint Dimensions.....	839
9.7.3.1.3	Sleep Restraints	839
9.7.3.2	Equipment Restraints	840
9.7.3.2.1	General Equipment Restraint Design	840
9.7.3.2.2	Specific Restraint Systems	841
9.7.3.2.3	Tethers.....	841
9.7.3.2.4	Loads	842
9.7.3.2.5	Example Equipment Restraints	842
9.7.3.2.6	Unique Equipment Restraints.....	845
9.7.4	Research Needs	847
9.8	CABLES.....	848
9.8.1	Introduction	848
9.8.2	Cable Design and Routing	848
9.8.3	Cable Identification	849
9.8.4	Research Needs	850
9.9	CREW PERSONAL EQUIPMENT	851
9.9.1	Introduction	851
9.9.2	General Considerations	851
9.9.3	Research Needs	852
9.10	CLOSURES AND COVERS.....	853
9.10.1	Introduction	853
9.10.2	General Considerations	853
9.10.3	Research Needs	854
9.11	FASTENERS	855
9.11.1	Introduction	855
9.11.2	General Fasteners	855
9.11.2.1	Hand-Actuated Fasteners	856
9.11.2.2	Tool-Actuated Fasteners	859

9.11.3	Packaging	860
9.11.3.1	Packaging Design	860
9.11.4	Research Needs	861
9.12	SAFETY HAZARDS.....	862
9.12.1	Introduction	862
9.12.2	Mechanical Hazards	862
9.12.2.1	Sharp Edges.....	862
9.12.2.2	Loose Equipment.....	863
9.12.2.3	Entrapment	864
9.12.2.4	Burrs.....	864
9.12.2.5	Pinch Points.....	864
9.12.3	Thermal Hazards	864
9.12.3.1	High Temperature.....	864
9.12.3.2	Low Temperatures.....	869
9.12.4	Electrical Hazards	871
9.12.4.1	Methods of Reducing Risk of Shock.....	872
9.12.4.2	Effects of Electrical Shock	873
9.12.4.3	Examples of How to Use IEC TR 60479-5 for Electrical Safety Analysis.....	874
9.12.4.4	Estimating Human Body Impedance.....	875
9.12.4.5	Measurement Methods	876
9.12.4.6	Definitions.....	877
9.12.5	Research Needs	877
9.13	DESIGN FOR TRAINING.....	879
9.13.1	Introduction	879
9.13.2	Design with Training in Mind.....	879
9.13.3	Methods for Integrating Training into Design	880
9.13.3.1	Analyze the Task and Intended User.....	880
9.13.3.2	User Knowledge and Knowledge Transfer.....	881
9.13.3.3	Consistency and Standardization.....	881
9.13.3.4	Similarity versus Differentiation	882
9.13.3.5	Ease of Learning versus Ease of Use	882
9.13.3.6	Automation.....	882
9.13.3.7	Adaptive Systems and Embedded Training	883
9.13.3.8	Performance Support Systems	883
9.13.3.9	Optimal Training.....	883
9.13.4	Research Needs	884
9.14	REFERENCES.....	885

TABLE of FIGURES

Figure 9.2-1	Alignment marks.	804
Figure 9.2-2	Connector keying	805
Figure 9.3-1	Minimum sizes for access openings for two hands, one hand, and fingers without visual access. (MIL-STD-1472F).....	809
Figure 9.4-1	Shuttle hand tool stowage. (JSC-12770, 1985)	815
Figure 9.4-2	Shuttle tool stowage. (JSC-12770, 1985)	816
Figure 9.4-3	Shuttle tool translation and retention pouch. (JSC-12770, 1985)	817
Figure 9.4-4	Tool access requirements. (IVA) (GIAG-3, 1986).....	819
Figure 9.4-5	IVA tool head clearance	819
Figure 9.4-6	Minimal clearance for tool-operated fasteners. (MSFC-STD-512A, 1976).....	820
Figure 9.6-1	Preferred spacing of single row of connectors (bare or gloved hand). (MSFC-STD-512A, 1976).....	825
Figure 9.6-2	Preferred spacing of staggered single rows of connectors. (MSFC- STD-512A, 1976)	825
Figure 9.6-3	Color and alphanumeric coding of mating connectors. (MIL- HDBK-759A, 1981)	826
Figure 9.6-4	Electrical connector keys. (AFSC DH 1-3, 1972).....	827
Figure 9.6-5	Arrangement of guide pins. (AFSC HD 1-3, 1972).....	827
Figure 9.6-6	Alignment marks. (AFSC HD 1-3, 1972).....	827
Figure 9.7-1	Removable ISS handrail	829
Figure 9.7-2	IVA handhold cross section. (MSFC-STD-512A, 1976).....	830
Figure 9.7-3	IVA handhold dimensions. (MSFC-STD-512A, 1976).....	830
Figure 9.7-4	Minimum IVA handle dimensions. (MIL-STD-1472F, 1981)	833
Figure 9.7-5	Minimum IVA handle dimensions for curvature. (MIL-STD- 1472F, 1981).....	833
Figure 9.7-6	Example of lower leg restraint on Skylab. (MSFC-STD-512, 1974)	837
Figure 9.7-7.	ISS short-duration foot restraint (attaching to an ISS handrail).	838
Figure 9.7-8.	ISS long-duration foot restraint (attached to workstation seat track).....	838
Figure 9.7-9	ISS long-duration crewmember restraint.....	838
Figure 9.7-10	Shuttle sleep restraint. (JSC-12770, 1985)	840
Figure 9.7-11	Examples of equipment restraints. (JSC 12770, 1985)	844
Figure 9.7-12	ISS cable restraint.....	844
Figure 9.7-13	Quick twist wire-mount assembly	845
Figure 9.7-14	ISS 8-in. bundling wrap assembly	845
Figure 9.7-15	Russian flat bungees (left), U.S. large adjustable round bungee (right).....	845
Figure 9.7-16	Flexible bracket.	846
Figure 9.6-17	Multiuse bracket.	846
Figure 9.7-18	Payload equipment restraint system.	847
Figure 9.8-1	Cable identification technique. (AFSC HD 1-3, 1972)	849
Figure 9.8-2	Spare or test cable identification methods. (JSC-18702, 1985)	850
Figure 9.10-1	Example of use of closures. (MSFC-STD-512A, 1976).....	854

Figure 9.11-1 Hand torque capabilities when restrained by both feet, both feet and pelvis, or both feet and one hand (IVA). (MSFC-STD-512A, 1976).....	858
Figure 9.11-2 Hand torque capabilities when restrained by one hand (IVA). (MSFC-STD-512A, 1976)	858
Figure 9.11-3 Torque by knob size (values for 5th-percentile male). (MSFC-STD-512A, 1976)	859
Figure 9.12-1 Hot T_{PM} for incidental and intentional (planned) contact.....	868
Figure 9.12-2 Cold T_{PM} for incidental and intentional (planned) contact.....	871
Figure 9.12-3 Internal human body resistance model.....	876
Figure 9.12-4 Typical measuring circuit.....	877

TABLE of TABLES

Table 9.7-1 Personnel Restraints Used on Skylab and ISS (MSFC-STD-512, 1974; OpsHab, 2001).....	834
Table 9.12-1 Corners and Edges	862
Table 9.12-2 Loose Equipment Corners and Edges	863
Table 9.12-3 Inverse Thermal Inertia for Commonly Used Materials	867
Table 9.12-4 Hot Temperature Constants for Intentional Contact	867
Table 9.12-5 Cold Temperature Constants for Incidental Contact	870
Table 9.12-6 Cold Temperature Constants for Intentional Contact	870
Table 9.12-7 Physiological Effects of Electric Shock (60 Hz)	873

9 HARDWARE AND EQUIPMENT

9.1 INTRODUCTION

This chapter provides human factors data applicable to all hardware and equipment. Additional data that is specific to certain hardware or equipment is included in sections on tools, drawers and racks, connectors, mobility aids, restraints, handles and grasp areas, clothing, cables, and crew personal equipment. Features for managing hardware and equipment such as closures, covers, fasteners, and packaging are also discussed. The data contained within this section applies to hardware and equipment for both intravehicular activity (IVA) and extravehicular activity (EVA). Additional data specifically addressing EVA is located in Chapter 11, EVA.

9.2 GENERAL HARDWARE AND EQUIPMENT DESIGN

9.2.1 Introduction

This section discusses the general human factors principles that need to be applied to hardware and equipment design to enhance crew performance, safety, and comfort during operations. The guidance in this section should be applied across all hardware and equipment.

9.2.2 General Hardware and Equipment Design Guidelines

Hardware and equipment design should consider and integrate human interface features required for the item's intended operation and functionality. These features should be considered when developing requirements for hardware and equipment. Early incorporation of human factors data and relevant human operational experience will optimize design and increase operational effectiveness.

General human factors principles need to be applied to design of hardware and equipment to enhance crew performance, safety, and comfort during operations. When designing hardware and equipment, consider the following:

- Safe – designs must provide for safe and efficient use, manipulation, and handling.
- Durable and Reliable – designs must be capable of withstanding the forces imposed intentionally and unintentionally by crewmembers, and capable of sustaining operations for extended durations with minimal maintenance.
 - As an example, the ISS food warmer, which uses a basic buckle mechanism, was identified as beginning to fail from nominal use. The loss of the food warmer was deemed critical by the crew. (OpsHab, 2008)
- Standardized – hardware and equipment with similar functions must have standardized and consistent design.
- Accommodation – hardware and equipment must be accessible and usable by the full anthropometric, range of motion, and strength ranges of the crew. (see Chapter 4, Anthropometry, Biomechanics & Strength)
- Identifiable – hardware and equipment should be easily identifiable. Where it is not obvious, labeling should be used.

- Minimal Training – hardware and equipment must be designed to minimize the time required for training
- Similar Form – hardware and equipment that have the same or similar form but different functions must be readily identifiable, distinguishable, and not be physically interchangeable.

To ensure hardware availability and contribution to mission success, an early and judicious assessment of supportability and maintainability of hardware design needs to be considered. Feedback from the ISS crews has indicated that in general, ISS hardware supportability, specifically maintainability, may not have been a priority or well integrated into design. The need for hand tools for most if not all maintenance tasks on the U.S. segment of the ISS was thought to be excessive (OpsHab, 2008).

9.2.3 Hardware and Equipment Mounting

Improperly mounted hardware and equipment can result in unsafe conditions for crewmembers and may cause damage to hardware. When mounting hardware and equipment, the following guidance applies:

- Equipment Mounting – Equipment items must be designed so that they cannot be mounted improperly, and include physical features, labeling, or marking.
- Drawers and Hinged Panels – Subsystem components that are frequently removed from their installed position for checkout should be mounted on equipment drawers or on hinged panels.
- Layout – Components should be mounted so that a minimum number of place-to-place hand movements would be needed during operations.
- Covers or Panels – Expected replaceable items should have a minimum number of covers or panels.
- Force Required for Installation and Removal – Hardware mounting must not require forces greater than the strength capabilities of the crew.
- Rear Access – Equipment to which rear access is necessary should be free to open or rotate to its full distance of travel and remain in the open position.
- Tools – When possible, common tools should be used.
- Direction of Removal – Replaceable items should be removable along a straight or slightly curved line.
- Visibility – Visual access for alignment and attachment of equipment must be provided and blind access to fasteners should be avoided.
- Spacing – Mounting bolts and fasteners should be spaced far enough from other surfaces to allow personnel to manipulate them.
- Number of Fasteners – The minimum number of fasteners should be used, consistent with stress and vibration requirements, so that the crewmembers' workload is minimized.
- Captive Fasteners – Fasteners used by the crew during maintenance must be captive to help reduce crew workload, handling, stowage, and to prevent loss.

9.2.4 Alignment

Proper alignment of equipment to mounting surfaces and connectors to receptacles is important to ensure safety and proper function. Improper mating or misalignment of connectors can lead to short-circuit or open-circuit conditions that can reduce the safety of flight and ground crews and may cause damage to hardware.

When designing the alignment for replaceable hardware, consider the following:

- Alignment Marks – If proper interface orientation is not obvious by virtue of external geometry or if adequate visibility cannot be provided for hardware that will be mounted during operations, the hardware design should incorporate alignment marks and/or orientation arrows (Figure 9.2-1).
 - Alignment marks should be applied to both mating parts and the marks should align when the parts are in the operational position.
 - An alignment mark should consist of a straight line of a width and length appropriate to the size of the item.
 - Alignment marks should be clearly visible to a crewmember performing hardware removal or replacement.

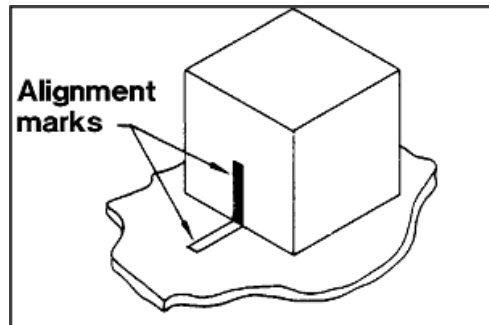


Figure 9.2-1 Alignment marks.

- Alignment Devices – Guide pins or their equivalent should be provided to assist in alignment of hardware during mounting, particularly on modules that have integrated connectors.
- Keying – Mechanical keys should be considered where misconnections may result in mismating or cross-connecting (incorrect connections with other accessible connectors, plugs, or receptacles) (Figure 9.2-2).

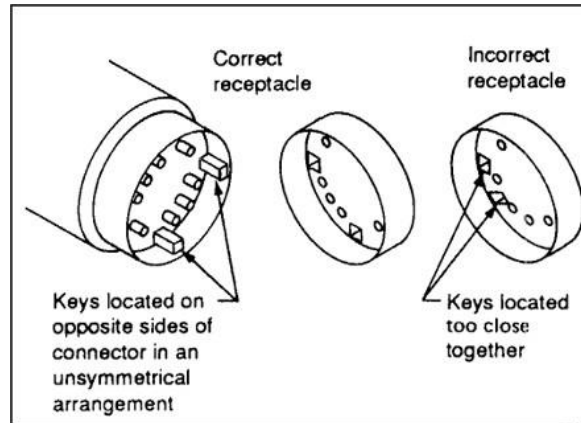


Figure 9.2-2 Connector keying.

- Labeling – Unique labeling of equipment should be used to indicate that the equipment to be mounted and the mounting location match, and to indicate the proper alignment and the correct use of attaching parts.

9.2.5 Research Needs

RESERVED

9.3 MAINTAINABILITY

9.3.1 Introduction

The design of equipment and systems greatly affects how they are maintained, in terms of complexity, duration, frequency, and safety. This section contains guidance for designing equipment and systems to facilitate maintenance and ensure proper maintainability.

Goals of designing for maintainability include:

- Reduce the need for specialized skills, tools, and training
- Reduce crew time spent on preventive and corrective maintenance
- Reduce crew cognitive workload
- Ensure crew safety during maintenance tasks

9.3.2 Preventive and Corrective Maintenance

Maintainability should be considered an integral part of hardware design and a life-cycle systems engineering approach, from the earliest design phases throughout flight operations. Much of the ISS equipment was designed before a complete operational plan was available for how it would be used, which led to designs that are difficult to access for repairs and maintenance (access panels), and hardware and systems that are not durable and maintainable. For some missions with ready access to ground support, tasks can be allocated among crew, ground personnel, and automated systems. However, for some long-duration planetary missions that are envisioned, the probability of delays and lack of available communication with ground mission control necessitates more autonomous operation. Two key aspects of designing for maintainability include 1) preventive maintenance and 2) corrective maintenance. For an automobile, preventive maintenance includes tasks that aim to prevent system failures, such as periodically changing the oil to reduce wear on the engine; corrective maintenance includes tasks that need to be completed to restore a failed system to proper working order, such as changing a flat tire.

When designing for corrective and preventive maintenance, consider the following:

- Preventive maintenance must be minimized and require as little crew time as feasible.
- Preventive maintenance schedules should be sufficiently flexible to accommodate changes in the schedule of other mission activities.
- If maintenance is necessary and system operations will be interrupted, redundant installations should be considered to permit maintenance without interrupting system operation.
- Maintenance plans for commercial off-the-shelf (COTS) equipment must be appropriate to the space environment, and not simply what is in the recommended ground-based factory standard maintenance plan.
- Automated fault detection and isolation should be provided.
- Calibration, alignment, or adjustment should be easily and accurately accomplished.

9.3.3 Accessibility

Inspecting, removing, and replacing equipment may need to be done during any phase of flight, in which the spacecraft may be in different gravity conditions, and by individuals wearing protective clothing and equipment that may limit mobility. Examples of protective clothing and equipment are flight suits, Self-Contained Atmosphere Protective Ensemble (SCAPE) suits, and even EVA suits. Equipment includes everything that is planned to be maintained in flight, from a complete unit down to a component level. Components may include computer cards, power supplies, or individual electronic components. Equipment should be designed so that the elements to be maintained are not only visible, but physically accessible.

9.3.3.1 Physical Access

Adequate access and working space is needed to allow personnel to efficiently access equipment in a way that minimizes the potential for human error or system damage. Many maintenance activities onboard the ISS have required physical access behind panels or racks. Crew interfaces with systems and associated hardware should provide crewmembers with the work envelope to perform the expected maintenance activities, and designers of these interfaces need to consider that crewmembers may be wearing protective clothing when appropriate, and the size and use of tools and test equipment.

When designing for physical access consider the following:

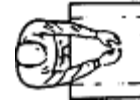
- **Priority of Access** – Items that are most critical to system operation and require rapid maintenance must be most accessible. When relative criticality is not a factor, items requiring most frequent access must be most accessible. Easy access must be provided for components that fail frequently (e.g., lamps and fuses).
- **Access Dimensions** – Access openings for two hands, one hand, and fingers should accommodate the dimensions shown in Figure 9.3-1. In the case where access to openings is required by a suited crewmember, the suit glove dimensions, tactility and dexterity characteristics should be considered.
- **Component Removal** – Access to inspect or replace a component (e.g., an orbital replacement unit [ORU]) should not require removal of other component(s) that is not the subject of the maintenance activity.
- **Access Covers** – Access covers that are not completely removable should be self-supporting in the open position. Access to inspect or replace a component (e.g., an ORU) should not require removal of more than one access cover. Access covers should not require the removal of many fasteners and, if accessed frequently, should not require the use of a tool.
- **Check Points and Service Points** – Check points and service points for systems must be in accessible locations. To protect the crew and ground personnel, access points should not be located near electrical, mechanical, or other hazards, or provide other means of hazard protection.
- **Cables** – Cables should be routed to be accessible for inspection and repair. Cables should have sufficient slack for removal of connectors, unless adequate physical and visual access is provided.

Minimal two-hand access openings without visual access

Reaching with both hands to depth of 150 mm (5.0 in.) to 490 mm (19.25 in.):

Light clothing: Width: 200 mm (8.0 in.) or the depth of reach

Height: 125 mm (5.0 in.)



Reaching full arm's length (to shoulders) with both arms:

Light clothing: Width: 500 mm (8.0 in.) or the depth or reach

Height: 125 mm (5.0 in.)

Inserting box grasped by handles on the front:

13 mm (0.5 in.) clearance around box, assuming adequate clearance around handles



Inserting box with hands on the sides:

Light clothing: Width: Box plus 115 mm (4.5 in.)

±Height: 125 mm (5.0 in.) or 13 mm (0.5 in.) around box*



* Whichever is larger

± If hands curl around bottom, allow an extra 38 mm (1.5 in.) for light clothing.




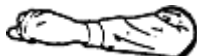



Minimal one-hand access openings without visual access		
Height x Width		
Empty hand, to wrist		
Bare hand, rolled	95 mm (3.75 in.) sq or dia	
Bare hand, flat	55 mm (2.25 in.) x 100 mm (4 in.) or 100 mm (4 in.) dia	
Clenched hand, to wrist		
Bare hand	95 mm (3.75 in.) x 125 mm (5.0 in.) or 125 mm (5.0 in.) dia	
Arm to elbow		
Light clothing	100 mm (4.0 in.) x 115 mm (4.5 in.)	
Arm to shoulder		
Light clothing	125 mm (5.0 in.) sq or dia	
Minimal finger access to first joint		
Push-button access		
Bare hand	32 mm dia (1.26 in.)	
Two-finger twist access		
Bare hand	object plus 50 mm (1.97 in.)	

Figure 9.3-1 Minimum sizes for access openings for two hands, one hand, and fingers without visual access. (MIL-STD-1472F)

9.3.3.2 Visual Access

In general, crew interfaces with systems and associated hardware should be visually accessible during planned maintenance activities. Direct line-of-sight visual access reduces the likelihood of human error that can occur when blind (by feel) operations or operations requiring the use of specialized tools (e.g., mirrors or bore scopes) are performed. Crew interfaces include items such

as connectors and fasteners. Direct line of sight for pin inspection is not necessary, although desired where possible. This does not apply to blind-mate connectors with guides, which are automatically de-mated and mated as a piece of equipment is removed and replaced.

When designing for visual access consider the following:

- Visual-Only Access – Where only visual access is required, the following practices should be followed with the order of preference as given:
 1. Provide an opening with no cover except where this might degrade system performance.
 2. Provide a transparent window if dirt, moisture, or other foreign materials might create a problem.
 3. Provide a quick-opening metal cover if a transparent cover will not meet other requirements.
- Visual and Manual Access – If a crewmember needs to see the equipment to perform a maintenance task, the access must be large enough to allow simultaneous visual as well as physical access; otherwise a separate window should be provided for visual access to monitor task performance.
- Labeling – Each access should be labeled to indicate items visible or accessible through it, including a number, letter, or other symbol that is directly cross-referenced to maintenance procedures. Cables, fluid lines, and shields protecting other subsystems should also be labeled or otherwise coded to allow positive identification.

9.3.4 Failure Notification

Systems must alert the crew when flight-critical equipment has failed and when it is not operating within tolerance limits, without removal of that equipment. Automatic alerting of equipment failure expedites troubleshooting and ensures that the crew has adequate situational awareness of the functionality that has been lost.

9.3.5 Efficiency

Equipment design must minimize the amount of time required for maintenance. Crew time for mission activities during flight is in short supply. Preliminary studies based on ISS operations indicate that 2 person-hours per day of overhead activities is the maximum amount of time that can be allocated without incurring detrimental effects on primary mission activities.

ORUs should have a total maintenance time for removal and replacement of no more than 3 hours. Spaceflight experience and engineering judgment by subject matter experts indicate that most maintenance activities, including safing, access, removal, replacement, and closeout back to original hardware configuration, can be accomplished in 3 hours or less if the spacecraft is designed to facilitate maintenance.

9.3.6 Tools and Fasteners

Maintenance activities are primarily where tools and fasteners are used. The design and number of tools are important considerations to minimize crew training and in-flight operations. Since

many tools are used in conjunction with fasteners, the tool design depends greatly on fastener design. See sections 9.4 Tools, and 9.11 Fasteners, for more information.

9.3.7 Circuit Protection

Circuits are protected by devices such as fuses and circuit breakers. Fuses work by intentionally self-destructing in an overload situation and need to be replaced after use. Finding, sizing, and replacing fuses takes more time than resetting circuit breakers. Circuit breakers “trip,” can be reset by pushing them back into place, and do not require replacement and storage. During periods of flight when time is critical, circuit breakers are preferred since they return the circuit to normal functionality with a single task. Because of the logistics, storage, and time required for fuse replacement, circuit breakers should be used in preference to fuses.

To protect circuits during critical phases of flight, circuit breakers should be used, and should not require the removal or opening of access panels. Where circuits and fuses are used, their condition (good or blown) must be readily discernible. The determination of condition should not require the removal of a fuse.

9.3.8 Fluids

The leakage of fluids (liquid or gas) can be a hazard to crew health, and is especially hard to control during 0g operations. Additionally, leakage during any mission phase (flight or ground) can cause hazardous conditions and increase housekeeping tasks, and may damage equipment. Subsystems that contain liquids or high-pressure gases and require maintenance should be designed with fluid isolation features. Isolation features, such as valves and quick-disconnect couplings, allow more efficient system maintenance, permit isolation and servicing, aid in leak detection, and eliminate the need to drain and refill systems. Replaceable components must be designed to control the leakage of fluids during removal or replacement.

9.3.9 Research Needs

Access opening requirements are needed for two-handed and single-handed maintenance operations by a suited pressurized crewmember.

9.4 TOOLS

9.4.1 Introduction

This section discusses tools, both manual and power, for use during normal operations as well as for planned and unplanned or contingency maintenance activities. Launch, entry, and temporary tool stowage requirements should also be considered in final tool designs.

9.4.2 Tool Selection

The need for tools should be considered early in system design, since their use can have an impact on crew training and flight operations.

When determining the tool complement for space missions, consider the following:

- Standardization – Tools must be standardized. This includes a need for commonality of measurement system (English versus metric).
- Minimal Tool Set – The system should be maintainable and reconfigurable using a minimum set of tools that are as common as feasible with the other systems. A minimum set of tools, common to more than one system, allows many maintenance tasks to be performed without a proliferation of unique tools. Minimizing the tool set reduces training, operations, and support requirements for the system. A reduced variety of fasteners is an important consideration for reducing the number of tools needed.
- Multipurpose Tools – A tool kit should include multipurpose and multi-size tools, as there are often unexpected needs.

The ISS crewmembers have provided feedback on use of unique tools in their inventory:

- An upgraded soldering iron with the capability of determining its temperature is desired.
- The torque key wrench is a particularly useful tool.
- The strap wrench was difficult to use, and isn't intuitive.
- The fluid fitting torque device tool was noted as being difficult to use.
- There is a need for a workshop-type bench vise; seat clamps are inadequate and flimsy.
- The crew had problems with the scope-meter, preferring a compact, low-technology multimeter (OpsHab, 2008).

9.4.3 Power Tools

Power tools should be used to accomplish repetitive manual tasks, such as disengaging captive fasteners or operating mechanical drive systems. Use of power tools offers enormous returns in reduced crewmember time, effort, and ease of operation.

Power tools subject the crewmember to specific hazards and stresses that should be addressed. Specific considerations include

- Rotating components
- Electrical shock (see section 9.12 Safety Hazards)
- Heat generation

- Flying particles or sparks
- Inadvertent power activation
- Hazards to the non-operating hand

Power tool design should avoid the use of brush-type motors, since they may create hazardous electromagnetic interference and provide an ignition source.

The standard practice has been to accept many of the above hazards as part of the job and to place the burden of protection on users (e.g., wear eye protectors, use special electrical grounding devices, wear gloves, and taking other precautions). In many cases these are the only methods available to reduce the hazard potential. However, the designer needs to, in each new tool design, review such hazards and attempt to remove them whenever possible in the design. When this cannot be accomplished, the designer has the responsibility for providing appropriate warning labels on the tool and/or including properly worded warning instructional materials with the tool.

For rechargeable battery-powered tools, the inventory of spare power packs and the location of recharge stations are important design considerations:

- Power tools should be designed so the battery packs can be replaced at the worksite.
- Power tools using battery packs should have a level-of-charge indicator or an indication of when a battery pack is required to be replaced or recharged.
- Hazards associated with charging and stowage of rechargeable batteries (such as toxic or flammable off-gassing, leakage of corrosive electrolytes, or high temperatures) should be considered and controlled.
- Battery packs should always be ready for use and not involve special handling or maintenance.

9.4.4 Tool Features

Power and manual hand tools should be designed with the users, functions, and environment in mind.

When designing tools, consider the following:

- Handgrip Size and Shape
 - Gripping Surface – Hand grip surfaces should fit the bare hand and if it is to be used during EVA, then the grip surface should fit the EVA gloved hand. The hand grip surface should also minimize abrasion to EVA glove material.
 - Sleeve-Type Adapters – Adapters should adequately secure sleeve-type handle covers so they will not slip, rotate, or come off.
 - Orientation – Tool handle orientation should allow the operator’s wrist to remain in the most natural position while force or guidance inputs are applied.
- Auxiliary Controls – If an auxiliary control on the tool needs to be manipulated while the operator is holding the tool, the control should be located where
 - The thumb or finger of the holding hand can manipulate the control without disturbing the tool or fastener holding position.

- Unintentional or inadvertent control operation is impossible.
- Tool Handedness – Since the crew population will include both left- and right- handed crewmembers, tools need to be designed with this consideration to allow any crewmember to perform necessary tasks with the appropriate tool. Hand tools should be
 - Operable by one hand when possible.
 - Operable by either the left or right hand.
- Tool Actuation Forces and Direction of Action
 - Actuation Force – Tools must have an actuation force of less than the strength capabilities of the crew.
 - Throw Angles – Ratcheting tools should be capable of providing torque with a throw angle of 45° or less.
 - Plier-Type Tools – Plier-type tools should be spring-actuated in the open direction to permit one-handed operation.
- Tool Retention – A means should be provided on all tools for restraining the tool during use in 0g conditions.
 - Retention features (such as tethering) should not interfere with nominal operation of the tool.
- Inadvertent Tool Disassembly – A means should be provided to prevent inadvertent tool disassembly while installing, using, removing, or transporting the tool.

9.4.5 Tool Packaging and Stowage

Tool stowage should allow for ease of retrieval, retention, identification, and replacement. To accomplish this, consider the following:

- Stowage Location
 - Specialized tools should be stowed close to where they will be used.
 - General-purpose tools should be stowed in one specific area.
 - Stowage location of tool kits should be optimized for accessibility to workstations and/or maintenance workbenches.
- Tool Arrangement in Stowage Container – A systematic approach in the arrangement of tools in the tool kit should be applied. The ISS experience showed that foam cut-outs for tool retention needs to be sufficiently precise to adequately retain tools and not cause binding and sticking of the drawers (OpsHab, 2008). However, foam may not be the ideal solution for long-duration missions since it can break down and create particulates if it is not adequately contained.
- Tool Placement Labels – Placement labels should be provided for each tool in a stowage container.
 - It should be obvious if a tool is not in its storage location. For example, tool boxes that use different colors of foam, such as a yellow layer of foam beneath a blue layer. By providing the different colors of foam, it is easy to determine that a tool has not

been returned. Tools, unaccounted for, can become hazardous to hardware and personnel.

Figures 9.4-1 and 9.4-2 show examples of Space Shuttle IVA tool storage containers.

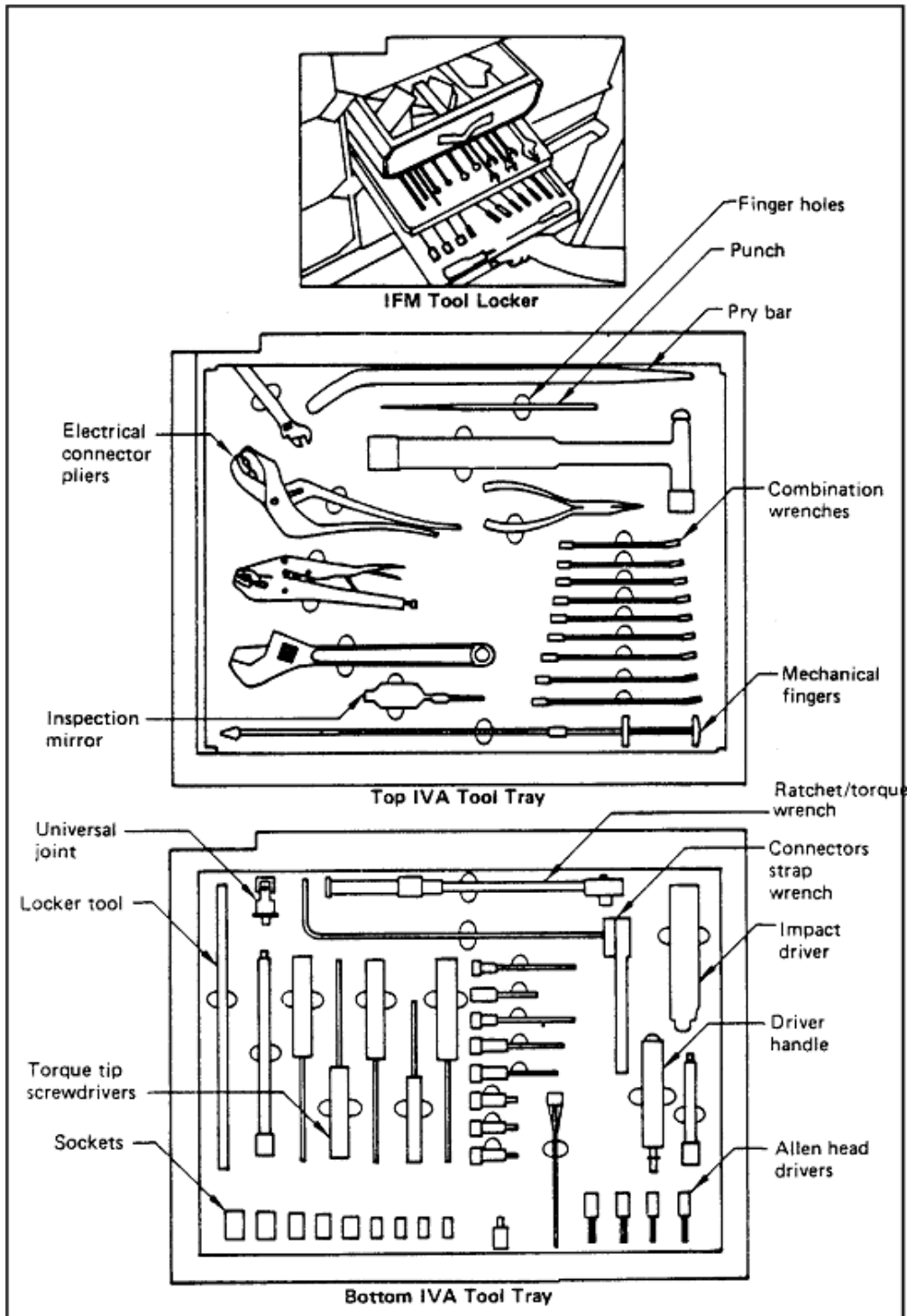


Figure 9.4-1 Shuttle hand tool storage. (JSC-12770, 1985)

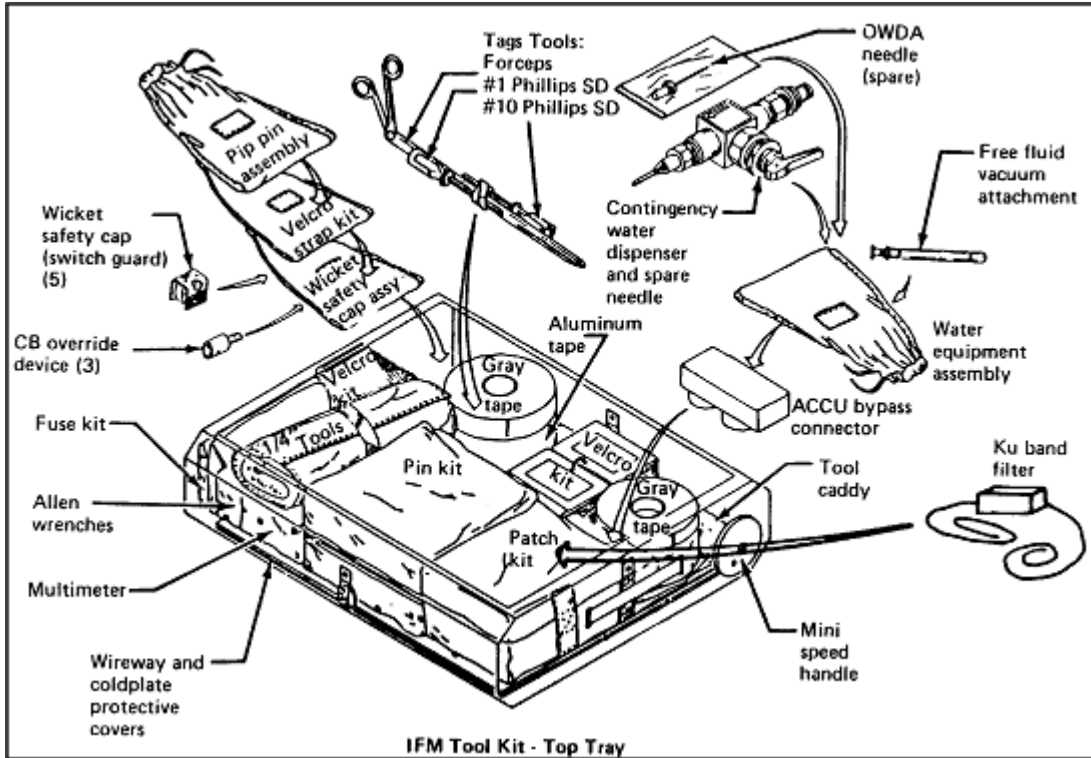


Figure 9.4-2 Shuttle tool stowage. (JSC-12770, 1985)

- Tool Carrier – A carrier should be provided for the transportation of tools from a stowage location to worksites. Design of the carrier must ensure that the tools remain restrained within the carrier in 0g conditions.
 - Tool Carrier Materials – Transparent carrier materials should be considered so that the tools can be seen without opening the carrier. Figure 9.4-3 shows a Space Shuttle tool carrier.
 - Retention of Small Parts – Tool carriers should provide a means of retaining small parts and attaching hardware. Items retainable in this manner should be visible for retrieval.
 - Tool Restraint During Translation – Tools should be restrained in the tool carrier with sufficient force to prohibit detachment during translation.
 - Tool Carrier Attachment – Tool carriers and tool retention devices should have provisions to attach the device to the crewmember or to adjacent structures or equipment. As an example, the ISS crews have indicated that the Payload Equipment Restraint Systems Tool Page was useful for locating tools close to the worksite. (OpsHab, 2008)

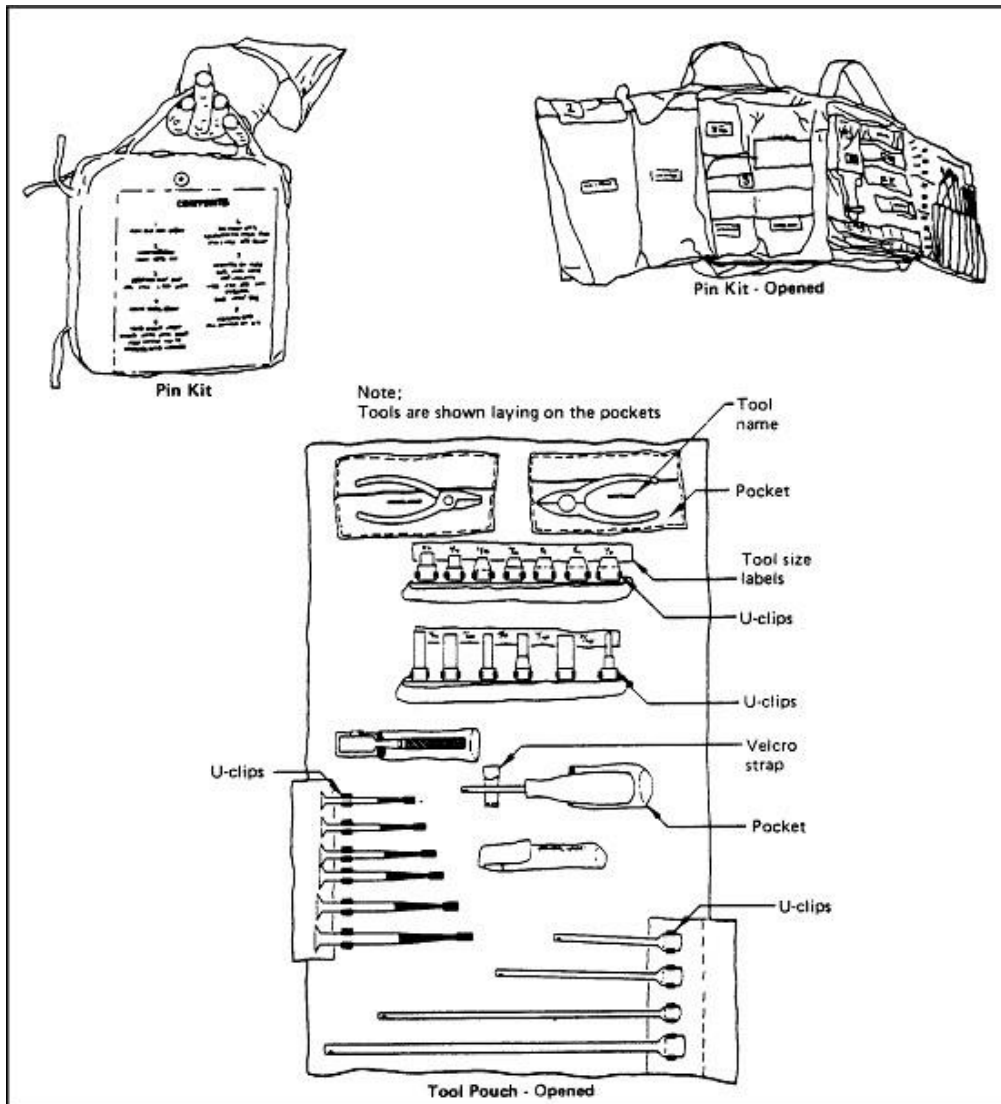


Figure 9.4-3 Shuttle tool translation and retention pouch. (JSC-12770, 1985)

9.4.6 Tool Labeling and Identification

Tool and tool stowage labeling and identification requirements must comply with the labeling guidance defined in section 10.11 Hardware Labels as well as the following:

- General Tool Names – Tool names used in procedures and inventory lists must be identical to the names on the tools and/or tool labels and, in all cases, will be the most common definitive name recognizable by the crewmembers.
- Specialized Tool Names – Specialized tool nomenclature should describe the specific task it is intended to accomplish and should not be identified with the equipment it is servicing.
- Tool Stowage Labels – Prominent labels should be provided adjacent to each tool in the stowage container or kit if the tool is not readily recognizable.

- Tool Metric/English Identification – Tools should be labeled or coded to indicate whether the tool is sized in metric or English units.
- Tool Inventory Control Labeling – Tools should be tracked by an automated inventory control identification system.
- EVA Tool Compatibility – IVA tools that are not EVA-compatible should be labeled and identified as such.

9.4.7 Tool Access

The following tool access volume guidelines are applicable to both IVA and EVA hardware design (see Figure 9.4-4):

- Tool Head Clearance – Where only tool access is required, 2.5 cm (1 in.) clearance should be provided around the fastener or drive stud for insertion, actuation, and removal of the drive end of the tool. However, internal hex head fasteners may need less clearance for a hex head bit or Allen wrench (see Figure 9.4-5 for alternate clearance).
- Tool Handle Clearance – A minimum of 7.6 cm (3 in.) should be provided for clearance between a tool handle engaged on a fastener or drive stud and the nearest piece of hardware. The tool handle should be able to maintain this clearance through a full 180° swept envelope, since repeated motion through a smaller angle can be fatiguing. However, this may not be necessary, especially with ratcheting tools that have a 45° throw angle.
- Tool Head-to-Fastener Engagement Height – The tool socket or fastener head engagement height should be sufficient to lower the bearing loads on the fasteners and tool below the failure limits of the materials.
- Tool Handle Offset – The maximum tool offset between the tool handle and the tool head should be 35.5 cm (14 in.).

Access guidelines for hand actuated tools to be used during IVA operations can be found in Figure 9.4-6, Minimal Clearance for Tool-Operated Fasteners.

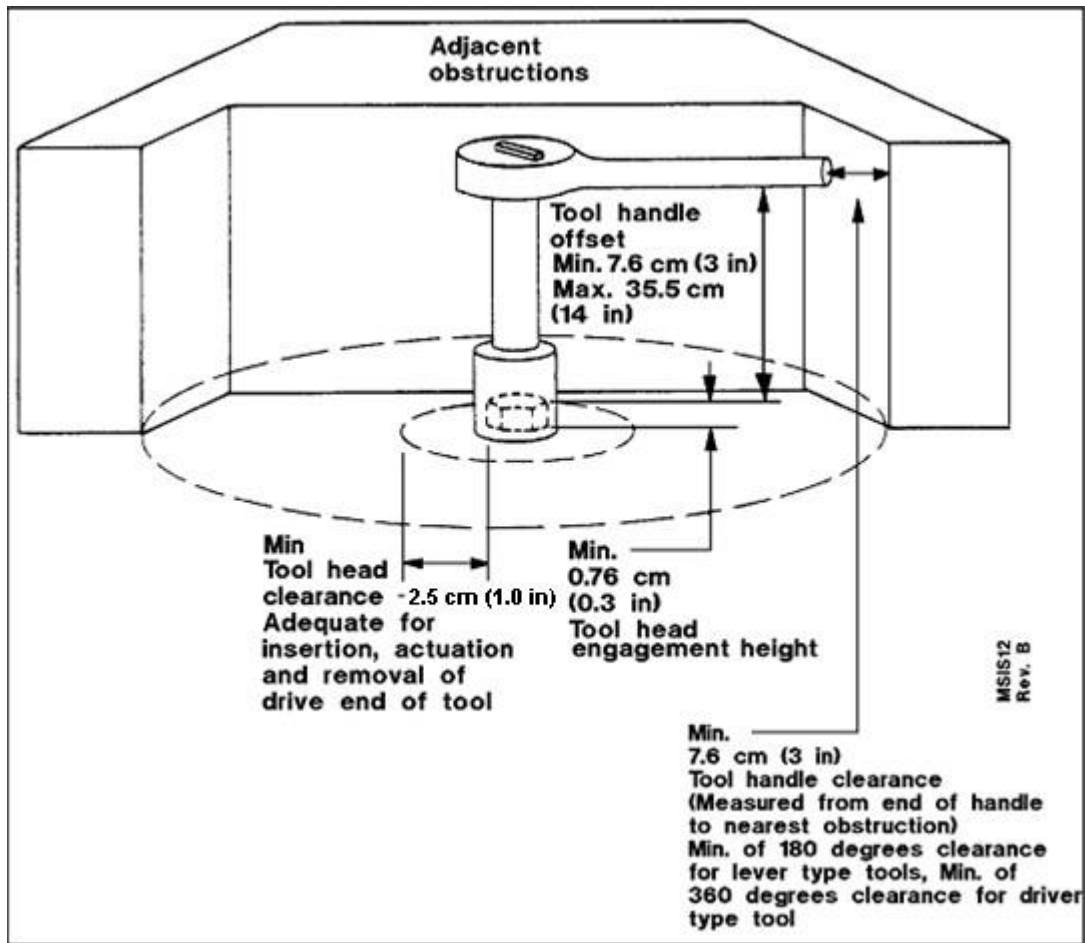


Figure 9.4-4 Tool access requirements. (IVA) (GIAG-3, 1986)

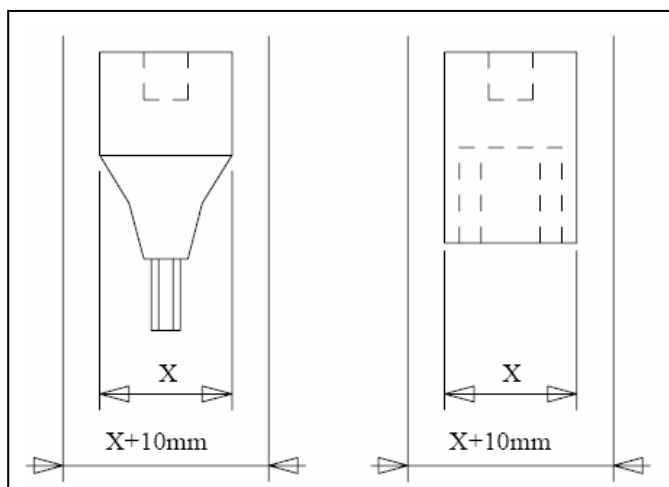


Figure 9.4-5 IVA tool head clearance.

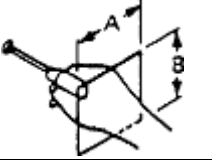
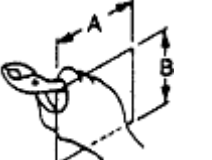
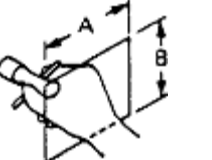
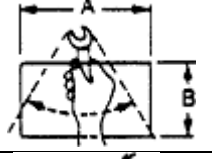
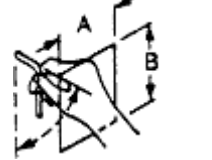
Opening dimensions		Task
	A 117 mm (4.6 in.) B 107 mm (4.2 in.)	Using common screwdriver with freedom to turn hand through 180°
	A 133 mm (5.2 in.) B 115 mm (4.5 in.)	Using pliers and similar tools
	A 117 mm (6.1 in.) B 107 mm (5.3 in.)	Using T-handle wrench with freedom to turn wrench through 180°
	A 203 mm (8.0 in.) B 135 mm (5.3 in.)	Using open-end wrench with freedom to turn wrench through 62°
	A 122 mm (4.8 in.) B 155 mm (6.1 in.)	Using Allen-type wrench with freedom to turn wrench through 62°

Figure 9.4-6 Minimal clearance for tool-operated fasteners. (MSFC-STD-512A, 1976)

9.4.8 Research Needs

Research is needed to determine the basis for the 180° sweep envelope and whether this is based only on the ability to torque or turn a fastener, or whether the envelope is also intended to provide flexibility in how the operators are able to orient themselves at the task site, based on the position of the tool handle.

9.5 DRAWERS AND RACKS

9.5.1 Introduction

This section will discuss racks, stowage drawers, and equipment drawers. Stowage drawers are used to stow removable contents, and generally do not have utility connections. Equipment drawers are used to mount subsystem components. The contents usually need to be removed or replaced using a hand tool. Equipment drawers have utility connections (such as power and thermal control).

9.5.2 General Drawer and Rack Features

When designing stowage drawers, equipment drawers, and racks, consider the following:

- Location – High-traffic areas should be avoided when locating racks that require frequent drawer deployment.
- Unobstructed Volume – Adequate clearance should be provided to allow for drawers to be opened, removed, and replaced without obstructions from adjacent hardware.
- Easily Removable – Drawers should be designed to be removed from their rack or cabinet along a continuous straight or slightly curved path without the use of tools.
- Limit Stops:
 - Limit stops should be provided that prevent the drawer from being unintentionally pulled out of the rack and hold the drawer in the open position.
 - Limit stops should allow for disengagement without the use of tools to enable drawer removal.
- Drawer Movement Forces – Drawer opening, closing, removal, and installation forces must be within the strength capabilities of the crew.
- Alignment Guides – Guide pins or equivalent features should be provided to aid in proper alignment when replacing a drawer into a rack or cabinet.
- Latches, Handles, and Operating Mechanisms – All latches, handles, and operating mechanisms should be designed to be easily latched, unlatched, opened, and closed with one hand without having to use any operating instructions. The ISS crews have reported that drawers that had a sliding panel over the top, the latching mechanisms and top sliding panels periodically stuck. Additionally, the use of the sliding panel required a two-step operation each time the drawer was accessed. The crews felt that in space, this type of complexity is not necessary. A simple Velcro latch, simple cloth hinge, or normal piano hinge was suggested as an adequate or preferred design. Additionally, the usability of the drawer design should not be degraded by closing and locking features that are driven by launch loads (OpsHab, 2001). Drawer handles should be low profile or with rounded corners to prevent snagging on clothing
- Latch/Unlatch Status – The design should be such that it is obvious when the drawer is not fastened or locked when in the closed position.

9.5.3 Stowage Drawers

In addition to the considerations above, the following apply to the design of stowage drawers:

- Restraint of Contents
 - Drawer contents should be restrained in such a way that the items do not float free when the drawer is opened, or jam the drawer so it cannot be opened or closed in 0g.
 - Drawer contents should be restrained in such a way that the contents can be removed and replaced easily without the use of a tool. Experience on the ISS has indicated that the tool locker drawers have been noted as stiff to pull out. In addition, the foam inserts used to hold the tools in place became worn, resulting in the tools sometimes getting dislodged and floating away. Worn Velcro has resulted in a tool or item coming loose and floating away. (OpsHab, 2001)
- Arrangement in Housing or Cabinet – Drawers should be arranged within their housing or cabinet so that the most frequently accessed drawers are in the most accessible locations.
- Access to Contents – Contents of drawers should be arranged so that the contents are visible and accessible when the drawer is in the open position.

9.5.4 Equipment Drawers

In addition to the considerations above, the following apply to the design of equipment drawers:

- Utility Connections
 - Utility connections should be designed to be easily disconnected and connected when the drawer is in the fully opened position.
 - Flexible umbilical utility connections must be designed to provide sufficient cable length for the drawer to be fully opened without disconnecting the cables.
- Equipment Layout on Rack
 - Components should be mounted in an orderly array on a two-dimensional surface, rather than stacked one on another (i.e., a lower layer should not support an upper layer).
 - Delicate items should be located or guarded so they will not be susceptible to damage while the unit is being handled or maintained.

9.5.5 Research Needs

More effort may be needed to consider partial-gravity effects on opening and closing of loaded drawers. Drawers must remain in the ideal operating position, and permit easy, non-binding operation.

9.6 CONNECTORS

9.6.1 Introduction

Connectors are essential to the assembly and disassembly of hardware and equipment, both during the construction and checkout phase and later during maintenance. Electrical, fluid, gas, structural, and optical connectors are discussed in this section. Guidance for connector selection, identification, alignment, spacing, accessibility, and protection of equipment is provided.

9.6.2 General Connectors

Experience from the ISS has indicated a crew preference for the use of quick disconnect (QD) connectors on hardware items with planned (regular) maintenance. Use of these connectors simplifies and reduces crew time and effort needed to perform maintenance. However, connectors are not completely reliable and most are susceptible to damage. For these reasons, connectors should be used only where needed.

Consider the following for connector selection, design, and applications:

- Connectors should allow for fast and easy maintenance operations
- Connectors should allow for easy removal and replacement of components and units. It should be possible to mate and de-mate individual connectors without having to remove or replace other connectors.
- Connectors should allow for minimal time to set up, test, and service equipment.
- Connectors must not subject personnel and equipment to potentially hazardous spills, electrical shocks, or damage from the release of stored mechanical energy, during the mating or de-mating.
- Connectors should allow for one-hand operation where possible. According to the ISS records, some of the non-QD connectors reportedly require excessive force and/or pliers to operate.
- Connectors must accommodate the strength and anthropometry of the crew. The ISS experience indicates that when mating hydraulic connectors, the crew felt that their hands were too big to get a good grip on them, and that finger grasping was inadequate to generate the necessary force. Thus a tool was needed to enable their operation. The relationship of hand torque capability to fastener diameter illustrated in Figures 9.6-1 and 9.6-2 can be consulted for applicability to connector design. (OpsHab, 2008)
- Single rows of electrical connectors normally provide the best access. Multiple rows of connectors should be avoided, but if they are required, the connectors should be staggered.

9.6.3 Fluid and Gas Connectors

When designing IVA and EVA liquid and gas connectors, the following guidelines apply:

- Fluid Line Connectors – Fluid line connectors should be convenient to use, be permanently installed, and permit in-flight maintenance for all brazed or welded gas and liquid lines.

- Indication of Pressure Flow –All liquid and gas lines must provide positive indication of the gas pressure or fluid flow to verify that the line is passive before disconnection of connectors. QDs that are designed to be operated under pressure do not require pressure or flow indications.
- Fluid Loss – Liquid and gas connectors must minimize escape or loss of fluids, particularly any toxic materials, during connect and disconnect operations.

9.6.4 Electrical Connectors

When designing IVA and EVA electrical connectors, the following guidelines apply:

- Ease of Disconnect – Electrical connector plugs should be designed so that no more than one-full turn is needed to disconnect, or some other QD design should be provided.
- Self-Locking – Electrical connector plugs should provide a self-locking safety catch.
- Access – Electrical connectors and cable installations should be designed with sufficient flexibility, length, and protection to permit disconnection and reconnection without damage to wiring or connectors.
- Arc Containment – Electrical connector plugs should be designed to confine or isolate electrical arcs or sparks caused by mating or de-mating.
- Contact Orientation – The arrangement of contacts within connectors must be designed in such a way that when the connectors are de-mated there is no voltage potential on exposed male pins.
- Contact Protection – All de-mated connectors should be protected against physical damage and contamination.

9.6.5 Structural Connectors

When designing IVA and EVA structural connectors the following guidelines apply:

- Alignment provisions should be provided.
- Soft latching capability before full firm connection or full release should be provided.
- Positive lock indication should be provided.

9.6.6 Connector Arrangement

Designers should also account for the possibility of operation with EVA gloves. When designing IVA and EVA connectors, the following arrangement and spacing guidelines apply.

- Hand Access – Connectors must be spaced far enough apart that they can be grasped firmly for connecting and disconnecting. The worst case scenario to be considered is the largest hand in the crew population.
- Adjacent Connectors or Obstructions – Space between a connector and any adjacent obstruction should be compatible with the size and shape of the plugs.
- Alternate Configuration – 90° connector configurations should be provided to improve accessibility in cases where the space behind a connector is limited.
- Single Rows – Connectors arranged in a single row that need to be removed and replaced by an IVA crewmember must be spaced at a minimum of 3.56 cm (1.4 in.) apart (edge-

to-edge) for hand access during alignment and insertion. A separation of 41 mm (1.6 in.) must be provided for EVA connectors (based on Skylab space suit data) and preferred for IVA connectors (See Figure 9.6-1). Exact EVA connector spacing will depend on the design of the EVA suit.

- Staggered Rows – Staggered rows of connectors must be a minimum of 64 mm (2.5 in.) apart for IVA and EVA (based on Skylab space suit data; see Figure 9.6-2).
- Tools – If a tool is used, the hand access clearance to facilitate initial alignment by hand should be considered.

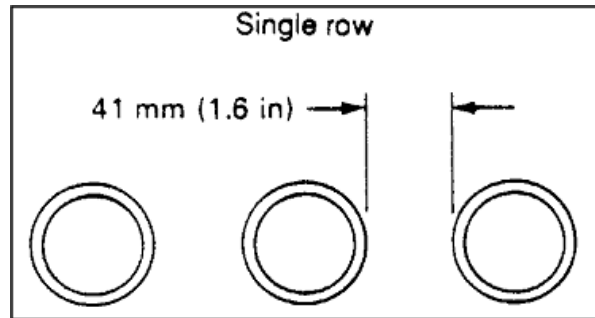


Figure 9.6-1 Preferred spacing of single row of connectors (bare or gloved hand). (MSFC-STD-512A, 1976)

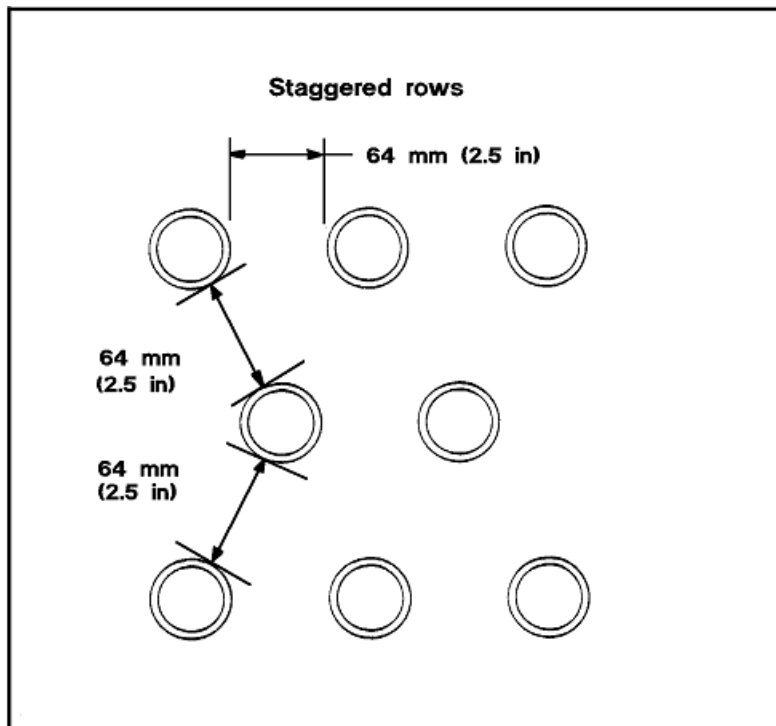


Figure 9.6-2 Preferred spacing of staggered single rows of connectors. (MSFC-STD-512A, 1976)

The following design consideration applies to the identification, coding, alignment, and marking of electrical connectors and receptacles.

- Coding – Alphanumeric coding should be used in preference to color coding (see Figure 9.6-3).
- Locating Labels – Alphanumeric coding of electrical connector plugs and receptacles should be located so they are visible when connected or disconnected.
- Keys and Keyways – Correct and incorrect methods of providing keys and keyways on electrical connectors are shown in Figure 9.6-4 and should be considered.
- Alignment Pins – A symmetrical pin arrangement with asymmetrical guide pin arrangement should be used to ensure proper alignment (see Figure 9.6-5).
- Alignment Marks – Alignment marks should be provided on electrical connector plugs and interfacing receptacles (see Figure 9.6-6). They are located so as to provide the crewmember with line-of-sight access during insertion.

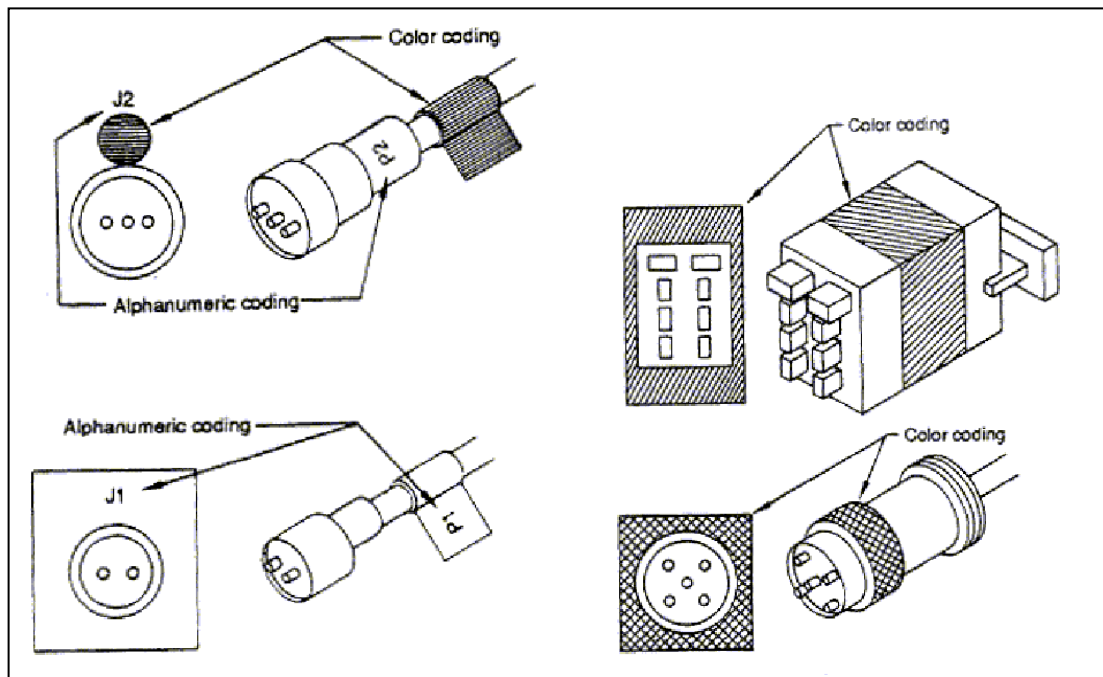


Figure 9.6-3 Color and alphanumeric coding of mating connectors. (MIL-HDBK-759A, 1981)

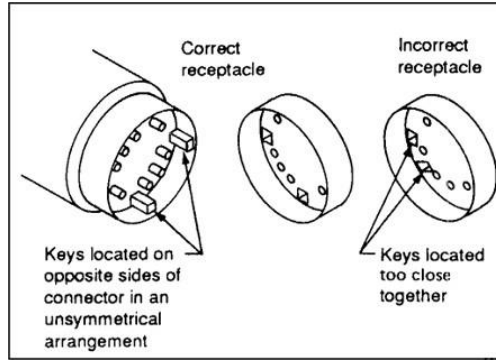


Figure 9.6-4 Electrical connector keys. (AFSC DH 1-3, 1972)

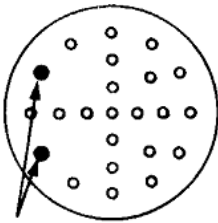
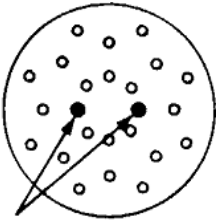
Use this	Not this
<p><i>This is a symmetrical pin arrangement with asymmetrical guide pin arrangement</i></p>  <p>Guide pins</p>	<p><i>This is a symmetrical pin and guide pin arrangement</i></p>  <p>Guide pins</p>

Figure 9.6-5 Arrangement of guide pins. (AFSC HD 1-3, 1972)

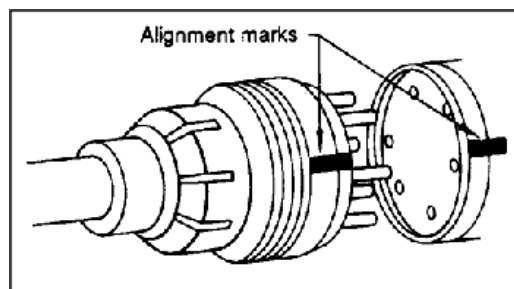


Figure 9.6-6 Alignment marks. (AFSC HD 1-3, 1972)

9.6.7 Research Needs

Research is needed to develop new materials to replace the rubber, metal springs, and other flexible materials currently used in bungee cords and other restraints. The materials currently used can release their stored mechanical energy abruptly and potentially cause injury to a crewmember. Ideally, a new material would release its mechanical energy gradually over 1 second, for example.

9.7 RESTRAINTS AND MOBILITY AIDS

9.7.1 Introduction

This section contains guidance for design of restraints and mobility aids for use primarily in microgravity conditions. However, mobility aids such as ladders and climbing handholds will be used on planet surfaces. Design criteria include dimensions, coding, texture, design loads, temperature limits, and mounting. Guidance for the design for portable and fixed foot restraints, body restraints, and equipment restraint devices is included.

9.7.2 Mobility Aids

Mobility aids allow crewmembers to efficiently move from one location to another in 0g, as well as reduce the likelihood of inadvertent collision into hardware, which may cause damage to the spacecraft or injury to the crew. Mobility aids include both of the following:

- Personnel Mobility Aids – Handles, grasp areas, kickoff areas, and other aids that are fixed to various points within the spacecraft.
- Equipment Mobility Aids – Handles and grasp areas fixed to packages or equipment that help with their movement and repositioning.

9.7.2.1 General Mobility Aid Design

Early experience in the Skylab program showed the problems of movement in 0g. Stopping, starting, and changing direction all require forces that are best generated by the hands or feet. Appropriately located mobility aids make this possible. If predefined mobility aids are not available, personnel will use available equipment, some of which may be damaged from induced loads.

The following are general guidelines and considerations for mobility aids:

- Pressurized-Suited Crew – Because of the limited maneuverability of a pressurized-suited crewmember, mobility aids must be provided to allow crewmembers to safely and efficiently enter and leave the spacecraft while they are in pressurized suits.
- Incapacitated Crew – Incapacitated pressurized-suited crewmembers may be unable to exit the spacecraft on their own, and may also be in a constrained position that requires assisted extraction. Mobility aids must be provided for the extraction of incapacitated crewmembers and may include spacecraft handholds, suit handholds for ground personnel, lifting devices, gurneys, or other devices. Also, because of the body's adaptation to 0g, some crewmembers (even if not incapacitated) may need assistance for some mobility tasks.
- Attachments – Systems can be optimized by simplifying and promoting commonality in how components are attached within the crew volume. The ISS crewmembers have reported that an excessive number of different interfaces exist for attaching components to a seat track. While the seat track provided a common interface on the spacecraft side, the restraints had numerous mechanisms for attaching to the seat track. Commonality on

both sides of the interface should be considered in the restraint system design to provide ease of use and to reduce crew training and real-time operations. (OpsHab, 2008)

9.7.2.2 Personal Mobility Aids

Personal mobility aids are handholds, ladders, and handrails used by crewmembers to help direct and control their movements. Crewmembers need to use them in both IVA and EVA as they move from place to place while performing tasks.

Handholds or handrails also provide local protection to the spacecraft or payload components. They also serve as convenient locations for temporary mounting, affixing, or restraint of loose equipment and as attachment points for equipment and personnel safety tethers. Handholds provide adequate restraint for low-force, short-duration manual tasks such as inspection, monitoring, and control or switch actuation. Handholds and handrails can be permanently installed or portable. Handhold areas are typically located around the edges of hatches, bulkheads, equipment, containers, and stowage lockers.

Handholds and handrails have been fabricated primarily from metals. Other rigid, semi-rigid, or cloth materials may be used.

The ISS crewmembers have expressed satisfaction with the overall operation, quantity, and location of the ISS handrails. However, the ISS crewmembers have sometimes grabbed a cable by mistake and pulled it out. Therefore, routing cables over or near handrails should be avoided. The ISS crew debriefs also show that handrails have been used as foot restraints and were preferred over the cloth foot restraints. This is addressed in section 9.7.3.1.1 Foot Restraints. Figure 9.7-1 shows a removable ISS handrail that attaches to a seat track.



Figure 9.7-1 Removable ISS handrail.

9.7.2.2.1 Mobility Aid Shape and Dimensions

When designing handholds and handrails the following cross-section design constraints apply:

- Standardization – Cross-sectional dimensions of handholds and handrails should be standardized throughout the spacecraft to provide a uniform interface for mounting items such as brackets and tether hooks.
- Cross-Sectional Shape – The cross-sectional shape of handholds and handrails should be designed so that the crewmember's hand or attached brackets will be stabilized (i.e., circular cross section should not be used). (Refer to Figure 9.7-2, IVA Handhold Cross Section)
- IVA Handhold Minimum Dimensions – All IVA handholds must have a minimum of 14 cm (5.5 in.) grip length and a minimum of 3.8 cm (1.5 in.) clearance between the lower surface of the handgrip and the surface on which it is mounted. (Refer to Figure 9.7-3)

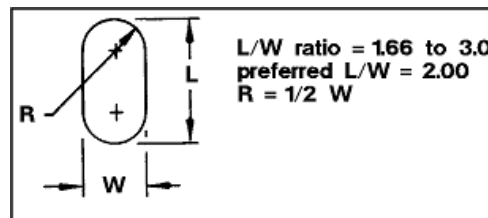


Figure 9.7-2 IVA handhold cross section. (MSFC-STD-512A, 1976)

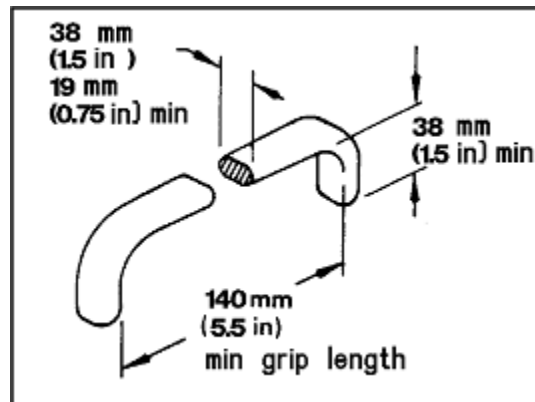


Figure 9.7-3 IVA handhold dimensions. (MSFC-STD-512A, 1976)

9.7.2.2.2 Coding

When designing handholds and handrail coding consider the following so that the crew may locate them with ease:

- Standard Color – The color of all handholds and handrails must be standardized within the spacecraft.
- Contrast Ratio – Where distinctive identification is needed, the color value should have a contrast ratio of 5:1 or greater with the background.

During emergencies, it is particularly important for crewmembers to be able to quickly distinguish mobility aids from the surrounding structures. Visual cues such as color-coding may aid in this function. Commonality among visual cues is important so that crewmembers can easily distinguish intended mobility aids from nonmobility aids that may be damaged by the application of crew-induced loads. For the Constellation Program, handrails will be colored International Safety Yellow.

9.7.2.2.3 Finish

For handhold and handrail textures the following design guidance applies to their feel and grasp:

- Identical Finish – The finish of all handholds/handrails should be identical to enhance identification.
- Non-Slip Surface – Handholds and handrails must have a nonslip surface with no burrs, sharp edges, or protrusions.

9.7.2.2.4 Design Loads

All fixed and portable IVA handholds and handrails must be designed to withstand expected loads of the crew without failure or damage that precludes full use by crewmembers.

9.7.2.2.5 Mounting

When determining how handhold and handrail will be mounted, consider the following:

- Stability – All fixed and portable handholds and handrails should be designed so that when installed they have no instability (i.e., looseness, vibration, or slippage).
- Portable Handhold and Handrail Lock Status Indication – Portable handhold and handrails should provide a positive indication of when they are in the locked position.
- Visibility and Accessibility – Handholds and handrails should be mounted so that they are clearly visible and accessible.
- Handhold Removal – Portable handholds should be removable and replaceable without the use tools.
- Safety – Handrails and associated mounting provisions should be designed so as to preclude snagging of body parts, clothing, or loose equipment (e.g., cables).
- Orientation – Handholds used for crew restraint and mobility should be designed to allow flexibility of mounting orientation. Experience from the ISS indicates that the hand and foot rails could be mounted only in a local horizontal or vertical direction. Feedback from use of these ISS restraints indicates that the crew needs multidirectional restraint capability, and the ability to overlap adjacent handholds. (OpsHab, 2008).

9.7.2.3 Equipment Mobility Aids

Equipment mobility aids are used by crewmembers to grasp and move equipment or stowage items in 0g. Consider the following guidance when determining the design of an equipment mobility aid system:

- Tethers should be used on equipment items being transferred but are not generally required for IVA.

- Equipment transfer by two crewmembers should be considered where transfer of large equipment may cause injury to the crewmember or damage to the spacecraft.
- Removable equipment mobility aids should be provided for use in locations where removal of the aids would be needed to provide clearance and access passage.
- Access – Design should consider whether the area around the mass is adequate for manipulation and visibility.
- Containers for Small Items – Containers should be provided for simultaneous transfer of small equipment items.
 - Single items should be individually removable.
 - The container should be easily attached to the crewmember and spacecraft at the worksite.
- Bump Protection – Bump protections can be designed so they can be used as mobility aids.

9.7.2.3.1 Handle and Grasp Areas

All removable or portable hardware, equipment, and units need to have handles or other suitable means for grasping, tethering, handling, and carrying.

When designing a handle or grasp area, consider the following factors:

- The operational location of the item relative to other items.
- The manner in which the item is to be handled.
- The distance the item needs to be moved.
- The frequency with which the item may need to be handled.
- The additional uses the handle may serve, such as the anchor for a tether or as a handhold.
- Handles should be located on either side of the center of mass.
- The number and location of handles should be determined by the mass, size, and shape of the object.
- Nonremovable handles should be recessed or fold flush with surfaces to minimize the potential for snagging clothing, equipment, or restraints.

9.7.2.3.2 Handle Shape and Dimensions

IVA handles for movable or portable units must be designed in accordance with the minimum applicable dimensions in Figures 9.7-4 and 9.7-5.

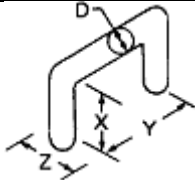
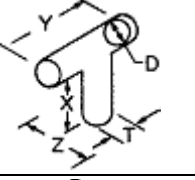

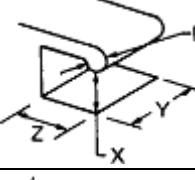
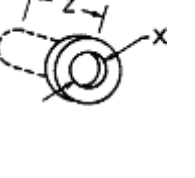
Illustration	Type of Handle	Dimensions in mm (in inches)		
		<i>(Bare Hand)</i>		
		X	Y	Z
	Two-finger bar	32 (1-1/4)	65 (2-1/2)	75 (3)
	One-hand bar	48 (1-7/8)	111 (4-3/8)	75 (3)
	Two-hand bar	48 (1-7/8)	215 (8-1/2)	75 (3)
	T-bar	38 (1-1/2)	100 (4)	75 (3)
	J-bar	50 (2)	100 (4)	75 (3)
	Two-finger recess	32 (1-1/4)	65 (2-1/2)	75 (3)
	One-hand recess	50 (2)	110 (4-1/4)	90 (3-1/2)
	Finger-tip recess	19 (3/4)	-	13 (1/2)
	One-finger recess	32 (1-1/4)	-	50 (2)

Figure 9.7-4 Minimum IVA handle dimensions. (MIL-STD-1472F, 1981)

Curvature of handle or edge (does not preclude use of oval handles)	Weight of item	Minimum diameter	Gripping efficiency is best if finger can curl around handle or edge to any angle of $2/3 \pi$ rad (120°) or more.
	Up to 6.8 kg (up to 15 lbs)	D = 6 mm (1/4 in)	
	6.8 to 9.0 kg (15 to 20 lbs)	D = 13 mm (1/2 in)	
	9.0 to 18 kg (20 to 40 lbs)	D = 19 mm (3/4 in)	
	Over 18 kg (Over 40 lbs)	D = 25 mm (1 in)	
	T-bar post	T = 13 mm (1/2 in)	

Figure 9.7-5 Minimum IVA handle dimensions for curvature. (MIL-STD-1472F, 1981)

9.7.2.3.3 Nonfixed Handles

When designing hinged, foldout, or attachable (i.e., nonfixed) handles consider the following:

- Locked or Use Position – Nonfixed handles should have a stop position for holding the handle perpendicular to the surface on which it is mounted.
- One-Handed Operation – Nonfixed handles should be capable of being placed in the use position by one hand and should be capable of being removed or stowed with one hand.
- Tactile or Visual Indicators – Attachable or removable handles should incorporate tactile and/or visual indication of status (locked or unlocked).

9.7.3 Restraints

This section covers means to stabilize and secure both people (personnel restraints) and equipment (equipment restraints). Restraints are primarily used in microgravity conditions, but are also used in transient hypergravity conditions (such as during launch or entry).

9.7.3.1 Personnel Restraints

Personnel restraints are used during nontranslating (fixed) operations and are required at liftoff, during major thrusting maneuvers, during 0g and partial-gravity operations, and during return-to-Earth operations.

During launch, abort, and entry, the potential exists for flail injury to the limbs if proper restraint is not used. Features such as harnesses, form-fitting seats, and tethers help maintain the proper position of the crewmember and prevent flailing. In addition, the design of the suit may contribute to reducing flail injury to the crew.

This section includes seat belts, shoulder harnesses, fixed and portable foot restraints, and body restraints. Handholds can also be used as personnel restraints. Donning/doffing, loads, materials, color, temperature limits, and dimensional requirements are included for each type of personnel restraint.

Table 9.7-1 shows types of personnel restraints used on Skylab and the ISS.

Table 9.7-1 Personnel Restraints Used on Skylab and ISS (MSFC-STD-512, 1974; OpsHab, 2001)

Crew task	Personnel Restraint					
	Handhold		Toe (foot loop)		Foot (triangular cleat)	
	Skylab	ISS	Skylab	ISS	Skylab	ISS
Meal preparation	✓	✓			✓	
Eating	✓	✓*			✓	
Flight data management	✓	✓			✓	
Consoles/spacecraft operations	✓	✓		✓	✓	
Robotics operations	N/A	✓*	N/A	✓	N/A	

Crew task	Personnel Restraint					
	Handhold		Toe (foot loop)		Foot (triangular cleat)	
	Skylab	ISS	Skylab	ISS	Skylab	ISS
Body waste collection	✓	✓*	✓			
Experiment operations	✓	✓*			✓	
Exercise operations		✓*				
General crew tasks, maintenance, and housekeeping	✓	✓, ✓*			✓	
Whole-body cleaning	✓		✓			
Stowage operations	✓	✓, ✓*			✓	
Equipment transfer	✓	✓			✓	
Personal hygiene	✓	✓, ✓*	✓		✓	

Note: ✓* = The ISS crew often used the handholds as foot restraints.

Maintaining a static position and orientation at a workstation is necessary to ensure that controls can be activated without motion being imparted to the crewmember. Without gravity to hold an individual onto a standing or sitting surface in 0g, the body will float or move in the direction opposite to an applied force. The cognitive and physical work required to maintain body position during a task can interfere with performance of the task. Previous orbital missions have indicated that, when properly restrained, crewmembers can perform most manipulative operations on orbit, using standard tools, as effectively as these operations can be performed in a 1g environment. In many 0g maintenance operations, adequate restraint was not anticipated in the design of the equipment and task to be performed, resulting in wasted time and crew frustration. Therefore, it is important to design with this in mind and provide adequate restraints for body stabilization for nominal and off-nominal operations. Although openings, holes, ductwork, and protrusions in and around equipment have been used by crewmembers as informal microgravity body restraints, a need for crew to rely upon improvised restraints is not acceptable.

Personnel restraints should be included where necessary to ensure that equipment is not damaged by inadvertent use as a restraint. For example, the ISS U.S. Laboratory window did not initially have surrounding handholds, causing the crew to use the nearby flexible pressure hose to provide the needed body stabilization. Repeated stress due to grabbing and holding the hose resulted in an air leak into space, reportedly at 5 times the normal rate.

When designing IVA and EVA personnel restraints (e.g., seat belts, shoulder harnesses, body restraints, foot restraints, and sleep restraints) consider the following:

- Comfort – Restraint forces should be reasonably distributed over the body to prevent discomfort, and it should not require conscious effort for a crewmember to remain constrained.
- Allowable Comfort Time – Comfort of the IVA restraint system should allow uninterrupted completion of expected tasks.
- Muscular Tension – Restraint design should minimize or prevent muscular tension.
- Anthropometric Range – All personal restraints must accommodate the specific population of users for whom the system is to be designed.

- 0g Posture – Personal restraints to be used in 0g applications must be designed for compatibility with 0g posture.
- Cleaning and Repair – The personal restraint system should be capable of being cleaned and repaired on orbit.

9.7.3.1.1 Foot Restraints

The following apply to all fixed and portable foot restraints:

- Location – The use of foot (and/or body) restraints should be considered where activities require the use of both hands, are long duration, and require precision.
- Standardization – Foot restraints should be standard throughout the spacecraft.
- Range of Motion – All foot restraints should maintain foot position to allow the crewmember a complete range of motion (roll, pitch, and yaw).
- Comfort – Foot restraints should provide comfortable support. Any portion of the restraint worn on the foot should be as low in mass as possible. For longer duration tasks, or tasks requiring reaction to high forces, designers of foot restraints should consider the use of padding or cushioning to prevent occurrences of callusing, scraping, or pressure-point buildup on crewmember extremities. However, care should be taken to preserve some level of rigidity for body control.
- Texture – Foot restraints should be textured to reduce slipping, since crewmembers often wear socks without shoes.
- Interchangeability – Attachment interfaces for foot restraints (portable-to-portable and fixed-to-fixed) should be interchangeable throughout the spacecraft.
- Retention – The foot restraint should firmly hold the user in the desired position.
- Loads – Foot restraints should provide the capability to withstand loads applied by the crewmember.
- Ventilation – IVA foot restraints and covers should allow ventilation of the feet.
- Fixed Foot Restraints – Fixed foot restraints should be capable of being removed for replacement or repair.
- Portable Foot Restraints – Portable foot restraints should be capable of being installed and removed easily and quickly without the use of tools.
- Donning and Adjustment – Foot restraints should be able to be donned (ingressed) or attached with minimum effort. On-orbit experience from the ISS crewmembers has shown that simple designs for donning, adjustment, and use of foot restraints are preferred. As an example, the ISS long-duration foot restraint (LDFR) provided adequate body stabilization for long-duration workstation tasks. However, the complexity of the design for adjustability created high overhead in restraint setup and discouraged its use. Thus for the majority of tasks, the crew tended to use the simpler short-duration foot restraints (foot plates with loops) or even the handrails.
- Quick Release – All IVA foot restraints should be able to release the foot quickly for rapid egress.
- No-Hand Operation – Foot restraint ingress and egress should not require use of hands at the restraint.

- Handholds – Handholds between the waist and shoulder should be available at all foot restraint locations to aid foot restraint ingress and egress.
- Entrapment – Foot restraints should minimize the danger of entrapment. A positive means of releasing the foot from the restraint should be provided.
- Tension and Torsion Loads – Foot restraints must be designed to withstand tension and torsion loads of the crew.
- Durability – Finish should be durable and smooth, and prevent undue wear on footwear.
- Color – Color for all foot restraints of a given type should have a contrast ratio of approximately 10:1 or greater with the background.

The ISS crews have found that handrails, designed mainly to be translation mobility aids, are useful foot restraints even for the longer-duration robotics operations. The handrails provided better rigidity (and restraining control) than that provided by foot restraints made of fabric. In many cases, such as medical experiment operations, the crew felt that just one handrail as a restraint was adequate for the stability needed (OpsHab, 2001).

The following figures show examples of foot/leg restraints:

- Figure 9.7-6 shows an example of a lower-leg restraint available on the Skylab.
- Figure 9.7-7 illustrates the short-duration foot restraint used on the ISS.
- Figure 9.7-8 illustrates the LDFR used on the ISS.
- Figure 9.7-9 illustrates the long-duration crewmember restraint used on the ISS. This is an adaptation of the LDFR and attaches hardware to the lower foot rail to provide upper leg restraint for increased stability at workstations (glove box, robotics).

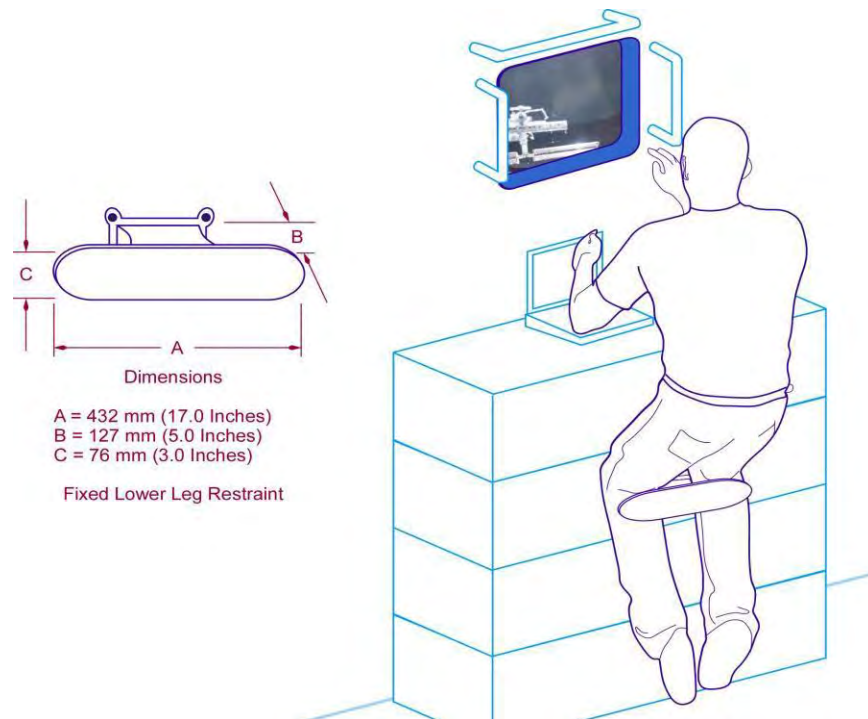


Figure 9.7-6 Example of lower leg restraint on Skylab. (MSFC-STD-512, 1974)



Figure 9.7-7. ISS short-duration foot restraint (attaching to an ISS handrail).



Figure 9.7-8. ISS long-duration foot restraint (attached to workstation seat track).

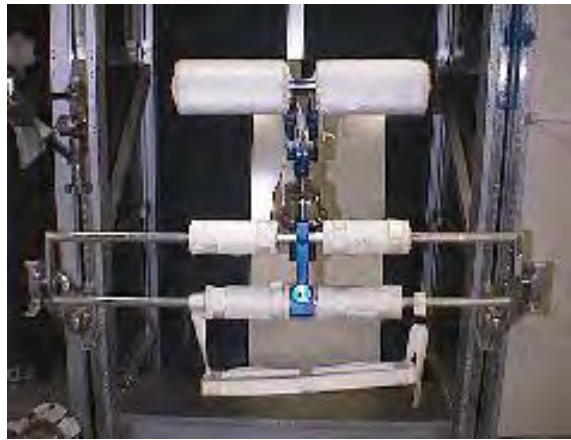


Figure 9.7-9 ISS long-duration crewmember restraint.

9.7.3.1.2 Body Restraints

Body restraints include tethers, seat belts, and harnesses that can be used in microgravity to stabilize the body for task performance (as an alternative or supplement to foot restraints). Body restraints are also used to restrain and stabilize the body during the high accelerations of launch and entry.

The following crewmember body restraint guidelines apply to all tether attachments, seat belts, and shoulder harnesses:

- Latching Mechanisms – The latching mechanism attachment should require a positive action by the crewmember to both latch and unlatch the mechanism.
- One-Handed Operation – The latching mechanism should have the capability of being latched and unlatched with one hand.

9.7.3.1.2.1 Body Restraint Loads

The following load recommendations apply to seat belts, shoulder harnesses, and IVA tethers:

- Seat Belts and Shoulder Harnesses – IVA seat belts and shoulder harnesses installed at stations designated as occupied during launch and landing must be designed so the occupant making proper use of the equipment will not suffer serious injury when the maximum forces of launch and landing, acting separately, are imposed on the crewmember.
- Body Harnesses – Body harnesses should have lifting attach points that can be used in lifting or hoisting the crewmember during egress operations in a 1g environment. The body harness should be designed to support the load of the crewmember while being lifted or hoisted. The body harness can be designed to be an integral part of the suit or be designed as a separate harness to be worn in addition to the seat belt and shoulder harness restraint system.
- Tether Attachments – IVA tether attachments should be capable of sustaining the maximum expected loads by the crew.

9.7.3.1.2.2 Body Restraint Dimensions

The following dimensional recommendations apply to seat belts, shoulder harnesses, and tethers:

- Commonalty – Seat belts, shoulder restraints, waist restraints, and tether attachments should be uniform in size, shape, and method of operation within the limits of task performance and other design tradeoffs.
- Size – Task requirements should be considered when determining the size of the restraint. The crewmember size ranges (see section 4.3 Anthropometry) must be accommodated in the design of restraints.

9.7.3.1.3 Sleep Restraints

When designing sleep restraints, consider the following:

- Extremity Restraint – Sleep restraints should include provisions to prevent leg and arm float and prevent the head from moving during sleep.
- Trapped Air – Sleep-restraint design should eliminate excessive or unevenly distributed trapped air.
- Individual Sleep Restraints – One sleep restraint should be provided for each crewmember.
- Stowage, Transport, Cleanability – Sleep restraints should be easily stowed, transportable, and cleanable on orbit.
- Features – A sleep restraint should incorporate the following features:
 - Adjustable, flexible restraint straps.
 - Arm slits.
 - Adjustable, removable pillows or head strap.
 - Adjustable thermal protection.
- Opening and Closing – A sleeping bag opening and closing device should extend the full length of the bag. The device should be easy to use, and must be quick to open in case of emergency.

- Torso Restraint – Torso restraining straps should be provided to allow the crewmembers to restrain themselves in their choice of sleeping position.

Figure 9.7-10 shows the sleep restraint configuration used on the Space Shuttle.

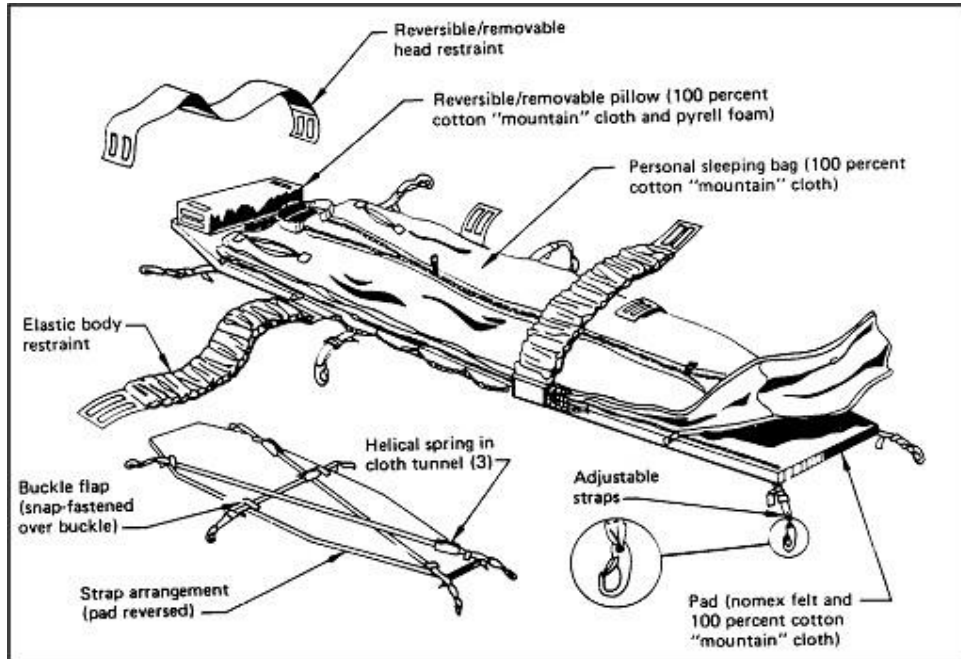


Figure 9.7-10 Shuttle sleep restraint. (JSC-12770, 1985)

9.7.3.2 Equipment Restraints

Equipment restraints are needed in microgravity to retain tools or equipment at workstations and storage locations. Also, temporarily restraining equipment in microgravity is very important. Everything from new shipments and supplies to small nuts and bolts need to be secured at storage and work sites to keep them from floating away. In addition, restraints will be needed to secure items during engine burns. Restraints include tethers, tape, bungee cords, Velcro, bags, and various specialized restraints.

9.7.3.2.1 General Equipment Restraint Design

When designing IVA and EVA equipment restraints, the following guidelines apply:

- Hand-Operated
 - Equipment restraints should be designed so that tools are not required to attach or detach the restraint.
 - Equipment restraints should be designed so that they can be attached and detached by either the left or right hand.
- Blind Operation – The equipment restraints should be designed so that the user can attach and detach them without having to look at them.
- Adjustable – Equipment restraints should provide the capability to adjust the restraint to adapt to a wide range of sizes of the items. These restraints should provide the user with

the adjustability to restrain the item at a preferred location relative to the restraint attachment points. This does not preclude the use of fixed-length tethers for specific applications.

- Positive Restraint – Equipment restraints must secure the item such that the item will not come loose as a result of inadvertent touching, air currents, spacecraft dynamic motions, or other predictable environmental conditions.
- Damage – The equipment restraint should be designed so that it cannot pinch, abrade, or cut the item to be restrained, interfacing surfaces, or adjacent hardware.
- Color – Equipment restraints should have a standardized color to distinguish them from loose equipment or items that will be restrained.
- Commonality – Equipment restraints should have a common design.

9.7.3.2.2 Specific Restraint Systems

When designing specific restraints, the following guidelines apply:

- Individual Restraints
 - Individual restraints should be used when the item to be restrained is large, sensitive, or delicate, or when attachments are difficult or complex in operation.
- Group Restraints
 - Group restraints should be used to restrain like-sized items wherever possible.
 - Group restraints should provide a system that allows the removal of one item at a time.
- Velcro – When Velcro is used as a restraint, the item to be restrained should be equipped with hook-type Velcro and the restraining surface should be equipped with pile-type Velcro.
- Adhesive Residue – Adhesive equipment restraints should not leave an adhesive residue on the item or on the spacecraft surface when the adhesive restraint is detached.

9.7.3.2.3 Tethers

When designing tethers, the following guidelines apply:

- Common attachment method – All equipment tethers should use a common attachment method.
- Tether attachment points – All equipment items that require tethering should have a standardized tether hook receptacle as an integral part of the item. This standardized receptacle should be provided on the interfacing surface to which the item is to be secured.
- Tether lock status indication – The tether hook should be designed such that it will be easy to recognize whether the hook is locked or unlocked in both daytime and nighttime lighting conditions.

9.7.3.2.4 Loads

- Minimum load – The minimum design load should be based on the expected crew-imposed and environmental loads to be applied to the item in the normal operating conditions.
- Maximum load – The maximum design load should be based on the resultant load imposed by a crewmember attempting to dislodge a restrained item that has become entrapped in adjacent hardware. The stress of this activity should not exceed the design load of the surface to which the restraint is attached or the design load of the entrapping hardware (i.e., the restraint should break before the item, attachment surface, or entrapping hardware breaks).

9.7.3.2.5 Example Equipment Restraints

Examples of equipment restraints are shown in Figures 9.7-11, -12, -13, -14 and -15.

- Temporary Stowage Bags – Temporary stowage bags are typically transparent so that the contents are visible (i.e., use transparent plastic or netting).
- Gray Tape – Apollo, Skylab, ISS, and Space Shuttle missions have used gray tape extensively as a temporary restraint for IVA operations. Use in EVA was not always acceptable because the adhesive capabilities may have been affected by temperature extremes.
- Cable Restraint Clips – These were used extensively in Apollo and Skylab missions. One set of cable restraints used on the Space Shuttle is the steel spring-loaded pass-through. These restraints were also modified to allow attachment to seat tracks on the fronts of equipment racks on the ISS. Figure 9.7-11 shows the ISS cable/wire restraint. Another option offering versatility and ease of use is the quick twist wire mount assembly, shown in Figure 9.7-12. This ISS wire restraint has an adhesive backing to allow flexibility in mounting locations. However, many ISS crewmembers do not like these because they pop out of the seat track too easily.
- Bundling Wrap Assembly – This restraint uses a Teflon helical bundling assembly to organize and secure data cables and wires. Figure 9.7-13 shows the 8-in. bundling wrap assembly (5/16 to 8 in.). Another option exists for bundles with a maximum diameter of 3 in.
- Velcro – Velcro can provide an acceptable equipment restraint, but its limitations and possible complications from its use need to be understood. The adhesive holding the Velcro pad needs to be stronger than the retention capability of the Velcro hook-and-pile linkage. Adhering qualities of the hook and pile are quite dependent on the material. Temperature constraints may prohibit its use in EVA. The ISS experience with use of Velcro indicated it was useful for certain needs, but also had undesirable characteristics:
 - Velcro use in the sleep station worked very well.
 - Velcro weakened over time.
 - Velcro was adequate for very temporary stowage needs.
 - Velcro tended to trap dust and debris.

- Straps with Snaps and/or Velcro – Crewmembers require handholds or foot restraints to mate female snaps to spacecraft structure studs in a microgravity environment. Snaps are also difficult to align during EVA.
- Metal and Elastic Bungee Springs with Snaps or Flat Hooks – These are recommended for IVA use only, but they were the most widely accepted retention devices used on Apollo, Skylab, and Space Shuttle missions. Both the metal springs and the elastic tend to stretch after extended use and snaps are difficult to attach to structure-mounted interfacing studs in a microgravity environment.
- EVA Tethers – Fixed-length, adjustable, and retractable tethers have been used extensively in EVA operations but can also be used for IVA operations.
- Rubber Bands – Experience on Skylab missions showed that rubber bands were an excellent device to prevent flight manuals and checklists from inadvertently opening in microgravity.
- Other Devices – Many other equipment restraint devices have been tried. These include pip pins, dog leash clips, pinch clamps, and snap rings.

The overall lesson learned from the ISS is that restraints for loose items need to be simple, and that bungees were preferred because they require less force and are easy to set up. Specifically, the ISS crews made the following comments (OpsHab, 2001):

- Bungees used across the dining table were useful for holding down food items.
- Bungees work well and provide the best equipment restraint.
- The flat Russian bungees were preferred to the round U.S. bungees.

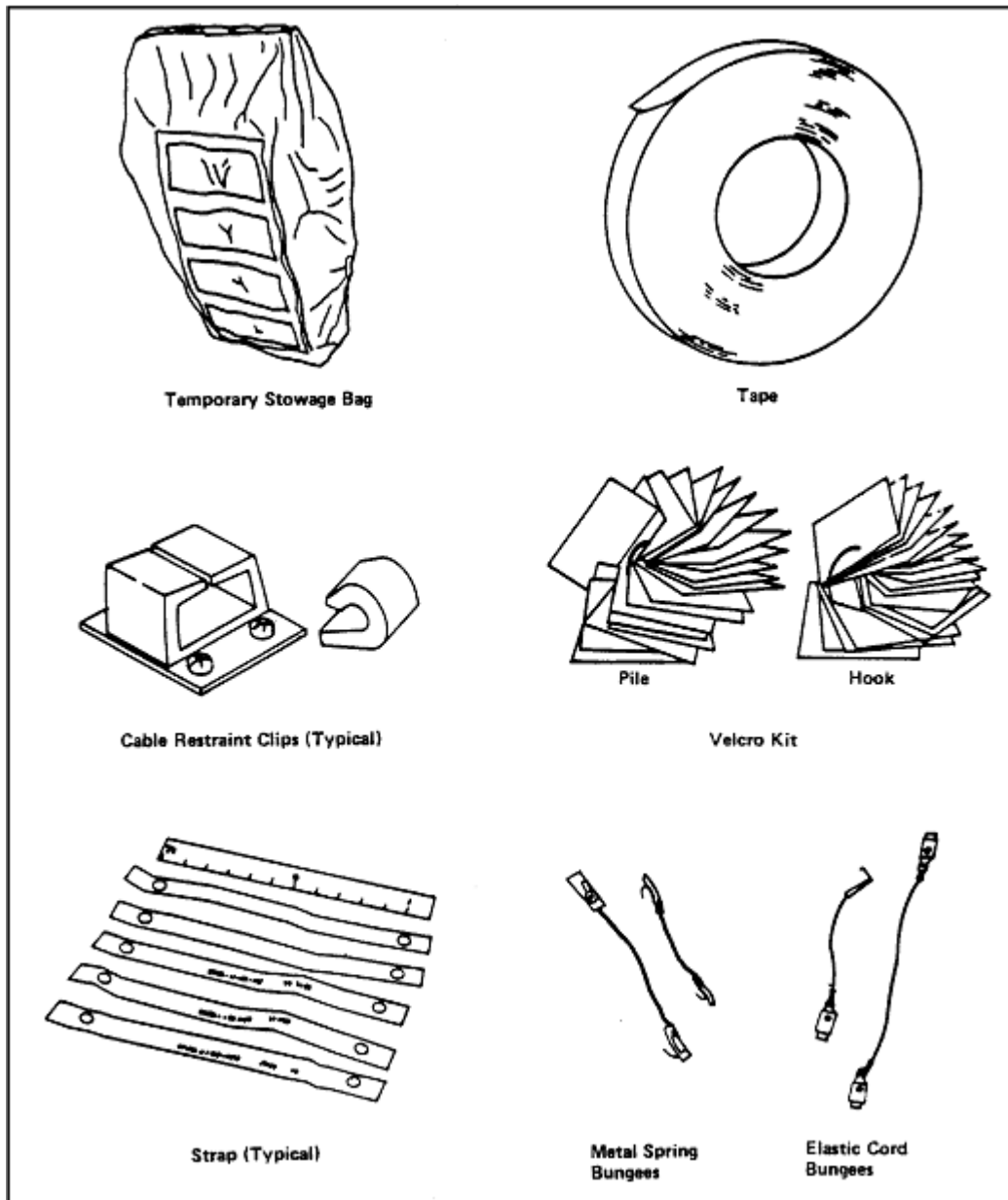


Figure 9.7-11 Examples of equipment restraints. (JSC 12770, 1985)



Figure 9.7-12 ISS cable restraint.



Figure 9.7-13 Quick twist wire-mount assembly.

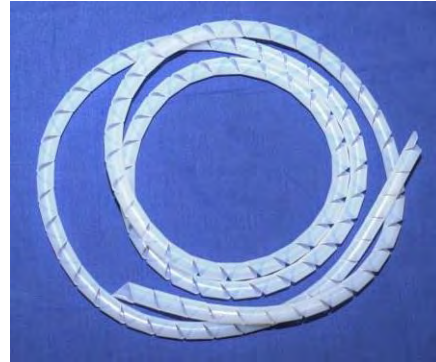


Figure 9.7-14 ISS 8-in. bundling wrap assembly.



Figure 9.7-15 Russian flat bungees (left), U.S. large adjustable round bungee (right).

9.7.3.2.6 Unique Equipment Restraints

Unique equipment restraints have been designed and used on both the Space Shuttle and the ISS. These unique restraints are needed for hardware operation or provide additional flexibility and accommodation of multiple equipment items. Examples of these unique restraints follow:

- Flexible Bracket – The ISS example shown in Figure 9.7-16 is similar to the Space Shuttle LocLine Bracket with the exception that it is adapted to interface with the seat track. This bracket consists of a series of flexible hose segments that fit together to form a flexible bracket. A camera shoe interface (female) is provided on the flexible bracket. Attaching hardware needs to have a male camera shoe interface.

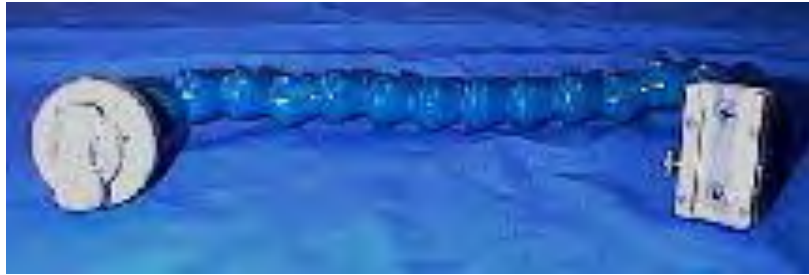


Figure 9.7-16 Flexible bracket.

- Multiuse Bracket – The ISS example shown in Figure 9.7-17 is similar to the current Space Shuttle multiuse bracket with the exception that it is adapted to interface with the seat track. This restraint uses a mechanical arm with a central elbow and ball joints on each end; a single knob at the elbow joint tightens all joints. Like the flexible bracket, the multiuse bracket has a camera shoe interface (female). Attaching hardware needs to have a male camera shoe interface. The ISS on-orbit experience indicates that the multiuse bracket is useful, but joints became loose and required occasional tightening.



Figure 9.6-17 Multiuse bracket.

- Payload Equipment Restraint System. The system shown in Figure 9.7-18 is being used on the ISS (“H” Strap and attaching components). It is described as a modular system of fabric components designed to allow crew operations for handling and restraining a large variety of loose equipment and tools at various worksites. All items related to operation or maintenance can be co-located for quick access and use, and the ISS crewmembers have cited the device as invaluable for temporary stowage.

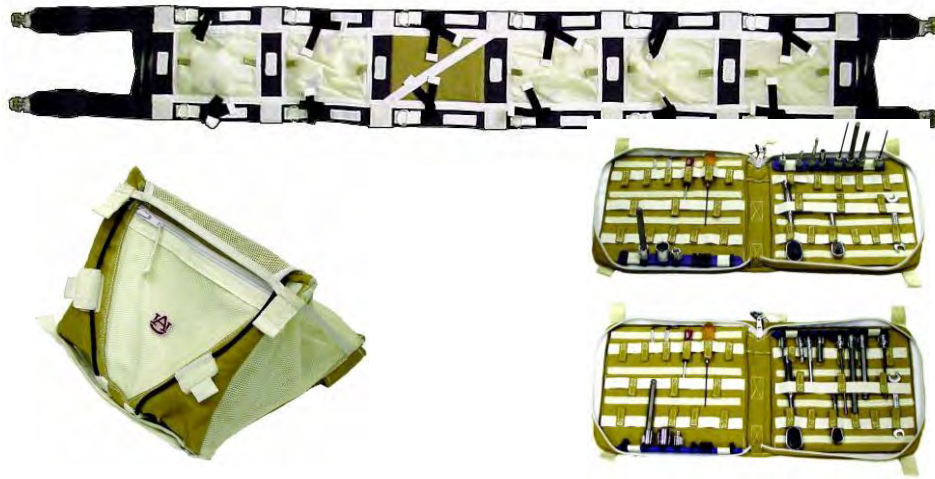


Figure 9.7-18 Payload equipment restraint system.

The set of common IVA equipment restraints used on the ISS can be found in the IVA ISS Catalog of IVA Government-Furnished Equipment Flight Crew Equipment, JSC 28533.

9.7.4 Research Needs

RESERVED

9.8 CABLES

9.8.1 Introduction

The primary purpose of interconnecting cables is to transmit power and data reliably to and from various parts of the spacecraft. The design, routing, and identification of cables are important for ensuring safe and efficient operations

9.8.2 Cable Design and Routing

When designing or provisioning cables for a spacecraft or hardware, consider the following guidance:

- Cable length should permit
 - Hardware to be inspected and maintained in a convenient place.
 - Hardware to be withdrawn from drawers or slide-out racks without breaking electrical connectivity.
- Cables should be fanned out in junction boxes for easy checking, especially if there are no other test points in the circuits.
- Cables should be routed so they
 - Cannot be pinched by doors, lids, or slides.
 - Will not be used as a translation device.
 - Will not be bent sharply under any condition.
 - Are easily accessible to the crewmember.
 - Do not infringe into the operational envelope nor constitute a safety hazard (e.g., sagging, hooking).
- Location of Cables – Cables should not interfere with crewmember movement, or with controls or displays.
- Retention – A means should be provided to retain the ends of cables near their connection points.
- Cable Clamps – Long conductors, bundles, or cables should be secured by clamps unless they are contained in wiring ducts or cable retractors.
- Protection – Guards or other forms of protection, such as strain relief, should be provided for easily damaged conductors such as wave guides, high-frequency cables, or insulated high-voltage cables.

The ISS crewmembers have made the following comments (OpsHab, 2008) about the design, quantity, and location of the ISS cabling:

- There are too many cables on the ISS.
- Cables became a “trip” hazard.
- The crew had to work around the cables all the time, and many of the cables seem unneeded and unused.

- Managing cables has taken too much crew time and was more complex than training had indicated. Hardware providers need to minimize the quantity of cables the crew has to manage.
- Most of the cables were too long, which complicated hardware installation and decreased crew efficiency. For example, the crew noted they had a lot of 25-ft cables where only 10-ft cables were needed. Crewmembers would shove the extra cable in between racks.
- Common cable interfaces would result in more efficient operations and better maintenance access.

9.8.3 Cable Identification

Cables must be clearly labeled to indicate the equipment and connectors to which the cables mate. All replaceable wires and cables must be uniquely identified in accordance with section 10.6 Labels. In addition, individually insulated conductors within a common sheath must be color-coded. According to lessons learned by the ISS crew, cables that are not interchangeable should have dissimilar labels.

The following are operationally-proven cable management designs:

- Figure 9.8-1 is an example of cable marking and maintenance instruction techniques (note the cable identification location).
- Figure 9.8-2 is an example of markings provided on Space Shuttle cables. Note the locations of the cable identification part number and the labels for connector locations.

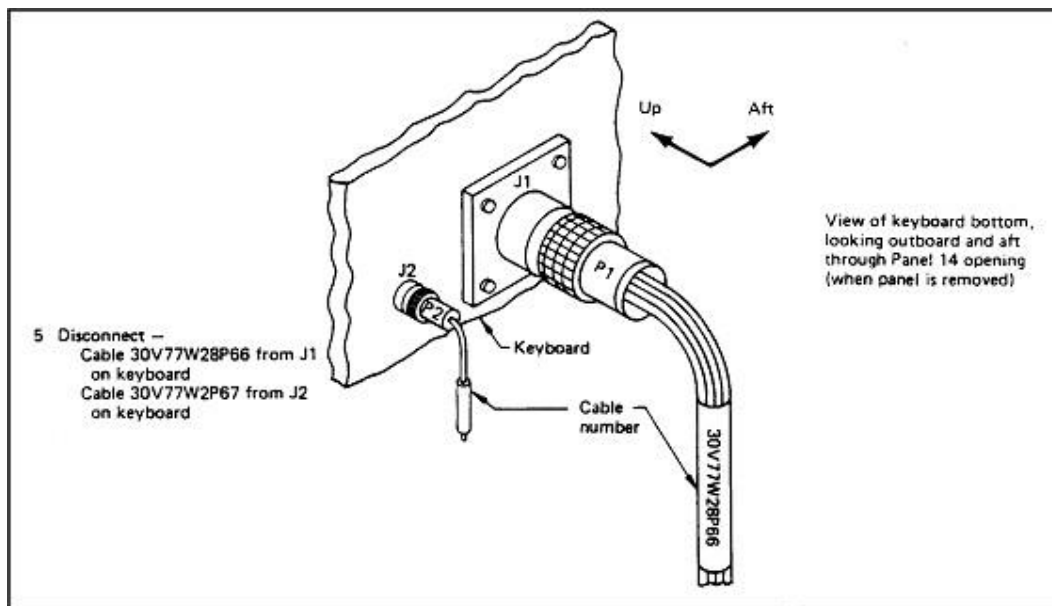


Figure 9.8-1 Cable identification technique. (AFSC HD 1-3, 1972)

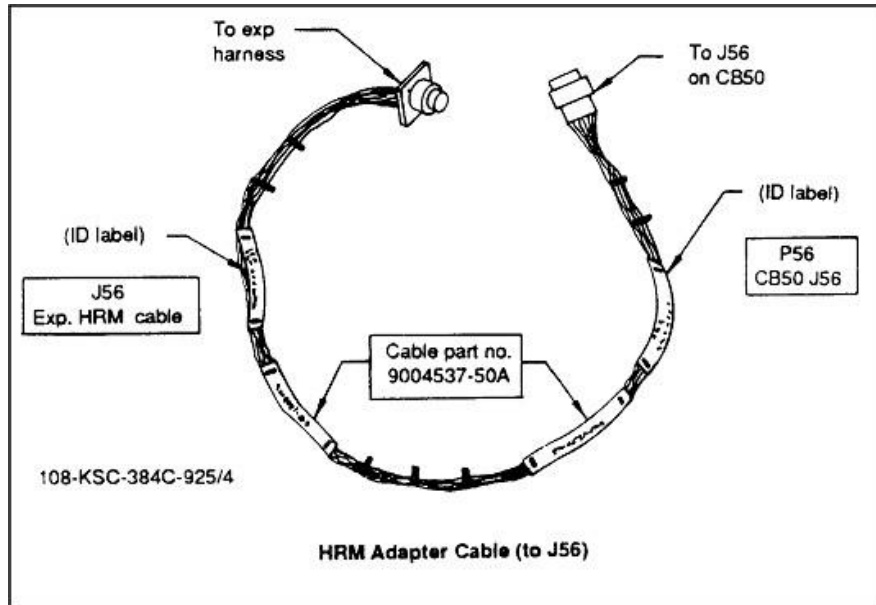


Figure 9.8-2 Spare or test cable identification methods. (JSC-18702, 1985)

9.8.4 Research Needs

RESERVED

9.9 CREW PERSONAL EQUIPMENT

9.9.1 Introduction

Personal equipment includes small, very useful items that crewmembers typically carry in their pockets. The personal equipment to be provided is determined by mission and program needs and requirements and each crewmember's personal preference.

9.9.2 General Considerations

The following are examples of personal ancillary equipment that have been found useful in previous missions:

- Penlights and Flashlights – Penlights and flashlights provide a portable light source for use during both IVA and EVA. They are used for handheld illumination of poorly lighted areas, of normal operations and maintenance tasks, and as a source of light in the event of cabin light failure. For hands-free operation, a headlamp assembly has been used.
- Pocket Knives – Pocket knives are reported to be one of the most essential instruments for tasks such as food preparation, repair work, opening packages, and cutting string. U.S. astronauts are provided a Swiss Army knife.
- Multifunction Tool – Another option available to the U.S. Space Shuttle and ISS crewmembers is the Leatherman Tool Assembly. This item offers multiple uses (pliers, wire cutters, scissors, file, screwdriver, saw, wire stripper, tweezers, punch, ruler), depending on 1 of 3 versions, and can be carried via a belt clip.
- Sunglasses – Crewmembers should be provided with sunglasses. These sunglasses should be restrained with straps or other appropriate devices to provide positive retention on the user. Eyeglasses or sunglasses should be made of shatterproof material. The U.S. ISS crewmembers are allocated one pair of sunglasses in a case, and two sets of elastic head strap restraints (“Croakies”) per mission.
- Wristwatch – A multipurpose wrist chronograph that incorporates both digital and analog functions has been an essential item on past space missions. Chronographs are used as wristwatches and stopwatches and need to be antimagnetic, protected from shock, function in both IVA and EVA, and easily read in daylight or darkness. The Timex Ironman Triathlon Watch has been offered for use by Space Shuttle and ISS crewmembers.
- Writing Tools – Ballpoint pens, marker pens, and pencils are also needed during space missions. For the ISS crewmembers, these types of items are supplied as part of an Office Supply Pantry. On future missions, computer displays may be the primary medium for procedures and checklists, but paper will likely be used for some tasks.
- Pockets – Ancillary equipment should incorporate pocket clips and/or Velcro patches for restraints. The ISS crewmembers can request a crew preference flight removable pocket, which mates via Velcro attachment to their clothing. The removable pocket has different sizes of compartments and flaps, to hold small personal items such as pens, markers, notepad, flashlight, knife, Leatherman, scissors, snacks, or other items.

9.9.3 Research Needs

RESERVED

9.10 CLOSURES AND COVERS

9.10.1 Introduction

Closures and covers for hardware and equipment are necessary, especially in 0g, to prevent loose items from getting into unintended locations. This is important because small items may not be easily retrieved from inaccessible locations, they may cause damage, or they may become lost. Closures and covers can also protect sensitive equipment from inadvertent damage by crewmembers. Finally, closures and covers can protect the crew by isolating moving parts, electrical hazards, snags, and sharp corners. For more detailed guidance information regarding closeout panels and covers see the *Crew Compartment Closeout Provisions* section of the NASA/TP-2006-213725 Crew Station Aspects of Manned Spacecraft Volume 2.

9.10.2 General Considerations

Closures and covers need to preclude access by crewmembers to dangerous areas such as electrical hazards, moving machinery, and temperature hazards.

Consider the following when designing equipment closures:

- Sealing – Sealing must be provided to inaccessible areas to prevent small items from drifting into them in 0g.
- Removal and Installation – Closures should be quickly and easily removed to allow maintenance of equipment. Additionally, design of panels in general should consider potential deformation of the spacecraft and equipment, which can occur in the transition from 1g to 0g. The ISS crewmembers have commented that the panels in the Node module were very tight-fitting and difficult to reinstall. (OpsHab 2008)
- Access – For frequently accessed areas, the closure attachment methods should minimize the number of fasteners and use captive and hand-operated fasteners.
- Securing – It should be obvious when a closure is not secured, even though it may be in place.
- Loads – Closures must be capable of sustaining crew-imposed loads and maintaining closure when these loads are applied.
- Instructions – If the method of opening a cover is not obvious from the construction of the cover itself, instructions (including applicable tool instructions) should be permanently displayed on the outside of the cover.
- Clearance – Bulkheads, brackets, and other units should not interfere with removal or opening of covers.
- Application – An access cover should be provided whenever frequent maintenance operations would otherwise require removing the entire case or cover, or dismantling an item of equipment.
- Self-Supporting Covers – Access covers that are not completely removable should be self-supporting in the open position in any gravitational environment in which they may be expected to operate.
- Ventilation Screen Access – Where ventilation screens, holes, or grids are used, the ventilation surface should be accessible (e.g., for cleaning, repair).

- Retention of Parts – Doors, covers, and retainers (e.g., screws and clips) should be retained (using tethers or hinges) so they do not become misplaced.
- Size of Ventilation Holes – Some hardware and equipment closures and covers require ventilation holes. These ventilation holes should be small enough that crewmembers cannot inadvertently entrap an appendage (e.g., finger) during translation or insert an object that might touch high voltage or moving parts.
- Cleaning – Ventilation holes, grids, screens, and mesh can provide surfaces for the accumulation of particulate and fibrous debris (e.g., dead skin flakes, fabric lint, and packaging scraps), so they should be accessible for cleaning.

Special hardware items, such as metal or rubber trim strips, moldings, fairings, or cover plates, can be used to seal off inaccessible areas and meet closure requirements. An example is shown in Figure 9.10-1.

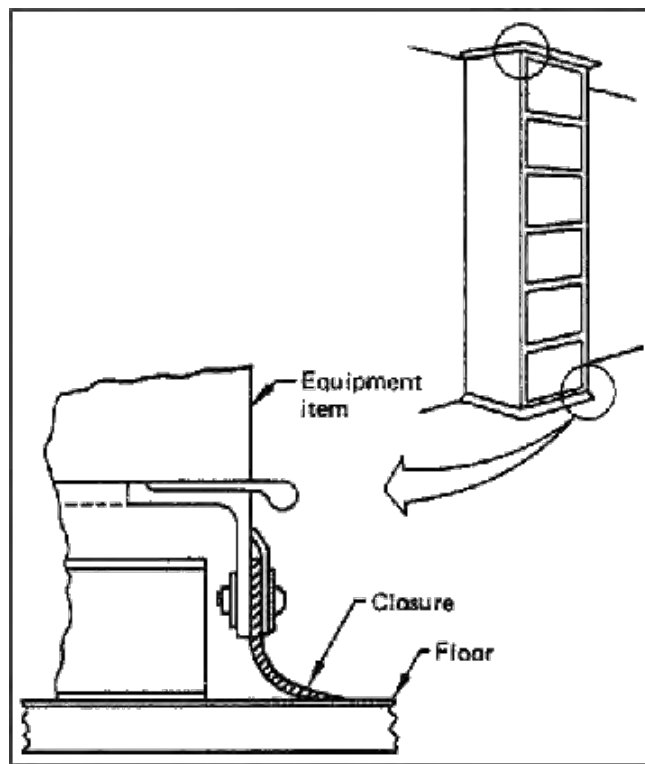


Figure 9.10-1 Example of use of closures. (MSFC-STD-512A, 1976)

9.10.3 Research Needs

RESERVED

9.11 FASTENERS

9.11.1 Introduction

Fasteners used by crewmembers include those that are used on access doors, containers, panels, equipment stowage, doors, covers, restraints, and orbital replacement units. Although the predominant fasteners in previous and current programs (such as the ISS) have been screws and bolts, fasteners can also include items such as hand-actuated and tool-actuated latches, catches, clamps, and connectors.

9.11.2 General Fasteners

The following applies to the design of fasteners:

- **Standardization** – Fasteners should be of a common type and size to minimize the number of types of tools required to operate fasteners, the crew workload required to collect the appropriate tools, and the potential for trying to use the wrong tool. Hand-actuated fasteners should also be of a common type and size to minimize the frustration of having to remember how to operate a variety of latches and fasteners.
- **Differentiation** – Different fasteners that are similar in appearance and cannot be easily distinguished should be avoided. For example, screws that differ by a small degree in length or diameter increase the probability that a size inappropriate for the intended application may be selected inadvertently.
- **Hand-Actuated Versus Tool-Actuated Fasteners** – Decisions as to which of these two types of fasteners are chosen for a particular application needs to be informed by the force required by crewmembers, the structural loading on the fastener, and frequency of use. Hand-actuated fasteners are generally preferred over tool-actuated fasteners when a hand-actuated fastener can meet the requirements for size, clearance, and structural loading for the particular application. Hand-actuated fasteners are preferred, as they will minimize the crewmembers' workload unless a large number of fasteners are required. In this case, fasteners activated by power tools are preferred. The ISS crewmembers have indicated that although the reason for using quarter-turn fasteners was to simplify the frequent access to hardware under panels, operations became complicated with the use of many (up to a dozen) quarter-turn fasteners per panel (OpsHab 2008).
- **Multi-turn Fasteners** – Where multi-turn fasteners are required, the fastener should fasten or unfasten in less than ten turns.
- **Clearance and Access** – Clearance must be provided around fasteners for the crewmember to obtain hand access for tool clearance and operation. Access and clearance should be considered for sockets, extensions, and lever arms. Consider that it might take two hands or a power tool to manipulate, break away, or remove stuck fasteners. Recessed fasteners should be avoided. Fastener mounting holes should be large enough to allow starting fasteners without perfect alignment.
- **Bare-Hand or Gloved Actuation** – When selecting fasteners, either hand-actuated or tool-actuated, consider whether the fasteners or the tool will be manipulated by the bare hand or with a pressurized glove.

- Safety – Exposed fasteners must be selected so that they will not snag clothing or cause injury to the crewmembers. Fasteners and latches must not spring open and cause injury to the crewmember.
- Minimum Number of Fasteners –The number of fasteners used in an application should be minimized.
- Tool-Actuated Fastener Head Type – For high-torque applications, use internal (Allen) or external hex-head styles.
- Fastener Replacement – Methods for replacing stripped, worn, or damaged fasteners should be considered. Avoid fasteners that are 1) an integral part of the equipment (e.g., threaded studs) or 2) countersunk.
- Dual-Purpose Fasteners – Dual-purpose fasteners should be used (e.g., a lock handle may be designed to serve as an extra handhold) whenever possible.
- Cotter Keys and Safety Wire – The use of cotter keys and safety wire should be avoided.
- Thread Fastener Installation and Replacement – Thread fasteners should be installed with torque-limiting tools.
- Force – Fasteners that require force to keep the tool engaged should be avoided in 0g since the pushing force will tend to push an unrestrained crewmember away from the fastener.
- Engagement Feedback — Feedback should be provided for engagement or disengagement of fasteners. In a 0g environment, fasteners such as screws and bolts may not provide correct feedback when they have been fully released from their mountings. There tends to be a surface adhesion component that may prevent the familiar fastener “pop-out” experienced in 1g.
- Captive Fasteners – All fastener components intended for crew interaction should be captive. A captive fastener is one that is automatically retained in a work-piece when it is not performing its load-bearing job, and therefore does not require the crew to restrain and store them during maintenance. Where washers or other locking devices are required, these items should also be designed to be captive to the bolt or locking nut and receptacle. Without this captivity, the number of loose parts that need to be handled by the crew and could be lost is effectively doubled. In cases where panels or hardware need to support high structural loads (for example, launch), a large number of fasteners may be needed for secured mounting. If these panels or hardware will be accessed routinely for maintenance or other purposes, a subset of the fasteners should be noncaptive and removable. After high loading has been experienced, removable fasteners could be stowed, thus reducing the workload imposed upon the crew when accessing the items during the mission. Stowage of removable fasteners should be local to the panel or equipment they were removed from. The presence of stowed fasteners in their stowage location or enclosure should be easily visible. All replaceable fasteners should be amenable to loose parts control, and a means of fastener containment and/or restraint should be incorporated in the fastener removal and replacement system.

9.11.2.1 Hand-Actuated Fasteners

In addition to the general fastener guidelines, the following hand-actuated guidelines apply:

- Actuation – Hand-actuated fasteners should be designed to be actuated by one hand and by either left- or right-handed crewmembers.

- Fastener Knobs – Fastener knobs should be textured for better grip.
- Quick-Opening Fasteners – Quick-opening captive fasteners should
 - Require a maximum of one complete turn to operate (quarter-turn fasteners are preferred).
 - Require only one hand to operate.
 - Be positive locking in open and closed position.
- Locking Threaded Fasteners – Hand-actuated threaded fasteners should have a locking feature that provides an audible, tactile, or visual feedback to the crewmember. Such locking features should ensure that threaded fasteners will not unthread themselves without crew actuation. The preference from the crew interface perspective may be to use locking helicoils rather than staking (need to break adhesive) or lockwiring (potential for sharp hazard).
- Pin Fasteners (IVA)
 - Alignment – Hardware using pin fasteners should be designed to accommodate misalignment of holes caused by on-orbit distortions of primary and secondary equipment.
 - Locking devices – Locking devices used in conjunction with pin fasteners should be made accessible and easily visible.
- Over-Center Latches
 - Nonself-latching – Nonself-latching latches should include a provision to prevent undesired latch element realignment, interference, or re-engagement.
 - Latch lock – Whenever possible, latch catches should be spring loaded to lock on contact, rather than using a positive locking device. If positive locking is necessary, provide a latch loop and locking action.
 - Latch handles – If the latch has a handle, the latch release should be located on or near the handle so it can be operated with one hand.
- Wing-Head Fasteners – Wing-head IVA fasteners should fold down and be retained flush with surfaces so they will not snag personnel, clothing, or equipment.
- Cotter Keys
 - Fit – Keys and pins should fit snugly without requiring the use of a tool.
 - Large heads – Cotter keys should have large heads for easy removal by hand.
- Forces to Operate – The force necessary to operate fasteners must be within the strength capabilities of the crew. Strength depends on the crewmember's restraint and the surface area provided for gripping by the tool or by hand. Hand-actuated fasteners are generally more easily operated as the grip area increases. The relationship between fastener head size, hand torque capabilities, and crewmember restraint is shown in Figure 9.11-1 and Figure 9.11-2. The effect of grip surface area on the torquing capability of the weakest (fifth percentile) male is shown in Figure 9.11-3. Torquing capability data for the female needs to be developed. American female upper-body strength is generally considered to be from half to two-thirds that of the American male equal percentile.

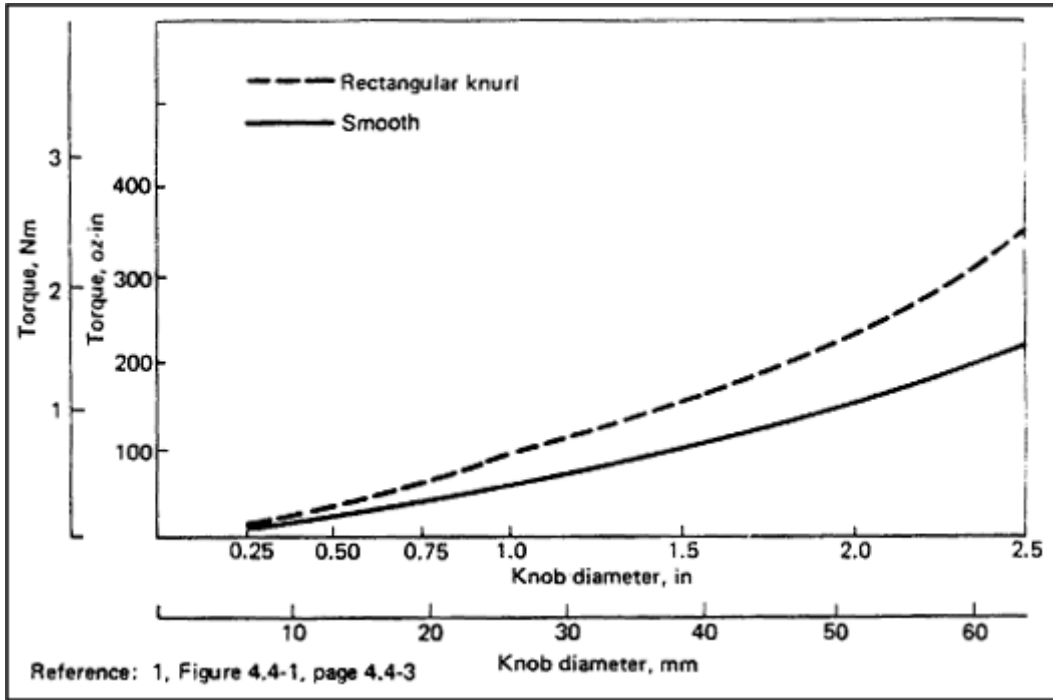


Figure 9.11-1 Hand torque capabilities when restrained by both feet, both feet and pelvis, or both feet and one hand (IVA). (MSFC-STD-512A, 1976)

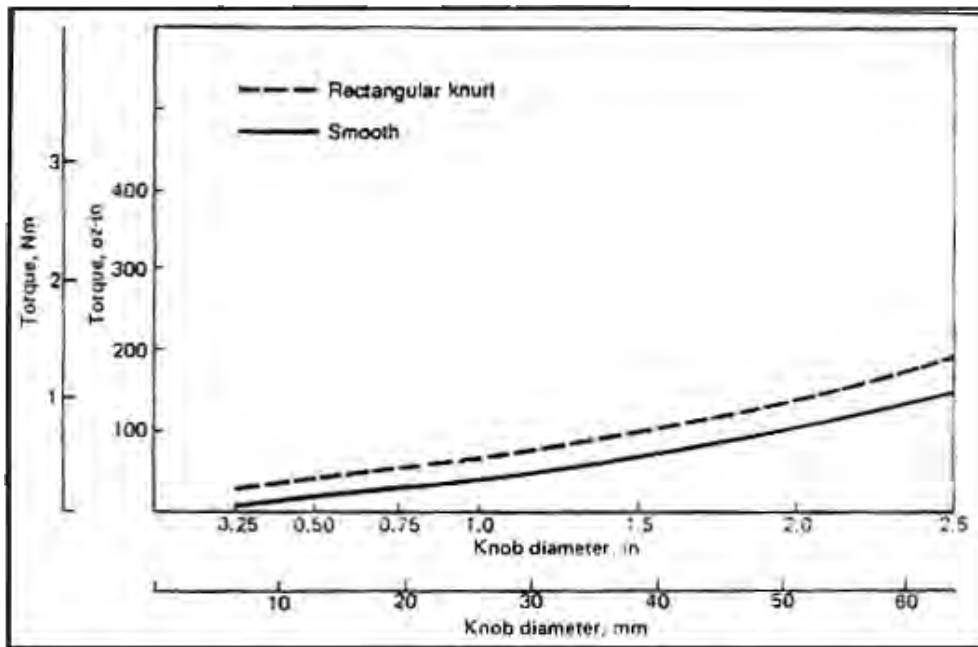


Figure 9.11-2 Hand torque capabilities when restrained by one hand (IVA). (MSFC-STD-512A, 1976)




Knob diameter		Rim Surface					
		Rectangular knurl		Diamond knurl		Smooth	
							
cm	in.	Ncm	lb-in.	Ncm	lb-in.	Ncm	lb-in.
0.3	1/8	2.3	0.2	3.4	0.3	0.3	0.03
0.6	1/4	8.8	0.6	7.9	0.7	2.3	0.2
1.0	3/8	11.3	1.0	12.4	1.1	4.5	0.4
1.3	1/2	14.7	1.3	17.0	1.5	6.8	0.5
1.6	5/8	22.6	2.0	20.3	1.8	9.0	0.8
1.9	3/4	27.1	2.4	27.1	2.4	15.8	1.4
2.2	7/8	32.8	2.9	32.8	2.9	15.8	1.4
2.5	1	45.2	4.0	40.7	3.6	17.0	1.5
3.2	1-1/4	44.1	3.9	49.7	4.4	22.6	2.0
3.8	1-1/2	63.3	5.6	59.9	5.3	38.4	3.4
4.4	1-3/4	81.4	7.2	83.6	7.4	42.9	3.8
5.1	2	97.2	8.6	91.5	8.1	50.9	4.5
5.7	2-1/4	116	10.3	116	10.3	71.2	6.3
6.4	2-1/2	140	12.4	131	11.6	93.8	8.3
7.0	2-3/4	174	15.4	173	15.3	88.1	7.8
7.6	3	181	16.0	179	15.8	94.9	8.4
8.9	3-1/2	220	19.5	244	21.6	147	13.0
10.2	4	280	24.8	290	25.7	164	14.5
11.4	4-1/2	320	28.3	330	29.2	208	18.4
12.7	5	380	33.6	392	33.8	244	21.6

Figure 9.11-3 Torque by knob size (values for 5th-percentile male). (MSFC-STD-512A, 1976).

9.11.2.2 Tool-Actuated Fasteners

In addition to the general fastener design guidelines, the following tool-actuated fastener guidelines apply:

- Nonstandard Tools – Fasteners requiring nonstandard tools should be avoided.
- High-Torque Fasteners (IVA Only) – External hex or external double-hex fastener heads are preferred and should be provided on all machine screws, bolts, or other fasteners requiring more than 14 Nm (10 ft-lbs) of torque. Internal wrenching fasteners should be Allen-head-type fasteners.
- Low-Torque Fasteners
 - Hex-type internal grip head, hex-type external grip head, or combination-head (hex or straight-slot internal grip and hex-type external grip head) fasteners should be used where less than 14 Nm (10 ft-lb) of torque is required.

- Internal-grip head fasteners should be provided only where a straight or convex smooth surface is required.
- Straight-slot or Phillips-type internal grip fasteners should be avoided.
- Precision Torquing – When possible, precise torque on fasteners should not be required. Where precise torque or preload is required, fasteners that incorporate torque-indicating features or that will mate with appropriate onboard torquing tools should be used.
- Torque Labeling – When fastener torquing to specifications is required, an instructional label should be provided in reasonable proximity to the fasteners.
- Number of Turns – When machine screws or bolts are required, the number of turns and the amount of torque should be no more than necessary to provide the required strength.
- Fastener Head Length – Fastener heads should be as short as possible so they will not snag personnel clothing or equipment.
- Left-Hand Threads – Left-hand threads should not be used unless system requirements demand them; then identify both the bolts and nuts clearly by use of markings, shape, color, etc.
- Locking – Threaded fasteners should incorporate features that allow them to be locked so that they will not unthread without using a tool.
- Hand-Tool Operable – All fasteners installed with power tools should be removable with a hand-operated tool.
- Tool-Actuated Fastener Head Types – In addition to the general tool-actuated fastener design considerations, the following IVA-specific tool-actuated fastener selection considerations apply:
 - Fastener heads directly exposed to the crew must be free of burrs, edges, and sharp corners, or be provided with protective covers, or be flush with the surface.

9.11.3 Packaging

Hardware and equipment such as consumables, spare parts, and specimens for experiments may require a protection not provided by a stowage system. Any additional packaging needs to be designed to be compatible with the planned stowage system, trash system, and inventory management system.

9.11.3.1 Packaging Design

The following packaging design guidelines apply:

- Sizing – Package size should be determined by taking into account the rate of use of the contents, the ease of handling, and the size of the processing equipment with which the package interfaces.
- Packaging Restraint – In 0g, a means should be provided for physically attaching or restraining a package at all locations where the package may have to be temporarily placed during use.
- Opening and Closing – Package design should accommodate opening and closing (if to be reused) tasks. Consider the conditions in which these tasks will be done: bare-handed or with gloves, emergency or normal operations, in lighted or dark conditions.

- Opening and Closing Hazards – Pull-tabs, lids, and other easy-opening features of packaging should be selected to avoid crew injury during normal use of the feature.
- Package Identification – Package contents should be identifiable on the outside of the package. Labeling is required and, if possible, the contents should be visible. The labels must be visible when the packages are in their stowed position. For “dispensing” packages, the content level should be discernible without opening the package. In 0g, package weight cannot be used to judge content level.
- Package Disposal or Reuse – Packaging designers should consider what happens when the contents are removed from the package. Disposable packaging should be minimized. Reusable packaging should be durable to withstand repeated opening and closing actions. Ziploc bags used onboard the ISS for small items tended to tear and the equivalent Russian-provided bags seemed to be indestructible (OpsHab, 2008).

9.11.4 Research Needs

RESERVED

9.12 SAFETY HAZARDS

9.12.1 Introduction

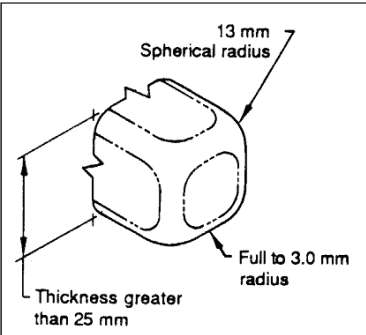
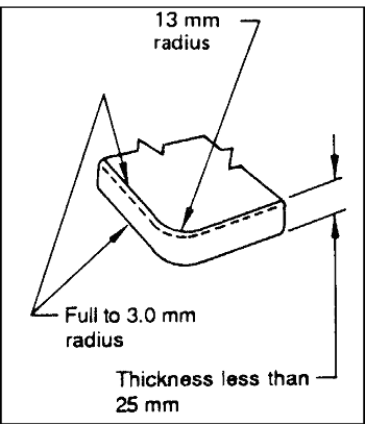
When designing hardware for nominal operations as well as for maintenance and repair, the safety of the crew is a critical factor. This section discusses potential hazards to the crew created by systems hardware and equipment and include mechanical, thermal, electric shock, and fire hazards.

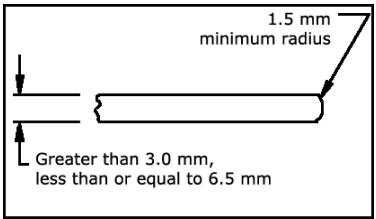
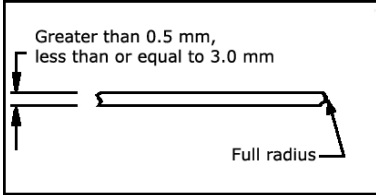
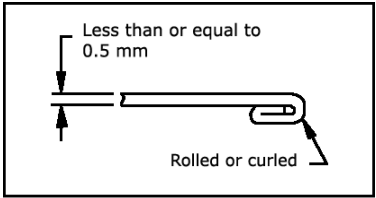
9.12.2 Mechanical Hazards

9.12.2.1 Sharp Edges

To prevent injury and damage to protective equipment, corners and edges to which the crew could be exposed must be rounded as specified in Table 9.12-1. Sharp edges on equipment have the potential to cause injury, as well as damage to equipment such as spacesuits. Rounding of corners and edges helps to prevent injury to personnel and damage to protective equipment.

Table 9.12-1 Corners and Edges

Material Thickness, t	Minimum Corner Radius	Minimum Edge Radius	Figure
t > 25 mm (t > 1 in.)	13 mm (0.5 in. (spherical))	3.0 mm (0.120 in.)	
6.5 mm < t ≤ 25 mm (0.25 in. < t ≤ 1 in.)	13 mm (0.5 in.)	3.0 mm (0.125 in.)	

Material Thickness, t	Minimum Corner Radius	Minimum Edge Radius	Figure
3.0 mm < t ≤ 6.5 mm (0.125 in. < t ≤ 0.25 in.)	6.5 mm (0.26 in.)	1.5 mm (0.06 in.)	
0.5 mm < t ≤ 3.0 mm (0.02 in. < t ≤ 0.125 in.)	6.5 mm (0.26 in.)	Full radius	
t < 0.5 mm (t < 0.02 in.)	6.5 mm (0.26 in.)	Rolled, curled, or covered to 3.0 mm (0.120 in.)	

Items with functional sharp edges, such as scissors, needles, and razor blades, will exceed the limits in Table 9.12-1 by necessity, but methods of protecting the crew such as covers and proper stowage containers must be provided. The method to be used to provide protection should be determined on a case-by-case basis.

Corners and edges of systems, which are accessed infrequently such as during maintenance, may exceed the limits in Table 9.12-1, but must be rounded to at least 0.01 in.

9.12.2.2 Loose Equipment

Corners and edges of loose equipment must be rounded to radii no less than those given in Table 9.12-2. Equipment that can become loose may become a projectile in flight. The more massive an object, the more damage can be done with a given corner/edge radius. Therefore, the greater the mass, the larger the radius of corners and edges.

Table 9.12-2 Loose Equipment Corners and Edges

Equipment Mass		Minimum Edge Radius mm (in.)	Minimum Corner Radius mm (in.)
At Least kg (lb)	Less Than kg (lb)		
0.0 (0.0)	0.25 (0.6)	0.3 (0.01)	0.5 (0.02)
0.25 (0.6)	0.5 (1.1)	0.8 (0.03)	1.5 (0.06)

Equipment Mass		Minimum Edge Radius mm (in.)	Minimum Corner Radius mm (in.)
At Least kg (lb)	Less Than kg (lb)		
0.5 (1.1)	3.0 (6.6)	1.5 (0.06)	3.5 (0.14)
3.0 (6.6)	15.0 (33.1)	3.5 (0.14)	7.0 (0.3)
15.0 (33.1)	--	3.5 (0.14)	13.0 (0.5)

9.12.2.3 Entrapment

To ensure that systems and equipment do not entrap suited or unsuited fingers, round or slotted holes that are uncovered must be less than 1.02 cm (0.4 in.) or greater than 3.56 cm (1.4 in.) in diameter for systems and equipment located inside habitable volumes

9.12.2.4 Burrs

Exposed surfaces must be free of burrs. Burrs should be removed from as-built surfaces during the manufacturing phase. Manufacturing processes can leave burrs on exposed surfaces, which cannot be prevented in design. Possible injuries from burrs include cuts, scrapes, and fabric tears that could create problems critical to a mission.

9.12.2.5 Pinch Points

Pinch points must be covered or otherwise prevented from causing injury to the crew. Pinch points could be present with latches, hinges, and other mechanisms.

9.12.3 Thermal Hazards

Exposure to either extreme heat or extreme cold, from whole-body exposure or contact with hot or cold surfaces, can be dangerous to crewmembers. Exposure to extreme environmental temperatures can affect body core temperature, resulting in hypothermia and hyperthermia, and even death. Environmental thermal exposure is discussed in section 6.2 Internal Atmosphere. However, hot or cold surfaces can be safety hazards because of the risk of incidental touch exposure to them; either type of surface may cause damage to the skin. Since the sensation of the temperature of an object depends on the type of material that is touched, and in some cases on perception of injury by the human, a specific temperature range for acceptable touch temperature cannot be given for all materials. The thermal properties of the given material and duration of exposure should be considered.

9.12.3.1 High Temperature

Any surface to which the bare skin of the crew is exposed must not cause epidermis/dermis interface temperature to exceed the pain threshold limit of 44°C. Research by Greene et al., (1958) on human tolerance to heat pain showed that the pain threshold is reached at 43.7°C skin temperature. Lloyd-Smith and Mendelssohn (1948) found the pain threshold to be 44.6°C. Defrin et al. (2006) investigated heat pain threshold across the body and found the lowest level in

the chest (42°C), the highest in the foot (44.5°C) and the hand was 43.8°C. Moritz & Henriques (1947) found that:

- 1) 44°C is the lowest temperature at which significant epidermal damage occurs, after exposure is sustained for 6 hours.
- 2) As the contact temperature increases above 44°C, the time to damage is shortened by approximately 50% for each 1°C rise in temperature, up to about 51°C.
- 3) Increasing contact pressure was not sufficient to increase the risk of thermal injury.
- 4) At contact skin temperatures above 70°C, it takes less than 1 second to produce complete epidermal cell death.

It is important to stress that these temperatures refer to the surface temperature of the skin, and not objects in contact with the skin. Depending on their material properties, objects with higher surface temperatures may not provide sufficient heat transfer to raise the skin to the same temperature.

Studies by Stoll et al. (1979) on human tolerance to pain from contact of bare skin with materials at various high temperatures, for contact times ranging from 1 to 5 seconds, have shown that pain threshold can be fit to a curve described in the equation below:

$$T_o = YI [(k\rho c)_o^{-1/2} + 31.5] + 41$$

where

T_o = object temperature (°C)

YI = antilog [$YII(aI) + \log YIII$] $YII = 1.094(t) - 0.184$

$YIII = 0.490(t) - 0.412$

$(k\rho c)_o$ = thermal inertia of contact material (cal²/cm⁴•°C²•s)

k = coefficient of heat transfer, ρ = density, and c = specific heat

aI = epidermal thickness, in mm (average 0.25 mm)

t = time of exposure, in seconds (time of exposure is limited to 1 to 5 seconds)

For contact time beyond 5 seconds, Hatton and Halfdanarson (1982) found that a semi-infinite model correlated well with Stoll's data using a contact conductance of 1,000 W/m²K. Solving the one-dimensional semi-infinite model with contact conductance for object temperature, assuming initial skin temperature of 32.5°C, epidermis thickness of 0.25 mm, skin inverse square root of thermal inertia of 27.96 cal²/cm⁴°Csec), skin thermal conductivity of 0.54 W/m•K, and maximum dermis/epidermis temperature of 44°C, yields the equation and constants given below for contact duration greater than 5 seconds. This method is only valid for thick, single materials. Problems involving layers of materials (layups) may require the use of thermal models.

For skin contact duration > 5 seconds:

$$T_{PM} = \frac{a}{(\sqrt{k\rho c_p})_{object}} + b$$

where:

T_{PM} = object permissible material temperature (°C)
 $(k\rho c)_{\text{object}}$ = object thermal inertia ($\text{cal}^2/\text{cm}^4\text{C}^2 \text{ sec}$)
 a, b = equation constants

Calculation and verification of permissible hot temperatures should take into consideration whether contact with the object will be incidental (unintentional) or intentional (planned). When calculating T_{PM} for intentional contact, a minimum time of 10 seconds applies. Where contact time for nominal operations is planned to exceed 10 seconds, time increments for up to 30 seconds, up to 60 seconds, or infinite time are to be used. Because contact time is a factor in establishing permissible material temperature, consider the following if there is potential for exceeding planned contact time:

- either calculate T_{PM} using higher or infinite contact time, especially if there may be an adverse consequence due to unplanned release of an object;
- or, inform crewmembers of the contact time limit via an operational control that has been coordinated with the operations community.

Calculation of allowable contact time for a given material at a particular temperature is discouraged. Operationally, it is impractical for crewmembers to accurately keep track of variable contact times while performing tasks.

The equation for T_{PM} assumes the object material is homogeneous. If the object is a layup of different materials (i.e., is comprised of layers), T_{PM} is to be calculated using the thermophysical properties of the material with the lowest value for inverse thermal inertia. Alternately, with justification, T_{PM} may be calculated using the thermophysical properties of the material in the layup that is the largest contributor to the change in skin temperature, or using thermal models. Figure 9.12-1 illustrates hot T_{PM} for incidental and intentional (planned) contact times and four common materials.

1. For incidental contact, defined as contact time $t \leq 1$ second:

$$T_{PM} (\text{°C}) = a * (k\rho c)^{-1/2} + b$$

Where:

$(k\rho c)^{-1/2}$ = inverse thermal inertia of material ($\text{cm}^2 \text{ °C sec}^{1/2}$)/cal (sample values are in Table 9.12-3)

a = 0.92

b = 69.97

2. For intentional contact, defined as planned skin contact for any length of time:

$$T_{PM} (\text{°C}) = a * (k\rho c)^{-1/2} + b$$

Where:

$(k\rho c)^{-1/2}$ = inverse thermal inertia of material ($\text{cm}^2 \text{ °C sec}^{1/2}$)/cal (sample values are in Table 9.12-3)

a, b = constants in Table 9.12-4 Hot Temperature Constants for Intentional Contact

Table 9.12-3 Inverse Thermal Inertia for Commonly Used Materials

Material	Inverse Thermal Inertia $(k\rho c)^{-1/2}$ ((cm ² °C sec ^{1/2})/cal)
Aluminum (6061T-6)	2.2
316 Stainless Steel	5.9
Glass	28.8
Teflon	57.5
Nylon Hook Velcro	586 (effective)
k = thermal conductivity, ρ = density, c = specific heat	

The effective thermal inertia of materials, such as Velcro, that are not solid throughout need to be calculated conservatively using the material thermal inertia divided by an estimate of the fraction of material versus air contacting the skin. For example, the product $k\rho c$ for Nylon 66 is 0.000266 cal²/cm⁴•C²•s, but the fraction of hook material is 1.09%. Therefore, the equivalent value of $k\rho c$ for hook Velcro is 2.9×10^{-6} cal²/cm⁴•C²•s.

Table 9.12-4 Hot Temperature Constants for Intentional Contact

Contact Time (s)	a	b
10	0.48	50.07
30	0.46	46.61
60	0.45	45.90
∞	0.42	44.87
Note: when calculating T _{PM} for intentional contact, use constants for planned contact times up to 10 s, 30 s, 60 s, or infinite time, as appropriate.		

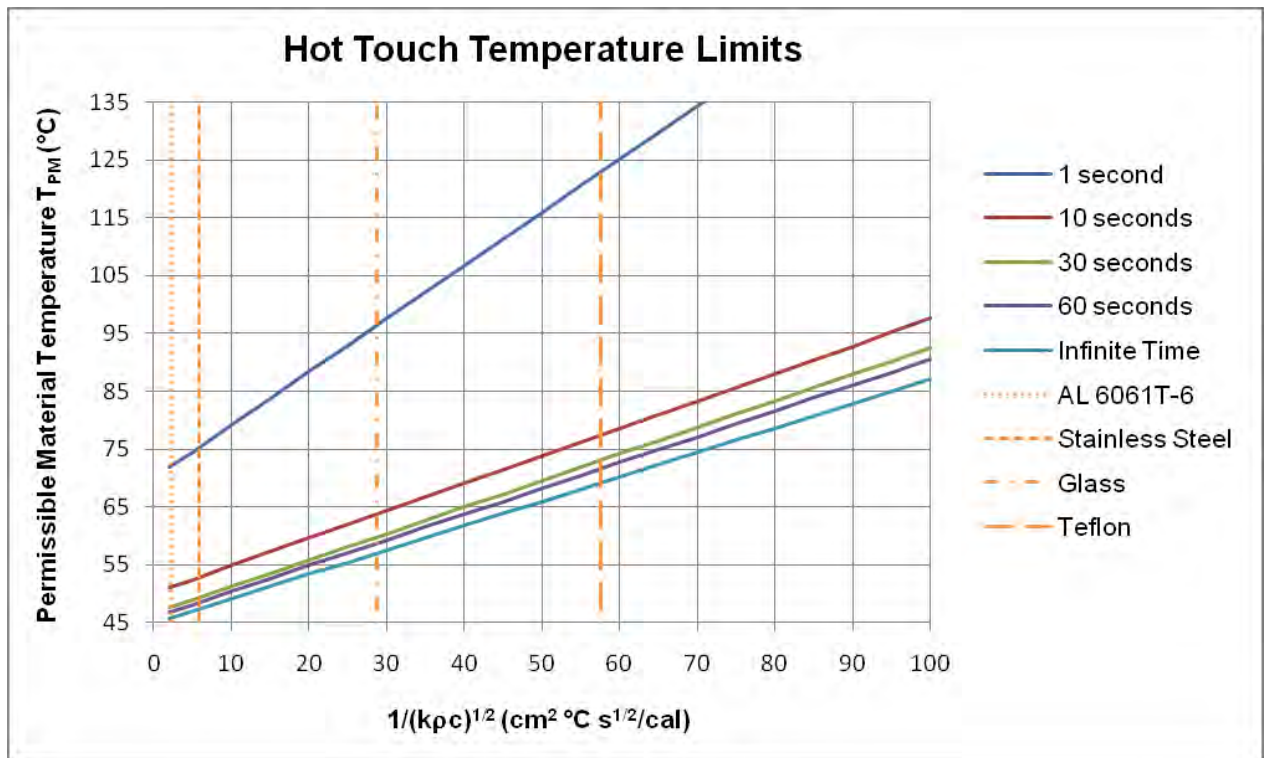


Figure 9.12-1 Hot T_{PM} for incidental and intentional (planned) contact.

Thermal models can allow more exact calculation of permissible touch temperatures for thermally thin homogeneous material objects. The resulting allowable temperatures will be higher than those calculated using the above method. If a thermal model is used for verification, the method of Hattan and Halfdanarson (1982) is used. That is, it must meet the following conditions:

- One-dimensional semi-infinite skin model using
 - thermal conductivity of 0.54 W/mK
 - thermal diffusivity of 1.3×10^{-7} m²/s (combined with the thermal conductivity, this yields an inverse square root of thermal inertia of 27.96 cal²/cm⁴°C sec
 - density of 1200 kg/m³ if required (modeling software may require the density and heat capacity of the skin as inputs – if this is the case, use this density and the value of thermal diffusivity to calculate the specific heat), the exact value of density (and specific heat) do not affect the result
 - Epidermal thickness of 0.25 mm
- Contact conductance of 1000 W/m²K
- One-dimensional finite model of the object using appropriate material properties and thicknesses

9.12.3.2 Low Temperatures

Research has shown that as finger skin temperature drops, due to contact (< 2 minutes) with a cold object, the following occur (Geng et al., 2006):

<u>Finger Skin Temperature</u>	<u>Effect</u>
15°C	Pain
7°C	Numbness
0°C	Risk of Frostbite

Contact force did not significantly contribute to the ability to predict the temperature at which each effect occurred.

Pain threshold, versus damage threshold, should be used to a) preclude skin damage, and b) prevent a startle pain reaction (i.e. pulling a hand away quickly), which may cause injury to due flail. In addition, staying above the numbness threshold is important, since numbness may mask skin damage.

Very little other data exists in the literature for cold touch temperature. Geng et al., (2006) developed some data which was used to create ISO 13732-3: Ergonomics of the thermal environment – Methods for the assessment of human responses to contact with surfaces, Part 3: Cold Surfaces. However, there are only curves of time and allowable temperature for specific materials: aluminum, stainless steel, Nylon, stone and wood. Instead, this data was used to develop a generalized cold touch temperature curve (and resulting equation and constants) for any material, given indefinite contact time is allowed for Nylon at 0°C (Geng et al., 2006) and for a material with infinite thermal conduction at 15°C. This method is only valid for thick, single materials. Problems involving layers of materials (layups) may require the use of thermal models.

For the NASA cold touch temperature standard, a 10°C skin temperature limit was determined to be acceptable using the results of human testing of space suit glove thermal performance. The tests of subjects with normal healthy skin showed that an externally measured hand skin temperature of 10°C (50°F) was tolerable (JSC 39116, EMU Phase VI Glove Thermal Vacuum Test and Analysis Final Report), so this was taken as the skin temperature limit. This limit maximizes the allowable material temperature envelope while avoiding the risk of numbness.

Calculation and verification of permissible cold temperatures should take into consideration whether contact with the object will be incidental (unintentional) or intentional (planned). A minimum time of 10 seconds applies when calculating T_{PM} for intentional contact. Where contact time for nominal operations is planned to exceed 10 seconds, time increments for up to 30 seconds, up to 60 seconds, or infinite time are to be used. Because contact time is a factor in establishing permissible material temperature, consider the following if there is potential for exceeding planned contact time:

- either calculate T_{PM} using higher or infinite contact time, especially if there may be an adverse consequence due to unplanned release of an object;
- or, inform crewmembers of the contact time limit via an operational control that has been coordinated with the Operations community.

Calculation of allowable contact time for a given material at a particular temperature is discouraged. Operationally, it is impractical for crew to accurately keep track of variable contact times while performing tasks.

The equation for T_{PM} assumes the object material is homogeneous. If the object is a layup of different materials (i.e., is comprised of layers), T_{PM} is to be calculated using the thermophysical properties of the material with lowest value for inverse thermal inertia. Alternately, with justification, T_{PM} may be calculated using the thermophysical properties of the material in the layup that is the largest contributor to the change in skin temperature, or using thermal models. Figure 9.12-2 illustrates cold T_{PM} for incidental and intentional (planned) contact times and four common materials.

1. For incidental contact, defined as contact time $t \leq 1$ second:

$$T_{PM} (\text{°C}) = a * (k\rho c)^{-1/2} + b$$

Where:

$(k\rho c)^{-1/2}$ = inverse thermal inertia of material ($\text{cm}^2 \text{°C sec}^{1/2}$)/cal (sample values are in Table 9.12-3)

a, b = constants in Table 9.12-5 Cold Temperature Constants for Incidental Contact

2. For intentional contact, defined as planned skin contact for any length of time:

$$T_{PM} (\text{°C}) = a * (k\rho c)^{-1/2} + b$$

Where:

$(k\rho c)^{-1/2}$ = inverse thermal inertia of material ($\text{cm}^2 \text{°C sec}^{1/2}$)/cal (sample values are in Table 9.12-3)

a, b = constants in Table 9.12-6 Cold Temperature Constants for Intentional Contact

Table 9.12-5 Cold Temperature Constants for Incidental Contact

time (s)	$(k\rho c)^{-1/2}$	a	b
1	≤ 43.5	-1.16	0
	> 43.5	-0.88	-12.29

Table 9.12-6 Cold Temperature Constants for Intentional Contact

time (s)	a	b
10	-0.71	4.78
30	-0.62	9.51
60	-0.53	10.00
∞	-0.37	10.00

Note: when calculating T_{PM} for intentional contact, use constants for planned contact times up to 10 s, 30 s, 60 s, or infinite time, as appropriate.

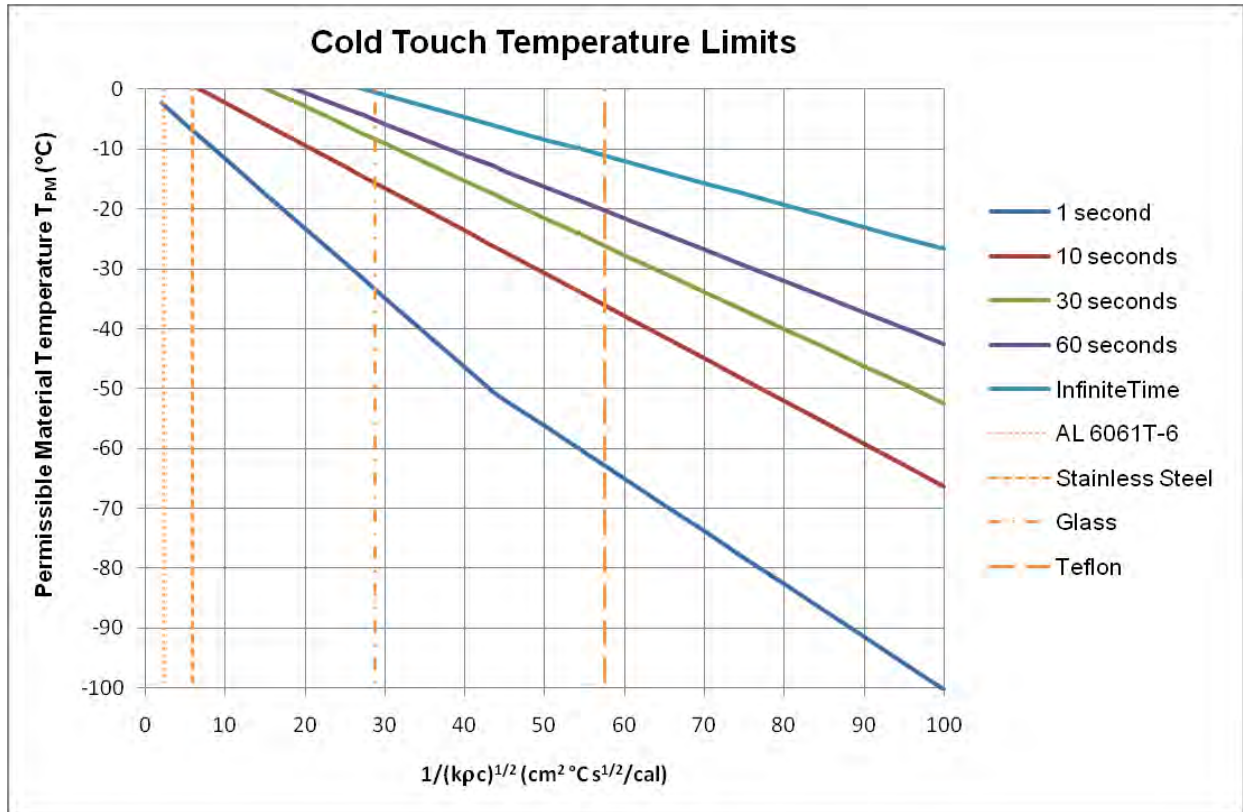


Figure 9.12-2 Cold TPM for incidental and intentional (planned) contact.

9.12.4 Electrical Hazards

Injurious physiological effects of the passage of electric current through the human body include stoppage of breathing, ventricular fibrillation of the heart, electric burns, paralysis, and even death.

The International Electrotechnical Commission (IEC) is the world’s leading organization for international standards. IEC 60479 is composed of five separate documents – three technical specifications and two technical reports. The document referenced in NASA-STD-3001 (IEC 60479-5 “Technical Report: Effects of Current on Human Beings and Livestock – Part 5: Touch Voltage Threshold Values for Physiological Effects”) is not a standard but rather is a technical report intended to provide guidance in establishing safety standards.

IEC TR 60479-5 provides voltage threshold limits that are based on current limits (see IEC TR 60479-5 Table 1) as specified in IEC TS 60479-1, “Technical Specification: Effects of Current on Human Beings and Livestock”. Although current is normally used in electrical safety standards, voltage is typically an easier parameter to measure than micro-amps since no special

equipment is required. This also allows designers to determine whether hazard conditions exist based solely on voltage levels that may be present on conductive surfaces.

The voltage limits in IEC TR 60479-5 show considerable variation and overlap between groupings. For example, startle reaction can occur at DC voltages ranging from 1 to 78 volts depending on conditions (see IEC TR 60479-5 Table 2d). However, NASA has traditionally considered 32 volts root-mean-square (VRMS) to be the threshold for a catastrophic hazard. Therefore, to be consistent with previous NASA considerations, 9.3.2.3 [V2 9019] specifies a maximum exposure voltage of 32 VRMS.

The requirements in 9.3.2.3 [V2 9019] and 9.3.2.4 [V2 9020] are general requirements that apply to all types of powered equipment regardless of their intended use. The leakage current requirements in 9.3.2.5 [V2 9023] are applicable only to equipment that is intended to directly contact the human body. This includes equipment designed for medical use, exercise, experiments/research, as well as other personal flight crew equipment.

9.12.4.1 Methods of Reducing Risk of Shock

Preventing shock from exposure to hazardous voltages and currents is primarily accomplished by:

Controlling physical access

- Barriers/Panels

Electrical design

- Providing a low resistance (< 0.1 ohms) return current path to ground by proper bonding
- Verifying isolation of voltage sources (> 1 megohm) from exposed surfaces of equipment
- Interrupting current using fuses/circuit breakers
- Providing a redundant path for return current using a safety (green) wire
- Using proper connectors (see Section 9.6)
- Ensuring that there are no “floating” connectors on cables

Operational controls

- Removing or inhibiting the voltage source through procedures
- Providing warning signs
- Using proper tools and personal protective equipment during operation and maintenance

Even with good design, some current may be passed through the body from contact with equipment. Such current is referred to as “leakage current” and must be kept at low levels. During the analysis, consider how faults within the equipment might affect voltages on any exposed surfaces. Also consider how the equipment will be used (the operating environment): Will it be used in the presence of any fluids? Could the operator be under stress (or sweating) while using the equipment? What other equipment might be around the operator during use? It is very important to work with the safety representative for the program of interest in assessing all plausible hazard scenarios, determining the worst-case effect that can be accepted (i.e., startle

response or strong muscular reaction), and the number of controls required to mitigate the hazard.

It is important to clarify what is needed regarding chassis leak current in program documentation. The Constellation Program defined chassis leakage current as applicable to both portable equipment and fixed equipment that has exposed conductive surfaces not directly chassis bonded to a conductive reference structure. In other words, the non-bonded hardware behaves like portable equipment, but it is hard mounted. This occurs when equipment must be mounted (i.e., integrated boxes [not portable]), but there is not a referenced conductive surface available (i.e., non-conductive composite structure mounted).

9.12.4.2 Effects of Electrical Shock

The response of the human body to electrical current being conducted through the body following exposure to a voltage source is dependent on a number of factors including: the magnitude of the voltage, duration of contact, frequency of the voltage, the impedance of the body, and the current pathway. Responses at lower voltages can range from a slight tingling sensation to ventricular fibrillation of the heart and stoppage of breathing, as indicated in the following table for 60 Hz. In addition, higher voltages and currents can result in burns due to thermal trauma and electroporation.

Table 9.12-7 Physiological Effects of Electric Shock (60 Hz)

Current Level mA (rms)	Effect				
	Sensation	Muscle Reaction	Cardiac Reaction	Thermal Effect	Electroporation (EP)
1 – 10	Perception Discomfort Pain Intolerable pain	Twitch			
10 – 100		Grip tetanus Respiratory interference Respiratory tetanus		$\Delta T = 1\text{ }^{\circ}\text{C}$	Reversible EP
100-1000			Excitation Fibrillation	$\Delta T = 45 - 70\text{ }^{\circ}\text{C}$	Irreversible EP
> 1000			Defibrillation		

Note: Table adapted from: Applied Bioelectricity, J. Patrick Reilly

In addition to the primary physiological effects, an indirect electrical hazards such as fire, molten metal, and blinding flashes can occur as a result of short-circuit arcing. Involuntary muscle contractions can propel operators into adjacent equipment, which might also cause harm. Although the “startle response” occurs at lower current amplitudes than those normally associated with physiological effects, the hazard criticality could be just as great depending on the situation. For example, if a crewmember in the middle of an EVA perceives the he or she is being shocked, the result might be a violent reaction that could jeopardize the mission. Design must prevent generation of these indirect hazards or protection of the crew in case of such an occurrence.

The limits in IEC 60479-5 apply specifically to direct current or alternating current at 50/60 Hz. The risk of electrical shock from current on the body changes as a function of frequency. In

general, all other factors being equal, the risk for involuntary muscular stimulation, inability to let go, and ventricular fibrillation decreases for frequencies less than 10 Hz and for frequencies greater than 100 Hz. Therefore, an analysis using values developed for 50/60 Hz might be considered a worst-case analysis, at least for sine waves.

As frequency increases, the physiological effects change from muscle stimulation effects to tissue heating effects (burns). As frequency increases past 10 kHz, the hazard is related to tissue heating and radiation effects. Radiation hazards are covered in NASA-STD-3001, Volume 2, Section 6.8.

9.12.4.3 Examples of How to Use IEC TR 60479-5 for Electrical Safety Analysis

Example 1

A device for collecting experiment data is being developed for a program. The device will use a USB connector to transfer data to a laptop. It is possible that the device will be powered on when the USB cable is connected. Common sense would dictate that since USB operates at 5 VDC and reports of shock by USB are rare, that there is minimal risk. This can also be verified quickly by the tables in IEC TR 60479-5. Looking at IEC TR 60479-5 Tables 2d and 2e, it is evident that for a small contact area (1 cm²) and a hand-to-seat current path (worst case), the lowest voltage that could produce even a startle response is 6 VDC. This would also assume that the crewmember is sweating heavily (saltwater-wet) and manages to contact the USB connector pins while making contact with ground for 10 seconds or more.

Even though the USB standard allows for a maximum current of 500 – 900 mA, the body provides enough resistance under these conditions to limit the current to less than 2 mA (the DC threshold for startle). However, the design should still be assessed to make sure that no failures could produce a higher voltage on the connector.

Example 2

Due to spacecraft charging effects, the ISS truss structure can have a large potential relative to the surrounding plasma. Assume a component of the EMU can make contact with a point on the ISS at a relative potential of +15 V. A plausible current path is identified in the EMU that could generate a 20 milliamp, 6 millisecond pulse across the torso of a crewmember when contact is made. Assume a contact area of approximately 10 cm². Would this be considered a hazard? Following Figure 4 of IEC TR 60479-5, we will assume that the pulse is considered DC for the 6 millisecond duration. We also assume that the skin is in saltwater-wet condition. This is a worst-case assumption since the impedance of the body due to sweat is actually some value between water-wet and saltwater-wet. The contact area of 10 cm² is close to 12.5 cm², which leads us to use Figure 15 to determine the maximum time duration allowed. Because the pulse is applied across the torso, the internal body resistance can be calculated as approximately 50 ohms, giving a pulse amplitude of $(0.02 \times 50) = 1 \text{ V}$.

In this case, since the crewmember is in the EMU, a startle response could be considered a catastrophic hazard. From Figure 15, the voltage limit for a startle response is approximately 2 V, regardless of the duration of stimulation. Since the pulse amplitude is only 1 V, this would not be considered a hazard.

Example 3

A portable instrument includes a 28 VDC power supply. An analysis finds that a component failure could potentially place the 28 volts on an exposed part of the device that is not grounded. If the failure did occur, under what conditions could the device still be operated safely?

If startle reaction might be of concern during operation, then from IEC TR 60479-5 Table 2d, the only acceptable conditions would be for a small contact area (1 cm² – about the size of a fingertip) with either dry or water-wet skin conditions.

Let's assume that a startle reaction would not be considered a hazardous situation for this equipment, but a strong muscular reaction would. From Table 2e, any conditions with a limit less than 28 VDC would be not be acceptable from a safety standpoint. For a small contact area, there is minimal risk. For larger contact areas, it might be necessary to provide additional insulation or isolation.

Strong muscular effects	DC touch voltage thresholds for long duration V									
	Current threshold mA	Saltwater-wet			Water-wet			Dry		
		Large contact	Medium contact	Small contact	Large contact	Medium contact	Small contact	Large contact	Medium contact	Small contact
Hand-to-hand	25	24	44	112	29	81	156	43	89	156
Both-hands-to-feet	25	13	23	63	16	51	133	26	67	133
Hand-to-seat	25	12	22	56	15	41	78	21	45	78

Table 2e from IEC TR 60479-5

Notes

Values in Tables 2a – 2f represent long-duration exposures (> 10 seconds). Voltage-time curves (Figures 1 – 22) can be used to determine voltage limits for shorter-duration exposures.

Voltage limits are based on 5th percentile total body impedances from IEC TS 60479-1. These values of impedance are lower than for 95th percentile, giving a more conservative limit.

The asymptotic values of body impedance in Tables A.1 and A.2 represent the internal body resistance (i.e., the skin impedance is eliminated).

9.12.4.4 Estimating Human Body Impedance

In assessing potential electrical hazards, it may be necessary to estimate the impedance of the human body for certain scenarios. This can be challenging as it depends on many different factors such as the body location, contact area, frequency of the current, and presence of moisture/sweat. Figure 9.12-3 presents one model of internal body resistance between various points on the body, based on an internal hand-to-foot resistance of 1100 ohms. Negligible skin impedance is assumed for all current paths, thus providing a worst-case estimate. A general method of calculating body impedance can be found in Appendix A and B of IEC TR 60479-5. Note that skin impedance is included in these methods, although a worst-case analysis will typically assume zero skin impedance.

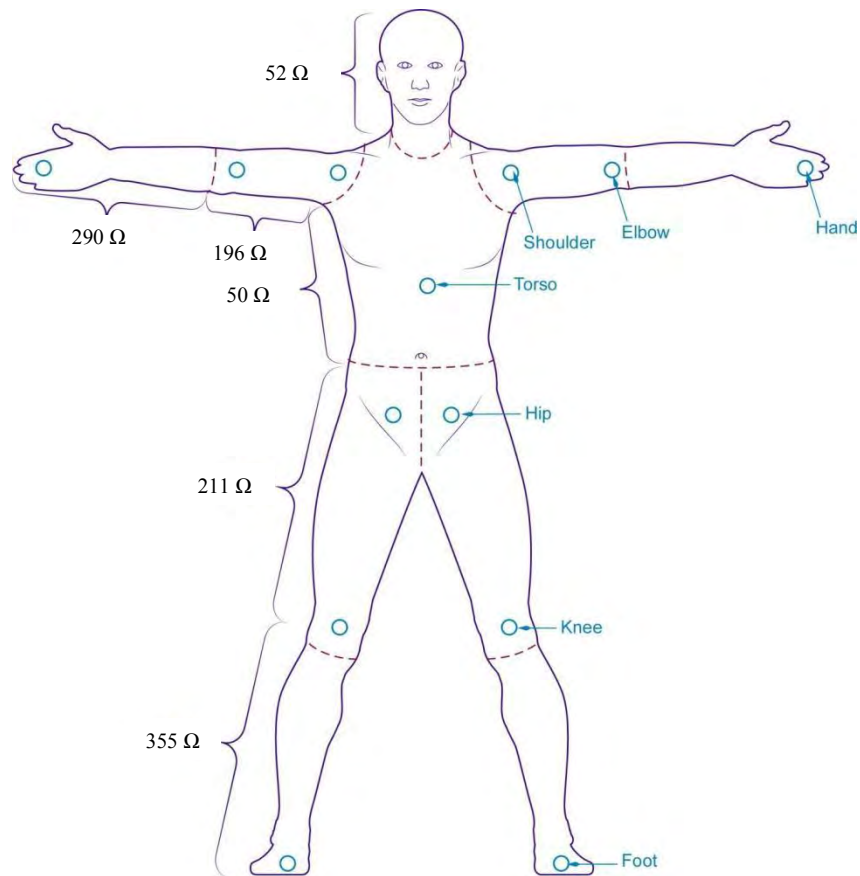


Figure 9.12-3 Internal human body resistance model.

Note: The skin resistance is assumed to be 0 Ω. The internal body resistance is concentrated about the joints.

9.12.4.5 Measurement Methods

A standard voltmeter can be used to verify that voltage on exposed parts of equipment do not exceed the limits established. The voltmeter should be able to give a true RMS reading. For non-sinusoidal waveforms, the peak value of the voltage should be used instead of the RMS value. For measuring leakage currents, the typical measuring circuit below can be used (Figure 9.12-4). The circuit automatically adjusts for frequency.

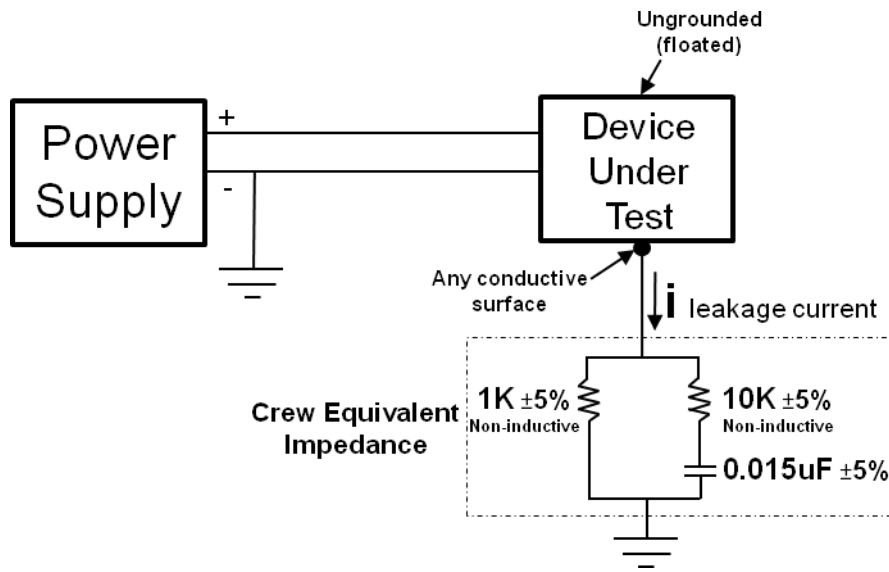


Figure 9.12-4 Typical measuring circuit.

For measuring leakage current on plastic surfaces, a piece of conductive foil should be placed on the enclosure. The foil should measure approximately 10 x 20 cm (to represent the size of a human hand), or otherwise as large as possible. If adhesive tape is used to secure the foil, the tape should be conductive. Copper foil with conductive adhesive on one side is available.

Measurements should be made with equipment on and off and in all possible operating modes.

9.12.4.6 Definitions

RMS (root mean square) voltage – Also known as “effective” voltage, RMS is the level of an alternating voltage that produces the same effect as a DC voltage of the same level. For a sine wave current such as 50/60 Hz, the RMS voltage is equal to 0.707 times the peak voltage. For example, the limit of 32 VRMS can be considered to be a maximum of 32 volts DC, but a maximum of 45.2 volts peak for an AC voltage.

Internal versus external body contact – Table 16 in Volume 2 provides leakage current limits for equipment designed for human contact. This primarily applies to medical equipment but could also include certain types of exercise equipment and/or research-based equipment. The limits are based on the type of contact the equipment makes with the body. Internal body contact refers to a situation where the normal skin impedance has been compromised or bypassed. This is applicable to equipment using electrodes to capture signals (needle or surface). Leakage current limits for medical equipment are also more restrictive than those for other types of equipment.

9.12.5 Research Needs

Electrical Hazards

- More research is needed to help improve models of human body impedance and further define physiological effects. A collaborative effort by NASA, the Naval Health Research Center Directed Energy Bio-Effects Laboratory, and other subject matter experts uses

computational models to calculate current densities impinging on various internal body structures, given voltage contact points on the skin. The model currently only considers two current pathways; however, the exposure voltage can be adjusted to examine the effect on internal current levels.

9.13 DESIGN FOR TRAINING

9.13.1 Introduction

This section discusses the integration of training considerations in hardware and system design. Designing a system for optimal trainability reduces the required training time and the likelihood that operator errors will result in increased life-cycle costs and greater risk.

9.13.2 Design with Training in Mind

All crew-vehicle systems will require crew training before flight. To ease learning and maximize training effectiveness and efficiency, consider the following principles of learning (Halpern & Hakel, 2003):

- Acquisition. The time needed for crewmembers to acquire a skill should be minimized, to accommodate the limited time available for training.
- Retrieval. Designs and training should optimize the user's ability to retrieve and use, in the appropriate context, what has been learned.
- Retention. The retention of skills should be maximized to last from the initial training to a future use.
- Transfer. The capability of transferring skills to new situations should be maximized. Training and simulation on Earth will be conducted in 1g, neutrally buoyant, or other environments (including parabolic flight and virtual reality). The design for training and simulations should be such that the transition from Earth to 0-g or partial-g environments does not significantly negate the benefits of this training. In addition, since the crew cannot be trained, in advance, for all situations eventually encountered, transfer of basic skills to such new situations must be optimized.

These goals can be achieved if training considerations are integrated early into system design. Traditionally, training programs are not developed until the design of a system has been completed, and then the training needs to adapt to it. It has also been assumed that because people are very adaptive, they can adapt to the system. As a result, there has been little incentive to design systems with training and operational needs in mind. The ISS crewmembers have emphasized the importance of skills-based training as opposed to task-based training.

Integrating training considerations into system design requires the following set of assumptions:

- Human-centered design can minimize the need of the human to adapt, significantly reduce the likelihood of error, and lead to considerable savings in training and procedure complexity.
- System designers are not necessarily a representative sample of the user population.
- Human factors experts add significant value to design teams through better human-centered design and early consideration of training and use.
- The cost of errors and of compensating for design "savings" through complex procedures, extended training, and longer time on task over the full life cycle of a system is much greater than the cost of integrating trainability into the initial design.

- Training experts should participate in the design process from its very beginning. (The idea of including trainers early in the design cycle of a new product to enhance learning is similar to including quality assurance experts early in the design cycle for testability.)

Training is optimized when the following considerations are applied during system design:

- Start with a careful and comprehensive analysis of the intended task and the intended user, including the user's existing knowledge and knowledge structures.
- Design the system so as to capitalize on what the intended users already know and their common knowledge structures (see example of the computer "desktop" metaphor for an operating system in section 9.13.3.2).
- Design the system to facilitate transfer across tasks by capitalizing on common skills needed that are shared by different tasks.
- Maximize consistency and standardization across systems and across subsystems.
- Consider carefully the potential trade-offs between ease of learning and ease of use.
- Consider carefully the potential trade-offs between the savings and the costs of automation.
- Watch out for claims about anything "intuitive." Base your design choices on careful studies.
- Consider carefully the potential trade-offs between similarity and differentiation.
- Consider the development of adaptive elements in your system (especially important for long-duration missions).
- Consider the integration of embedded training functions (especially important for long-duration missions). If selected, proceed with caution.
- Make sure you have a human factors expert on your team, and get that person to participate in every step of the design process.

9.13.3 Methods for Integrating Training into Design

9.13.3.1 Analyze the Task and Intended User

A careful and comprehensive analysis of the intended task and user should be completed. Tasks should be broken down into component steps relevant to the user's cognitive and physical actions and needs. The user's prior knowledge and skills should be analyzed and considered in the design of tasks and interfaces. Additionally, careful analysis of the intended users, their prior knowledge, their abilities, and their tasks is a prerequisite for good designs. "Intuitive" designs must be cautiously evaluated. The notion of what is intuitive for one person may be different for another person depending on his or her background and experiences, especially across different national cultures. Significant differences may also exist across generations, professions, and regions within a given country.

A design may be perfectly intuitive to the designer, yet that designer may not be representative of the intended user group. Consider this problem where "intuitiveness" goes beyond the interface. Autoflight systems have been designed by engineers to optimize the management of the aircraft's energy. Energy management is a fine way to think of aircraft control, but it is not a philosophy shared by many pilots. (Pilots who fly soaring planes and gliders often think in terms of energy management, but pilots of powered airplanes are not usually trained to think that way;

civilian autoflight systems were first introduced to the large heavy transport aircraft flown by airline companies.) Pilots often think in terms of aircraft behavior, rather than in terms of energy management. This difference between what seemed intuitive to the design engineers and what seems intuitive to the pilot has turned out to be very problematic.

A design can be “intuitive” when it builds on the understanding of the users, their prior experience, and their task. It is not intuitive just because “it felt right” to the designer; it is the result of a careful analysis.

9.13.3.2 User Knowledge and Knowledge Transfer

The system should be designed to capitalize on the intended users’ knowledge and their common knowledge structures. However, just because intended users have previous experience with similar systems, do not assume that they do not need training. It is possible that similar systems do not incorporate optimal designs, and that the new design provides significant improvements. Even if users have learned to compensate for poorly designed systems, that is not a justification for repeating that design in new systems.

A discussion of learning often includes the importance of transfer of knowledge, usually in the context of using in one domain what was learned in a different domain. For space operations, there is the additional critical importance of transferring what was learned on the ground to the actual operations in space, especially with the novel environment of 0g.

People learn best when new information can be mapped onto their existing knowledge. Additionally, people organize their knowledge around central concepts, or metaphors. For example, organizing computer functions along themes relevant to the user’s purpose is very helpful. In a word processing program, all editing functions are listed under the “Edit” menu, and all formatting functions are listed under the “Format” menu. However, such a design requires careful task analysis as well as an analysis of intended users’ previous knowledge.

The computer “desktop” metaphor is an example of a design that capitalizes on the way people organize their knowledge structures. Early personal computers required very abstract thinking and an abstract form of communication between the user and the interface. The graphical user interface of the Apple Macintosh (and earlier Xerox Star) with its icons of folders, documents, and a trash can allowed the users to map the metaphorical computer “desktop” onto their physical work desk, and thus easily learn how to manipulate the icons. Moreover, communicating with the interface through the point, click, and drag functions of the computer mouse eliminated the need for the abstract language of key combinations used on other computers of the time. All of these features made the Macintosh easy to learn, and were the result of a careful integration of user learning needs early in the design process.

9.13.3.3 Consistency and Standardization

Consistency and standardization should be maximized across systems and subsystems. The more similar different tasks are, the easier they are to learn. This is especially true once a first task is mastered. All subsequent tasks that are similar to this first task are much easier to learn than dissimilar tasks. This principle is particularly important for long-duration space missions when the retention interval between initial learning and subsequent use of the learned skill may be very long. However, a word of caution is in order: tasks that are very similar procedurally but are very different functionally could lead to confusion. As we have mentioned before, an optimal

trade-off must be achieved. In the context of spaceflight systems, desired similarity could take the form of consistent interface design, consistent terminology and nomenclature, and consistent form of interaction. One example is the use of the computer mouse to access all functions in all computer applications in the same way. Standardization and consistency across all systems and subsystems greatly enhance retrieval, in addition to supporting initial knowledge acquisition and transfer to other tasks. Retrieval refers to a person's ability to retrieve and use in the appropriate context that which has been learned and retained. Consistency enhances retrieval because the ability to retrieve a memory is a function of repetition: the more often a procedure is performed, the easier it is to remember and retrieve it. Consistency across interfaces means that the same procedure is used multiple times, and thus is more easily remembered and retrieved. (See section 10.2.3, Consistency, and section 10.2.2, Simplicity, for further discussion of relevant issues.)

9.13.3.4 Similarity versus Differentiation

The potential trade-offs between similarity and differentiation should be carefully considered. As stated before, the more similar different tasks are, the easier they are to learn. And tasks that are very similar procedurally but are very different functionally could lead to confusion. Sometimes, tasks with critical consequences are intentionally made inconsistent. This may be done to focus the attention of the user, not to confuse. Unintended consequences should be considered, and an optimal trade-off needs to be sought.

9.13.3.5 Ease of Learning versus Ease of Use

The potential trade-offs between ease of learning and ease of use should be considered. A system that is easy to use is not necessarily easy to learn. Ease of learning can be thought of in terms of minimizing the time required to master a skill, and ease of use as minimizing the likelihood of failure to accomplish a task.

The computer interface provides many examples illustrating the differences between the design for ease of learning and the design for ease of use. Different functions in a program, for instance, could be listed alphabetically, which would be very easy to learn. However, using such a list would be cumbersome if the user needs to scroll through the entire list each time it is used, regardless of the needed function. To make usability easier, functions are often grouped thematically. Although it may take longer to learn a thematic or hierarchical arrangement than an alphabetical listing, the initial training time investment likely pays off over the period of time using the program.

9.13.3.6 Automation

It has been argued often that the best way to reduce human error is to remove the human from the operation by increasing automation. This argument contains several serious flaws. First, the term "human error" has been often focused on operator error, but the operator is not the only human associated with the system. Although it's true that removing the operator reduces the likelihood of an operator error, it simply changes the locus of human error from the operator to the designer, the builder, or the maintainer of the system. Second, the human operator, although some time the source of an error, is much more often the source of system resilience through creative problem solving. And third, automated systems often increase system complexity, increase training needs, and make off-nominal situations very difficult to manage. The

requirement for manual backup and manual override options make automation a dubious design solution that should be approached with the utmost care, particularly in flight hardware and software for manned space operations.

9.13.3.7 Adaptive Systems and Embedded Training

Given the necessary tradeoffs between design for ease of use and design for ease of learning, an optimal system is an adaptive one that can recognize a user's level of knowledge and change accordingly. Current technology is not able to do that for hardware, but software-driven interfaces could be made adaptive. New ideas of reconfigurable hardware (e.g., the Optimus Maximus Keyboard of Art Lebedev Studio) are getting us closer to adaptive systems, but there is still a long way to go.

Embedded training refers to an operational system that can also be used for training, without interfering with current operations. For example, an airplane can be designed so it can be used as a simulator while it is being flown.

Embedded training can be very useful on long-duration space missions. Such an opportunity can be vital when the retention interval between training and performance is too long to maintain necessary proficiency, such as on a mission to Mars.

The possibility of embedded training needs to be evaluated and determined early in the design process. However, embedded training needs to be designed with extreme care and with multiple layers of defense against an inadvertent breach, activating the actual system instead of the training mode. An embedded training system can take advantage of existing hardware and software and override it for training. If the system is designed for redundancy, the embedded training system can take advantage of the redundant circuits and subsystems to perform training. While these methods may incur extra cost, it needs to be weighed against the cost of doing training in other ways, and the potential long-term effects of errors.

9.13.3.8 Performance Support Systems

Another form of a "training system" worth considering during the design phase is a "look over your shoulder" performance support system. This type of system contains a model of the tasks and procedures within the relevant domain; this model needs to be captured and created as part of the system specification and design phases. As the user is performing the tasks and activities, the performance support system monitors performance and compares it with the model. Such a system may be viewed as a type of embedded training, but it does not actually perform training. It is also not a simulation, but rather monitoring in real time and correcting, or at least restricting, what the operator is doing and what is available or allowable in light of the model.

9.13.3.9 Optimal Training

Defining a metric to measure optimal training is extremely difficult. It is easy to say that optimal training is that which yields the perfect skill for the maximum long-term retention in the minimum time and for the minimum cost. However, these four key parameters create a very complex set of tradeoffs.

- Level of performance
- Length of retention

- Training time
- Cost

It is common for a program to set a fixed training budget and schedule a priori in such a way that level of performance and length of retention are compromised. It is important to consider ways in which refresher training, just-in-time training, and in-flight practice could compensate for any initial compromises in performance level and length of retention. Particularly if the design is standardized and is consistent across tasks and subsystems, operating such subsystems can function as refresher training or practice for other subsystems.

9.13.4 Research Needs

RESERVED

9.14 REFERENCES

- AFSC DH 1-3. (1972). Human Factors Engineering. Air Force Systems Command, Wright-Patterson AFB, OH
- CPSC-C-79-1034. (May 1981 – revised October 1982) *Development of Test Equipment and Methods for Measuring Potentially Lethal and Otherwise Damaging Current Levels*. Underwriters Laboratory under contract to the U.S. Consumer Product Safety Commission.
- Defrin, R., Shachal-Shiffer, M., Hadgadg, M. & Peretz, H. (2006) A quantitative somatosensory testing of warm and heat-pain thresholds: The effect of body region and measurement method. *Clinical Journal of Pain*, 22, 130-136.
- GIAG-3 Technical Panel Instructions, Aug. 1986.
- Geng, Q., Holmer, L., Hartog, D. E. A., et al. (2006). Temperature limit values for touching cold surfaces with the fingertip. *The Annals of Occupational Hygiene*. 50, 851-862.
- Greene, L. C., Alden, J. C. & Hardy, J. D. (1958). Adaptation to Pain. *Federation Proceedings*. 17, 60 (1).
- Halpern, D. & Hakel, M. D. (2003). *Applying the science of learning: to the university and beyond – Teaching for long term retention and transfer*. Retrieved from the University of Memphis Web site: <http://www.psyc.memphis.edu/learning/phaseone.shtml>.
- Hatton, A.P. & Halfdanarson, H. (1982). Role of Contact Resistance in Skin Burns. *J. Biomedical Engineering*, Vol. 4, pp. 97-102
- IEC 60601-1. (2005). Medical Electrical Equipment – Part 1: General Requirements for Basic Safety and Essential Performance, 3rd edition. International Electrotechnical Commission (IEC).
- IEC 60990. (1999). Methods of Measurement of Touch Current and Protective Conductor Current, 2nd edition. International Electrotechnical Commission (IEC).
- IEC/TS 61201. (2007). Technical Specification: Use of Conventional Touch Voltage Limits – Application Guide, Edition 2.0. International Electrotechnical Commission (IEC).
- Jiang, S.C., Ma, N., Li H.J., & Zhang, X.X. (2002). Effects of thermal properties and geometrical dimensions on skin burn injuries. *Burns*, 28(8), 713–717.
- JSC-12770. (1985). Shuttle Flight Operations Manual. Houston, TX. NASA JSC.
- JSC-18702. (1985). Flight Data File, Spacelab, In-Flight Maintenance (IFM) Checklist Mission Operations Directorate. Houston, TX. NASA Johnson Space Center.
- JSC 28533. (2000). International Space Station Catalogue of IVA Government Furnished Equipment Flight Crew Equipment. NASA Johnson Space Center.
- JSC 39116. (1998). EMU Phase VI Glove Thermal Vacuum Test and Analysis Final Report, Doc. #CTSD-SS-1621, NASA Johnson Space Center.
- Lloyd-Smith, D. L. & Mendelsohn, K. (1948). Tolerance limits to radiant heat. *British Medical Journal*, p. 975.
- MA2-99-142. (October 12, 1999). Memorandum: On-Orbit Bonding and Grounding. Johnson Space Center.

MA2-99-170. (February 11, 2000). Memorandum: Crew Mating/Demating of Powered Connectors. Johnson Space Center.

MIL-HDBK-759A. (1981). Human Factors Engineering Design Guidelines, U.S. Army Human Engineering Lab. Department of Defense.

MIL-STD-1472F. (1999). Human Engineering. Department of Defense.

Moritz, A.R. & Henriques, F.C. (1947). Studies in Thermal Injury II. The Relative Importance of Time and Air Surface Temperatures in the Causation of Cutaneous Burns. *Am J Pathol*, 23, 695–720.

MSFC-STD-512. (1974). Standard Man/System Design Criteria for Manned Orbiting Payloads, NASA-Marshall Space Flight Center.

MSFC-STD-512A. Stokes, J.W. (1976). Man/System Requirements for Weightless Environments Airesearch Mfg. Co., NASA-Marshall Space Flight Center.

NASA-STD-4003. (2003). Electrical Bonding for NASA Launch Vehicles, Spacecraft, Payloads, and Flight Equipment. NASA.

NASA/TP-2006-213725. Goodman, J. (2006). Crew Station Aspects of Manned Spacecraft, Volume 2, Houston, TX. NASA Johnson Space Center.

Operational Habitability (OpsHab). (2001). Debrief Summary for ISS Expedition. Houston, TX. NASA Johnson Space Center.

Operational Habitability (OpsHab). (2008). International Space Station and Mir Crew Comments Database prepared by Habitability and Human Factors. Houston, TX. NASA Johnson Space Center.

PD-ED-1214. Electrical Grounding Practices for Aerospace Hardware. Marshall Space Flight Center.

PT-TE-1417. Electrical Isolation Verification (DC). Marshall Space Flight Center.

Reilly, J.P. (1998). “Applied Bioelectricity: From Electrical Stimulation to Electropathology” New York, Springer-Verlag, ISBN: 0-387-98407-0.

Stoll, A. M., Chianta, M. A., & Piergallini, J. R. (1979). Thermal Conduction Effects in Human Skin. *Aviat Space Environ Med*, 50(8), 778–787.

TA-94-029. (April 29, 1994). Memorandum: Crewperson Electrical Shock from Incidental Contact. NASA Johnson Space Center.

TABLE of CONTENTS

10	CREW INTERFACES	900
10.1	Introduction	900
10.2	General.....	900
10.2.1	Usability	900
10.2.2	Simplicity	902
10.2.3	Consistency	903
10.2.3.1	Consistency vs. Distinction	904
10.2.4	Legibility	905
10.2.4.1	Legibility Methods	905
10.2.4.2	International Standards on Legibility	907
10.2.5	Research Needs	907
10.3	Display Devices	907
10.3.1	Display Metrics	908
10.3.1.1	Types of Display Metrics	908
10.3.2	Viewing Conditions.....	908
10.3.2.1	Viewing Distance	909
10.3.2.1.1	Gaze Angle.....	910
10.3.2.1.2	Viewing Angle	910
10.3.2.1.3	Ambient Light.....	910
10.3.2.1.4	Reflections.....	910
10.3.2.1.4.1	Measuring Reflections.....	912
10.3.2.1.4.2	Impact of Reflections on Displayed Images.....	913
10.3.2.1.4.3	Optical Treatments to Reduce Reflections and Glare	913
10.3.2.1.5	Adaptation	913
10.3.2.1.6	Effect of Sunglasses on Display Viewing	914
10.3.2.1.7	Viewing Conditions: Related Standards.....	914
10.3.2.2	Luminance and Contrast.....	916
10.3.2.2.1	Luminance.....	916
10.3.2.2.1.1	Maximum Display Luminance.....	916
10.3.2.2.1.2	Minimum Display Luminance.....	917
10.3.2.2.1.3	Gamma and Grayscale.....	917
10.3.2.2.2	Contrast	918
10.3.2.2.2.1	Contrast Ratio.....	919
10.3.2.2.2.2	Michelson Contrast	919
10.3.2.2.2.3	Image Contrast	920
10.3.2.2.2.4	Contrast Energy.....	920
10.3.2.2.2.5	Visible Contrast Energy	920
10.3.2.2.2.6	Ambient Contrast	921
10.3.2.2.2.7	Dynamic Contrast.....	921
10.3.2.2.2.8	Existing Standards for Contrast.....	921
10.3.2.2.3	Luminance and Contrast: Related Standards.....	921
10.3.2.3	Spatial Metrics	923
10.3.2.3.1	Pixel	924

10.3.2.3.2	Resolution.....	924
10.3.2.3.3	Pixel Pitch.....	925
10.3.2.3.4	Visual Resolution.....	925
10.3.2.3.5	Modulation Transfer Function.....	926
10.3.2.3.6	Uniformity.....	927
10.3.2.3.7	Mura.....	927
10.3.2.3.8	Pixel Fill Factor.....	927
10.3.2.3.9	Spatial Metrics: Related Standards.....	928
10.3.2.4	Temporal Metrics.....	929
10.3.2.4.1	Flicker.....	929
10.3.2.4.2	Step Response and Response Time.....	930
10.3.2.4.3	Motion Blur.....	930
10.3.2.4.4	Long-Term Behavior.....	932
10.3.2.4.5	Temporal Metrics: Related Standards.....	933
10.3.2.5	Color.....	933
10.3.2.5.1	Color Primaries.....	933
10.3.2.5.2	Color Gamut.....	934
10.3.2.5.3	White Point.....	935
10.3.2.5.4	Ambient Color Gamut.....	936
10.3.2.5.5	Color Tracking.....	936
10.3.2.5.6	Related Standards.....	937
10.3.2.6	Viewing Angle Performance.....	938
10.3.2.6.1	Viewing Angle: Related Standards.....	940
10.3.2.7	Text.....	940
10.3.2.7.1	Background Research.....	941
10.3.2.7.2	Character Size (Degrees).....	944
10.3.2.7.3	Character Size (Pixels).....	945
10.3.2.7.4	Character Size (Points).....	946
10.3.2.7.5	Stroke Width.....	946
10.3.2.7.6	Character Spacing.....	946
10.3.2.7.7	Line Spacing.....	947
10.3.2.7.8	Word Spacing.....	947
10.3.2.7.9	Character Contrast.....	947
10.3.2.7.10	Related Standards.....	947
10.3.2.8	Research Needs.....	948
10.3.2.8.1	Uniformity.....	948
10.3.2.8.2	Mura.....	948
10.3.2.8.3	Motion Blur.....	948
10.3.2.8.4	3D Color-Gamut Metrics.....	948
10.3.2.8.5	Text.....	949
10.3.2.8.6	Legibility and Symbol Discriminability.....	949
10.3.2.8.7	Clutter.....	949
10.3.2.8.8	Global Display Quality Metrics.....	949
10.3.2.8.9	Human Factors Metrics.....	950
10.3.2.8.10	Model-based Metrics.....	950
10.3.3	Display Technologies.....	950
10.3.3.1	Overview of Display Technologies.....	950
10.3.3.2	Direct-View Displays of the Emissive Type.....	952

10.3.3.2.1	Cathode Ray Tubes	952
10.3.3.2.2	Plasma Display Panels.....	953
10.3.3.2.3	Light-Emitting Diodes and Organic Light-Emitting Diodes.....	954
10.3.3.2.4	Other Direct-View Emissive Display Technologies.....	957
10.3.3.2.5	Emerging and Future Direct-View Emissive Display Technologies.....	957
10.3.3.2.6	Direct-View Displays of the Non-Emissive Type.....	958
10.3.3.2.7	Liquid Crystal Displays.....	958
10.3.3.2.8	Other Direct-View Non-Emissive Display Technologies	960
10.3.3.2.9	Emerging and Future Direct-View Non-Emissive Display Technologies.....	961
10.3.3.3	Projection Displays	961
10.3.3.3.1	Projection Displays Using CRT Imagers	962
10.3.3.3.2	Projection Displays Using Liquid Crystal Imagers.....	963
10.3.3.3.3	Projection Display Using MEMS Imagers	965
10.3.3.3.4	Emerging and Future Projection Display Technologies	966
10.3.3.4	Related Display Standards.....	966
10.3.4	Research Needs	968
10.4	Controls.....	968
10.4.1	Control design and operation	968
10.4.2	Control Devices.....	969
10.4.2.1	Push Button	969
10.4.2.1.1	Shape	969
10.4.2.1.2	Positive Indication.....	969
10.4.2.1.3	Channel or Cover Guard.....	969
10.4.2.1.4	Dimensions, Resistance, Displacement, and Separation	969
10.4.2.1.5	Interlocks or Barriers.....	969
10.4.2.2	Foot-Operated Switches	970
10.4.2.2.1	Use.....	970
10.4.2.2.2	Operation.....	971
10.4.2.2.3	Dimensions, Resistance, and Displacement	971
10.4.2.2.4	Feedback	971
10.4.2.3	Keyboard.....	971
10.4.2.3.1	Use.....	971
10.4.2.3.2	Layout of Keys	972
10.4.2.3.3	Numeric Keys.....	972
10.4.2.3.4	Key Displacement	972
10.4.2.3.5	Keystroke Feedback	973
10.4.2.3.6	Keyboard Height and Slope	974
10.4.2.3.7	Key Repeat Rate.....	975
10.4.2.3.8	Home Row Locator.....	975
10.4.2.4	Toggle Switch.....	975
10.4.2.4.1	Use.....	975
10.4.2.4.2	Accidental Actuation.....	975
10.4.2.4.3	Dimensions, Resistance, Displacement, and Separation	976
10.4.2.4.4	Positive Indication.....	976
10.4.2.4.5	Orientation.....	976
10.4.2.5	Legend Switches	976
10.4.2.5.1	Dimensions, Resistance, Displacement, and Separation	977

10.4.2.5.2	Barrier Height.....	977
10.4.2.5.3	Other Requirements.....	977
10.4.2.6	Rocker Switches.....	979
10.4.2.6.1	Use.....	979
10.4.2.6.2	Accidental Actuation.....	979
10.4.2.6.3	Positive Indication.....	979
10.4.2.6.4	Dimensions, Resistance, Displacement, and Separation.....	979
10.4.2.6.5	Orientation.....	979
10.4.2.6.6	Color and Illumination.....	980
10.4.2.7	Slide Switch Controls.....	982
10.4.2.7.1	Use.....	982
10.4.2.7.2	Accidental Actuation.....	982
10.4.2.7.3	Dimensions, Resistance, and Separation.....	982
10.4.2.7.4	Orientation.....	982
10.4.2.7.5	Positive Indication.....	982
10.4.2.8	Discrete Push-Pull Controls.....	983
10.4.2.8.1	Use.....	983
10.4.2.8.2	Handle Dimensions, Displacement, and Clearances.....	983
10.4.2.8.3	Rotation.....	984
10.4.2.8.4	Detents.....	984
10.4.2.8.5	Snagging and Inadvertent Contact.....	984
10.4.2.8.6	Direction of Control Motion.....	984
10.4.2.8.7	Resistance.....	984
10.4.2.9	Printed Circuit Switch Controls.....	986
10.4.2.9.1	Use.....	986
10.4.2.9.2	Dimensions, Resistance, Displacement, and Separation.....	986
10.4.2.9.3	Shape.....	986
10.4.2.10	Levers.....	986
10.4.2.10.1	Use.....	986
10.4.2.10.2	Coding.....	986
10.4.2.10.3	Limb Support.....	987
10.4.2.10.4	Dimensions.....	987
10.4.2.10.5	Resistance.....	987
10.4.2.10.6	Displacement and Separation.....	987
10.4.2.11	Displacement (Isotonic) Joysticks.....	988
10.4.2.12	Hand-Operated Displacement Joysticks.....	988
10.4.2.12.1	Use.....	988
10.4.2.12.2	Dynamic Characteristics.....	989
10.4.2.12.3	Dimensions and Clearance.....	989
10.4.2.13	Finger-Operated Displacement Joysticks.....	989
10.4.2.13.1	Use.....	989
10.4.2.13.2	Dynamic Characteristics.....	989
10.4.2.13.3	Dimensions, Resistance, and Clearance.....	989
10.4.2.14	Thumbtip- / Fingertip-Operated Displacement Joysticks.....	990
10.4.2.14.1	Use.....	990
10.4.2.14.2	Dynamic Characteristics.....	990
10.4.2.14.3	Dimensions, Resistance, and Clearance.....	990
10.4.2.15	Isometric Joystick (Two-Axis Controller).....	991

10.4.2.16	Hand-Operated Isometric Joysticks.....	992
10.4.2.16.1	Use.....	992
10.4.2.16.2	Dynamic Characteristics.....	992
10.4.2.16.3	Dimensions, Resistance, and Clearance.....	992
10.4.2.17	Finger-Operated.....	992
10.4.2.18	Thumbtip- / Fingertip-Operated Isometric Joysticks.....	992
10.4.2.18.1	Use.....	992
10.4.2.18.2	Dimensions, Resistance, and Clearance.....	993
10.4.2.18.3	Ball Control.....	993
10.4.2.18.4	Dimensions and Resistance.....	993
10.4.2.19	Stylus.....	993
10.4.2.19.1	Force.....	994
10.4.2.19.2	Design.....	994
10.4.2.20	Mouse.....	994
10.4.2.20.1	Dimensions.....	995
10.4.2.20.2	Mouse Position Sensor.....	995
10.4.2.21	Touch Screen.....	995
10.4.2.21.1	Dimensions.....	995
10.4.2.22	Pedals.....	996
10.4.2.22.1	Location.....	996
10.4.2.22.2	Pedal Return.....	996
10.4.2.22.3	Pedal Travel.....	997
10.4.2.22.4	Nonslip Pedal Surface.....	997
10.4.2.22.5	Dimensions, Resistance, Displacement, and Separation.....	997
10.4.2.23	Rotary Selector Switches.....	998
10.4.2.23.1	Use.....	998
10.4.2.23.2	Moving Pointer.....	998
10.4.2.23.3	Shape.....	999
10.4.2.23.4	Positions.....	999
10.4.2.23.5	Contrast.....	999
10.4.2.23.6	Parallax.....	999
10.4.2.23.7	Attachment.....	999
10.4.2.24	Control Dimensions, Resistance, Displacement, and Separation.....	999
10.4.2.25	Discrete Thumbwheel Controls.....	1000
10.4.2.25.1	Use.....	1000
10.4.2.25.2	Shape.....	1001
10.4.2.25.3	Coding.....	1001
10.4.2.25.4	Direction of Movement.....	1001
10.4.2.25.5	Numerals.....	1001
10.4.2.25.6	Visibility.....	1001
10.4.2.25.7	Dimensions.....	1001
10.4.2.25.8	Resistance.....	1001
10.4.2.25.9	Separation.....	1002
10.4.2.26	Continuous-Adjustment Thumbwheel Controls.....	1002
10.4.2.26.1	Use.....	1002
10.4.2.26.2	Orientation and Movement.....	1002
10.4.2.26.3	Turning Aids.....	1002
10.4.2.26.4	Dimensions, Separation, and Resistance.....	1003

10.4.2.26.5	Labeling and Visibility	1003
10.4.2.26.6	OFF Position	1003
10.4.2.27	Knobs	1003
10.4.2.27.1	Use.....	1003
10.4.2.27.2	Dimensions, Torque, and Separation	1004
10.4.2.28	Cranks	1005
10.4.2.28.1	Use.....	1005
10.4.2.28.2	Grip Handle.....	1005
10.4.2.28.3	Dimensions, Resistance, and Separation.....	1005
10.4.2.28.4	Location.....	1005
10.4.2.28.5	Folding Handle.....	1005
10.4.2.29	Hand Wheels (Two-Hand Operated).....	1006
10.4.2.29.1	Use.....	1006
10.4.2.29.2	Turning Aids	1007
10.4.2.29.3	Spinner Handles.....	1007
10.4.2.29.4	Direction of Movement.....	1007
10.4.2.29.5	Dimensions, Resistance, Displacement, and Separation.....	1007
10.4.2.29.6	Steering Wheel Shape	1007
10.4.2.29.7	Power Steering Failure	1007
10.4.2.29.8	Steering Ratio.....	1007
10.4.2.30	Other Controls.....	1010
10.4.2.30.1	Freespace controller.....	1010
10.4.2.30.2	3D controller	1010
10.4.2.30.3	Voice activation.....	1010
10.4.2.30.4	Track point	1010
10.4.3	Compatibility of movement	1011
10.4.4	Control feedback	1013
10.4.5	Use of Stops	1014
10.4.6	Protection against inadvertent activation	1014
10.4.7	Use of Coding	1015
10.4.7.1	Size Coding	1016
10.4.7.2	Shape Coding.....	1017
10.4.7.3	Color Coding for Hardware Controls.....	1017
10.4.7.4	Coding for emergency controls.....	1018
10.4.8	Restraints for control operation.....	1018
10.4.9	High-g operations.....	1018
10.4.9.1	Over 3g.....	1018
10.4.9.2	Over 2g.....	1018
10.4.9.3	Supports for control Inputs during high-g.....	1019
10.4.10	Cursor Control Device Use under Vibration.....	1019
10.4.11	Gloved operations with Cursor Control Devices	1019
10.4.12	Type of Cursor Movement.....	1019
10.4.13	Research Needs	1019
10.5	Display Device and Control Layout.....	1019
10.5.1	Two crew operations.....	1019
10.5.2	Viewing critical displays and controls	1020
10.5.3	Viewing frequently used displays and controls.....	1020

10.5.4	Display-Control Relationships	1020
10.5.4.1	Orientation.....	1020
10.5.4.2	Location and Arrangement.....	1021
10.5.4.3	Display and control grouping.....	1022
10.5.4.4	Display and control spacing.....	1022
10.5.5	Successive operation of displays and controls	1023
10.5.6	Obscured controls.....	1023
10.5.7	Self-illuminated controls and displays	1024
10.5.8	Reach requirements	1024
10.5.9	Research Needs	1024
10.6	Visual Displays.....	1025
10.6.1	Task-relevant Information	1025
10.6.2	Minimal Information	1026
10.6.3	Language and Abbreviations	1026
10.6.4	Effective and Consistent Verbiage.....	1026
10.6.5	Display density and hierarchy	1027
10.6.6	Identification	1027
10.6.7	Grouping	1028
10.6.8	Distinctiveness.....	1028
10.6.8.1	Operational Distinction	1028
10.6.8.2	Discrimination	1028
10.6.8.3	Syntax Distinction.....	1029
10.6.8.4	Spatial Distinction and Grouping.....	1029
10.6.9	Spacing.....	1029
10.6.10	Alignment.....	1029
10.6.11	Scrolling	1029
10.6.12	Navigation	1030
10.6.13	Selection	1030
10.6.14	Menus.....	1030
10.6.15	Toolbars and Status Bars.....	1031
10.6.16	Dialog Boxes.....	1031
10.6.17	Modes.....	1031
10.6.18	Use of Graphics.....	1032
10.6.19	Use of color	1032
10.6.20	Use of Cues	1033
10.6.20.1	Visual cues	1033
10.6.20.2	Auditory cues	1034
10.6.20.3	Tactile cues.....	1034
10.7	Audio Displays.....	1034
10.7.1	When to Use.....	1035
10.7.2	General Design.....	1036
10.7.3	Signal Design	1037
10.7.3.1	Nonspeech Signal Design.....	1037
10.7.3.2	Speech Signal Design.....	1037
10.7.4	Design for Audio Input and Output Equipment.....	1038
10.7.4.1	Frequency Response.....	1038
10.7.4.2	Microphones and Other Input Devices.....	1038

10.7.4.3	Loudspeakers and Other Output Devices.....	1039
10.7.4.4	Use of De-Emphasis.....	1039
10.7.4.5	Feedback Noise.....	1039
10.7.4.6	Isolation of Feedback from Earphone or Speaker to Microphone	1039
10.7.4.7	Reverberation Time.....	1039
10.7.5	Audio Interface Design.....	1040
10.7.5.1	Operator Comfort.....	1040
10.7.5.2	Annunciator Controls.....	1040
10.7.6	Voice Communication Controls.....	1040
10.7.7	Research Needs.....	1041
10.8	Crew-System Interaction	1041
10.8.1	Feedback.....	1041
10.8.2	Types of Feedback.....	1041
10.8.3	Timing of Feedback.....	1042
10.8.4	State information.....	1044
10.8.4.1	Types of Status Indicators.....	1044
10.8.4.2	Methods of Indicating Status.....	1044
10.8.4.3	Precision of Status.....	1044
10.8.5	Research Needs.....	1044
10.9	Crew Notifications and Caution and Warning	1045
10.9.1	Auditory Alarm Functions.....	1045
10.9.1.1	Levels of Alarm.....	1045
10.9.2	Design of Auditory Alarms.....	1047
10.9.2.1	Auditory Alarm Sound Pressure Level.....	1047
10.9.2.2	Auditory Alarm Frequency Content.....	1049
10.9.2.3	Auditory Alarm Discriminability: Typology and Temporal Pattern.....	1049
10.9.2.4	Minimizing Auditory Alarm Startle Effect.....	1051
10.9.2.5	Consideration of Auditory Alarm Levels at the Ear.....	1052
10.9.2.5.1	Design of Visual Alarms.....	1052
10.9.3	Visual Versus Auditory Alarms.....	1053
10.9.4	Research Needs.....	1054
10.10	Electronic Procedures	1054
10.11	Hardware Labels	1058
10.11.1	General.....	1058
10.11.2	Standardization.....	1059
10.11.2.1	Nomenclature and Syntax.....	1059
10.11.2.2	Abbreviations, including Acronyms.....	1059
10.11.3	Identification.....	1059
10.11.3.1	Item Identification.....	1060
10.11.3.2	Interface Identification.....	1060
10.11.3.3	Operation Identification.....	1060
10.11.4	Avoiding Hazards.....	1060
10.11.5	Visual Properties of a Label.....	1061
10.11.5.1	Readability and Legibility.....	1061
10.11.5.2	Orientation of Labels.....	1061
10.11.5.3	Location of Labels.....	1062

10.11.5.4	Alignment of Labels.....	1062
10.11.5.5	Color.....	1063
10.11.6	Research Needs	1064
10.12	Information Management.....	1065
10.12.1	General Considerations	1065
10.12.2	Types of Information.....	1065
10.12.3	Crew Operability	1066
10.12.4	Data validity.....	1066
10.12.5	Data Availability	1067
10.12.5.1	Data Rate.....	1067
10.12.5.2	Data Fidelity	1067
10.12.6	Data Distribution	1068
10.12.6.1	Locations of Data	1068
10.12.6.2	Information Capture and Transfer.....	1068
10.12.7	Data Backup	1068
10.12.7.1	Form of Backup Data	1068
10.12.7.2	Automated Backup.....	1068
10.12.7.3	Manual Backup	1069
10.12.7.4	Manual Data Restore.....	1069
10.12.8	Information Management System Requirements	1069
10.12.9	Electronic Communications	1070
10.12.10	Research Needs	1070
10.13	Automated Systems	1071
10.13.1	Automation.....	1071
10.13.1.1	General	1071
10.13.1.2	Human / Machine Task Division	1072
10.13.1.3	Levels of Automation.....	1073
10.13.1.4	Biasing Effects on Control	1075
10.13.1.5	The Need for Effective Crew Interfaces.....	1076
10.13.2	General Crew Interface Design Rules for Automation	1077
10.13.2.1	Implications for Automation Tasks and Crew Interfaces for Robots.....	1080
10.13.3	Limitations of Automation	1080
10.13.4	Research Needs	1081
10.14	Mobile Systems.....	1081
10.14.1	Definition of Terms	1081
10.14.2	Scope of Capabilities for Mobile System Interfaces	1083
10.14.3	Similarities with Other User Interfaces	1084
10.14.4	Significant Aspects of User Interfaces with Mobile Systems	1086
10.14.4.1	Presence.....	1087
10.14.4.2	Frame of Reference	1087
10.14.4.3	Latency	1088
10.14.4.4	Sensory Conflict.....	1088
10.14.4.5	Reduced Sensorimotor Coordination	1089
10.14.4.6	Reduced productivity	1089
10.14.4.7	Visual / Manual Aspect of Tasks	1090
10.14.5	User Interfaces for Semi-autonomous Systems.....	1091

10.14.6	Operational Constraints and Considerations	1091
10.14.7	Research Needs	1092
10.15	REFERENCES	1093

TABLE of FIGURES

Figure 10.3-1. Gaze angle, viewing angle, and viewing distance	909
Figure 10.3-2. The three basic types of reflection.....	911
Figure 10.3-3. The three basic types of reflection and their separate and combined effects on a display surface	912
Figure 10.3-4. Two sample measurement geometries for specular and diffuse reflectance.....	912
Figure 10.3-5 Illustration of quantities related to luminance contrast.....	919
Figure 10.3-6 Measurement of step response and motion blur of an LCD.....	931
Figure 10.3-7 Edge profile between gray levels of 150 and 139 on a particular plasma display, exhibiting overshoot and ringing	932
Figure 10.3-8 ITU-Rec. 709 / sRGB display color primaries plotted on a CIE 1976 UCS diagram.	934
Figure 10.3-9 Three-dimensional color gamut for the ITU-Rec. 709 / sRGB color primaries plotted in the CIE L*a*b* color space	935
Figure 10.3-10 Peak photopic contrast ratio iso-contours for an active-matrix LCD plotted in spherical coordinates.	939
Figure 10.3-11 Example of font dimensions.	941
Figure 10.3-12 Effect of character width and spacing on reading rate. (Legge, et al., 1985).....	942
Figure 10.3-13 Reading rate as a function of letter size or spacing. (S. T. Chung, et al., 1998).....	942
Figure 10.3-14 Reading rate as a function of horizontal spacing. (S. T. L. Chung, 2002).....	943
Figure 10.3-15 Reading rate as a function of vertical spacing. Data from (S. T. Chung, 2004)	944
Figure 10.3-16 Character height standards in minutes of arc.....	945
Figure 10.3-17 Range of currently available display technologies.	951
Figure 10.4-1 Requirements for push buttons (finger- or hand-operated).	970
Figure 10.4-2 Requirements for foot-operated switches.	971
Figure 10.4-3 Standardized numeric keyboard layouts.....	972
Figure 10.4-4 Requirements for keyboard keys.	973
Figure 10.4-5 Tactile feedback recommendations.	974
Figure 10.4-6 Requirements for keyboard slope and height.	974
Figure 10.4-7 Requirements for toggle switches.....	976
Figure 10.4-8 Requirements for legend switches.....	978
Figure 10.4-9 Requirements for rocker switches.	981
Figure 10.4-10 Requirements for slide switches.....	983
Figure 10.4-11 Requirements for push-pull controls. Source: MIL-STD-1472F.....	985
Figure 10.4-12 Requirements for levers.....	987
Figure 10.4-13 Requirements for displacement (isotonic) joysticks.....	991
Figure 10.4-15 Requirements for ball controls.	993
Figure 10.4-16 Requirements for styluses. Source: MIL-STD-1472F and HFES (2007)	994
Figure 10.4-17 Recommended dimensions for mouse interfaces	995
Figure 10.4-18 Recommended dimensions for touch screen areas.....	996
Figure 10.4-19 Requirements for pedals.....	998

Figure 10.4-20 Requirements for rotary selector switches.....	1000
Figure 10.4-21 Requirements for discrete thumbwheel controls.	1002
Figure 10.4-22 Requirements for continuous-adjustment thumbwheels.....	1003
Figure 10.4-23 Requirements for knobs.....	1004
Figure 10.4-24 Requirements for cranks.	1006
Figure 10.4-25a Requirements for handwheels (page 1 of 2).....	1008
Figure 10.4-25b Requirements for handwheels (page 2 of 2). Source: MIL-STD-1472F.....	1009
Figure 10.4-26 Expected system function and control movement relationships. Source: Campbell, 1998.	1012
Figure 10.4-27 Suggested control selections to match user expectations. (Campbell, et al., 1998).....	1013
Figure 10.4-28 Advantages and disadvantages of various types of control coding.....	1016
Figure 10.5-1 Recommended minimum spacing between controls (for bare-handed operations).	1023
Figure 10.9-1 Annotated illustrative example from ISO 7731:2003. Abscissa indicates octave band center frequencies in Hz. Ordinate indicates octave band sound levels in decibels. Alarm signal level (LS, oct : solid line) has a spectral component in the 1 kHz octave band that is 15 dB higher than the noise level (LN, oct : dashed line).	1048
Figure 10.9-2 Pulses forming an alarm “burst” (ISO, 1994)	1051
Figure 10.10-1. An example of an integrated electronic procedure (upper display) that can control an onboard display (lower display). In this example, the appropriate command popup (magenta menu on lower display) is auto-cued by the electronic procedure (upper display).	1057
Figure 10.13-1. Deep Rover submersible	1077
Figure 10.13-2. Deep Rover Control Seat with sliding armrests for vehicle control and two-axis force-sensing control sticks for manipulator control.....	1077
Figure 10.14-1 Robonaut. Source: robonaut.jsc.nasa.gov	1082
Figure 10.14-2 Berkeley Lower Extremity Exoskeleton. Source: Dr. Kazerooni, University of California at Berkeley (Kazerooni, 1990)	1082
Figure 10.14-3 Categories of teleoperation.	1083
Figure 10.14-4 User-interface information channels.....	1085
Figure 10.14-5 Human factors guidelines for developing an industrial robot control pendant.....	1086
Figure 10.14-6 Transaction frequency vs. response time. From Doherty & Thadhani, 1982.	1090

TABLE of TABLES

Table 10.3-1 Viewing Condition Standards	914
Table 10.3-2 Luminance and Contrast Standards	921
Table 10.3-3 Selected Standard Matrix Display Dimensions in Pixels.....	925
Table 10.3-4 Visual Resolution for a Number of Representative Displays at a Number of Viewing Distances.....	926
Table 10.3-5 Spatial Metric Standards	928
Table 10.3-6 Temporal Metric Standards	933
Table 10.3-7 Color Standards.....	937
Table 10.3-8 Viewing Angle Standards	940
Table 10.3-9 Character Size Requirements in Pixels.....	946
Table 10.3-10 Text Standards	947
Table 10.3-11 CRT Technology Attribute Ratings and Comments.....	953
Table 10.3-12 PDP Technology Attribute Ratings and Comments	954
Table 10.3-13 OLED / PLED Technology Attribute Ratings and Comments	956
Table 10.3-14 LCD Technology Attribute Ratings and Comments.....	959
Table 10.3-15 CRT-Based Projection Display Attribute Ratings and Comments	963
Table 10.3-16 LC Imager-Based Projection Display Attribute Ratings and Comments.....	964
Table 10.3-17 MEMS Imager-Based Projection Display Attribute Ratings and Comments.....	965
Table 10.7-1 Selection of Audio Signals	1036
Table 10.8-1 Maximum Acceptable System Response Times.....	1043
Table 10.9-1 Alarm Classifications.....	1046
Table 10.9-2 Shuttle Specifications for Class 1–3 Alerts	1047
Table 10.9-3 Guidelines for Using Auditory vs. Visual Alarms.....	1054
Table 10.13-1 Levels of Automation	1074
Table 10.13-2 Rules for Designing Crew Interfaces for Automatic Systems	1077
Table 10.13-3 Interface Design Rules for Automatic Systems from the System’s Perspective.....	1078

10 CREW INTERFACES

10.1 INTRODUCTION

The user interface of a system – referred to as a *crew interface* in this context – is any part of that system through which information is exchanged between the crewmember and the system. Well-designed crew interfaces are critical for crew safety and productivity, and these interfaces minimize training requirements. This chapter includes discussion of categories of crew interfaces including visual, audio, and tactile displays, controls, and labels. Visual displays deliver information by using visible media to present text, graphics, colors, images, video, and symbols. Audio displays deliver information using sound, and include communication and audio alarms. Tactile displays include vibration, force feedback and mechanical stops, switch detents, and button clicks. Controls allow the user to provide input to a system in the form of information or a change in physical state. Labels form a distinct class of user interfaces, usually providing a static identification of a device or device component, or brief static message.

A well-designed crew interface has the following properties:

- Usability, including effectiveness, efficiency, and user satisfaction
- Simplicity of visual design and operation
- Consistency of elements, style, and interaction
- Legibility of text and graphics

10.2 GENERAL

10.2.1 Usability

Usability refers to how easy a system, product, or technique is to use. Making a display usable involves presenting information in such a manner that it can be interpreted rapidly and correctly. Consider the following important components of user interfaces for usability:

- User – Any system developer should keep in mind the range of both size and skills of the user population and plan accordingly.

For example, a high level of familiarity with many abbreviations and English words can be assumed in the U.S. space flight population, but cannot be assumed in dealing with crews from other cultures. For missions involving crews from other cultures, only high-frequency English words should be used on user interface.

- Users' Expectations or Preferences – The users' expectations as to how the system will perform, and familiarity with similar systems, should be considered in system development. For example, users may expect an icon to function like similar icons they have encountered in the past. Designers need to keep the user's previous experience in mind when designing the display interface.

- User Control and Automation – The user should be in control of the system in accordance with the user’s allocated function and responsibilities, so that the user is playing an active and not a passive role in the outcomes of the system operations.

For example, issuing feedback and alerting users when they are to make a change to the system are features of the software that keep the user in control.

- Environmental Conditions – The environmental conditions in which the system will be operated should be considered in the design of the system.

For example, in space flight we must consider that a high level of background noise exists and incorporate this fact into our design of auditory feedback.

Usability is a key element of the human-centered design approach. Human-centered design is a design philosophy and a process that takes into account human capabilities and limitations at each stage of the design process. Applying a human-centered design process to system development contributes to crew health and safety by increasing system usability. Insufficient integration of human concerns with the vehicle design may result in inadequate interfaces and deficiencies in commonality, consistency, and usability that translate into less-than-optimal operations, higher training costs, and an increased risk to mission objectives. A usable system will provide increased efficiency, effectiveness, and satisfaction. Furthermore, good usability reduces errors, training time, and overall lifecycle costs, and it is indispensable to ensure crew safety and mission success.

- Usability testing should be performed on all hardware, software, procedures, and training materials with which a crewmember will interact. Depending on the size of the system, testing can be scoped using task analysis to determine the critical tasks/systems to be tested.

The International Organization for Standardization published a number of standards that contain usability models for the operational evaluation of usability. The ISO 9241-11 standard (1998) defines usability as “the extent to which a product can be used by specified users to achieve specified goals,” and recommends evaluating usability in terms of measures of efficiency, effectiveness, and satisfaction. Measures of efficiency relate the level of effectiveness achieved to the expenditure of resources.

The most frequently used metrics of efficiency: step or task completion time; deviation from the optimal path, which is the number of times users do not use the most efficient path to reach their goals.

Measures of effectiveness relate the goals or sub-goals of the user to the accuracy and completeness with which these goals can be achieved. The most frequently used metrics of effectiveness are error rates and task/step success. Error rates can be calculated in multiple ways: total number of errors on every step (possibly divided by the number of steps), total number of errors on every task, or mean number of errors. The use of error across all task steps *counts* versus *rates* (where the number of steps is in the denominator, resulting in a ratio of errors to steps or a percentage) is at the discretion of the analyst, and should be guided by the specifics of

the test. An example of task/step completion rates would be: 9 out of 10 tasks have been completed successfully.

Satisfaction measures the extent to which users are free from discomfort as well as their attitudes toward the use of the system. The most frequently used metrics of satisfaction include: ratings of satisfaction with the interface, survey addressing satisfaction with specific aspects of the interface, and specific attitudes toward the interface, as measured on a standardized attitude questionnaire.

Users' satisfaction can be measured by attitude rating scales such as the Software Usability Measurement Inventory (SUMI) or the System Usability Scale (SUS) (Bangor, Kortum, & Miller, 2008; Kirakowski & Corbett, 1993). The System Usability Scale is a 10-item attitude scale that has been standardized. All items are rated on 5-point Likert scales (1 = strongly disagree; 5 = strongly agree). The final composite score can range from 1 to 100. Usable systems usually get a satisfaction score of 85.

10.2.2 Simplicity

User interfaces should be simple to use. A user interface is considered simple if it is easy to learn and easy to use. Crewmembers are trained on system use prior to a mission, but they often don't have an opportunity to use that system until much later, when details of operation may have been forgotten. In addition, systems must be usable under conditions of high stress (i.e., an emergency), with minimal cognitive effort. Simplicity must be designed into the system to ensure efficiency in training and effectiveness in operation.

Simplicity is important in preventing errors in execution. A display must not contain superfluous information. Every irrelevant visual item on a display takes attention away from the relevant items, thereby increasing chances for error. The design of displays should be based on a task analysis to identify the necessary and sufficient information to be presented.

Simplicity in control design means providing only necessary controls, making control inputs intuitive, and minimizing unnecessary motion or hand positions that would make gloved operations difficult. Note that more complex control inputs should be required for safety-critical inputs.

- A task analysis should be performed to determine the content of displays and the types and numbers of controls needed to perform a task.

Simplicity does not necessarily mean fewer features. It means providing what is needed to perform the task, at the right time, in a usable format.

10.2.3 Consistency

Consistency of an interface means that the knowledge users have learned using one part of the system or a subsystem can be applied to the rest of the interface, thus increasing their performance across the system.

Crew interfaces that perform similar functions should be designed to have similar visual designs and methods of interaction.

Advantages of consistent interfaces:

- Consistent interfaces are easier to learn. When rules and semantic meaning learned in one system can be applied to another system, that reduces learning time and effort.
- Consistent interfaces are easier to train. As a direct consequence of easier and faster learning, it is easier to train users on interfaces that are consistent with standards and other similar systems. Task knowledge and skills easily transfer from one system/situation to others.
- Consistency helps in quick identification and easy understanding of a system, thus improving performance.
- Consistency helps to keep error rates down. Task switching studies show that when people switch from performing one task to another, response times and error rates increase (Monsell, 2003). Switching between non-standardized systems may result in similar performance decrements. Standardization can also reduce overall training requirements and costs as well as diminish the incidence of negative transfer of training.
- Consistent interfaces reduce task completion times and increase satisfaction (Schneider and Shiffrin, 1977).
- Systems with consistent interfaces can be easier to develop. If templates and standard icon and code libraries are established and provided to developers, much less individual development needs to occur since modules can be quickly shared and only slightly modified as appropriate. This can result in a significant savings in development time and a user interface that is easier to learn and use.
- Consistency is applicable to interface elements, functionality, and methods of operation. In general, things that are conceptually similar should look and feel similar. Controls that are consistent have similar shape, texture, direction of operation, type, function, color, size, and location. Displays that are consistent have similar typeface, color, terminology, content, format, and symbology. Interactions that are consistent follow the same operational flow, and use consistent styles of input and output.
- A system should have *internal consistency*; i.e., consistency within the system, as well as *external consistency*, which is consistency with other systems and standards. Both types of consistency are important.
- If systems that perform similar functions do not operate in a consistent way, the system may not respond in a way that is predictable to the user (negative transfer of learning). Automatic control is then lost, as the user must now analyze all responses and check that

the input is received in the way intended. When the system changes so that it no longer responds in a way that the user can predict, the user loses trust in the capabilities of the system, which slows down productivity on this and other tasks.

Determining whether two interfaces are consistent is often subjective. Research has been conducted to try and make consistency a more verifiable concept (Sandor and Holden, 2009). A scale was developed that considers the consistency of user interface elements as well as the attributes and functions associated with those elements, including visual attributes (color, location, size, font), semantic attributes (terminology, meaning), and operational attributes (function, navigation, sequence). This scale can be used to make consistency judgments structured and quantitative.

10.2.3.1 Consistency vs. Distinction

As described above, things that perform similar functions should have a consistent look and feel. By contrast, components, actions, feedback, and system status indications with different purposes or functions should be distinct to avoid confusion and to help identification. Altering two or more dimensions (e.g., both color and shape) is beneficial in maximizing the differentiation of similar items.

- Crew interfaces that perform different functions should be designed to have distinct visual designs and methods of interaction.

Visual properties are most often the best way to distinguish among items. Items can differ in any of the visual dimensions: they can be different colors, different shapes, or in different spatial locations. Therefore, if users need to discriminate between two items, the items need to differ by at least one of these visual dimensions. For example, if two items have similar names but initiate different actions, visual information should be used to differentiate these items to prevent unintended actions.

Shape differentiation is a less noticeable distinction than color or location, especially in a high-vibration environment that degrades visual precision. The shape of an object can vary from simple (square or circle) to complex (icon of trash can, icon of binoculars).

- Given the low saliency of shape distinction, it should be used in conjunction with another differentiating visual property.

Correlating the shape of a control with its function can assist in distinguishing the control from another. For example, the landing gear switch in an aircraft is usually shaped to resemble a wheel or portion of the undercarriage, and a similar approach is often used for the flap switch.

Auditory properties can also distinguish between items. Auditory distinction is often used to differentiate the criticality of an auditory warning. Auditory information can vary in loudness, pitch, frequency, rate, and other dimensions. Distinguishing items on two or more of these dimensions produces a greater difference between the items than distinguishing them on only one dimension.

Deciding whether to distinguish items on the basis of one or more dimensions depends on the desired level of distinguishability of items. If two items have a low probability of being confused, then differing in one dimension may be sufficient.

- If items have a high probability of being confused, then they should differ in two or more dimensions.

Two items may also be distinguished by varying both the visual and auditory dimensions. For example, one command may be initiated by turning a square knob that produces a high-frequency beep, while another command may be initiated by turning a key-like shape that produces a series of mid-frequency beeps. Varying two dimensions will result in greater distinction than when varying only one dimension. This is because the user is provided with two different sources of feedback for the action. However, two sources of feedback may not be feasible in certain circumstances (e.g., high-noise environments, smoky environments); thus, the environment must be considered when attempting to differentiate items.

An example highlighting the importance of distinction comes from the International Space Station (ISS) Audio Terminal Unit interface. The “VOL” and “VOX” buttons are identically shaped buttons located beside each other on the Audio Terminal Unit. Periodically, this has resulted in crewmembers inadvertently pressing “VOX” and having a “hot” microphone to the ground. The buttons in this case are labeled very similarly, are in the same general location, and have the same shape. The only way to distinguish between the two buttons is to evaluate the last letter in the sequence. This amount of differentiation is not sufficient to preclude unintended activation of the wrong button. Additional differentiation such as color, shape, location, and/or labeling needed to be included,

10.2.4 Legibility

Legibility is defined as the ability of an observer to discriminate visual stimulus details to such a degree that it can be recognized. Legibility refers to the perceptual clarity of visual objects. It is influenced by the method of display generation, application of human factors guidelines for correct depiction of the object in relation to the task requirements, the environmental conditions, and eyesight standards. Legibility of text is often defined in terms of readability. Readability is the relative ease with which text can be read and understood when characters are arranged in words, sentences, and paragraphs.

- Displays should be legible under all expected spaceflight conditions where reading/interpretation of the displayed information will be required.

10.2.4.1 Legibility Methods

Legibility is often defined in practice by the criteria and methodologies that are used to investigate it. In Pyke’s review of legibility research from 1825 to 1926, he surveyed more than 100 studies and discovered 15 different methods employed by researchers for measuring legibility (Pyke, 1926). The methods described were: speed of reading (by the time threshold and

amount read), the distance threshold (direct and peripheral), “eye-span.” “illumination threshold,” focus threshold, fatigue, number of eye-pauses, number of eye-refixations, regularity of eye-movements, reading rhythm, “legibility coefficient,” “specific legibility,” size of letters, “judgment of the trained human eye,” and aesthetic merits.

In *Legibility of Print*, published in 1963, Tinker presented a more condensed list of investigative criteria, representative of those most commonly employed:

1. *Speed of perception*: The speed and accuracy with which characters can be perceived in a short period of exposure.
2. *Perceptibility at a distance*: The distance from the eyes at which characters can be accurately perceived.
3. *Perceptibility in peripheral vision*: The distance from a given “fixation point” at which a character can be accurately perceived in the periphery.
4. *Visibility*: A measure of the point at which characters can be perceived when viewed through a visual apparatus that uses rotating filters to obscure and clarify those characters.
5. *The Reflex Blink Technique*: Frequency of blinking when reading text with different typographical characteristics.
6. *Rate of Work*: Includes such measures as “speed of reading, amount of reading completed in a set time limit, time taken to find a telephone number, time taken to look up a power or root in mathematical tables, and work output in a variety of situations which involve visual discrimination.” It is a measure of the speed of reading, controlling for comprehension.
7. *Eye Movements*: Measure of the movements of the eyes when reading, using methods such as corneal reflection and electrical signals.

However, no single one of these methods (or criteria, depending on how they are described) is adequate for measuring legibility in all of its aspects. Each has to be understood and considered on its own merits as contributing to a broader notion of legibility.

Based on the listed criteria, the legibility methods can be grouped in these three major categories:

1. Size thresholds (visual acuity) for letter identification, measured with 5-letter strings presented on a video monitor, using an up-down staircase method (Levitt, 1971) with 0.05 log unit size steps. Size (or, inversely, distance) thresholds are probably the most common method for assessing text legibility (Tinker, 1963), and are widely used in applied settings such as highway signage, with lower size thresholds indicating higher legibility. Studies may use different kinds of stimuli: random strings of all lower-, all-upper, and randomly selected case and 5-letter words, all upper- or all lower-case, randomly selected from the 2110 most frequent 5-letter words in English (Francis, Kucera, & Mackie, 1982).
2. Reading speeds using Rapid Serial Visual Presentation (RSVP). Higher legibility, by this criterion, allows faster reading. Some studies measured reading speed using RSVP with small (two times acuity size) and large letters (roughly 10 times acuity size), using both all upper-case and conventional mixed-case text. Reading speed is a less-common

measure of legibility, but it is perhaps more representative of ordinary reading than is size threshold. Because RSVP can support extremely high rates of reading, it has the potential to be more sensitive to subtle differences in legibility. RSVP reading was tested with individual sentences, whose speed was varied to determine the speed that supported a 50% correct (of words) reading rate.

3. Reading speeds using continuous reading of text passages taken from standardized tests (9th grade level). This method can address possible differences between reading speeds with RSVP with those more commonly observed with continuous reading.

10.2.4.2 International Standards on Legibility

The *ISO 9241-11 Ergonomic requirements for office work with visual display terminals (VDTs) - Part 11: Guidance on usability* document proposes the following task and context to measure legibility:

- Read system messages and instructions displayed on a screen.
- Use a range of illumination levels from 50 lux to 5000 lux.
- Be able to read at least 98% of words used in system messages and instructions correctly at normal viewing distance.
- Measure legibility with users who have normal or corrected-to-normal vision.

10.2.5 Research Needs

The importance of usability, simplicity, consistency, and legibility has been discussed in the sections above. For the spaceflight domain, research is still needed to develop objective metrics and verification methods for these constructs, as well as unobtrusive methods of assessing these *in situ* during a spaceflight mission.

10.3 DISPLAY DEVICES

With the growing importance of complex information processing, display devices have become an ever-present part of all user interfaces with space systems. For this reason, their performance can have major impacts on the safety and efficiency of space missions.

In this section, the term *display device* is restricted to electro-optical displays that render text, graphics, and video on a surface. Typical examples are computer monitor displays and television displays.

Topics discussed in this section include display metrics and related human factors standards, and display acquisition, identification, and interpretation. Additionally, various current and emerging display technologies, and their distinctive attributes, are discussed.

10.3.1 Display Metrics

In specifying displays, it is useful to consider three levels of attributes. At the most fundamental level, are attributes of the display itself, such as brightness, contrast, and resolution. At the next level are attributes of the content of the display, such as text, symbols, icons, graphics, color sets, and video. At the third and highest level are attributes relating to the layout of display content, relating to concepts such as partition of the display with windows, and placement of user interface elements such as menus. In this section, the focus is primarily on the first level of attributes, along with a few attributes from the second level.

Attributes such as weight, volume, or power are not visual and are not considered here. The metrics are organized into seven categories. For each metric, there is a definition, a rationale, and references to existing standards in addition to caveats that should be considered when specifying metric values as part of a standard.

After each metric category, a brief table of related standards is provided. For ease of reference, in the text and the tables abbreviated names are used for the existing standards documents that are referred to most frequently.

10.3.1.1 Types of Display Metrics

A number of different types of human factors metrics exist for displays. Physical metrics are measurements of purely physical aspects of the display, such as horizontal resolution in pixels. Psychophysical metrics are derived from physical measurements, but are processed to reflect human visual sensitivity. Examples are luminance, contrast, and most color measurements. Subjective metrics involve application of a visual judgment to a display by a human observer or group of observers. An example is subjective evaluation of the existence of display flicker. Performance metrics are evaluations of the utility of the display in a target application. For example, rather than specifying the contrast and resolution of the display, one might specify that it must be legible, with a method for assessing legibility that involves reading text (Boschmann & Roufs, 1997).

Model-based metrics are an extension of psychophysical metrics (described above). They are distinct only in the complexity of the psychophysical model on which they are based. For example, recently proposed metrics for visibility of display defects (mura – see 10.5.2.4.8), or of motion blur, incorporate somewhat complex models of visibility of spatial patterns (Watson, 2006). Other examples are the Square-Root Integral metric of Barten (Barten, 1987) and the just noticeable difference (JND) model of Carlson and Cohen (Carlson & Cohen, 1980).

10.3.2 Viewing Conditions

These metrics do not describe the display itself, but factors outside of the display that affect its quality, such as the position of the viewer and surrounding illumination.

10.3.2.1 Viewing Distance

The viewing distance is the distance from an eye of the observer to the center of the display (Figure 10.3-1). It is important because it determines the angular size of the display, and thus the visual resolution of the display. It also determines the range of gaze angles to various points on the display. These quantities in turn have a powerful impact on the quality of the display. The angle subtended by an object of height H viewed on a surface orthogonal to the line of sight from distance D to the center of the object is

$$\alpha = 2 \tan^{-1} \frac{H}{2D}$$

Viewing distance varies considerably, and depends on the type of display and the application. For example, televisions are typically viewed from greater distances than are computer monitors. For many applications (e.g., television) the range of actual viewing distances adopted by users is very large. Nonetheless, for standards that measure spatial quantities, a specific viewing distance (sometimes called the “design viewing distance”) is often adopted. For example, the certification standard TCO’05 adopts a viewing distance of 1.5 times the diagonal for “notebook” displays, and TCO’06 adopts 4 times the height for “media” displays. For flat-panel displays, TCO’03 adopts 1.5 diagonals, but as a measurement distance. The Human Factors and Ergonomics Society (2007) standard assumes a “default” viewing distance of 50 cm. The ISO13406-2 standard states that design viewing distance should be not less than 40 cm, but allows a 30-cm distance for certain applications such as touchscreens. Historically, NASA-STD-3000 suggested a minimum viewing distance of 33 cm, with a preference of 51 cm.

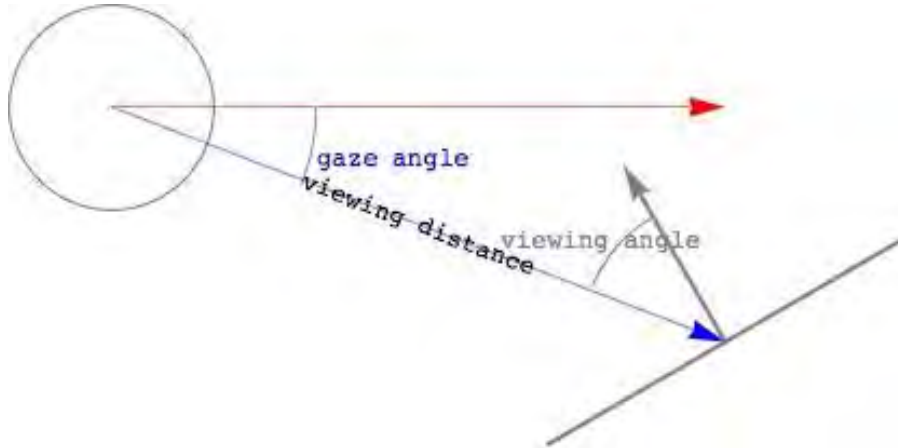


Figure 10.3-1. Gaze angle, viewing angle, and viewing distance.

Optimal viewing distance for a display is determined by many factors, including the desired field of view, the visual resolution required (which is based on the expected content), human visual system limitations (such as accommodation), and specific extraneous design requirements (such as those for helmet-mounted displays). Accommodation limits suggest a minimum viewing distance (for a direct-view display) of 40 cm (see Human Factors and Ergonomics Society (2007) for a discussion).

It is important to understand that viewing distance will determine the visual significance of every display metric that incorporates a spatial aspect (e.g., resolution, mura, motion blur, image retention, uniformity). Thus, whereas many metrics are expressed independently of viewing distance, they are not ergonomic, or human factors, or display quality standards until viewing distance is taken into account.

10.3.2.1.1 Gaze Angle

Gaze angle refers to the angle of the eye with respect to the straight-ahead position, as shown in 10.3-1. The vertical angle is usually taken with respect to the so-called Frankfort plane. The extensive literature on preferred gaze angle for displays (summarized by Psihogios, Sommerich, Mirka, & Moon, 2001) does not provide compelling evidence of an advantage for either positive or negative angles.

Human Factors and Ergonomics Society (2007) suggests the display area lie within gaze angles of 0° to -60° , and that the display center be at about -17° . International Organization for Standardization (ISO) 1992 recommends a gaze angle of between 0° and -60° , and ISO 2001 recommends 0° to -45° .

10.3.2.1.2 Viewing Angle

Viewing angle (Figure 10.3-1) is the angle between a normal (perpendicular line) at the center of the display surface and a line from the same point to the eye (or light measurement device). Positioning of the display relative to the user will affect viewing angle. Displays may perform differently at different viewing angles, and this general matter is described as viewing angle performance, which is discussed below. Viewing angle performance may be especially important in 0g, since the viewer may be at an arbitrary angle relative to the display.

10.3.2.1.3 Ambient Light

The ambient lighting environment in which displays operate has a profound effect on both the displayed image and the visual sensitivity of the observer. Incident ambient illumination reflected from display surfaces can strongly affect the overall luminance, contrast, and color of displayed imagery. Also, the visual sensitivity of an observer is modulated by the state of visual adaptation, which in turn is partly determined by the ambient illumination.

Sources of illumination in the operating environment are defined by their spectral power distribution (SPD) and their overall level of photopically-weighted optical power or radiance integrated over a range of wavelengths from approximately 380 to 780 nanometers (nm). Illumination is typically specified in base units of lux (lx), which are defined as flux in lumens (lm) incident on a unit area of one square meter (m^2). Space environments may involve distinctive ambient light environments, with respect to intensity, SPD, and timing (e.g., 90-minute day / night cycles in low Earth orbit).

10.3.2.1.4 Reflections

Three basic types of reflection can be identified according to the amount and type of scattering introduced during reflection. If no scattering occurs, the reflection is designated as regular or specular and is typified by the reflection produced by a mirror or a mirrorlike smooth surface. If

the incident illumination is completely and uniformly scattered, such as by a ground-glass surface or paper, this type of reflection is designated as diffuse or Lambertian reflection. The third type of reflection is essentially a combination of specular and diffuse reflections in that scattering is constrained, with the maximum of reflected intensity in the specular direction, and decreases with angular separation relative to the beam of illumination. This type of reflection is typically known as haze. Figure 10.3-2 illustrates the geometry of illumination and reflection and the angular characteristics of the three basic types of reflection (Becker, 2006).

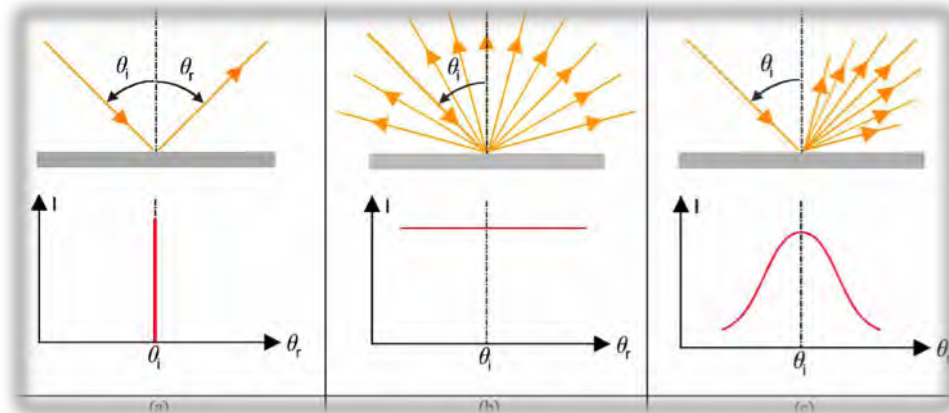


Figure 10.3-2. The three basic types of reflection. Upper panels show geometric relations of illumination and reflection. Lower panels show the angular distribution of reflected light for a beam incident at a right angle to the surface. (a) specular reflection; (b) diffuse or Lambertian reflection; (c) haze.

When defining the display technology and performance specifications for any display application, it is important to consider the inherent reflectance characteristics of the type of display as well as any optical surface treatments included to manage display reflections. A variety of mixtures of the three basic types of reflection can be found in electronic displays: for example, cathode ray tubes (CRTs) generally feature a superposition of Lambertian and specular components (no haze); plasma display panels (PDPs) typically generate reflections containing Lambertian, specular, and haze components; and liquid crystal displays (LCDs) often combine various types of haze, sometimes including minor specular components, but usually without the Lambertian component of reflection. These typical reflection characteristics result from a combination of the inherent optical properties of the different technologies and the surface optical treatments commonly applied to each technology. Therefore, the reflection characteristics of any display technology can be significantly altered by suitable modifications of the display itself or variations in surface optical treatments. Figure 10.3-3 further illustrates the three basic types of reflection by themselves and in various combinations (Kelly, 2006).

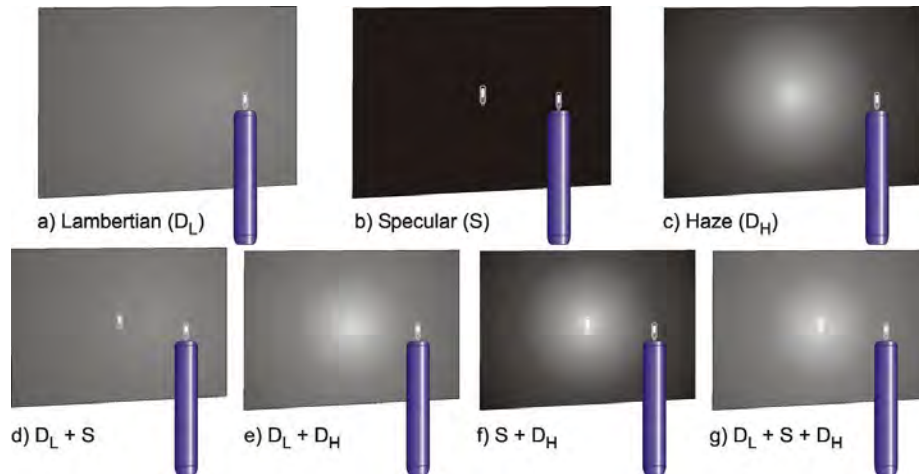


Figure 10.3-3. The three basic types of reflection and their separate and combined effects on a display surface.

10.3.2.1.4.1 Measuring Reflections

Many different approaches and methods are used for measuring reflections from material surfaces and displays (American Society for Testing and Materials (ASTM), 1987; Commission Internationale de L'Eclairage (CIE), 1977, 1979, 1987; Video Electronics Standards Association (VESA), 2001). Reflectance is generally defined as the ratio of the reflected flux to the incident flux for a given geometry of source and detector. All display reflection measurements are defined by the characteristics of the illumination source and detector as well as the geometric relations between source, detector, and display sample. Figure 10.3-4 illustrates two possible geometries for measuring specular and diffuse reflectance (Kelly, 2006).

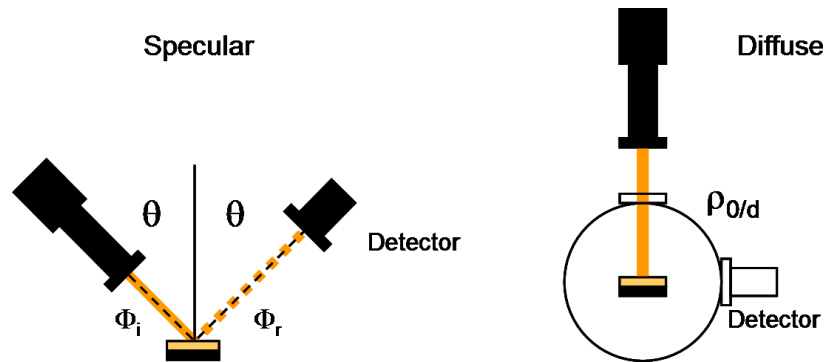


Figure 10.3-4. Two sample measurement geometries for specular and diffuse reflectance.
The diffuse reflectance measurement uses an integrating sphere.

Recently, more complex and comprehensive methods for characterizing display reflectance based on the bidirectional reflection distribution function have been proposed, and such methods are capable of providing the complete reflectance profile of displays including specular, diffuse, and haze components (American Society for Testing and Materials, 1987; Becker, 2006; Kelly,

2006). Regardless of the method of measuring reflectance, it is important to recognize that the measurement and interpretation of display reflectance are application-dependent.

- The display technology, optical surface treatments, and illumination and sensor (viewing) geometries should represent the application environment as closely as possible.

10.3.2.1.4.2 Impact of Reflections on Displayed Images

Incident ambient illumination reflected from display surfaces can strongly affect the overall luminance, contrast, and color of displayed imagery. For most types of displays, reflection of incident ambient illumination will result in the addition of luminance to both the image and the display background. Display luminance will increase as a result of the additional luminance produced by reflected ambient illumination, while display contrast will decrease. The principal effect of reflected ambient illumination on the color of displayed imagery is a decrease in color saturation, at least for broadband illumination such as sunlight or relatively neutral artificial illuminants.

- The ambient luminance, contrast, and color gamut of displays should be estimated for the intensity levels and SPDs expected in the display application environment.

Figure 10.7-8 provides examples of how the color gamut for a display with sRGB (standard red-green-blue color space) color primaries changes when the environment changes from a nominal or dark ambient environment to one in which a high level of broadband illumination is incident on the display surface. The incident illumination reduces the display's contrast ratio and color saturation, reducing the effective color gamut of the display.

10.3.2.1.4.3 Optical Treatments to Reduce Reflections and Glare

A variety of optical treatments may be used to reduce reflections and glare from displays. Contrast enhancement filters are often used to improve the contrast of emissive-type displays with high levels of diffuse reflectance, such as the reflectance produced by illumination incident on the phosphor surfaces of CRTs or color PDPs. Most contrast-enhancement filters are neutral-density filters that achieve their effects by attenuating the incident illumination and associated reflected luminance on two passes through the filter, while the emitted display luminance undergoes attenuation with only a single pass through the filter. The performance tradeoff of the resulting enhancement of contrast is, of course, the reduction of displayed image luminance. A challenging but important requirement for all displays that operate in any appreciable illumination environment is the reduction of front-surface reflections.

- Specular front-surface reflections are often the most intense and troublesome and should be avoided as much as possible by placement and shielding of the display and adjustments of the viewing geometry.
- Where front-surface reflections cannot be mitigated by such means, anti-reflection and/or anti-glare surface treatments should be used.

10.3.2.1.5 Adaptation

As noted in section 5.4 Visual Perception, the human visual system (HVS) operates over a range of about 14 log units of light intensity, but is sensitive to a much smaller range of about 2 log

units at any one time. The process of light adaptation shifts the range of sensitivity to the prevailing ambient level.

Light adaptation is determined by the luminance of objects in the operating environment, including the display, and the pattern and duration of an observer’s eye fixations on those objects. Steady-state adaptation, in which an observer is adapted to the prevailing luminance of the fixated field of view (FOV), determines an observer’s incremental or decremental contrast threshold and overall contrast sensitivity. Transient visual adaptation occurs as a result of changes in visual fixation. It has important implications for the visibility of information in dynamic and complex illumination environments, especially when the difference in the prevailing luminance levels of the alternately fixated FOVs exceeds approximately 2 log units. Transient light adaptation resulting from increases in the prevailing luminance of the FOV is relatively rapid, while transient dark adaptation resulting from decreases in the prevailing luminance of the FOV is relatively slow. Transient visual adaptation can have profound effects on the time course of display visibility and thus on luminance and contrast requirements for displays operated in dynamic viewing environments, such as those for vehicular applications, as well as mobile computing and communications (Krantz, Silverstein, & Yeh, 1992; L. D. Silverstein, 2003; Louis D. Silverstein & Merrifield, 1985).

10.3.2.1.6 Effect of Sunglasses on Display Viewing

The use of sunglasses in a display application environment reduces the level of observer adaptation as well as the effective intensity of all illumination sources and luminous surfaces in the environment.

- Whereas sunglasses can be a very effective aid to vision and promote visual comfort in very bright environments, they should generally be of a neutral-density type to avoid significant changes in the chromaticity of displays.
- In addition, the use of polarized sunglasses should generally be avoided in display application environments that use LCDs that produce linearly polarized light output or in displays that use circular polarizing filters for control of front-surface reflections.

10.3.2.1.7 Viewing Conditions: Related Standards

Table 10.3-1 Viewing Condition Standards

Standard	Section	Topic
Viewing distance		
Human Factors and Ergonomics Society (2007)	7.2.2.1	Design viewing distance
Human Factors and Ergonomics Society (2007)	7.2.1	Default configuration
TCO '05 Notebooks	A.2.1.1	Native pixel array requirements
TCO'06 Media Displays	A.2.1.1	Pixel array requirements
TCO'03 Flat Panel Displays	B.2.0.5	Measurement distance

Standard	Section	Topic
ISO, 2001	7.1	Design viewing distance
NASA-STD-3000	9.4.2.2	Visual display design considerations
NASA-STD-3000	9.4.2.3.3.9g	Viewing distance and angle
Gaze angle		
Human Factors and Ergonomics Society (2007)	7.2.2.2	Gaze angle
ISO, 2001	3.3.5	Frankfort plane
ISO, 2001	3.3.6	Gaze angle
ISO, 2001	7.4	Gaze and head-tilt angles
ISO, 1992	5.2	Line-of-sight angle
Reflections		
Human Factors and Ergonomics Society (2007)	7.2.5.3	Luminance contrast and reflections
ISO, 2001	7.3	Design screen illuminance
ISO, 2001	7.17	Reflections
ISO, 2001	7.17.1	Contrast in the presence of reflections
ISO, 2001	7.17.2	Contrast of unwanted reflections
TCO'03 VDU of CRT Type	A.2.5.1 / B.2.5.1	Front frame reflectance
TCO'03 VDU of CRT Type	A.2.5.2 / B.2.5.2	Front frame gloss
TCO'03 FPD	A.2.5.1 / B.2.5.1	Front frame reflectance
TCO'03 FPD	A.2.5.2 / B.2.5.2	Front frame gloss
MIL-STD-1472F	5.2.1..4.4	Reflection
MIL-STD-1472F	5.2.1..6.2.2	Reflected glare
MIL-STD-1472F	5.2.1..6.2.3	Adjacent surfaces
MIL-STD-1472F	5.2.1.5.6.3	Dark adaptation
MIL-STD-1472F	5.2.4.2.1	Luminance
MIL-STD-1472F	5.2.4.2.2.2	Extreme ambient illumination
MIL-STD-1472F	5. 2.4.2.3	Luminance of adjacent surfaces
MIL-STD-1472F	5. 2.4.2.4	Ambient illuminance
MIL-HDBK-87213	3.2.1.17	Reflections
MIL-HDBK-87213	4.2.1.17	Verification of reflections

Standard	Section	Topic
VESA (2001)	308-1	Reflection with diffuse illumination
VESA (2001)	308-2	Ambient contrast ratio
VESA (2001)	308-3	Large-source diffuse reflectance
VESA (2001)	308-4	Large-source specular reflectance
VESA (2001)	308-5	Small-source specular reflectance
VESA (2001)	A214	Illuminance from luminance
VESA (2001)	A215	Illuminance inside an integrating sphere
VESA (2001)	A216	Reflection from room walls onto screen
VESA (2001)	A217	Reflection models

10.3.2.2 Luminance and Contrast

10.3.2.2.1 Luminance

The luminance of a display is one of the critical performance parameters that define the efficacy of a display in stimulating human vision. Luminance is closely related to the subjective sensation of brightness. In general, brighter displays are better, as they retain their contrast and saturation in brighter ambient illumination.

The display luminance can be measured and specified in a variety of ways.

- In most cases standard units of luminance, cd/m², should be used, and measurements should be made normal to the display surface.

For some technologies, such as CRTs, the area of the screen that is illuminated may affect the maximum luminance measured, because of power supply loading.

10.3.2.2.1.1 Maximum Display Luminance

The maximum or peak luminance of a display determines the upper limit of the range of ambient illumination and visual adapting conditions in which a particular display may effectively operate. Maximum display luminance is the numerator in the display contrast ratio (see below) and as such also defines the upper end of the dynamic range of a display. The display dynamic range in turn determines the number of discriminable intensity steps or gray levels that can be rendered by a display.

For monochromatic displays, maximum display luminance is simply the peak luminance achievable with the single SPD produced by the display. For color displays, maximum display luminance is typically specified as the peak luminance that can be achieved for a selected white-

point chromaticity. The maximum luminance of a color display is therefore often designated as white luminance or peak white luminance. When reflective displays are considered, the maximum luminance can be meaningfully defined for only a specified illuminant and is often characterized as a proportion of reflected luminance relative to a reflectance standard under the specified illuminant.

Typical maximum display luminance will depend on the display technology and the intended application, but common current (2007) examples are 400 to 600 cd/m² for LCD television, 250 to 500 cd/m² for computer monitors, and 150 to 400 cd/m² for notebook displays.

10.3.2.2.1.2 Minimum Display Luminance

The minimum luminance of a display is also designated as the black level or background level of the display. It is the luminance produced when the display is driven to its darkest level or off state. From a human factors viewpoint, the minimum luminance is important because it determines the maximum obtainable contrast on the display. Minimum display luminance is the denominator in the display contrast ratio. Since the minimum display luminance is effectively the background luminance of the display, it is strongly affected by the reflectivity of the display and the level of ambient illumination.

Display technologies vary greatly in the minimum luminance that they are able to achieve. Self-luminous or emissive displays such as PDPs generally have a lower black level than non-emissive technologies such as LCDs. This is due to the fact that the former can be fully deactivated by removal of driving voltage or current while the latter modulates illumination from a backlight and is subject to residual light leakage.

Measurements and specifications for minimum display luminance are typically defined for a dark ambient environment where little or no incident illumination of the screen is present. However, for some display applications it may be more meaningful to characterize the minimum display luminance under a defined set of ambient illumination conditions.

10.3.2.2.1.3 Gamma and Grayscale

All display devices have a characteristic transfer function that relates display input values to display output. Display input values are typically expressed in device-independent digital values. The display transfer function is generally a nonlinear function and is often characterized by a power function with an exponent of gamma, and is often called the “gamma function.” The exponent gamma is usually in the range of 1.5 to 2.5. Although this gamma function is a legacy of the CRT, it is an advantageous coding scheme since unit input steps yield approximately equal steps of brightness. As a result, most modern displays adopt a similar transfer function.

In a digital imaging system, the number of bits determines the number of gray levels available; for example, 8 bits yields 256 gray levels. The actual luminance produced by each of those gray levels will be determined by the gamma function. The number of gray levels affects the quality of the display. If the steps between gray levels are too large, the intended image cannot be produced, and artificial contours will appear. The number of levels required for an artifact-free display depends largely on the contrast ratio of the display: larger ratios require larger numbers

of gray levels to ensure that the contrast step between gray levels is below threshold. The required number of gray levels depends on the task: photographic images may require 8 bits, while text and simple graphics may require fewer. While 8 bits has usually been found sufficient for the first generation of digital displays, new displays with very high contrast ratios may require greater numbers of gray levels.

For color displays these considerations apply to each of three color channels. Displays are often specified in terms of the number of colors available. Thus a display in which each color has 6 bits would have $2^{(3 \times 6)} = 262,144$ colors.

10.3.2.2.2 Contrast

In general terms, contrast refers to a ratio of luminances of different points in a display. The ability of a display to generate large contrasts is one of the most significant contributors to the quality of a display. It is in many respects more significant than the peak luminance of the display. This is because the human visual system adapts to the average luminance, and responds only to changes from the adapted level. In effect, the visual system converts the luminance signal into a contrast signal, and as a consequence visual performance is more nearly constant with respect to contrast than with respect to luminance.

It is useful to distinguish between the overall contrast of the display and the contrast of content rendered within the display. The former is usually measured by comparing the luminances of white and black, while the latter compares the luminances of points within display content, with gray levels that may be other than black and white.

Display contrast is often measured in the dark, but in actual use display contrast may be profoundly affected by ambient illumination. A diffuse ambient illumination, in concert with a particular reflectivity of the display, will add a veiling luminance to the display. This will add to the luminances of both black and white, and thereby reduce display contrast. The greater the peak luminance of the display, and the lower its reflectivity, the less effect ambient illumination will have. Thus the dark-room contrast of the display, the ambient light environment, and the reflectivity of the display combine to determine actual display contrast.

Different definitions of contrast are used in different contexts. These are described below. Some of the quantities involved are pictured in Figure 10.7-1.

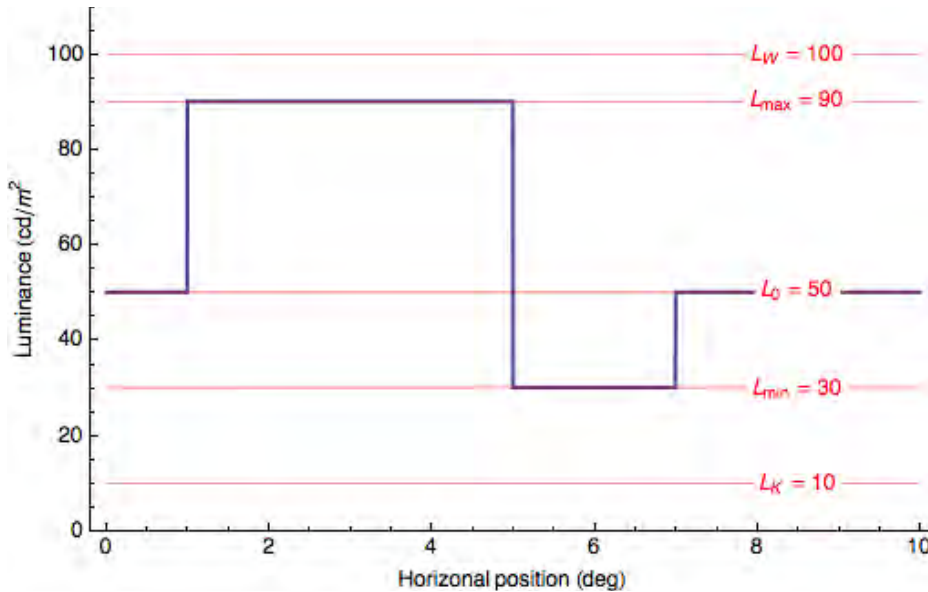


Figure 10.3-5 Illustration of quantities related to luminance contrast. The points show luminance in a one-dimensional luminance pattern on a hypothetical display. LW, luminance of white; Lmax, maximum luminance of the display element; L0, background luminance; Lmin, minimum luminance of the display element; LK, luminance of black.

10.3.2.2.2.1 Contrast Ratio

The most common definition used to characterize displays is the contrast ratio CR

$$(1) \quad C_R = \frac{L_W}{L_K}$$

where LW and LK are the luminances corresponding to white and black. Unless otherwise stated, this is assumed to be recorded in a dark room, so that only light emitted by the display is measured. Without ambient light, for an emissive display LK can be very close to zero, and the ratio can reach very large numbers. Although low values of LK (dark blacks) yield an attractive display, it is unlikely that perceived quality rises in proportion to the contrast ratio. Also, it is rare that displays are viewed in the absence of any ambient light, so the actual viewed contrast ratio will be much lower. In the example in Figure 10.7-1, the contrast ratio is $100 / 10 = 10$. For current (2007) LCD monitor and TV displays, contrast ratios of 1,000 to 2,000 are commonplace.

The contrast ratio is also sometimes used to describe content, such as the contrast of a character relative to its background. In that case, the contrast ratio would be the absolute value of the ratio of character luminance to background luminance.

10.3.2.2.2.2 Michelson Contrast

The Michelson contrast is a measure used primarily to describe the contrast of an element of content on a display, such as an alphanumeric character. It is defined as

$$(2) \quad C_M = \frac{L_{\max} - L_{\min}}{L_{\max} + L_{\min}}$$

where L_{max} and L_{min} are the maximum and minimum luminances of the display element. In the example in Figure 10.7-1, the Michelson contrast of the pattern is $(90 - 30) / (90 + 30) = 60 / 120 = 1/2$.

10.3.2.2.2.3 Image Contrast

In a complex image, neither the contrast ratio nor the Michelson contrast definitions are useful. Instead, the concept of image contrast, as defined for a luminance image $L(x,y)$ with some agreed-upon background luminance of L_0 , is

$$(3) \quad C(x, y) = \frac{L(x, y) - L_0}{L_0}$$

In some contexts, the value of L_0 is specified as L_0 the luminance of a mid-gray (128); in other contexts it may be taken as a specific background luminance, or as the mean of all the gray levels in the image.

The peak image contrast of the image is then defined as the maximum of the absolute value of $C(x,y)$:

$$(4) \quad C_p = \text{Max}(|C(x, y)|)$$

For images in which the gray levels are distributed symmetrically about L_0 , $C_p = C_m$. An example is a sinusoidal grating with a mean level of L_0 . In the example of Figure 10.7-1, the image contrast ranges from $(90 - 50) / 50 = 0.8$ to $(30 - 50) / 50 = -0.4$, and thus the peak contrast is 0.8.

10.3.2.2.2.4 Contrast Energy

Although it is not yet widely used in display standards, the concept of contrast energy is useful in quantifying the visibility of displayed information. It takes into account the area over which the contrast is distributed, and the shape of that distribution. It is defined as the integral of the image contrast squared, and has units of degrees squared for a three-dimensional (3D) pattern of space and time. For the one-dimensional (1D) example in Figure 10.7-1, the pattern has a contrast energy of $(0.8)^2 (4) + (-0.4)^2 (2) = 2.88$ degrees.

On photopic backgrounds, the lowest contrast energy thresholds are about 10^{-6} degrees² (A. B. Watson, Barlow, & Robson, 1983).

10.3.2.2.2.5 Visible Contrast Energy

Not all contrast energy is equally visible; energy near the peak of the contrast sensitivity function is much more visible than energy at high spatial frequencies. Visible contrast energy is defined as contrast energy weighted by a contrast sensitivity function,

$$(5) \quad VCE = \iint_{x,y} (h(x, y) * c(x, y))^2 dx dy$$

where $h(x,y)$ is the impulse response corresponding to a contrast sensitivity function. Specific examples of the function are available (A. B. Watson & A. J. Ahumada, Jr 2005).

10.3.2.2.2.6 Ambient Contrast

Ambient contrast is the ratio between luminances of white and black when the display is measured in the presence of typical amounts of diffuse ambient illumination. An amount of 500 lux is often used to simulate an office environment. As previously noted, the dark-room contrast ratio assumes no ambient illumination, and consequently does not reflect the apparent contrast of displays when they are viewed in common situations that include some amount of ambient illumination. Ambient contrast is designed to provide a more realistic measure of the apparent contrast of a display in real-world situations. If the display pictured in Figure 10.7-1 were viewed in a diffuse ambient illumination that added a luminance of 10 cd/m² to the screen, then the ambient contrast ratio would be $(100 + 10) / (10 + 10) = 110 / 20 = 5.5$.

10.3.2.2.2.7 Dynamic Contrast

On some displays (e.g., LCDs with controllable backlight) the overall gain of the display can be changed over time. This allows, for example, a dark scene to be rendered more faithfully by turning down the backlight and amplifying the gray levels. This allows a new measure of contrast ratio, in which LK is measured with the backlight dimmed and LW is measured with the backlight at its brightest. The obtained ratio bears little relation to the static contrast ratio, and may be of questionable value since it cannot be obtained in a single frame of the display.

10.3.2.2.2.8 Existing Standards for Contrast

The National Aeronautics and Space Administration (1995) requires that indicators have a contrast of 0.5, except for displays viewed in sunlight. In applications where ambient light is low, contrast should be 90%. For projected displays, a contrast ratio (called “luminance ratio”) of 200 is required, while for various display elements, values of between 5 and 100 are required. On an alphanumeric video display terminal, the Michelson contrast of characters is required to be between 0.88 and 0.9. No rationale is provided for these numbers.

TCO’03, TCO’05, and TCO’06 require the display to have the capability of displaying characters with Michelson contrast of 0.7. ISO (2001) provides a formula for required contrast that ranges between about 0.45 and 0.75. Human Factors and Ergonomics Society (2007) indicates a default configuration with ambient contrast ratio of 10. In addition it requires an ambient contrast ratio of at least 3 under all office illumination conditions.

10.3.2.2.3 Luminance and Contrast: Related Standards

Table 10.3-2 Luminance and Contrast Standards

Standard	Section	Topic
Gamma and grayscale		
TCO’03 FPD	A.2.6.5 / B.2.6.5	Color Greyscale Linearity
VESA (2001)	302-5 302-7 304-4	Grayscale of Full Screen Full-Screen Grayscale Color Changes Grayscale of Centered Box

Standard	Section	Topic
	304-11 A209 A227	Grayscale-JND Relationship Nonlinear Response of the Eye NEMA-DICOM Grayscale
Luminance		
Human Factors and Ergonomics Society (2007)	7.2.5.1	Luminance Range
ISO, 2001	7.14 7.16	Display Luminance Luminance Balance
ISO/WD 18789-3	6.2.2 6.2.3	Display Luminance Luminance Balance
TCO'03 VDU of CRT Type	A.2.3.1 / B.2.3.1 A.2.3.3/B.2.3.3	Luminance Level Image Loading Capacity
TCO'03 FPD	A.2.3.1 / B.2.3.1	Luminance Level
MIL-STD-1472F	5.2.1.6.2 5.2.1.6.2.1 5.2.2.18 5.2.4.2.1 5.2.5.3.3	Luminance Considerations Luminance Range Luminance of Transilluminated Displays Luminance of CRTs Image Luminance & Light Distribution
MIL-HDBK-87213	3.2.1.6 4.2.1.6 3.2.1.6.3 4.2.1.6.3	Display Luminance, Contrast & V-angle Verification of Display Luminance MFD Luminance & Contrast Verification of MFD Luminance
VESA (2001)	302-1 302-2 302-9 304-1 304-2 304-8 304-9 304-10	Luminance & Color of Full-Screen White Luminance & Color of Full-Screen Black Luminous Flux Luminance & Contrast of Centered Box Centered Box On-Off Luminance & Contrast Ratio Luminance Loading Checkerboard Luminance & Contrast Highlight Luminance & Contrast
Gamma and grayscale		
TCO'03 FPD	A.2.6.5 B.2.6.5	Color Greyscale Linearity
VESA (2001)	302-5 302-7 304-4 304-11 A209 A227	Grayscale of Full Screen Full-Screen Grayscale Color Changes Grayscale of Centered Box Grayscale-JND Relationship Nonlinear Response of the Eye NEMA-DICOM Grayscale
Contrast		
NASA-STD-3000	9.4.2.3.1.2	Display Contrast Design Requirements

Standard	Section	Topic
NASA-STD-3000	9.4.2.3.3.9	Visual Display Terminal Design Requirements
VESA (2001)	302.3	Darkroom Contrast Ratio of Full Screen
VESA (2001)	303-1	Line Luminance and Contrast
VESA (2001)	303-1	N × N Grille Luminance and Contrast
VESA (2001)	304-1	Luminance & Contrast of Centered Box
VESA (2001)	304-2	Centered Box On-Off Luminance & Contrast
VESA (2001)	304-3	Transverse Contrast of Centered Box
VESA (2001)	304-9	Checkerboard Luminance & Contrast (n×m)
VESA (2001)	304-10	Highlight Luminance & Contrast
VESA (2001)	308-2	Ambient Contrast Ratio
VESA (2001)	A220	Measures of Contrast – A Tutorial
Human Factors and Ergonomics Society (2007)	7.2.5.3	Luminance Contrast and Reflections
ISO, 2001	7.15	Contrast
ISO, 2001	8.6	Combined Measurement for Luminance, Contrast and Diffuse Illumination
MIL-HDBK-87213	3.2.1.6	Display Luminance, Contrast, and Viewing Angle
TCO'03	A.2.4.1	Luminance Contrast – Characters
TCO'03	A.2.4.2	Luminance Contrast – Angular Dependence
TCO'05	A.2.4	Luminance Contrast Characteristics
TCO'06	A.2.4	Luminance Contrast Characteristics
TCO'06	A.2.4.1	Luminance Contrast – Characters
TCO'06	A.2.4.2	Luminance Contrast – Angular Dependence

10.3.2.3 Spatial Metrics

Visual information consists of light distributed over space, time, and wavelength. For some displays, such as still grayscale images, only the spatial dimension matters. Consequently the ability of a display to render arbitrary spatial patterns, up to some level of detail, is critical to its effectiveness and to its apparent quality. In matrix displays, the quality of spatial rendition is mainly determined by two quantities: the visual resolution of the display, and its freedom from blemishes and nonuniformity. Visual resolution is the term given to the resolution of the display expressed in pixels per degree of visual angle. This takes into account both the native resolution, for example in pixels per centimeter, and the viewing distance in centimeters.

Required values of visual resolution are ultimately determined by two factors: the display application and the limitations of human vision. As described in section 5.4, “Visual Perception,” human observers are unable to see spatial patterns above about 60 cycles per degree. To render this frequency requires a visual resolution of 120 pixels per degree. See (Klein & Carney, 1991), for discussion of the possibility of even higher requirements). At visual resolutions below about 30 pixels per degree, the pixel matrix itself may become visible, and depending on the

application, this may or may not be acceptable. Thus, in general, high-quality displays are characterized by visual resolution of between 30 and 120 pixels per degree. Below are typical visual resolutions for a number of display applications, which suggest that expectations, if not requirements, differ for different applications. For example, high-definition television (HDTV) displays with 1080 vertical pixels have a nominal viewing distance of three picture heights, which corresponds to a visual resolution of about 60 pixels per degree. A large-screen computer monitor, with 1600 vertical pixels, may be viewed at 1 picture height, for a visual resolution of close to 30 pixels per degree.

Specifying resolution purely in terms of pixel densities is appropriate so long as each pixel can be independently set to an arbitrary luminance within the range of the display. This is generally true for LCD and most other flat-panel displays. However, it is not true for displays in which illumination of one pixel location affects the illumination of adjacent pixel locations. This is the case for CRTs, in which the approximately Gaussian spot of the scanning beam may extend somewhat over several pixels. In such cases, the true resolution of the display can be determined using modulation transfer function (MTF) methods as discussed below.

In the sections below, the most prominent metrics of spatial display quality are defined. Many turn out to be variants of spatial resolution.

10.3.2.3.1 Pixel

Most contemporary displays are so-called matrix displays, in which imagery is created by controlling the color of individual pixels in a rectangular array. A pixel is defined by TCO'03 as "the smallest addressable imaging element of the flat panel display (FPD) capable of reproducing a full range of luminance and colors." In color displays, a pixel may be made up of smaller subpixels with distinct color properties.

10.3.2.3.2 Resolution

This is a confusing term, which is often used to describe the size of the display in pixels, and sometimes to describe the inverse of pixel pitch. In the latter case, quantities such as "dpi" (dots per inch) may be used. Below, a term – visual resolution – is discussed that is closer to the intuitive meaning of resolution as sharpness or fineness of detail. Also discussed below is the display MTF, which is a still more detailed measure of the spatial resolving power of the display. Other terms such as "size" or "definition" are also sometimes used to describe the number of pixels in the display matrix. A number of sizes have become industry standards with particular names. In Table 10.7-2 a number of the more common standard sizes are enumerated.

Table 10.3-3 Selected Standard Matrix Display Dimensions in Pixels

Name	Width × Height
VGA	640 × 480
SD	640 × 480
HD	1366 × 768
FullHD	1920 × 1080
XGA	1024 × 768
UGA	1600 × 1200
SXGA	1280 × 1024
UXGA	1600 × 1200
WUXGA	1920 × 1200
WQXGA	2560 × 1600
QSXGA	2560 × 2048

10.3.2.3.3 Pixel Pitch

Pixel pitch is defined as the distance between corresponding points (e.g., centers) on adjacent pixels. Where different, separate horizontal and vertical pitches may be specified, pitch is usually specified in millimeters (mm). The pitch of current (2007) LCDs can vary by as much as a factor of six, depending on application and expected viewing distance. Table 10.7-3 provides some current examples. Pitch is sometimes stated as “resolution” in pixels per inch. NASA-STD-3000 mandated a resolution of 67 lines per inch.

10.3.2.3.4 Visual Resolution

The visual resolution of a display is defined as the number of pixels (horizontal or vertical) per degree of visual angle. It is thus a function of both pixel pitch and viewing distance. Visual resolution V is given by

$$V = \left(\tan^{-1} D_p^{-1} \right)^{-1}$$

where D_p is the viewing distance in pixels (distance in millimeters divided by pixel pitch), and the arctangent is computed in degrees. Over the range of interest ($D_p > 100$), this can be accurately approximated by

$$V = \frac{D_p}{57.2957}$$

This measure can be computed separately in horizontal and vertical dimensions when they differ. To give some examples, Table 10.7-3 below shows six representative displays available from one large vendor in 2006. The viewing distances are only illustrative examples.

Table 10.3-4 Visual Resolution for a Number of Representative Displays at a Number of Viewing Distances.

Pixels (vertical)	Application	Pixel pitch (mm)	Viewing distance, H (cm)					
			1H	2H	3H	4H	6H	8H
320	Cell phone	0.126	5.6	11.2	16.8	22.3	33.5	44.7
480	Car navigation	0.190	8.4	16.8	25.1	33.5	50.3	67.0
768	46" TV	0.746	13.4	26.8	40.2	53.6	80.4	107.2
1080	46" TV	0.530	18.8	37.7	56.5	75.4	113.1	150.8
768	Notebook	0.297	13.4	26.8	40.2	53.6	80.4	107.2
1600	Monitor	0.251	27.9	55.9	83.8	111.7	167.6	223.4

A typical viewing distance is indicated in shaded cells.

A number of existing standards mandate particular visual resolutions. TCO'03 and TCO'05 mandate a "pixel density" of 30 pixels per degree or greater at a measurement distance of 1.5 diagonals, while TCO'06 mandates 30 pixels per degree at a viewing distance of 4H. Human Factors and Ergonomics Society (2007) specifies a "default configuration" with a pixel pitch of 0.3 mm and a viewing distance of 50 cm, which equates to 29 pixels per degree.

10.3.2.3.5 Modulation Transfer Function

The Modulation Transfer Function (MTF) is a standard method for measuring the ability of a display to render spatial imagery of specified fineness. In its purest form, a one-dimensional sinusoidal grating pattern of nominal full contrast and a specific spatial frequency is rendered on the screen, and the resulting rendered contrast is measured. The measurement is repeated at a number of spatial frequencies to obtain a function relating contrast modulation to spatial frequency: the MTF. The VESA (2001) document offers a simplified method using an "N x N grille" consisting of alternating white and black lines, each n pixels wide. The MTF can be summarized by specifying the value of n at which the modulation falls to some threshold, such as 25%. Dividing the display resolution by that number then yields the resolution in number of resolvable pixels. For some displays, such as CRTs, this is a more accurate measure than the number of pixels.

For matrix displays that use discrete, non-overlapping pixels (such as LCDs), the MTF is of less value, since it will generally show a constant MTF up to the highest frequency (1/2 cycle per pixel). It is more commonly used with displays, such as CRTs, in which adjacent pixels overlap, and in which each pixel is defined by a smoothly varying function of luminance with respect to position.

10.3.2.3.6 Uniformity

Few if any displays exhibit fully consistent performance over their entire screen surface. Therefore it is important to characterize displays in terms of the spatial uniformity of various performance parameters. Luminance uniformity refers to a metric that characterizes how well display luminance remains constant (or varies) over the surface of the screen. For example, a luminance uniformity of 100% would indicate that the desired luminance is displayed at exactly the same level regardless of screen position, while a luminance uniformity of 90% would indicate that the display suffers from a relatively small deviation from perfect performance. In its most simple and general form, luminance uniformity may be defined as the percentage change from minimum to maximum luminance.

Various methods exist for sampling and analyzing luminance values as a function of screen position; they range from a sparse sampling of discrete screen positions to scanned area measures that provide a complete profile of luminance variation across the entire screen. Luminance uniformity may be defined for the maximum display luminance, minimum display luminance, and intermediate intensity levels or grayscale steps.

- The choice of metric for characterizing luminance uniformity should be based on the display application and the measurement resources available.

10.3.2.3.7 Mura

Mura (derived from the Japanese word for blemish) refers to localized screen defects such as dark or bright spots, smears, stripes, or streaks that are visible when the display is uniformly illuminated. It is usually distinguished from single pixel defects. At present, there is no agreed-upon metric to identify or quantify mura. A metric based on the Spatial Standard Observer (Watson, 2006) was developed recently. In that metric, the visible contrast energy of the blemish is measured in units of JND.

Though the two properties are usually treated separately, mura is closely related to nonuniformity. The two differ only in the band of spatial frequencies they consider: medium for mura and low for nonuniformity.

10.3.2.3.8 Pixel Fill Factor

Pixel fill factor is defined as the ratio of illuminated pixel area to total pixel area. This measure is meaningful only when the pixel is formed by well-defined areas (as in an LCD). The pixel fill factor, by itself, is not directly related to display quality, but may influence brightness, as well as the visibility of the display matrix. It is related to another metric, pixel grid modulation that describes the periodic modulation in luminance of a uniformly illuminated screen that is caused by the pixel structure of the display. ISO (2001) and Human Factors and Ergonomics Society (2007) require that if visual resolution is less than 30 pixels per degree, the fill factor must be greater than 0.3.

10.3.2.3.9 Spatial Metrics: Related Standards

Table 10.3-5 Spatial Metric Standards

Standard	Section	Title
TCO'03	A.2.1.1	Pixel array requirements
ISO13406	3.4.8	Pixel pitch
Human Factors and Ergonomics Society (2007)	7.2.3.2	Pixel pitch
NASA3000	9.4.2.3.3.9a	Resolution
VESA (2001)	303-7	Resolution from contrast modulation
Human Factors and Ergonomics Society (2007)	7.2.1	Default Configuration
ISO, 2001	7.1	Design viewing distance
TCO '05 Notebooks	A.2.1.1	Native pixel array requirements
TCO'06 Media Displays	A.2.1.1	Pixel array requirements
TCO'03 Flat Panel Displays	A.2.1.1	Pixel array requirements
MTF		
VESA (2001)	303-2	N × N Grille Luminance and contrast
VESA (2001)	303-7	Resolution from contrast modulation
VESA (2001)	A220	Measures of contrast – A tutorial
Uniformity		
Human Factors and Ergonomics Society (2007)	7.2.5.1	Luminance Range
	7.2.5.2	Luminance Nonuniformity
ISO, 2001	7.19	Luminance Uniformity
ISO/WD 18789-3	6.4.1	Luminance Nonuniformity
TCO'03 VDU of CRT Type	A.2.3.2 / B.2.3.2	Luminance Uniformity
TCO'03 FPD	A.2.3.2 / B.2.3.2	Luminance Uniformity
MIL-HDBK-87213	3.2.1.6.6	Luminance Uniformity
VESA (2001)	306-1	Sampled Uniformity & Color of White
	306-2	Sampled Uniformity of Black
	306-5	Sampled Uniformity of Dark Gray
Pixel fill factor		
ISO13406	3.4.1, 7.9	Fill factor
Human Factors and Ergonomics Society (2007)	7.2.3.2	Pixel Grid Modulation, Fill Factor
VESA (2001)	303-3	Pixel fill factor

10.3.2.4 Temporal Metrics

Current imaging displays are used to present both static and dynamic imagery. They achieve this by operating in a tachistoscopic mode: they present a rapid sequence of static images to the observer. The rate at which images are presented and the temporal properties of the display technology will affect the quality of the display. For example, temporal properties will determine whether the display appears to flicker, whether objects appear to move smoothly, and whether moving edges appear blurred.

As with the spatial dimension, temporal requirements are closely related to the temporal limitations of the eye. As noted in section 5.4 Visual Perception, human observers cannot see modulations of luminance more rapid than about 60 Hz. This is the basis for frame rates at around that value.

Another set of display attributes that relate to time are those that reflect the long-term temporal behavior of the display. For example, does the display take a long time to warm up, does it decline in brightness over the course of months, do persistent images become permanently “burned in” to the display, or do they “stick” for a long but finite interval?

Among current stroboscopic displays, there are two types that differ in their time course over the duration of a single frame. The first is a sample-type display, in which a given pixel is illuminated for only a fraction of the frame interval. The CRT is an example of a sample-type display. As the electron beam scans the raster, it visits each pixel in turn, producing a brief pulse of illumination, the brevity determined by the speed of the phosphor but almost always less than the frame time. In a hold-type display, a given pixel is usually illuminated for the entire duration of the frame. The LCD is an example of a hold-type display. The temporal behavior of a hold-type display is determined by the on- and off-response of the pixel, and also by the hold time.

10.3.2.4.1 Flicker

Flicker refers to an apparent periodic fluctuation in the brightness of a uniformly illuminated display. It is a result of the periodic illumination of the display by successive frames, and appears when the resulting luminance modulation over time exceeds the human visual threshold. That threshold is defined by the human temporal contrast sensitivity function, which is discussed in section 5.4 Visual Perception. This function depends on the size of the illuminated area, its retinal location, and the average luminance, but is typically zero at frequencies above about 70 Hz. Consequently flicker is rarely a problem at frame rates of that frequency or greater. Flicker can be measured subjectively, as described in VESA (2001) or Human Factors and Ergonomics Society (2007) section 7.2.4.3.

Conventional hold-type displays, such as LCDs, do not usually exhibit flicker, because the screen is not modulated for a constant gray level. However, recent techniques for ameliorating motion blur (see below) have the potential of producing flicker in hold-type displays.

10.3.2.4.2 Step Response and Response Time

This is a measure usually applied to hold-type displays, such as LCDs. It describes the temporal step response: the time required to turn on or turn off a given pixel. Because precise onset and offset times are hard to identify, on-time is usually defined as the time taken to transition from 10 to 90%. An example of the measurement of on-time is shown in Figure 10.7-2. A similar arrangement is used to measure off-time. Both on-time and off-time are usually measured, as they may differ. Response time is often specified as the sum of on-time and off-time. Response times can be measured in milliseconds or in frames. Detailed measurement methods are provided in VESA (2001). Response time has significant impact on the quality of dynamic displays, especially through the artifact known as motion blur, discussed below.

Figure 10.7-2 shows the response time between gray levels of 0 and 255 (black and white), but response time can be measured between any two gray levels and may differ markedly for different gray levels, so it is common practice to measure all possible transitions among a subset (e.g., 5) of gray levels. There is at present no agreed-upon method to combine these values into a single metric.

10.3.2.4.3 Motion Blur

On a hold-type display, imagery in motion exhibits motion blur. This happens because the imagery remains stationary during each hold time, while the eye moves continuously as it tracks a moving feature, resulting in motion of the feature across the retina. Motion blur can also occur on a sample-type display with a slow response (e.g., a CRT with a slow phosphor). Motion blur can produce highly blurred views of objects in motion. It is prominent in LCDs, but is also present in plasma displays.

Several techniques are being used to ameliorate motion blur on LCDs, and potentially other hold-type displays. Among these are “black insertion,” in which the pixel is turned off for a fraction of the frame-time; “overdriving,” in which the on-time is reduced by transiently driving the pixel beyond its final target value; use of a 120-Hz or higher frame rate with motion-interpolated imagery; and strobing the backlight, which can in principle make the LCD into a sample-type display. All of these techniques show promise but carry with them costs and potential artifacts.

Various methods have been proposed for measurement of motion blur. One method uses a “pursuit camera” to track the motion of an edge across the screen. The camera is synchronized so that the average position of the edge remains stationary on the camera. The motion of the camera is intended to simulate the motion of the eye as it pursues the moving edge. The result is a still image of the edge as it would be seen by a tracking eye. This image is usually converted into an edge profile, as shown in Figure 10.7-2.

A second method relies on the observation that under typical conditions the blurred edge profile can be obtained from the convolution of the step response and a pulse of width one frame (Watson, 2006). An example is shown in Figure 10.7-2. The black curve is the step response, and the gray curve is the edge profile. When computed in this way, the edge profile is usually expressed as a function of time. This can be converted to a function of space (pixels) by scaling

the time axis (in frames) by the speed of motion of the edge (in pixels per frame). Thus in the example shown, the horizontal axis can also be read as pixels, for a speed of 1 pixel per frame.

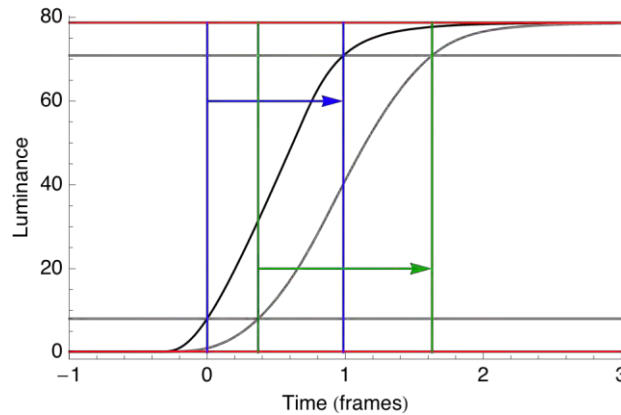


Figure 10.3-6 Measurement of step response and motion blur of an LCD.

The black line is the luminance of the LCD over time in a transition from gray level 0 (black) to 255 (white). The red lines show asymptotic black and white luminances. The gray lines show 10 and 90% of the luminance difference between on and off. The blue lines mark times at which the curve is at 10 and 90%; between them, marked by the blue arrow, is the on-time interval (0.987 frames). The gray curve is the blurred edge profile, obtained by convolution from the on-response. The green lines mark the 10 and 90% points of this curve, and the green arrow indicates the interval between them, known as the blur edge time (BET) (1.26 frames).

Current practice is to quantify motion blur in terms of the width of the edge profile, measuring from 10 to 90% of the full excursion, as shown by the green arrow in Figure 10.7-2. This width is defined as the blur edge time (BET), which in this example is 1.26 frames. BET can be converted to blur edge width (BEW) in pixels by multiplying BET by the speed in pixels/frame. So for a speed of 16 pixels/frame, $BEW = 1.26 \times 16 = 20.16$ pixels.

It is important to note that the edge profile is not always smooth and monotonic, and that the 10% and 90% points may not be well defined. An example of an edge profile between gray levels of 150 and 139 on a plasma display is shown in Figure 10.7-3. The overshoot and ringing may be visible and annoying, but are not captured by a simple time measure such as BEW. Ad hoc methods of dealing with overshoot have been proposed, but they have not been validated and do not address the full range of variations in the edge profile.

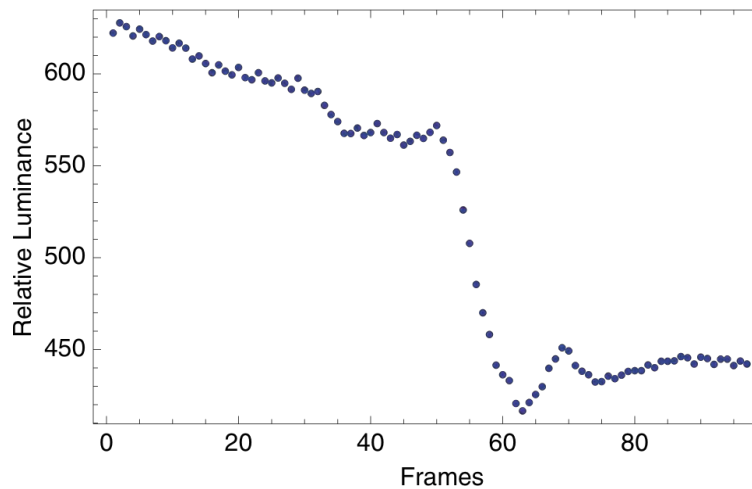


Figure 10.3-7 Edge profile between gray levels of 150 and 139 on a particular plasma display, exhibiting overshoot and ringing.

Furthermore, BEW does not take into account the contrast of the edge. When an array of different gray-level transitions is measured, each yields a BET, but each BET is for an edge of a different contrast. No method has yet been provided for converting the combination of BET and contrast into a measure of the visibility or annoyance of the artifact.

Partly for these reasons, there is at present no agreed-upon standard for meaningful measurement of motion blur. The International Committee on Display Metrology (ICDM) is addressing this gap and may provide guidance in the near future.

One approach to a perceptually meaningful metric is provided by the spatial standard observer (Watson, 2006). In that metric, the difference between an ideal edge and the actual edge, including blur, ringing, overshoot, and contrast, is quantified in units of JND. Research is under way to evaluate this approach.

10.3.2.4.4 Long-Term Behavior

The image quality of a display may be influenced by a number of long-term behaviors. The first is warm-up time, which describes the luminance change of a full-screen white after the power is turned on. Many displays may not reach a stable final value for minutes or even hours.

The second long-term property is a change (usually a decline) in full-screen white luminance over the lifetime of the display. This is sometimes called “display aging.” Some aspects of aging occur when phosphors are used as the source of illumination, which is common in CRT, LCD, and PDP. The usual measurement is number of hours of use for a 50% decline in brightness, sometimes referred to as “lifetime.” Typical values for CRT, LCD, and PDP are in the range of 20,000 to 60,000 hours, and are somewhat dependent on the brightness settings and the average gray level.

10.3.2.4.5 Temporal Metrics: Related Standards

Table 10.3-6 Temporal Metric Standards

Standard	Section	Item	Values
VESA (2001)	305-1	Response time	
VESA (2001)	305-3	Warm-up time	
VESA (2001)	305-2	Residual image	
VESA (2001)	305-4	Dominant flicker component	
VESA (2001)	305-6	Flicker visual assessment	
HFES2006	7.2.4.1	Response time	On- and off-times < 55 ms
HFES2006	7.2.4.3	Flicker	Frame rate > formula value
ISO13406	7.24	Flicker	Invisible to 90% of users
ISO13406	3.4.4, 7.21	Image formation time	On-time < 55 ms
TCO-06	A.2.8.2	Response time	On- and off-times < 13 ms

The third long-term attribute relates to uneven aging of the screen. This aging is usually called “burn-in,” or “residual image.” It may occur in CRT or PDP displays that have had long-term uneven illumination occur from persistent imagery. Usual metrics involve measurement of several small screen areas before and after long-term exposure to differential illumination VESA (2001).

10.3.2.5 Color

10.3.2.5.1 Color Primaries

The primaries of a color display are the set of elemental colors that can be generated and combined in various proportions to visually synthesize a range of colors. To synthesize a full range of colors, a display must contain at least three color primaries with a distribution of wavelengths in the red (R), green (G), and blue (B) regions of the visible spectrum. Almost all full-color displays use a set of R, G, and B color primaries, but some displays use more than three primaries to achieve specific performance objectives such as an extended range of colors or the matching of display colors to some other color medium.

Various standards exist that specify the chromaticity coordinates for the color primaries of displays used in television, computer workstations, and graphics displays and for the proper reproduction of color content from the Internet (Poynton, 2003). One prominent and important specification for display color primaries is that designated as recommendation (Rec.) 709 for high-definition television (HDTV) by the International Telecommunications Union (ITU). It also provides the basis for the standard red-green-blue (sRGB) color primary specification for

computer graphics and color Internet content. Figure 10.7-4 shows the coordinates of the ITU Rec. 709 / sRGB display color primaries plotted on a CIE 1976 UCS chromaticity diagram.

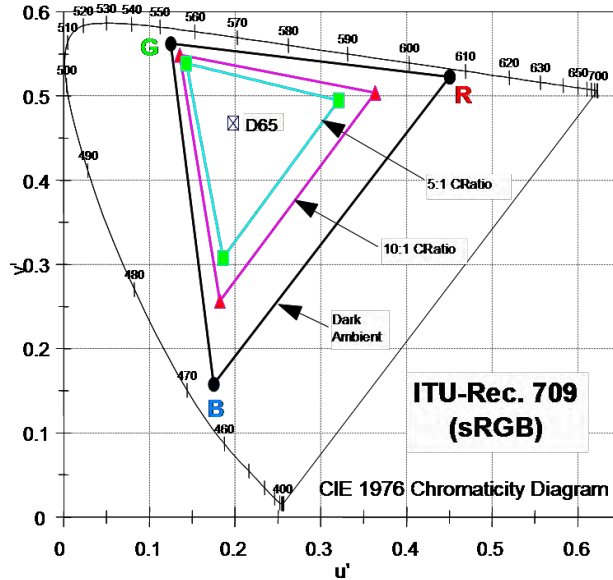


Figure 10.3-8 ITU-Rec. 709 / sRGB display color primaries plotted on a CIE 1976 UCS diagram. The Rec. 709 / sRGB color gamut is shown under three conditions of incident illumination: a dark environment and broadband illumination that reduces the display peak white contrast ratio to 10:1 or 5:1. The position of the D65 white point is also illustrated.

10.3.2.5.2 Color Gamut

The two-dimensional (2D) color gamut of a display specifies the area envelope of colors or chromaticities that can be generated on the display. It is typically described as the area bounded by display primaries in a reference chromaticity coordinate system. An example of a 2D color gamut for the Rec. 709 / sRGB set of color primaries is shown in Figure 10.7-4 and is indicated by the triangular area bounded by the chromaticity coordinates of the R, G, and B color primaries. The 2D color gamut is a useful metric for the outer limits of display color performance in that the display is capable of producing any color point either on or within the bounded area, but the restrictions arising from the limited dynamic luminance range of the primaries and the quantization of that range are absent.

A common industry metric for specifying color gamut is the area of the display gamut, in the CIE 1931 chromaticity diagram, as a percentage of the NTSC color gamut. The latter is a standard hypothetical gamut designed in the early years of television broadcasting. This metric is problematic for several reasons. First, the CIE 1931 color space is known to be far from uniform, so areas are not meaningful. It would be more sensible to compute areas in a more nearly uniform color space such as the CIE 1976 UCS discussed above. Second, when computing the ratio, it is unclear how to treat areas that are not in the intersection of the two gamuts. Third, if an arbitrary reference triangle is to be used, it would be more sensible to use one in actual use, such as the ITU Rec. 709 gamut discussed above. One solution, proposed in VESA (2001), is the gamut area metric, consisting of the ratio of the display gamut area in the CIE 1976 UCS

diagram to the entire area within the spectrum locus (0.1952). This metric has not yet gained wide acceptance.

All 2D color gamut metrics fail to represent the full range of colors that can be produced by a display, because they consist only of a slice through the 3D color volume. In particular, they neglect the dynamic range and the quantization within that range. It is possible to construct 3D color gamut metrics that would give a more accurate representation of a display's rendering capabilities. For example, the gamut may also be represented as a 3D volume in which the third dimension is luminance. More typically, the gamut may be a perceptually linearized rescaling of luminance into a normalized lightness dimension using the CIE $L^*a^*b^*$ color space, as illustrated in 510.7-1 for a display with ITU Rec. 709 / sRGB color primaries and a quantized luminance range for each color primary.

New, more general gamut metrics are especially needed as new, extended color gamuts, and extended dynamic ranges, are enabled by new technology. Examples are the xvYCC extended color gamut for video systems (Tatsuhiko, et al., 2006), and so-called "deep color," a scheme for 30- to 48-bit color representation that is now part of the High-Definition Multimedia Interface (HDMI). The design of accurate and meaningful 3D color gamut metrics is an important topic for future research.

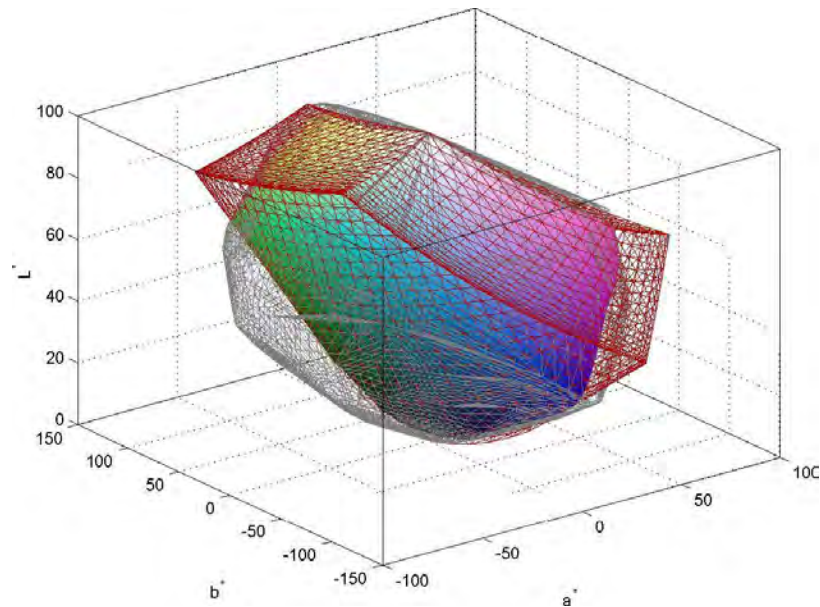


Figure 10.3-9 Three-dimensional color gamut for the ITU-Rec. 709 / sRGB color primaries plotted in the CIE $L^*a^*b^*$ color space. The Rec. 709 / sRGB color gamut is represented by the red wireframe. The gray volume is an estimate of the gamut of real-world object colors, and the full-color volume illustrates the intersection of these two gamuts.

10.3.2.5.3 White Point

The white point of a display establishes the effective colorimetric center of balance for a color display system and the estimated source of chromatic visual adaptation for the display observer.

The white point establishes the luminance ratios between the color primaries to achieve a specified chromaticity in the achromatic region of the display color gamut.

The white point is typically specified as a colorimetric match to a color temperature defined in terms of degrees Kelvin (K) along the blackbody radiation curve. Such a colorimetric match is designated as a correlated color temperature (CCT). The process of establishing the display white point involves locating the chromaticity coordinates of a specified CCT and then determining the ratios of the display color primaries that are necessary to achieve these coordinates. White points in common usage along with their CIE standard illuminant designation (if defined) and CIE 1976 chromaticity coordinates include CCTs of 6,504° K (CIE Source D65; $u'=.1978$, $v'=.4683$); 5,000° K (CIE Source D50; $u'=.2092$, $v'=.4881$); 6,774° K (CIE Source C; $u'=.2009$, $v'=.4609$); 2,856° K (CIE Source A; $u'=.2560$, $v'=.5243$); and 9,300° K ($u'=.1915$, $v'=.4436$). Figure 10.7-5 shows the locations of the D65 CCT in a CIE 1976 chromaticity diagram.

10.3.2.5.4 Ambient Color Gamut

Ambient illumination incident on a display typically reduces the contrast and color saturation of displayed content and may also change the hue of displayed content if the illumination departs substantially from an achromatic or neutral spectrum. The degree to which incident ambient illumination changes the display color gamut depends on the emissive (if any) and reflective characteristics of the display, the lux and SPD of the incident illumination, and the geometric relations between the display and the source(s) of illumination.

It is important to consider the color gamut of displays under the range of ambient illumination levels anticipated in a particular operational environment. Such considerations may affect the choice of display technologies and the specifications for display visual parameters. Figure 10.7-6 provides examples of how the color gamut for a display with sRGB color primaries changes from a nominal or dark ambient environment to one in which a high level of broadband illumination is incident on the display surface. The incident illumination reduces both the display contrast ratio and color saturation, reducing the effective color gamut of the display.

10.3.2.5.5 Color Tracking

Once the white point of the display is selected and the resulting luminance and drive level ratios are established for that white point, it is important to ensure that these ratios are maintained within reasonable tolerances across all display intensity levels. Drive level can be thought of as the product of the contrast setting and the gain setting for a color. The degree to which the luminance and drive level ratios are maintained determines the stability of mixture colors over the dynamic range of the display and is known as color tracking.

Various metrics can be used to assess color tracking. One obvious method is to evaluate the display primary luminance ratios for the white point across drive levels, while another method involves measurement of white point chromaticity across the same range. Color difference metrics are also useful for this purpose and provide a general approach for establishing color display tolerances.

10.3.2.5.6 Related Standards

Table 10.3-7 Color Standards

Display Standard	Section	Topic
Human Factors and Ergonomics Society (2007)	7.2.5.6 7.2.5.7 7.2.5.8 7.2.5.9 7.2.5.10 7.2.6.2	Default Color Set Color Differences Color Uniformity Number of Colors Background/Foreground Interactions Size of Colored Characters
ISO, 2001	7.5 7.25 7.26 7.27 7.28 7.29	Chromaticity Uniformity Difference Default Color Set Multicolor Object Size Color Differences Spectrally Extreme Colors Number of Colors
ISO/WD 18789-3	6.4.2 6.6.4 6.7.1 6.7.3 6.7.4 6.7.5 6.8.1 6.8.2	Color Nonuniformity Color Coding Monochrome and Multicolor Object Size Color Considerations for Graphics Background and Surrounding Image Effect Number of Colors Color Gamut and Reference White Color Gamma and Grayscale
TCO'03 VDU of CRT Type	A.2.6.1 / B.2.6.1 A.2.6.2 / B.2.6.2 A.2.6.3 / B.2.6.3	Correlated Color Temperature Variation Color Uniformity RGB Settings
TCO'03 FPD	A.2.6.1 / B.2.6.1 A.2.6.2 / B.2.6.2 A.2.6.3 / B.2.6.3 A.2.6.4 / B.2.6.4 A.2.6.5 / B.2.6.5	Correlated Color Temperature Variation Color Uniformity RGB Settings Color Uniformity – Angular Dependence Color Greyscale Linearity
MIL-STD-1472F	5.2.1.5.6 5.2.1.5.6.1 5.2.1.5.6.2 5.2.1.5.6.3 5.2.1.5.6.4	Color Coding Use of Color Coding Color Selection Dark Adaptation Color Contrast

Display Standard	Section	Topic
	5.2.1.5.6.5 5.2.1.5.6.6	Color Difference Color Object Size
MIL-HDBK-87213	3.2.1.6.5 4.2.1.6.5 3.2.1.8 4.2.1.8	Chromaticity Difference Verification of Chromaticity Difference Display Color Verification of Display Color
VESA (2001)	302-1 302-2 302-4 302-4A 302-6 302-6A 302-7 304-5 304-6 306-1 306-4 307-6	Luminance and Color of Full-Screen White Luminance and Color of Full-Screen Black Gamut and Colors of Full Screen Gamut-Area Metric Color Scales of Full Screen White-Point Accuracy Full-Screen Grayscale Color Changes Color Gamut of Centered Box Color Scales of Centered Box Sampled Uniformity and Color of White Sampled Uniformity of Colors Color-Inversion Viewing Cone

10.3.2.6 Viewing Angle Performance

Viewing angle is the angle between a normal at the center of the display surface and a line from the same point to the eye (or measurement device, or nasal bridge). Figure 10.7-6 illustrates the general concept of display viewing angle. Displays may exhibit changes in various aspects of their performance as a function of viewing angle. Common changes in display visual characteristics with viewing angle include luminance attenuation, degradation of contrast or even contrast inversion, and color changes including shifts in the hue and reductions in the saturation of displayed colors. Moreover, such changes are often anisotropic and vary with both the azimuthal viewing direction (ϕ) and the polar declination angle (θ) with respect to the display normal.

Standards for viewing angles are given in Table 10.7-7.

Display technologies differ in the degree to which their performance varies with viewing angle. CRTs, which are basically Lambertian emitters, typically exhibit few or no changes with viewing angle. PDPs generally show some attenuation in luminance with eccentricity. The viewing angle performance of rear-projection displays is primarily determined by characteristics of the projection screen, and by design such screens often exhibit anisotropic luminance changes due to

screen geometry and optical gain. The largest performance variations attributable to viewing angle are typically found in LCDs, some of which can exhibit dramatic and highly anisotropic changes in luminance, contrast, and color. Although the optics of LCDs make some variation in viewing angle inevitable, several recent advances in LCD technology have ameliorated the dramatic viewing-angle problems that plagued earlier twisted-nematic-type LCD panels.

Viewing angle performance usually refers to changes in luminance, contrast, or chromaticity of a pixel or patch of pixels as a function of viewing angle. A complete description of performance would be provided by a function of the form $Y_{xy}(r, g, b, \theta, \phi)$ where Y_{xy} is a CIE coordinate; r , g , and b are the digital values of the selected color; θ is the polar declination angle, and ϕ is the azimuthal angle in spherical coordinates. Since a high-resolution sampling of Y_{xy} for the hemisphere of all possible viewing angles would require a prohibitive number of measurements, various simplifications are adopted. For example, many measurements consider only luminance performance (Y) as a function of gray level ($r=g=b$), and often consider only the contrast ratio between white and black. Likewise it is common to consider only a few angles in each of the horizontal and vertical directions or to sample a set of angles in spherical coordinates (e.g., 10° increments in θ and ϕ) and then fit iso-contour lines to estimate performance for the full viewing volume. Figure 10.7-3 shows a peak contrast ratio iso-contour plot of an active-matrix LCD.

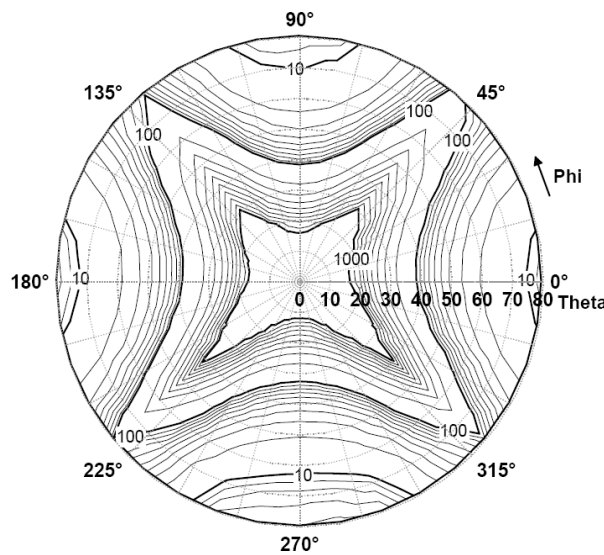


Figure 10.3-10 Peak photopic contrast ratio iso-contours for an active-matrix LCD plotted in spherical coordinates.

One common practice is to verify that a display meets a set of standards (e.g., for luminance, contrast, and color) within an envelope specified by four selected angles: left, right, up, and down. For example, Human Factors and Ergonomics Society (2007) states that all of its requirements should be met within $\pm 30^\circ$ horizontally, and $+30^\circ$ and -20° vertically. Another common practice is to specify a set of four angles (left, right, up, down) at which performance (such as the contrast ratio or color) changes by a threshold amount (e.g., contrast ratio reduced by 0.5, or color shift of CIE $L^*a^*b^*$ $\Delta E = 5$) from its on-axis or normal value. VESA (2001) provides a good description of various measurements of viewing angle performance. Actual

required viewing angle performance will depend on the application and its distribution of viewing angles.

10.3.2.6.1 Viewing Angle: Related Standards

Table 10.3-8 Viewing Angle Standards

Standard	Section	Topic
Human Factors and Ergonomics Society (2007)	7.2.2.3	Design Viewing Envelope
ISO, 2001	7.2	Design Viewing Direction
ISO/WD 18789-3	6.1.2	Design Viewing Direction
TCO'03 FPD	A.2.3.4 / B.2.3.4 A.2.4.2 / B.2.4.2 A.2.6.4 / B.2.6.4	Luminance Uniformity Angular Dependence Luminance Contrast Angular Dependence Color Uniformity – Angular Dependence
MIL-HDBK-87213	3.2.1.6.7 4.2.1.6.7	Viewing Angle Verification of Viewing Angle
VESA (2001)	300-2 307 307-1 307-2 307-3 307-4 307-5 307-6 304-6 306-1 306-4 307-6	Coordinates and Viewing Angles Viewing Angle Performance Four-Point Viewing Angle Threshold-Based H&V Viewing Angles Gray-Scale Inversion Viewing Cone Thresholds Gray-Scale Inversion Viewing Cone Color Inversion Viewing Cone Color Scales of Centered Box Sampled Uniformity and Color of White Sampled Uniformity of Colors Color-Inversion Viewing Cone

10.3.2.7 Text

Early display standards documents contained a wealth of detail regarding particular display content elements. With the ubiquity of programmable matrix displays, on which arbitrary display contents may be rendered, it seems more appropriate to write standards that mandate more general properties, such as resolution, contrast, gray levels, and color gamut. Nevertheless, a few types of display content are sufficiently distinct and frequent that they deserve special mention. Text is the most obvious of these special display elements.

10.3.2.7.1 Background Research

Standards for display text are concerned primarily with character size, spacing, aspect ratio, and line spacing. Here a brief survey of relevant research results is provided.

Characters are complex graphic elements (especially if Asian fonts are considered), and the characters of a single font vary in width and height. Nevertheless there is a need to specify a size for each font. In the standards that are considered in this chapter, this size is usually given by the height of the uppercase letter H (sometimes known as the “cap-height”). In contrast, typographers typically specify font size in terms of the height of the letter x (also known as “x-height,” or the unit “ex”). The ratio of x-height to cap-height can be considerably different for different fonts. Because lowercase characters are more common in reading experience, it may be argued that x-height may be the better basis for standardization. A further reason for this choice is that most of the research on reading has varied x-height, rather than cap-height.

To illustrate this discussion, a magnified example of a particular fixed-width 32-point Courier font is shown in Figure 10.7-4. In this example, the x-width is 1.16 times the x-height, and the H-height is 1.28 times the x-height. The default horizontal spacing between the two xs is 1.31 x-heights.

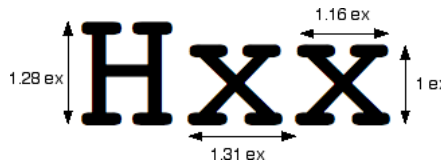


Figure 10.3-11 Example of font dimensions.

A useful starting point for the discussion of character size is the observation that subjects with normal visual acuity (20/20) cannot identify letters with a height less than 5 minutes of arc. However, this limit is reached by emmetropic observers (observing normally with the object in sharp focus on the retina) under conditions where each letter is scrutinized, and where the letters are drawn from a special character set (the Sloan letters). To accommodate less-than-normal acuity and a variety of fonts, and to allow rapid reading without scrutiny, larger character heights are usually required.

In a comprehensive series of articles, Legge and colleagues studied reading rate as a function of letter size, contrast, font, color, and other variables. Legge varied character width (which he defined as the horizontal pitch between adjacent letters), and actual letter size covaried with this spacing (Figure 10.3-12). A fixed-width font was used. As noted above, character pitch is often about the same as letter height. The best reading rates were obtained for character widths between 24 min and 42 min, and reasonable rates were obtained for widths between 12 min and 360 min. Rates declined rapidly for letters smaller than 12 min and for very large letters (Legge, Pelli, Rubin, & Schleske, 1985). These basic results are shown in Figure 10.3-13.

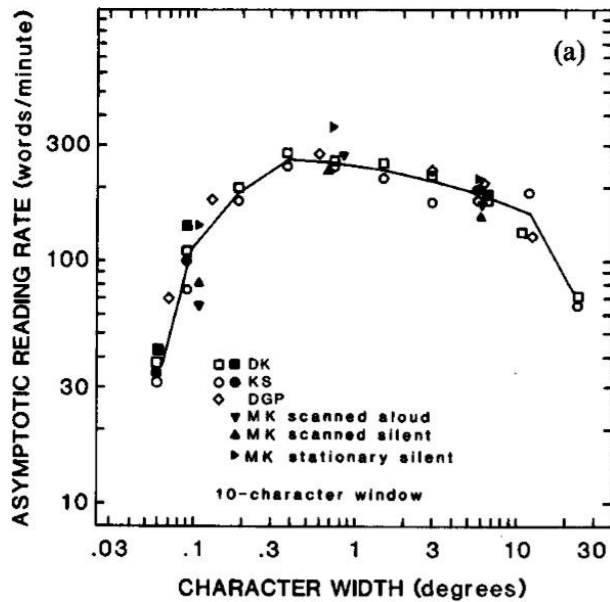


Figure 10.3-12 Effect of character width and spacing on reading rate. Figure is reproduced from (Legge, 1985). DK, KS, DGP and MK are the initials for individual observers.

Using more advanced display technology, Chung also measured reading rate as a function of character spacing (S. T. Chung, Mansfield, & Legge, 1998). Her data, which covers only smaller sizes, are shown in Figure 10.3-13. They are similar to the data of Legge, though Chung's data does not extend to the optimal size in Legge's data. The blue curve is an average for six observers, obtained by averaging a linear interpolation of the data for each observer over the indicated range of spacings. The red points are averages extracted from Legge's data.

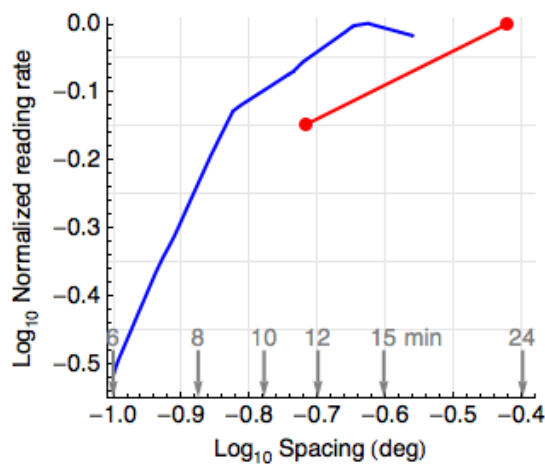


Figure 10.3-13 Reading rate as a function of letter size or spacing. (S. T. Chung, et al., 1998).

Legge et al. also found that text polarity (black-on-white vs. white-on-black) had no effect. When letter images are sampled (as on a matrix display), reading rate declines below a critical sample density that is a function of letter size, and is about 4 samples/width for 6-min characters. For the best sizes, contrast has little effect until it is reduced to 0.1 or below (Legge, Rubin, & Luebker, 1987). For smaller and larger sizes, contrast has a greater effect. The reading contrast threshold (contrast at which reading rate is 35 words per minute) can be understood in terms of the contrast sensitivity function and a critical frequency of 2 cycles per letter width.

Color and luminance contrast have equal effects on reading rate when both are expressed in units of threshold. When both are present, the larger controls reading rate (Legge, Parish, Luebker, & Wurm, 1990).

Chung examined the separate effects of letter size and spacing using a fixed-width Courier font. She first located the critical print size, the size at which reading rate reaches its asymptotic value. Using letters of either 0.8 or 1.5 times the critical print size, she found only modest variations in reading rate, as shown in Figure 10.3-14.

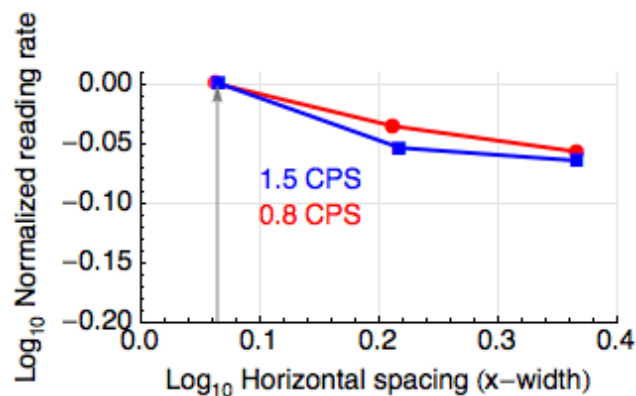


Figure 10.3-14 Reading rate as a function of horizontal spacing. (S. T. L. Chung, 2002).

Spacings that caused letters to overlap were excluded. The gray arrow indicates the default spacing for this font of 1.16 x-width.

In a subsequent study on vertical spacing, Chung found equally small effects, as shown in Figure 10.3-15. A summary of Chung's results might be that as long as characters do not overlap, letter spacing has little effect on reading rate.

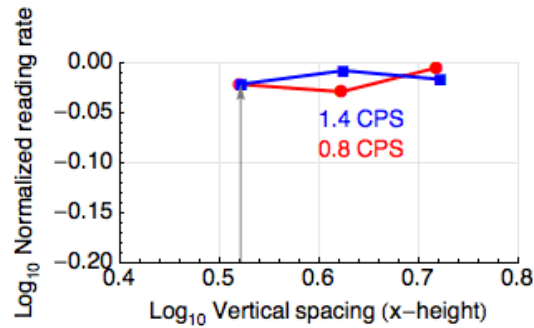


Figure 10.3-15 Reading rate as a function of vertical spacing. Data from (S. T. Chung, 2004).

Spacings that cause letters to overlap were excluded. The gray arrow indicates the default spacing for this font of 2.6 x-height.

Pelli and colleagues have pointed out that letter spacing and letter size are usually confounded. They argue that the limitation is actually letter spacing, due to the effects of “crowding” on adjacent letters, especially as the letters viewed in a fixation extend into the periphery (Pelli, et al., 2007).

The studies cited above used fixed-width fonts. Arditi and colleagues compared fixed- and variable-width fonts, and their results show no consistent difference in reading rate for the two types of font over the range of sizes of interest here (15 to 30 min) (Arditi, Knoblauch, & Grunwald, 1990).

As noted below under Research Needs, text displays might be better designed with tools that could compute legibility for arbitrary combinations of size, shape, contrast, and color. But until such tools are available, we provide a brief survey of existing metrics and standards in this area.

10.3.2.7.2 Character Size (Degrees)

In Figure 10.3-16, a summary of various standards is provided, in which both reading and scrutiny are shown. For scrutiny, letters must be identifiable, but more time and effort may be taken. Examples are subscripts and superscripts.

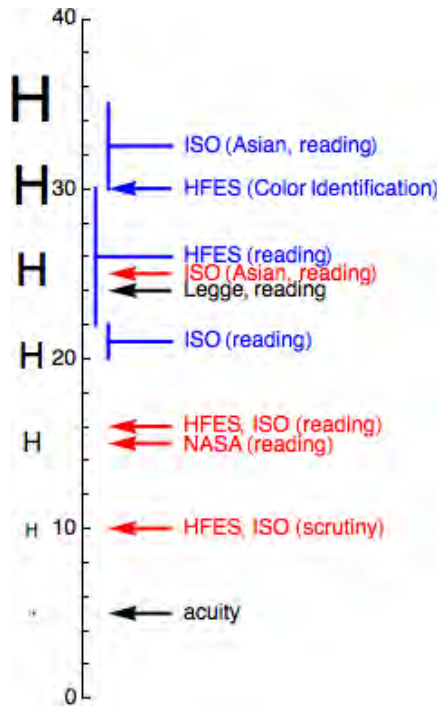


Figure 10.3-16 Character height standards in minutes of arc. Requirements are indicated in red, recommendations in blue. The letter size corresponding to normal visual acuity is also shown, as well as the optimal size found by Legge (see Figure 10.3-13). The illustrative letters on the left are correct when viewed from an appropriate distance.

10.3.2.7.3 Character Size (Pixels)

Character size in pixels (sometimes called character format or character matrix) is an issue only for displays with low visual resolution (< 30 pixels per degree). Under those circumstances, characters meeting requirements for size in degrees (Figure 10.3-13) might contain too few pixels for intelligible rendering. Common requirements are shown in Table 10.3-9. As displays trend toward finer pixel pitch and higher visual resolution, these requirements become less relevant.

Table 10.3-9 Character Size Requirements in Pixels

Width	Height	Application	Standard
5	7	uppercase, numerals	Human Factors and Ergonomics Society, 2007, ISO
4	5	Subscripts	Human Factors and Ergonomics Society, 2007, ISO
	+2	Lowercase	Human Factors and Ergonomics Society, 2007, ISO
	+2	Diacrits	Human Factors and Ergonomics Society, 2007, ISO
7	9	Reading	ISO
15	16	Asian, reading	ISO
24	24	Asian, reading, preferred	ISO

10.3.2.7.4 Character Size (Points)

The point is a traditional typographic unit of font size. In modern usage, a point is 1/72 of an inch. The point size of a particular font is defined as the distance from the tallest ascender to the lowest descender, plus built-in leading (spacing) above and below each character. Thus successive lines of 72-point type will be one inch apart from center to center.

- Unless the viewing distance is known with some certainty (e.g., handheld displays), character sizes should be specified in degrees of visual angle, rather than in point size.

If viewing distance is known, point size can be related to x-height in degrees. But this relationship is only approximate, because different fonts may occupy different portions of the total line height; there is no fixed relationship between point size and x-height or cap-height.

10.3.2.7.5 Stroke Width

In many fonts, stroke width is not well defined. Nevertheless it is clear that excessively thin or thick strokes may reduce the legibility of text.

- Example requirements are that stroke width be from 1/12 to 1/6 (HFES, 2007) or 1/12.5 to 1/5 (ISO, 2001) or 1/8 to 1/6 (NASA-STD-3000) of character height.

10.3.2.7.6 Character Spacing

- The following are the existing standards for spacing between characters: one pixel or 0.2 character width (NASA-STD-3000), stroke width (HFES, 2007, sans serif), stroke width or one pixel (ISO, 2001, sans serif), one pixel (HFES, 2007, ISO 2001, serif). HFES recommends 0.25 to 0.6 of a character width.

10.3.2.7.7 Line Spacing

- Vertical spacing between lines, including ascenders, descenders, and diacrits, is required to be one pixel (HFES 2007, NASA-STD-3000, ISO 2001). HFES recommends 0.15 of the letter height.

10.3.2.7.8 Word Spacing

- Word spacing is required to be one letter width (NASA-STD-3000), greater than the letter spacing and at least 0.5 letter width (HFES, 2007), or one letter width or one space proportional font (ISO, 2001).

10.3.2.7.9 Character Contrast

- TCO'03 and TCO'06 mandate that character contrast be greater than 0.7.

10.3.2.7.10 Related Standards

Table 10.3-10 Text Standards

Standard	Section	Topic
VESA (2001)	303-5	Intracharacter luminance and contrast
Human Factors and Ergonomics Society (2007)	7.2.6.1	Character Height
Human Factors and Ergonomics Society (2007)	7.2.6.2	Sizes of Colored Characters
Human Factors and Ergonomics Society (2007)	7.2.6.3	Character Width-to-Height Ratio
Human Factors and Ergonomics Society (2007)	7.2.6.4	Stroke Width
Human Factors and Ergonomics Society (2007)	7.2.6.5	Character Format
Human Factors and Ergonomics Society (2007)	7.2.6.6	Spacing Between Characters
Human Factors and Ergonomics Society (2007)	7.2.6.7	Spacing Between Lines
Human Factors and Ergonomics Society (2007)	7.2.6.8	Spacing Between Words
ISO, 2001	7.10	Character format
ISO, 2001	7.11	Between-character spacing

Standard	Section	Topic
ISO, 2001	7.12	Between-word spacing
ISO, 2001	7.13	Between-line spacing
ISO, 2001	8.5	Combined measurement for character design analysis
ISO 9241	5.8	Character format
ISO 9241	5.9	Character size uniformity
ISO 9241	5.10	Between-character spacing
ISO 9241	5.11	Between-word spacing
ISO 9241	5.12	Between-line spacing
MIL-1472	5.5.5	Design of label characters
TCO'06	A.2.4.1	Luminance contrast – characters
TCO'03	A.2.4.1	Luminance contrast – characters

10.3.2.8 Research Needs

10.3.2.8.1 Uniformity

Uniformity metrics are at present very ad hoc. The measurements and the permissible values are not consistently measured or justified. The problem is exacerbated by the failure of the metrics to accommodate very large variations in display size, which will profoundly affect the visibility of nonuniformities. This is another case, like mura, in which human-factored, model-based metrics need to be researched, designed, and validated.

10.3.2.8.2 Mura

Mura (display blemishes) is a key concern of manufacturers and buyers of modern flat-panel displays, yet there is no agreed-upon metric to quantify this artifact. This is partly because it is a visual artifact: only visible blemishes matter. Model-based metrics for mura have been proposed, but they require further development.

10.3.2.8.3 Motion Blur

Motion blur is a key challenge for current displays. Many technologies are under development to ameliorate this problem while preserving brightness, spatial resolution, and other key attributes. An accurate, validated human factors metric for motion blur would be of great value in evaluating these technologies.

10.3.2.8.4 3D Color-Gamut Metrics

As noted previously, 2D color-gamut metrics fail to account for the effect of dynamic range and quantization. Uniform color spaces, such as CIE $L^*a^*b^*$ and its successors, provide a path for the development of 3D color-gamut metrics. Such metrics might count the number of discriminable colors offered by a display system, including quantization and variations in luminance in the calculation. However, research is required to design such measures and to verify that they relate to display quality.

10.3.2.8.5 Text

The lengthy list of *ad hoc* rules related to character dimensions is troublesome, but not surprising. Even within a single font, characters differ markedly in size and shape; allowing the font to vary increases this variability. Current high-resolution matrix displays allow great variety and creativity in the design of fonts, but this, too, increases the variation in size and shape. The inclusion of Asian and other language character sets increases it further. Beyond variations in size and shape, character sets differ in their number of elements, which, in turn, affects the information conveyed by each character and the difficulty of identification. Because current displays allow the color of text and background to be easily controlled, color and contrast also will affect legibility. For all of these reasons, it is unlikely that a small set of well-defined rules will serve in all of these (and future) situations.

A better solution would be a tool that measures the discriminability of the elements of an arbitrary symbol set. A metric of this sort has recently been developed, and has been shown to provide good predictions of letter identification in the presence of various optical aberrations (Watson & Ahumada, 2005b; Watson & Ahumada, 2007). This metric would have the advantage of taking into account all of the variations mentioned above. Additional research is required to determine its value in setting standards for character size and format in displays. Progress has also been made in understanding how complexity of letter shape affects identification, and this also could lead to useful metrics (Pelli, Burns, Farell, & Moore-Page, 2006)

10.3.2.8.6 Legibility and Symbol Discriminability

Legibility is a key concern in the design of visual displays and interfaces. However, the metrics provided to evaluate legibility have not kept pace with the proliferation of display types, and with tools that enable variations in font shape, size, color, contrast, background, and arrangement. This great diversity in possible manifestations of text means that no simple mandates, such as point size, will suffice. Instead, model-based metrics and/or performance-based metrics will be required. Research is needed to design and validate these metrics. Very similar metrics may be useful to predict the discriminability of arbitrary symbol sets, such as icons or other user-interface elements. These predictions can, in turn, be used to optimize symbol design.

10.3.2.8.7 Clutter

- Though somewhat outside the range of metrics considered in this chapter, clutter is an important consideration in the design of visual display content. Clutter arises from the competing desires to provide simple information layouts and to provide as much information as possible. There is some prospect that current models of vision might provide useful metrics of clutter (Bravo & Farid, 2008; Rosenholtz, Li, & Nakano, 2007).

10.3.2.8.8 Global Display Quality Metrics

Tradeoffs in display design place different metrics in competition. For example, motion blur can be reduced by shortening the hold time, but at a cost in brightness. Reflections can be reduced by surface coatings, but these may reduce contrast as well. Yet, beyond ensuring that all minimum

requirements have been met, no sensible method of trading off one metric against another is currently available. To do so, metrics that combine other metrics are needed. These global quality metrics are most likely to arise in the context of model-based metrics, as described above, because models provide a linkage, such as JNDs or bits of information, through which different metrics can be combined.

10.3.2.8.9 Human Factors Metrics

Many display metrics have been constructed as purely physical measurements of display attributes. But as human factors metrics, they need to be more closely connected to human perception and task performance.

10.3.2.8.10 Model-based Metrics

Because they are inherently in mathematical form, and because they are more general than the point solutions often provided by metrics based on small sets of measurements, model-based metrics should be a goal for all human factors standards. This is an especially realistic goal for display standards, because models of human visual perception are in an advanced state of development. Additional research is needed, however, to apply those models to critical display metrics, and to validate their performance.

10.3.3 Display Technologies

10.3.3.1 Overview of Display Technologies

A broad range of display technologies are now available and under development to serve specific requirements and applications.

Figure 10.3-17 illustrates the range of currently available display technologies. Regardless of the technology used, the common emphasis in virtually all application areas is on improved display image quality and lower display cost. Desired image quality improvements for all displays are enhancements in contrast, brightness, color gamut, and resolution.

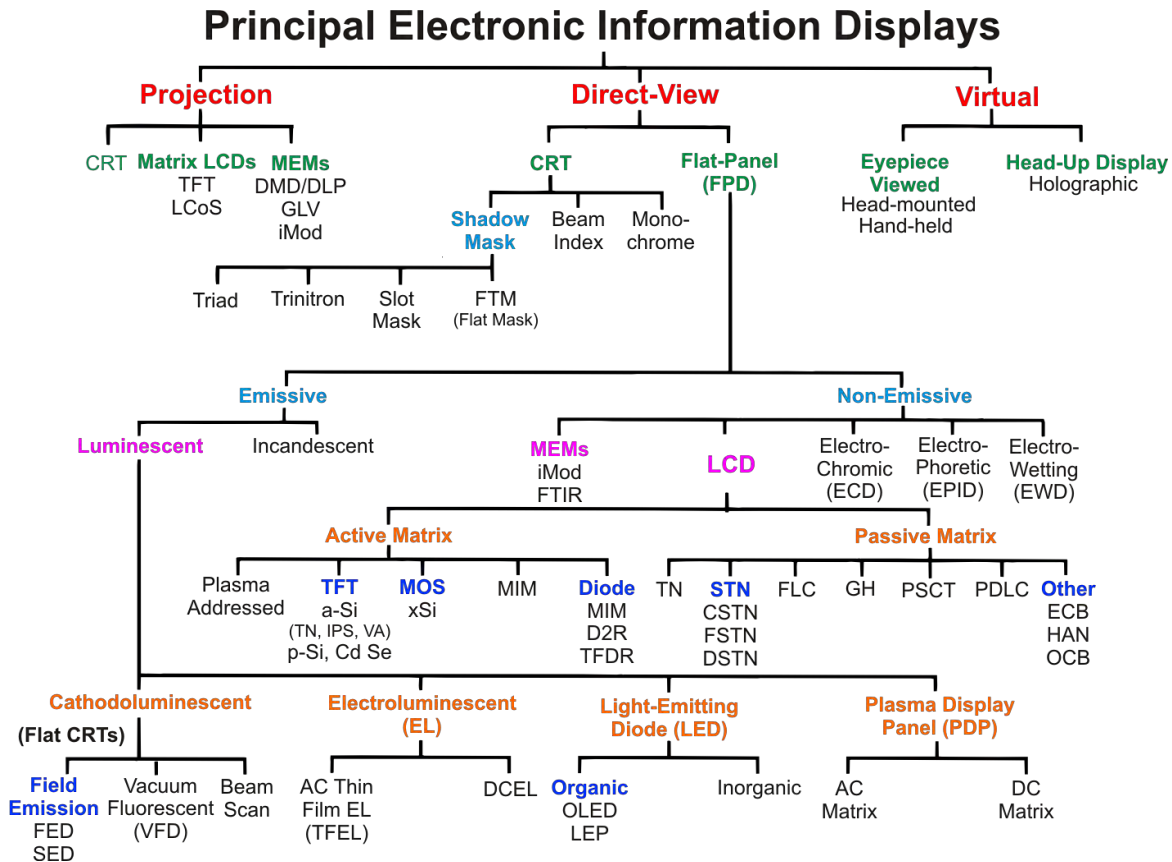


Figure 10.3-17 Range of currently available display technologies.

Hierarchical organization of currently available display technologies, arranged according to viewing mode (projection, direct-view, and virtual) and whether the technology intrinsically generates light (emissive) or modulates light from a separate external or internal source (non-emissive).

Display applications in the industrial, military, and aerospace sectors often have their own unique requirements and performance standards. However, it is now commonplace that these applications adopt the core display technologies developed through huge investments in commercial research and development for their specialized needs.

The following sections provide an overview of the most important display technologies currently available. The technology review is divided into the following major sections: direct-view displays of the emissive type, direct-view displays of the non-emissive type, and projection display technologies. Each of these sections contains two categories of display technology: those that are beyond the development stage and currently available on the market as a mature technology, and those that are in active stages of development with limited market penetration and/or are limited in scope to niche applications. For the former category the basic principles of operation, most salient operating characteristics, and major operational advantages and disadvantages are briefly reviewed. For the latter category only a limited operational description

and status estimate are provided. The final section contains an overview of emerging and future display technologies.

Following the technology descriptions, other sections list and describe standards for display technologies (10.5.5) and areas for future research (10.5.6).

10.3.3.2 Direct-View Displays of the Emissive Type

Emissive displays are those that intrinsically generate or emit light. For emissive displays the light-generating and image-forming functions are provided by the same elements.

10.3.3.2.1 Cathode Ray Tubes

The CRT has dominated the display market since the 1960s, until the recent proliferation of flat-panel display technologies. The principal technology for full-color, direct-view CRTs is the shadow-mask CRT. Table 10.3-11 shows cathode ray tube attributes and their ratings for use as a display device.

Table 10.3-11 CRT Technology Attribute Ratings and Comments

Display Technology Attributes	General Rating	Comments
Spatial Addressability Spatial Resolution	Very High High	Gaussian beam reduces spatial noise but limits optical resolution Luminance and resolution negatively correlated
Temporal Response	High	Short and medium-short persistence phosphors exhibit narrow impulse response
Luminance	Low to Medium	Monochrome CRTs capable of moderate to high luminance Shadow-mask and phosphor fill factor limit luminance of color CRTs
Contrast Ambient Contrast	High Low to Medium	Excellent black levels Diffuse reflectance from phosphor limits ambient contrast
Grayscale Performance	Very High	Continuous analog grayscale capability Transfer function a true power function
Viewing Angle	Very High	Effectively Lambertian viewing Contrast enhancement filters can attenuate luminance off axis
Color Gamut Ambient Color Gamut	High Low to Medium	Color gamut defined by phosphor SPD Diffuse reflection from phosphors reduces color gamut under ambient lighting
Physical Package	Low	Large, bulky, and heavy Substantial depth required
Application Flexibility	Low	Not amenable to portable or battery-powered applications Limited to middle range of screen sizes
Other		Subject to various geometric distortions such as barrel, pincushion, and trapezoidal Subject to flicker due to impulse response – requires high refresh rates

10.3.3.2.2 Plasma Display Panels

The PDP is a flat panel display capable of high brightness, color, and large display sizes. The basic principle of operation is that intersecting row and column electrodes excite a gas, which in turn excites a phosphor, which releases light. Color is produced by the use of localized deposits of three different phosphors.

The use of powder-type phosphors in color PDPs introduces diffuse scattering much like that found in CRTs, which increases the reflectance of the front surface and thereby reduces the ambient contrast of the device. Color filters can ameliorate this effect but at a cost in brightness.

PDPs do not have analog grayscale capability and thus use pulse-width modulation (PWM) to generate intermediate gray levels. This, and the need to impose a gamma function, make the PDP subject to contouring artifacts at low gray levels and to perceptible motion artifacts when observers visually track or pursue the motion of objects in dynamic images (Schindler, 2004).

Table 10.3-12 shows PDP technology attributes and their ratings for use as a display device.

Table 10.3-12 PDP Technology Attribute Ratings and Comments

Display Technology Attributes	General Rating	Comments
Spatial Addressability Spatial Resolution	High High	Spatial resolution limited by relatively low pixel density
Temporal Response	Medium	Phosphors exhibit narrow impulse response Temporal aperture extended by sample-and-hold mode of operation
Luminance	Medium to High	PWM and large number of subframes for grayscale reduce luminance potential
Contrast Ambient Contrast	High Low to Medium	Excellent black levels Diffuse reflectance from phosphor limits ambient contrast
Grayscale Performance	Medium	PWM, linear transfer function and temporal subframe structure result in non-optimal grayscale performance
Viewing Angle	Very High	Effectively Lambertian viewing Contrast enhancement filters can attenuate luminance off axis
Color Gamut Ambient Color Gamut	High Low to Medium	Color gamut defined by phosphor SPD Diffuse reflection from phosphors reduces color gamut under ambient lighting
Physical Package	Medium	Large and relatively heavy Relatively small depth required
Application Flexibility	Low	Not amenable to portable or battery-powered applications Limited to large screen sizes
Other		Subject to contouring artifacts at low gray levels Subject to perceptible motion artifacts when viewing dynamic imagery

10.3.3.2.3 Light-Emitting Diodes and Organic Light-Emitting Diodes

The LED is a semiconductor device consisting of a single p-n junction; light is emitted when the junction is forward-biased by the application of a suitable voltage. The first commercially

available LEDs were introduced into the marketplace in 1968 and quickly became an important technology for indicator lamps and small segmented alphanumeric displays.

LEDs are now capable of producing a full spectrum of colors with very high color saturation and good luminous efficiency. Nevertheless, relatively high cost, interconnect complexity, and manufacturing limitations in building high-density arrays of full-color LEDs have restricted their use primarily to very large displays for digital signage and electronic billboard applications. Organic light-emitting diodes (OLEDs) and polymer LEDs (PLEDs) are LEDs whose emissive electroluminescent layer consists of a film of organic compounds (Bulovic, 2005; King, 1994). These films emit light when subjected to an electric current. The SPD of the emitted light depends on the type of organic molecule in the emissive layer. Full-color OLEDs are generally achieved by either spatial patterning of R, G, and B emissive materials or by use of a broadband emissive material in conjunction with a spatial pattern of R, G, and B color-selection filters. The intensity of the emitted light depends on the amount of electrical current applied. The nonlinear relationship between voltage and current provides OLEDs with a nonlinear transfer function that is well characterized by a power function.

Claimed advantages for OLEDs include simplified manufacturing structure, compatibility with flexible substrates, lower manufacturing costs than LCDs or PDPs, high contrast with true black level, high luminance with good luminous efficiency, low power consumption, fast temporal response, wide viewing angle, and excellent grayscale performance (Bulovic, 2005; Ghosh & Hack, 2004). The principal disadvantages include limited lifetime of OLED and PLED emissive materials, lack of a stable short-wavelength emissive material with a good lifetime, differential aging of emissive materials with different SPDs, and susceptibility to contamination and damage from moisture. In addition, reflections from metal cathodes and other metallic structures in these devices can result in high levels of internal specular reflection under ambient illumination, with commensurate degradations of ambient contrast. Circular polarizers may be used to mitigate these reflections, but their use dramatically reduces the luminous efficiency of the display. OLED and PLED display technologies remain in a very active state of development with a great deal of ongoing research on OLED / PLED materials, display system architectures, and manufacturing processes. To date only a few small, mobile display products using OLEDs and PLEDs have appeared and stayed on the market.

Table 10.3-13 shows OLED/PLED technology attributes and their ratings for use as a display device.

Table 10.3-13 OLED / PLED Technology Attribute Ratings and Comments

Display Technology Attributes	General Rating	Comments
Spatial Addressability Spatial Resolution	High High	Spatial resolution can be enhanced by vertically stacked color pixel structure
Temporal Response	Medium to High	Native response in sub-millisecond range Temporal aperture extended by sample-and-hold mode of operation in active-matrix configurations
Luminance	Medium to High	Material-dependent Use of circular polarizer to enhance ambient contrast reduces luminance
Contrast Ambient Contrast	High Low to Medium	Excellent black levels Specular reflectance from metal cathode limits ambient contrast Circular polarizer can be used to enhance ambient contrast
Grayscale Performance	Very High	Continuous analog grayscale capability Transfer function a true power function
Viewing Angle	Very High	Effectively Lambertian viewing Contrast enhancement filters can attenuate luminance off axis
Color Gamut Ambient Color Gamut	High Low to Medium	Color gamut defined by OLED / PLED materials Specular reflections from metal cathode reduce color gamut under ambient lighting Circular polarizer can be used to enhance ambient color gamut
Physical Package	Very High	Very small footprint and light weight Very small depth required
Application Flexibility	Very high	Very amenable to portable or battery-powered applications Great flexibility in screen sizes
Other		Subject to internal specular reflections under ambient lighting Circular polarizer reduces luminance Differential aging of color materials can cause color shifts over time Active-matrix configurations subject to motion blur with dynamic imagery

10.3.3.2.4 Other Direct-View Emissive Display Technologies

Three additional emissive display technologies suitable for direct-view applications are electroluminescent (EL) displays, vacuum-fluorescent displays (VFD), and field-emitter displays (FED). Each of these technologies has been the subject of extensive development efforts and has achieved some success in limited application environments. They may be suitable for some specific applications but are generally not evolving and are being displaced by newer technologies.

Like the OLED and PLED devices, the EL display is particularly appealing due to its simple structure. Electroluminescence is the non-thermal conversion of electrical energy into luminous energy resulting from the application of an electrical field to a substance. The substance is typically a phosphor of the thin-film or powder type, and either ac or dc driving waveforms may be used. The combination of phosphor type and driving waveform gives rise to four types of EL devices. However, for high-resolution display applications, and particularly where the generation of color images is concerned, the dominant EL technology is the ac-driven thin-film EL display or TFEL (King, 1994).

The first commercial EL displays were introduced into the marketplace in 1983. These were monochrome devices, and today a full line of monochrome EL displays up to 1024×864 pixels is available. In 1993, the first multicolor EL display panels were introduced into the marketplace and the first full-color TFEL prototypes were demonstrated. EL technology is still used extensively for medical instrumentation displays because of its wide viewing angle and good form factor; however, it has steadily lost market share to LCD and OLED / PLED displays. In a VFD, cathode filaments are heated and emit electrons, which excite a phosphor-coated anode plate, emitting light. All components are enclosed in a glass envelope vacuum. To date, VFDs have succeeded in applications requiring small displays and the presentation of alphanumeric and limited graphical information. They are often found as indicator displays in a variety of electronic equipment (e.g., video cassette recorders, stereo equipment, test instruments) and have become a popular display technology for automobile dashboards. The quest for a thin, lightweight, low-power display with the desirable characteristics of a CRT, including full-color and grayscale capability, wide viewing angle, and high resolution, has led to the development of FEDs (Kumar, et al., 1994). In a basic FED, the electrons emitted by an array consisting of a very large number of localized “micro-tip” cold cathodes are accelerated onto a patterned phosphor screen. Color selection is achieved by creating a mosaic pattern of R-, G-, and B-emitting phosphors on the anode side of the panel that can be independently addressed via the cold-cathode array.

Problems in fabrication and reliability of cold-cathode arrays have limited interest in this technology, although some research and development efforts on materials and fabrication for improved cold-cathode arrays remain active. One direction that continues to see activity is the use of carbon nanotubes for the cathode arrays.

10.3.3.2.5 Emerging and Future Direct-View Emissive Display Technologies

At present, the only notable direct-view emissive display technology that is emerging and has demonstrated the potential for very high performance is the surface-conduction electron-emitter

display (SED). The SED is a flat-panel display technology that uses surface-conduction electron emitters for every individual display pixel. SEDs combine the slim form factor of LCDs and PDPs with the superior viewing angles, contrast, black levels, color gamut, and pixel response time of CRTs.

10.3.3.2.6 Direct-View Displays of the Non-Emissive Type

Non-emissive displays do not themselves generate light, but rather function to modulate some aspect of an extrinsic source of illumination. Non-emissive displays may be either transmissive, reflective, or transreflective. Virtually all high-performance color LCDs use a transmissive mode of operation and thus require an illumination source (a backlight). Higher-performance transreflective LCD configurations have become available for mobile display applications in recent years, but these displays still require an internal illumination source and do not achieve the contrast or color gamut of purely transmissive LCDs under benign ambient conditions. In general, non-emissive displays are low-power devices in that they themselves do not serve as a source of light. However, for other than applications where a totally reflective approach will suffice, some source of artificial illumination is required. One of the advantages of a non-emissive display is that the image-forming source (i.e., the light-controlling elements) and the source of illumination are decoupled. Thus, for a non-emissive display, luminance can be increased by using a more powerful illumination source without significantly affecting the image-forming components of the display.

10.3.3.2.7 Liquid Crystal Displays

Today LCDs dominate the display market for both mobile displays and high-performance computer monitors, and are rapidly gaining dominant market share for high-definition television displays.

The basic principle of operation of the LCD is that each element acts as a shutter that blocks or transmits light from a backlight. The shutter consist of a sandwich of two identically oriented polarizers, separated by a liquid crystal layer that in its “off” state rotates the light through an angle of 90°. In the “on” state, an applied electric field eliminates the rotation, and the light passes through both polarizers. Color filters are used to create a full-color display.

The backlight for most direct-view color LCDs is a cold-cathode fluorescent lamp. The current trend in LCD backlighting is the transition to the use of solid-state illumination sources such as LEDs or semiconductor laser sources (Anandan, 2006). LED backlights using arrays of RGB sources are now found in a number of active matrix LCDs and offer the benefits of a greatly enhanced color gamut and a display white point that is controllable at the backlight.

Recent techniques have resulted in dramatic improvements in LCD viewing angle performance and have enabled the development of large LCD panels used in direct-view LCD HDTVs and high-performance computer monitors. Recent advances have also been evident in optical designs for reflective and transreflective LCDs, resulting in improved display performance for dynamic ambient illumination environments.

Table 10.3-14 shows LCD technology attributes and their ratings for use as a display device.

Table 10.3-14 LCD Technology Attribute Ratings and Comments

Display Technology Attributes	General Rating	Comments
Spatial Addressability Spatial Resolution	Very High Very High	Very high pixel densities achievable Subpixel addressing techniques can improve effective resolution
Temporal Response	Medium	LC response limited by relaxation phase of LC switching Temporal aperture extended by sample-and-hold mode of operation
Luminance	Medium to High	Low optical throughput can be compensated by increased backlight power
Contrast Ambient Contrast	Medium to High Low to High	Black levels determined by light leakage from LC cell Ambient contrast limited by anti-glare and anti-reflection surface treatments and black matrix materials
Grayscale Performance	High	Continuous analog grayscale capability Transfer function generally a piecewise approximation to a power function
Viewing Angle	Medium to High	IPS and VA modes dramatically improve viewing angle performance Multidomain configuration further enhances viewing angles
Color Gamut Ambient Color Gamut	High to Very High Low to High	Color gamut defined by backlight SPD and color filter selectivity LED backlights enhance color gamut Ambient color gamut limited by antiglare and antireflection surface treatments and black matrix materials

Display Technology Attributes	General Rating	Comments
Physical Package	Very High	Small footprint and relatively low weight Small depth required
Application Flexibility	Very High	Amenable to portable or battery-powered applications Supports the broadest range of screen sizes
Other		Subject to motion blur with dynamic imagery due to AM sample-and-hold behavior and LC response time

10.3.3.2.8 Other Direct-View Non-Emissive Display Technologies

Two additional non-emissive display technologies suitable for direct-view applications are electrophoretic displays and interferometric modulator (iMod) displays. Each of these technologies has been the subject of extensive development efforts and to date has achieved some success in limited application environments. These technologies are evolving but are likely to remain suitable only for a limited range of display applications.

Electrophoretic displays operate only in the reflective mode and exhibit a high degree of reflectivity relative to LCDs operated in a reflective or transmissive mode. The nature of the particle reflection is diffuse and approaches a Lambertian distribution. This imparts a paper-like appearance to monochromatic electrophoretic displays. The contrast of the display is limited and, although full-color operation can be achieved through the addition of color filters, the color saturation is low and the absorption of the filters greatly reduces the reflectivity. Electrophoretic displays are most suitable for electronic paper displays (e.g., electronic book displays), small reflective indicators, and digital signage applications.

Interferometric modulator (iMoD) displays are direct-view, reflective imaging devices based on micro-electromechanical systems (MEMS) technology (Sampsel, 2006). The iMoD displays operate only in the reflective mode and exhibit a high degree of reflectivity relative to LCDs operated in a reflective or transmissive mode. The nature of the interference reflection is specular, and as a result it is challenging to achieve a wide and homogeneous viewing angle with such devices. The contrast of the iMoD is limited by reflections from the front surface of the device as well as by structures surrounding the pixels and diffusing films required to distribute the specular reflection. Unlike electrophoretic displays, high-reflectivity full-color operation is readily achieved with the iMoD, although the color saturation is low due to the limited contrast of the device. These displays are most suitable for mobile display applications due to their very high reflectivity and full-color operation under ambient illumination. Digital signage is another potential application for the iMoD.

10.3.3.2.9 Emerging and Future Direct-View Non-Emissive Display Technologies

A number of direct-view, non-emissive display technologies are currently under active development. At present, two of these technologies are notable for their demonstrated progress and application potential. These are electrochromic displays and electro-wetting displays. Electrochromic displays have been the subject of intermittent research and development for many years, but have had limited success at commercialization (Sampsel, 2006). This situation is likely to change with recent significant advances in materials for electrochromic displays. This technology relies on the use of an electric current to reversibly oxidize or reduce a colored dye and change its color, or reversibly deposit a metal on a surface. The color change can be between two colors, or between a colored state and a transparent state. A white reflector can be used to form a high-reflectance white state or provide a colored background. Electrochromic displays have excellent viewing angle performance, and are capable of achieving moderate levels of contrast and grayscale. Full-color performance is difficult to achieve and stability of electrochromic displays is a persistent concern since few electrochemical reactions are 100 percent reversible.

Electro-wetting displays are an emerging technology that relies on fluid flow controlled by an electric field (Sampsel, 2006). The electro-wetting display offers various configurations for full-color operation and can be operated as a hybrid device using both a subtractive color optical stack with cyan, magenta, and yellow oils and additive spatial color with different color sub-pixels. Although electro-wetting displays are still in an early stage of development, they have already demonstrated many positive attributes. These include full-color capability, grayscale, wide viewing angle, video-rate switching, both reflective and transmissive modes of operation, and very good optical efficiency. To date prototypes have shown only moderate display contrast and color saturation. Electro-wetting displays are currently most suitable for mobile display applications.

10.3.3.3 Projection Displays

Projection displays are a category of display technology that generates images that are not viewed directly by an observer. Rather, the image is relayed or projected from the image source to another surface or screen for viewing (Stupp & Brennesholtz, 1999). There are many types of projection displays, which can be classified according to the imager technology of the projection engine, the system optical design, and the screen configuration.

The principal types of imagers used in current projection displays are CRTs, liquid crystal light valves of both the transmissive and reflective type, and imagers based on MEMS. A wide range of projection optical systems are available, and projection displays can be further classified into front-projection systems, rear-projection systems, and virtual displays. Both front- and rear-projection systems typically involve magnification of the source image. In front-projection systems the screen is reflective, and the projection engine and the viewer(s) are on the same side of the screen. Rear-projection systems use transmissive screens, and the projection engine and viewer(s) are on opposite sides of the screen. The same projection engine can sometimes be used in both front- and rear-projection configurations. Virtual displays do not generate a real image that can be viewed on a physical screen. Instead a virtual image of diverging rays is relayed or projected directly to the retina of the viewer and focused by the optics of the eye.

These displays can be used in either front- or rear-projection applications. Virtual displays, which involve a unique set of optical and visual requirements, are themselves a complex topic and are not included in these sections. Projection screens strongly affect the viewing characteristics and image quality of projection display systems. They must be carefully selected and matched to the projection engine to achieve optimal performance of a projection display system for a particular application and viewing environment. Despite their importance, the many types of projection screens and screen parameters are too application-specific to consider in a general overview of projection displays.

10.3.3.3.1 Projection Displays Using CRT Imagers

Full-color projection displays using CRT sources typically consist of three CRTs, one each for the R, G, and B image components. Additional components are required for combining and aligning the three primary color images, and projection optics are needed to relay the images to a suitable front- or rear-projection screen.

Projection display systems based on CRTs have achieved good color performance and image quality. The approach is constrained by all of the technical limitations of CRTs, especially limits on image luminance and the negative relation between luminance and resolution resulting from CRT spot growth with increasing beam current. Additional problems include convergence or registration of the three primary color images, geometric distortions from both the CRTs and the optical system, CRT faceplate cooling, and system drift over time. As with all projection display systems, the projection screen limits image contrast under ambient illumination, and rear-projection screens using lenticular optical structures restrict the viewing angle of the system. Table 10.3-15 shows PDP technology attributes and their ratings for use as a display device.

Table 10.3-15 CRT-Based Projection Display Attribute Ratings and Comments

Display Technology Attributes	General Rating	Comments
Spatial Addressability Spatial Resolution	Very High Medium to High	Gaussian beam reduces spatial noise but limits optical resolution Luminance and resolution negatively correlated Projection optics and screen limit resolution
Temporal Response	High	Phosphors with short and medium-short persistence exhibit narrow impulse response
Luminance	Low to Medium	Monochrome CRTs capable of moderate to high luminance Magnification and optical losses limit luminance
Contrast Ambient Contrast	Medium to High Low to Medium	Excellent black levels Diffuse reflectance from screen limits ambient contrast
Grayscale Performance	Very High	Continuous analog grayscale capability Transfer function a true power function
Viewing Angle	Low to Medium	Projection screen limits viewing angle
Color Gamut Ambient Color Gamut	High Low to Medium	Color gamut defined by phosphor SPD Diffuse reflection from screen reduces color gamut under ambient lighting
Physical Package	Low	Large, bulky, and heavy Substantial depth required
Application Flexibility	Low	Not amenable to portable or battery-powered applications Limited to large screen sizes
Other		Subject to various geometric distortions such as barrel, pincushion, and trapezoidal Subject to misregistration of primary color images Subject to flicker due to impulse response – requires high refresh rates

10.3.3.3.2 Projection Displays Using Liquid Crystal Imagers

The liquid crystals can be applied directly to the surface of a silicon chip and used as reflective surface to produce images. This technology is referred to as liquid crystal on silicon or LCoS. As matrix-addressed display devices, LC light valves or spatial light modulators (SLMs) are not subject to the geometric distortion or luminance / resolution tradeoffs of CRTs. Moreover, the separation of the image-forming source and illumination source in LC-based projection systems affords great flexibility for the design of a compact projection display with enhanced lumen

output. High-efficiency projection light sources such as metal-halide arc lamps are typically used in LC-based projection systems.

Table 10.3-16 LC Imager-Based Projection Display Attribute Ratings and Comments.

Display Technology Attributes	General Rating	Comments
Spatial Addressability Spatial Resolution	Very High Medium to High	Very high pixel densities achievable LCoS can achieve higher pixel densities than transmissive light valves Projection optics and screen limit resolution
Temporal Response	Medium to High	LC response limited by relaxation phase of LC switching Temporal aperture extended by sample-and-hold mode of operation LCoS capable of faster LC response times and reduced sample-and-hold time
Luminance	Medium to High	Low optical throughput can be compensated by increased backlight power LCoS has higher light throughput efficiency than transmissive light valves
Contrast Ambient Contrast	Medium to High Low to Medium	Black levels determined by light leakage from LC cell Diffuse reflectance from screen limits ambient contrast
Grayscale Performance	High	Continuous analog grayscale capability Transfer function generally a piecewise approximation to a power function
Viewing Angle	Low to Medium	Projection screen limits viewing angle
Color Gamut Ambient Color Gamut	High Low to High	Color gamut defined by projection light source and selectivity of dichroic elements Diffuse reflection from screen reduces color gamut under ambient lighting
Physical Package	Medium	Projection engine relatively compact Rear projection requires substantial depth
Application Flexibility	Low to Medium	Not amenable to portable or battery-powered applications Generally used for large screen sizes
Other		Transmissive LC light valves subject to motion blur with dynamic imagery due to AM sample-and-hold behavior and LC response time Transmissive LC light valves subject to “screen-door effect” due to low aperture ratio LCoS only minimally susceptible to motion blur and “screen-door effect”

10.3.3.3 Projection Display Using MEMS Imagers

Reflective imagers or SLMs based on MEMS technology have become an important technology for projection displays (Sampsell, 2006). The dominant MEMS technology for projection applications is the digital mirror device (DMD), which has also been designated as the digital light processing (DLP) technology. The single-chip DMD projection engines using field-sequential color synthesis constitute a relatively low-complexity, low-cost approach and are typical in projection systems for consumer applications such as HDTV and portable data projectors. The three-chip DMD engines are much more complex and costly and generally are found in commercial applications such as electronic cinema projectors.

Another MEMS imager that is currently being used for projection display applications is the grating light valve (GLV) (Sampsell, 2006). The GLV is most effective when used in conjunction with laser illumination. Given the complexity of the GLV projection optical system and the need for lasers to achieve very high image quality, the GLV is currently restricted in its application to very high-end and costly projection systems such as those for electronic cinema and specialized visual simulation systems. GLV displays can accommodate very high frame rates with effectively zero motion blur.

Table 10.3-17 MEMS Imager-Based Projection Display Attribute Ratings and Comments

Display Technology Attributes	General Rating	Comments
Spatial Addressability	Very High	Very high pixel densities achievable
Spatial Resolution	Medium to High	Projection optics and screen limit resolution
Temporal Response	Medium to High	MEMS device response extremely fast Temporal aperture extended by sample-and-hold mode of operation
Luminance	Medium to Very High	MEMS devices capable of handling very high optical power levels PWM and large number of subframes for grayscale reduce luminance potential
Contrast	Medium to High	Black levels determined by projection optical system design and complexity
Ambient Contrast	Low to Medium	Diffuse reflectance from screen limits ambient contrast
Grayscale Performance	Medium	PWM, linear transfer function, and temporal subframe structure result in non-optimal grayscale performance
Viewing Angle	Low to Medium	Projection screen limits viewing angle
Color Gamut	High	Color gamut defined by projection light source and color filters if present
Ambient Color Gamut	Low to High	Diffuse reflection from screen reduces color gamut under ambient lighting
Physical Package	Medium	Projection engine relatively compact

Application Flexibility	Low to Medium	Rear projection requires substantial depth Not amenable to portable or battery-powered applications
Other		Generally used for large screen sizes Subject to contouring artifacts at low gray levels Subject to perceptible motion artifacts when viewing dynamic imagery Field-sequential color configurations subject to color breakup and flicker

10.3.3.3.4 Emerging and Future Projection Display Technologies

Currently the most active research and development efforts for emerging and future projection display technologies are in the areas of illumination sources for projection, projection screens, and image and color processing. Projection illumination sources are rapidly evolving toward solid-state illumination. LED projection sources are currently on the market, and semiconductor laser sources have made great advances in recent years. These improved sources offer greatly expanded color gamuts, higher potential luminance, longer source life, and reduced warm-up times. In addition, they provide opportunities for improved projection display system concepts resulting from fast switching times, improved beam spread, and spectral selectivity. Advances in projection screens are currently focused on improved screen contrast under ambient illumination, viewing angle control, reduced spatial screen noise, improved uniformity, and enhanced optical efficiency. Many opportunities for the enhancement of projection system performance and image quality are being provided by new methods in image and color processing, with major emphasis on wide-gamut color, image sharpening, noise and artifact reduction, and algorithms for calibration and seamless appearance of tiled projected images.

10.3.3.4 Related Display Standards

Many display standards are very device-specific. They are written in terms of the prevailing technology at the time (e.g., shadow-mask color CRT), and may not be relevant to new technologies. Because of this, many are now obsolete, or will be in the near future. Another problem is that in many cases they intermix standards regarding the display itself with standards regarding display content.

- Video Electronics Standards Organization VESA (2001), Flat-Panel Display Measurements Standard

First published by the Video Electronics Standards Organization (VESA) in 1998 and updated in 2001 and 2005, this document is a concise description of a large set of basic measurements. While described as a “standard,” it does not set acceptable values, but only specifies how they need to be measured. It is widely cited by other standards documents, and by display manufacturers. As its name implies, it is focused primarily on flat-panel displays, though many of the measurements are appropriate for CRTs as well.

The primary section headings are “Set Up of Display and Equipment,” “Center Measurements of Full Screen,” “Detail,” “Resolution and Artifacts,” “Box-Pattern Measurements,” “Temporal

Performance,” “Uniformity,” “Viewing Angle Performance,” and “Reflection.” It includes measurements of luminance, contrast, color gamut, gamma, resolution, pixel defects, mura defects, spatial uniformity, viewing angle effects, reflections, response time, residual image, and flicker.

A 2005 update, published as a separate document, is concerned primarily with motion artifacts such as motion blur and perceptually equal gray shade intervals, which is a common artifact in LCD and other hold-type displays. A full update is planned, but this successor document may appear under the auspices of the ICDM, a committee of the Society for Information Display.

- ISO 13406-2 (ISO, 2001) – Ergonomic Requirements for Work with Visual Displays Based on Flat Panels - Part 2: Ergonomic Requirements for Flat Panel Displays (ISO13406)

This standard was released in 2001 and was intended to augment or replace ISO 1992, which dealt mainly with CRTs. It is focused on ergonomic aspects of displays, and devotes considerable attention to user-display configuration. It also deals with display content, such as character dimensions and legibility. It includes standards for color uniformity, character dimensions, luminance, contrast, reflections, luminance uniformity, pixel defects, image formation time, flicker, and number of colors.

- Human Factors and Ergonomics Society (2007), ANSI / HFES 100 – Human Factors Engineering of Computer Workstations, Chapter 7- Visual Displays

Published in 2002, this document is under revision, and is discussed here and referred to elsewhere in this chapter as the Second Canvas Draft, dated 2006. This document resembles ISO13406 in its ergonomic and user-centered emphasis, and also in its specific content. The main section headings are “Viewing Characteristics,” “Spatial Characteristics,” “Temporal Quality,” and “Information Format.” The last heading refers primarily to text.

- MIL-STD-1472 Revision F Human Engineering, Section 5.2: Displays (MIL1472)

Published in 1999, this standard deals largely with traditional single-purpose displays such as lights and indicators. It contains a few specific requirements for head-up displays (HUDs), helmet-mounted displays (HMDs), and stereoscopic displays.

- NASA-STD-3000, Section 9.4.2 Visual Displays

This document discusses design requirements for contrast, reflections, vibration, and display size. Some requirements for information presentation are also given, as well as special requirements for large-screen projection displays. Requirements for various indicators are given. A section on visual display terminal design requirements discusses resolution, luminance, contrast, glare, flicker, viewing distance, and viewing angle. Requirements are given for text dimensions.

- TCO’06 Media Displays, TCOF1076 Version 1.2, 2006-08-16 (TCO06)

TCO, a European company, provides standards and certification services for displays. In addition to TCO’06, they offer TCO’03 Displays, TCO’05 Notebooks, and TCO’05 Desktops.

TCO'06, published in 2006, provides standards for displays of moving pictures, such as TV. The main headings are "Pixel Array Characteristics," "Luminance Characteristics," "Luminance Contrast Characteristics," "Screen Color Characteristics," and "Video Reproduction."

- International Committee on Display Metrology (ICDM) Display Measurement Standard (DMS)

Planned as an open-access successor to the VESA (2001), the ICDM DMS Version 1.0 is expected to be published in June 2009, and available at <http://icdm-sid.org/>. Like the VESA (2001), this document provides concise explicit descriptions of measurement methods, analyses, and metrics. The ICDM is sponsored by the Society for Information Display (<http://www.sid.org/>).

10.3.4 Research Needs

TBD

10.4 CONTROLS

Controls in a spacecraft include any method of interaction in which the user enters information into a system. They may be in the form of physical cockpit flight controls (hand controllers and switches), or computer input devices such as a mouse, touch screen, or keyboard.

The type of device needed for a task depends on the type of task, the user, and the environment. Specifically, the manipulation of controls during spacecraft acceleration, or while in a spacesuit, requires unique consideration. This section describes the factors that must be considered in control selection and layout in a spacecraft.

10.4.1 Control design and operation

- The size of a control should ensure optimal operation by the expected body part (e.g., finger, hand, foot) of the smallest and largest crewmember, including the expected clothing such as a spacesuit, boots, and gloves.

For example, a knob that must be turned by a suited glove must be large enough that it can be activated comfortably with at least two fingers of any crewmember.

Control size is often an indication of how it is to be used, and aids in recognition.

- Use large controls (e.g., lever on a hatch) for high forces and gross motor actions.
- Use small controls (e.g., a trackball) for low forces and high precision.
- To prevent accidental actuation, the resistive force should be sufficient to support the resting weight of the operating body part (e.g., finger, hand, foot). The resistive force must be large enough to prevent unintended drifting or changing of position due to vehicle movements.
- Controls must be operable by the weakest crewmember (taking into account the effect of any 0g or partial-g deconditioning).

- For repeated operations, the force should not be great enough to cause fatigue.

See section 4.7 Strength for more information.

10.4.2 Control Devices

Control devices come in many different forms. Below is a description of input devices, applications for which they are most appropriate, and guidelines for their design.

10.4.2.1 Push Button

Push buttons allow efficient use of volume and/or space, and they are easy and fast to activate. However, their state of activation is sometimes difficult to identify. They are susceptible to inadvertent activation.

- Push buttons should be used when a control or an array of controls is needed for momentary contact or for actuating a locking circuit, particularly in high-frequency-of-use situations.
- Push buttons should not be used for discrete control where the function status is determined exclusively by a position of the switch.

10.4.2.1.1 Shape

- The push button surface should be concave (indented) to fit the finger. When this is impractical, the surface should provide a high degree of frictional resistance.
- Large, hand- or fist-operated, mushroom-shaped buttons should be used only as “emergency stop” controls.

10.4.2.1.2 Positive Indication

- A positive indication of control activation must be provided (e.g., snap feel, audible click, or integral light).

10.4.2.1.3 Channel or Cover Guard

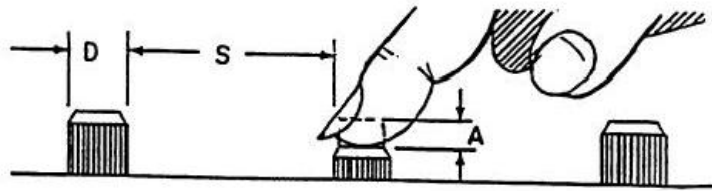
- A channel or cover guard should be provided when accidental actuation of the control needs to be prevented. When a cover guard is in the open position, it should not interfere with operation of the protected device or adjacent controls.

10.4.2.1.4 Dimensions, Resistance, Displacement, and Separation

- Except for use of push buttons in keyboards, control dimensions, resistance, displacement, and separation between adjacent edges of finger or hand-operated push buttons should conform to the criteria in 10.6-7.

10.4.2.1.5 Interlocks or Barriers

Mechanical interlocks or barriers may be used instead of the spacing required by Figure 10.4-1.



	DIMENSIONS (Diameter, D)						RESISTANCE		
	Fingertip		Thumb		Palm		Single Finger	Different fingers ¹	Thumb/Palm
	Bare hand	Gloved hand	Bare hand	Gloved hand	Bare hand	Gloved hand			
MIN	10 mm (0.4")	19 mm (0.75")	19 mm (0.75")	25 mm (1.0")	40 mm (1.6")	50 mm (2.0")	2.8 N 10 oz	1.4 N (5 oz)	2.8 N (10 oz)
MAX	25 mm (1.0")	—	25 mm (1.0")	—	70 mm (2.8")	—	11.0 N (40 oz)	5.6 N (20 oz)	23.0 N (80 oz)

	DISPLACEMENT (A)	
	Fingertip	Thumb or Palm
MIN	2 mm (0.08")	3 mm (0.12")
MAX	6 mm (0.25")	38 mm (1.5")

	SEPARATION (S)				
	Single Finger		Single Finger	Different Fingers	Thumb or Palm
	Bare	Gloved	Sequential		
MIN	13 mm (0.5")	25 mm (1.0")	6 mm (0.25")	6 mm (0.25")	25 mm (1.0")
PREF	50 mm (2.0")	—	13 mm (0.5")	13 mm (0.5")	150 mm (6.0")

¹Actuated at same time

NOTE: Where gloved hand criteria are not provided, minima should be suitably adjusted.

Figure 10.4-1 Requirements for push buttons (finger- or hand-operated). Source: MIL-STD-1472F

10.4.2.2 Foot-Operated Switches

10.4.2.2.1 Use

Foot-operated switches are susceptible to inadvertent activation and should be limited to non-critical operations. Furthermore, they are not recommended for fine adjustments, because the foot is not able to make fine motor movements. Lastly, frequent use of foot-operated switches should be avoided.

- Foot-operated switches are useful when the hands are occupied, but should not be used for frequent or critical operations, or when foot restraints are needed.

10.4.2.2.2 Operation

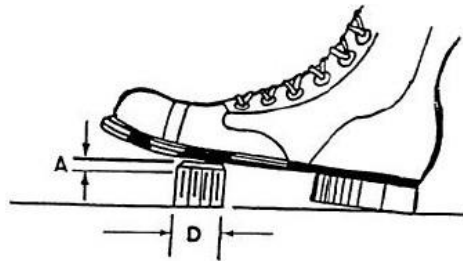
- Foot switches should be designed for operation by the toe and the ball of the foot rather than by the heel.
- They should be located so that the operator can center the ball of the foot on the switch button without interference. A pedal may be used over the button to aid in locating and operating the switch.
- If the switch may become wet and slippery, the switch cap surface should provide a high degree of frictional resistance.

10.4.2.2.3 Dimensions, Resistance, and Displacement

- Dimensions, resistance, and displacement of foot-operated switches should conform to the criteria in Figure 10.4-2.
- While only one switch per foot is preferred, when one foot must be used to operate more than one switch, such switches should be a horizontal distance of at least 75 mm (3 in.) apart and a vertical distance of at least 200 mm (8 in.) apart.

10.4.2.2.4 Feedback

- A positive indication of control actuation should be provided (e.g., snap feel, audible click, or associated visual or audio display).



	DIAMETER	RESISTANCE		DISPLACEMENT			
	D	Foot Will Not Rest On Control	Foot Will Rest On Control	Normal Operation	Heavy Boot Operation	Ankle Flexion Only	Total Leg Movement
Minimum	13 mm (0.5 in.)	18 N (4 lb)	45 N (10 lb)	13 mm (0.5 in.)	25 mm (1 in.)	25 mm (1 in.)	25 mm (1 in.)
Maximum		90 N (20 lb)	90 N (20 lb)	65 mm (2.5 in.)	65 mm (2.5 in.)	65 mm (2.5 in.)	100 mm (4 in.)

Figure 10.4-2 Requirements for foot-operated switches. Source: MIL-STD-1472F.

10.4.2.3 Keyboard

10.4.2.3.1 Use

- Arrangements of push buttons in the form of keyboards should be used when alphabetic, numeric, or special function information is to be entered into a system.

10.4.2.3.2 Layout of Keys

- Keys should be grouped according to their function, based on convention. Groupings can include numeric keys, alphabetical keys, and function keys.
- The specific arrangement of keys should match the standards used in keyboards with similar functions.

For example: Alphabetical Keys – The QWERTY layout is the standard for alphabetical keys. Other keyboard formats exist (such as the Dvorak layout) and have ergonomic advantages, but are not as widely used as the QWERTY layout. The Dvorak layout is defined in ANSI, 1991.

10.4.2.3.3 Numeric Keys

Two standard layouts are used for numeric keys: the telephone layout and the calculator layout (see Figure 10.4-3).

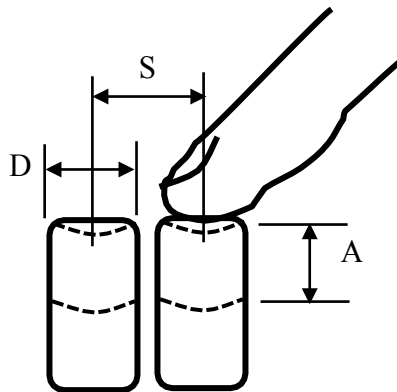
Telephone Keypad Layout		
1	2	3
4	5	6
7	8	9
	0	

Calculator Keypad Layout		
7	8	9
4	5	6
1	2	3
	0	

Figure 10.4-3 Standardized numeric keyboard layouts.

10.4.2.3.4 Key Displacement

Recommendations for keyboard key dimensions, separation, resistance, and displacement are in Figure 10.4-4.



	DIMENSIONS (D)	RESISTANCE (R)		
		Permitted at Snap Point	Preferred at Snap Point	Initial Resistance
MIN	12 mm (0.47 in)	0.25 N* (0.9 oz)	0.5 N (1.8 oz)	25% of R at snap point
MAX	--	1.5 N (5.4 oz)	0.6 N (2.2 oz)	75% of R at snap point

DISPLACEMENT (A)

	Permitted (continuous entry use)	Preferred	Acceptable for Non-Continuous Entry
MIN	1.5 mm (0.04 in)	2.0 mm (0.08 in)	0.7 mm (0.03 in)
MAX	6.0 mm (0.24 in)	4.0 mm (0.16 in)	1.6 mm (0.06 in)

SEPARATION (S)

Measured between centerline of any two adjacent keys (without gloves)

MIN	18 mm (0.70 in)
MAX	20 mm (0.78 in)

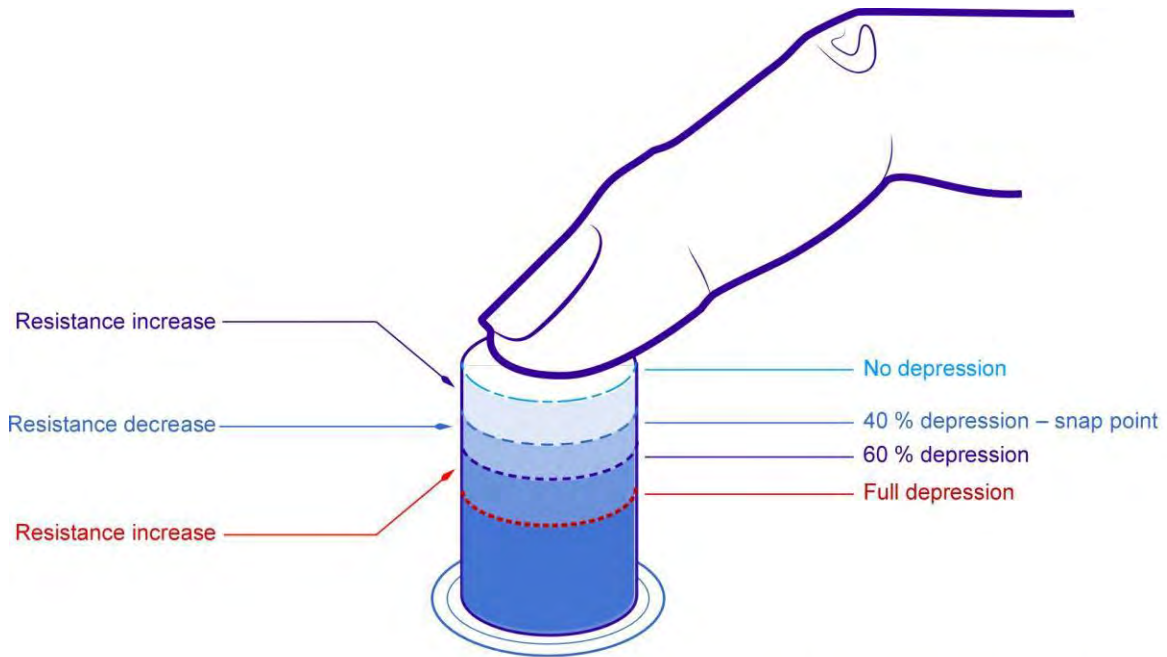
Figure 10.4-4 Requirements for keyboard keys. *N, Newton. Source: MIL-STD-1472F, Human Factors and Ergonomics Society (2007)

10.4.2.3.5 Keystroke Feedback

Keystroke feedback can be auditory, tactile, or both.

- Tactile feedback is preferred in space environments because the background noise may prevent the crewmember from hearing auditory feedback.
- If the feedback is auditory, it should occur at a consistent point in the displacement of all the keys.

Changes in the key resistance can provide tactile feedback. Figure 10.4-5 shows the recommended force profile for user feedback.

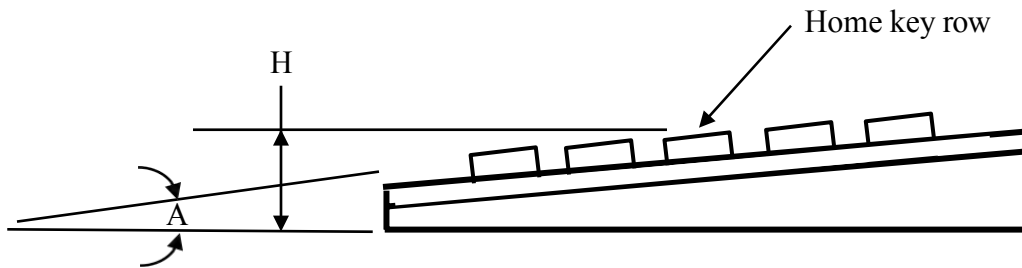


Source: International Standard ISO 9241-4:1998

Figure 10.4-5 Tactile feedback recommendations.

10.4.2.3.6 Keyboard Height and Slope

- Figure 10.4-6 shows recommendations for keyboard slope and height.



	KEYBOARD SLOPE (A)		KEYBOARD HEIGHT (H)	
	Permitted	Preferred	Permitted	Preferred
MIN	0°	5°	–	–
MAX	15°	12°	35 mm (1.4 in)	30 mm (1.2 in)

Figure 10.4-6 Requirements for keyboard slope and height. Source: ISO 1992.

10.4.2.3.7 Key Repeat Rate

- If a key is held for longer than 500 milliseconds, the character should repeat at a rate of approximately 10 characters per second. This character repeat rate should be adjustable.

10.4.2.3.8 Home Row Locator

- The keyboard should have at least one tactile feature that helps initial finger positioning.

For the QWERTY keyboard, this could be a dimple or raised area on the “F” and “J” keys. Similarly, this could be a tactually distinguishable feature at the center “5” on a numeric keyboard.

10.4.2.4 Toggle Switch

10.4.2.4.1 Use

A toggle switch is a switch that uses a toggle joint with a spring to open or close an electric circuit as an attached lever is pushed through a small arc. Toggle switches provide an efficient use of space. As in the case of levers, the status of the toggle switch is intuitive to the user; it is easy to identify which position it is in.

- Toggle switches should be used where two discrete control positions are required or where space limitations are severe.
- Toggle switches with three positions should be used only where the use of a rotary control or legend switch control is not feasible or when the toggle switch is spring-loaded to a center-off position.
- Three-position toggle switches with spring-loaded to center-off, should not be used if release from the spring-loaded position results in switch handle travel beyond the off position.

10.4.2.4.2 Accidental Actuation

Toggle switches are susceptible to inadvertent activation, and because of this they often require guards or shields. Preventing accidental actuation is important (i.e., to prevent critical or hazardous conditions).

- Channel guards, lift-to-unlock switches, or other equivalent prevention mechanisms should be provided to prevent inadvertent activation.
- Safety or lock wire should not be used.
- Resistance of lift- to-unlock mechanisms should not exceed 13 N (3 lb).
- An open cover guard should not interfere with the operation of the protected device or adjacent controls.

10.4.2.4.3 Dimensions, Resistance, Displacement, and Separation

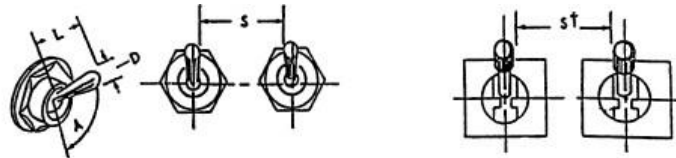
- Dimensions, resistance, displacement, and separation between adjacent edges of toggle switches should be as shown in Figure 10.4-7. The recommended separation dimensions are for bare-handed operations.
- Resistance should gradually increase, then drop when the switch snaps into position.
- The switch should not be capable of being stopped between positions.

10.4.2.4.4 Positive Indication

- An indication of control actuation must be provided (e.g., snap feel, audible click, or associated or integral light).

10.4.2.4.5 Orientation

- Toggle switches should be vertically oriented with OFF in the down position.
- Horizontal orientation and actuation of toggle switches should be used only for compatibility with the controlled function or equipment location.



	DIMENSIONS			RESISTANCE	
	L Arm Length		D Control Tip	Small Switch	Large Switch
	Use by bare finger	Use with heavy handwear			
Minimum	13 mm (0.5")	38 mm (1.5")	3 mm (0.125")	2.8 N (10 oz)	2.8 N (10 oz)
Maximum	50 mm (2.0")	50 mm (2.0")	25 mm (1.0")	4.5 N (16 oz)	11 N (40 oz)
DISPLACEMENT BETWEEN POSITIONS					
	Two Position		Three Position		
Minimum	30°		17°		
Maximum	80°		40°		
Preferred	---		25°		
SEPARATION, S					
	Single Finger Operation		Single Finger	Simultaneous Operation	
	Normal	Lever Lock Switch	Sequential Operation	by Different Fingers	
Minimum	19 mm (0.75")	25 mm (1.0")	13 mm (0.5")	16 mm (0.625")	
Optimum	50 mm (2.0")	50 mm (2.0")	25 mm (1.0")	19 mm (0.75")	

Figure 10.4-7 Requirements for toggle switches. Source: MIL-STD-1472F.

10.4.2.5 Legend Switches

Legend switches are a special type of push-button switch and are used to display qualitative information on system status.

10.4.2.5.1 Dimensions, Resistance, Displacement, and Separation

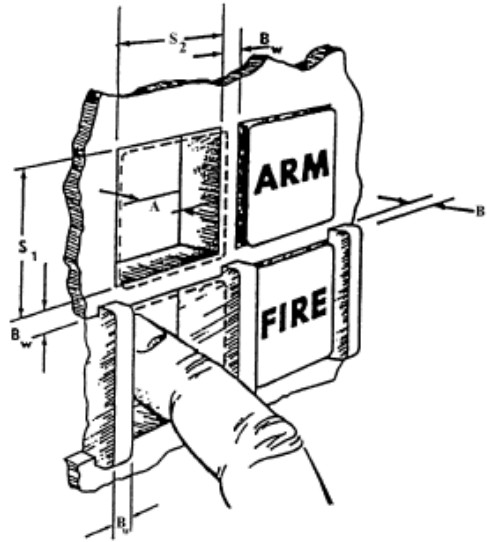
- Dimensions, resistance, displacement, and separation between adjacent edges of legend switches should conform to the criteria in Figure 10.4-8, except that maximum switch separation does not apply to nonmatrix applications.

10.4.2.5.2 Barrier Height

- Barrier height from panel surface should conform to the criteria in Figure 10.10-5.
- Unless otherwise specified, barriers are required on critical switches and on switches likely to be inadvertently actuated.
- Barriers, when used, should not obscure visual access to controls, labels, or displays, and should have rounded edges.

10.4.2.5.3 Other Requirements

- The legend switch should be provided with a detent or click for positive indication of switch actuation. When touch-sensitive switches are used, a positive indication of actuation must be provided, e.g., an integral light within or above the switch being actuated.
- The legend should be legible with or without internal illumination.
- A lamp test or dual lamp / filament reliability test should be provided for switches if the mean time between failures is less than 100,000 h.
- Lamps within the legend switch should be replaceable from the front of the panel by hand and the legends or covers should be keyed to prevent the possibility of interchanging the legend covers.
- A legend plate should not contain more than three lines of lettering.
- Legend switches should be distinguishable from legend lights.



	SIZE (S ₁ AND S ₂)		BARRIERS	
	Bare Hand	Gloved Hand	Width (B _w) ²	Depth (B _d)
MINIMUM	19 mm (0.75") ¹	25 mm (1.0")	3 mm (0.125")	5 mm (0.2")
MAXIMUM	-	38 mm (1.5")	-	-

	DISPLACEMENT		
	Standard Legend Switch	Membrane/Tactile Legend Switch	
		Dome snap-action contact	Conductive membrane contact
MINIMUM	3 mm (0.125")	7 mm (0.03")	5 mm (0.2")
MAXIMUM	6 mm (0.25")	1 mm (0.04")	1 mm (0.04")

	RESISTANCE		
	Standard Legend Switch	Membrane/Tactile Legend Switch	
		Dome snap-action contact	Conductive membrane contact
MINIMUM	2.8 N (10 oz) ⁴	1.5 N (5 oz)	2.0 N (7 oz)
MAXIMUM	16.7 N (60 oz)	2.5 N (9 oz)	3.0 N (11 oz)

¹15 mm (0.65") where switch is not depressed below the panel.

²B_w also refers to switch separation.

³5 mm (0.2") for positive switches.

⁴5.6 N (20 oz) for use in moving vehicles.

Figure 10.4-8 Requirements for legend switches. Source: MIL-STD-1472F.

10.4.2.6 Rocker Switches

10.4.2.6.1 Use

A rocker switch is an on/off switch that rocks (rather than trips) when pressed, which means one side of the switch is raised while the other side is depressed, much like a rocking horse rocks back and forth.

- Rocker switches may be used in lieu of toggle switches for functions requiring two discrete positions, particularly where toggle switch handle protrusions might snag the operator, or where there is insufficient panel space for separate labeling of switch positions.
- Rocker switches with three positions should be used only where the use of a rotary control or legend switch control is not feasible or when the rocker switch is of the spring-loaded center-off type.

Rocker switches provide efficient use of space, and their status is intuitive. However, they are susceptible to inadvertent activation.

10.4.2.6.2 Accidental Actuation

- When accidental actuation needs to be prevented to avoid critical or hazardous conditions, channel guards or equivalent protection should be provided.

10.4.2.6.3 Positive Indication

- An indication of control actuation must be provided (e.g., snap feel, audible click, associated or integral light).

10.4.2.6.4 Dimensions, Resistance, Displacement, and Separation

- Dimensions, resistance, displacement, and separation between centers of rocker switches should conform to the criteria in Figure 10.4-9.
- Resistance should gradually increase, then suddenly decrease when the switch snaps into position.
- The switch should not be capable of being stopped between positions.

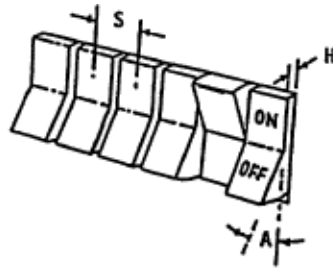
10.4.2.6.5 Orientation

- Where practicable, rocker switches should be vertically oriented.
- Actuation of the upper wing should turn the equipment or component on, cause the quantity to increase, or cause the equipment or component to move forward, clockwise, to the right, or up.
- Horizontal orientation of rocker switches should be used only for compatibility with the controlled function or equipment location.

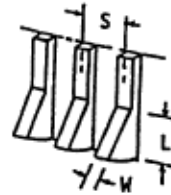
10.4.2.6.6 Color and Illumination

Alternate colors may be used to denote the ON and OFF portions of a rocker switch. Alternate illumination of either the ON or OFF switch position may be used to facilitate positive recognition of current switch position.

- Rocker switches should be internally illuminated when ambient illumination will provide display luminance below 3.5 cd/m² (1 Ft-L).
- Digits and letters should appear as illuminated characters on an opaque background and their dimensions should approximate the following: height: 4.8 mm (3/16 in.); height-to-width ratio: 3:2; height-to-stroke-width ratio: 10:1.



STANDARD ROCKER SWITCH:
USE AS ALTERNATE TWO-POSN
TOGGLE SWITCH TO PROVIDE
LABELING SURFACE, EASE OF
COLOR CODING, SWITCH
ILLUMINATION.



NARROW WIDTH, ESPECIALLY
DESIRABLE FOR TACTILE
DEFINITION WITH GLOVES.



ALTERNATE (CONTRAST) COLOR
FOR ON VERSUS OFF TO PROVIDE
CONSPICUOUS CUE OF SWITCH
POSITION. ILLUMINATED "ON"
DESIRABLE AS SECOND FEEDBACK
CUE.



	DIMENSIONS		RESISTANCE	
	W, WIDTH	L, LENGTH		
MINIMUM	6 mm (0.25")	13 mm (0.5")	2.8 N (10 oz.)	
MAXIMUM			11 N (40 oz.)	

	DISPLACEMENT		SEPARATION (Center-to-Center)	
	H, DEPRESSED	A, ANGLE	S (Bare Hand)	S (Gloved Hand)
MINIMUM	3 mm (0.125")	530 mrad (30°)	19 mm (0.75")	32 mm (1.125")

Figure 10.4-9 Requirements for rocker switches. Source: MIL-STD-1472F.

10.4.2.7 Slide Switch Controls

10.4.2.7.1 Use

Slide switches have a sliding button, bar, or knob. They can be discrete or continuous.

- Slide switch controls may be used for functions that require a larger number of discrete positions in which the switches are arranged in a matrix to permit easy recognition of relative switch settings (e.g., audio settings across frequencies).
- Slide switches should not be used where mispositioning is to be avoided.

10.4.2.7.2 Accidental Actuation

- When accidental actuation needs to be prevented to avoid critical or hazardous conditions, channel guards or equivalent protection should be provided.

10.4.2.7.3 Dimensions, Resistance, and Separation

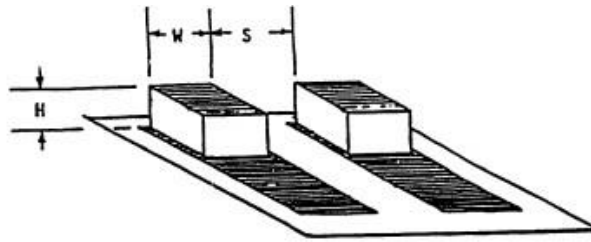
- Dimensions, resistance, and separation of slide switch handles should conform to criteria in Figure 10.4-10.
- Detents should be provided for each control setting.
- Resistance should gradually increase, and then suddenly decrease when the switch snaps into position.
- The switch should not be capable of stopping between positions.

10.4.2.7.4 Orientation

- Slide switches should be vertically oriented with movement of the slide up or away from the operator turning the equipment or component on, causing a quantity to increase, or causing the equipment or component to move forward, clockwise, to the right, or up.
- Horizontally oriented or actuated slide switches should be used only for compatibility with the controlled function or equipment location.

10.4.2.7.5 Positive Indication

- Slide switches with more than two positions must provide positive indication of control setting, preferably a pointer located on the left side of the slide handle.



	DIMENSIONS			RESISTANCE	
	H ACTUATOR HEIGHT		W ACTUATOR WIDTH	SMALL SWITCH	LARGE SWITCH
	*	**			
MINIMUM	6 mm (0.25")	13 mm (0.5")	6 mm (0.25")	2.8 N (10 oz.)	2.8 N (10 oz.)
MAXIMUM	--	--	25 mm (1")	4.5 N (16 oz.)	11 N (40 oz.)

	SEPARATION, S		
	SINGLE FINGER OPERATION	SINGLE FINGER SEQUENTIAL OPERATION	SIMULTANEOUS OPERATION BY DIFFERENT FINGERS
MINIMUM	19 mm (0.75")	13 mm (0.5")	16 mm (0.625")
OPTIMUM	50 mm (2")	25 mm (1")	19mm (0.75")

*Use by bare finger.

** Use with heavy handwear.

Figure 10.4-10 Requirements for slide switches. Source: MIL-STD-1472F.

10.4.2.8 Discrete Push-Pull Controls

10.4.2.8.1 Use

- Push-pull controls may be used when two discrete functions are to be selected. However, such applications should be used sparingly, only for applications in which such configurations are typically expected and in certain cases where limited panel space suggests a miniaturized knob that may be used to serve two related, but distinct, functions (e.g., an ON-OFF / Volume switch for a TV monitor).
- A three-position push-pull control may be used only where inadvertently selecting the wrong position has no serious consequences.

10.4.2.8.2 Handle Dimensions, Displacement, and Clearances

- Push-pull control handles should conform to criteria in Figure 10.4-11.

10.4.2.8.3 Rotation

- Except for combination push-pull / rotate switch configurations (e.g., the handle is rotated to disengage the brake setting), push-pull control handles should be keyed to a non-rotating shaft.
- When the control system provides a combination push-pull / rotate functional operation, using a round-style knob, the rim of the knob should be serrated to denote (visually and tactually) that the knob can be rotated, and to facilitate a slip-free finger grip.

10.4.2.8.4 Detents

- Mechanical detents should be incorporated into push-pull controls to provide tactile indication of positions.

10.4.2.8.5 Snagging and Inadvertent Contact

- Use, location, and operating axis of push-pull type controls should preclude the possibility of the operator's:
 - Bumping a control while getting into or out of position (as in a vehicle),
 - Snagging clothing, communication cables, or other equipment items on the control, or inadvertently deactivating the control setting while reaching for another control.

10.4.2.8.6 Direction of Control Motion

- Control direction should be as follows:
 - Pull toward the operator for ON or activate; push away for OFF or deactivate.
 - Rotate clockwise to activate or increase a function of combination pull / rotary switches.

10.4.2.8.7 Resistance

- Force for pulling a panel control with fingers should be not more than 18 N (4 lb)
- Force for pulling a T-bar with four fingers should be not more than 45 N (10 lb).





CONFIGURATION EXAMPLE	APPLICATION CRITERIA	DESIGN CRITERIA				
		DIMENSIONS			DISPLACEMENT	SEPARATION
	<p>PUSH-PULL CONTROL, LOW RESISTANCE, FOR TWO-POSITION, MECHANICAL AND/OR ELECTRICAL SYSTEMS.</p> <p>ALTERNATE THREE POSITION PLUS ROTARY FUNCTION ACCEPTANCE FOR APPLICATION SUCH AS VEHICLE HEADLIGHT PLUS PARKING LIGHTS, PANEL AND DOME LIGHTS PROVIDE SERRATED RIM.</p>	<u>D, MIN DIAM:</u> 19 mm (0.75")	<u>C, MIN CLEARANCE:</u> 25 mm (1") Add 13 mm (0.5") for gloved hand		25 ±13 mm (1 ±0.5") <u>MIN BETWEEN PULL POSNS:</u> 13 mm (0.5")	<u>S, MIN SPACE BETWEEN:</u> 35 mm (1.5") Add 13 mm (0.5") for gloved hand
	<p>ALTERNATE HANDLE; MINIATURE ELECTRICAL PANEL SWITCH ONLY. AVOID GLOVE USE APPLICATION.</p>	<u>D, MIN DIAM:</u> 6 mm (0.25")	N/A	<u>L, MIN LGTH:</u> 19 mm (0.75")	<u>MINIMUM:</u> 13 mm (0.5")	<u>S, MIN SPACE BETWEEN:</u> 25 mm (1")
	<p>HIGH-FORCE PUSH-PULL, FOR TWO-POSITION MECHANICAL SYSTEM ONLY.</p>	<u>W, MIN WIDTH:</u> 100 mm (4")	<u>D, DEPTH:</u> 16-38 mm (0.625-1.5")	<u>C, MIN CLEARANCE:</u> 38 mm (1.5") Add 6 mm (0.25") for gloved hand	<u>MINIMUM:</u> 25 mm (1") <u>PREFERRED:</u> 50 mm (2")	
	<p>SAME AS ABOVE. PREFERRED WHERE POSSIBLE GARMENT OR CABLE-SNAG POSSIBILITY EXISTS.</p> <p>NOTE: 1 & 2 FINGER PULLS ALSO ACCEPTABLE FOR LESS THAN 18 N (4lb) APPLICATIONS.</p>	<u>W, MIN WIDTH:</u> 100 mm (4") Add 25 mm (1") for gloves	<u>D, DEPTH:</u> 16-32 mm (0.625-1.25")	<u>C, MIN CLEARANCE:</u> 32 mm (1.25")	<u>MINIMUM:</u> 25 mm (1") <u>PREFERRED:</u> 50 mm (2")	<u>S, MIN SPACE BETWEEN:</u> 13 mm (0.5")

Figure 10.4-11 Requirements for push-pull controls. Source: MIL-STD-1472F.

10.4.2.9 Printed Circuit Switch Controls

10.4.2.9.1 Use

A printed-circuit (PC) switch control is a special rotary switch that can be connected directly to a mating printed circuit board without wires.

- PC “DIP”-type switches or hand-selected jumpers should be installed only for settings that require infrequent changes.

10.4.2.9.2 Dimensions, Resistance, Displacement, and Separation

Dimensions, resistance, displacement, and separation between adjacent PC switch actuators should conform to the following:

- Actuators should be sufficiently large to permit error-free manipulation by the operator when using commonly available styluses (e.g., pencil or pen). The actuators should not require the use of a special tool for manipulation.
- Resistance should be sufficiently high to avoid inadvertent actuation under expected use conditions. Resistance should gradually increase, then drop when the actuator snaps into position. The actuator should not be capable of stopping between positions.
- Slide-type actuators should have sufficient travel (displacement) to permit immediate recognition of the switch setting. The travel should be not less than twice the actuator length. When actuators are rocker-type, the actuated wing should be flush with the surface of the module.
- Actuators should have sufficient separation to permit error-free manipulation by the operator (i.e., the stylus cannot inadvertently contact adjacent actuators).

10.4.2.9.3 Shape

- The surface of the actuator should be indented to accept the point of the stylus. The indentation should be sufficiently deep to avoid slippage of the stylus during manipulation.

10.4.2.10 Levers

10.4.2.10.1 Use

A lever is a simple machine consisting of a rigid bar that pivots about a fulcrum. Levers are used to transmit motion and alter mechanical advantage.

- Levers should be used with high force inputs or when multidimensional movements of controls are required.

10.4.2.10.2 Coding

- When several levers are grouped near each other, the lever handles should be coded.

10.4.2.10.3 Limb Support

- When levers are used to make fine or continuous adjustments, support should be provided for the appropriate limb segment as follows:
- For large hand movements: elbow
- For small hand movements: forearm
- For finger movements: wrist

10.4.2.10.4 Dimensions

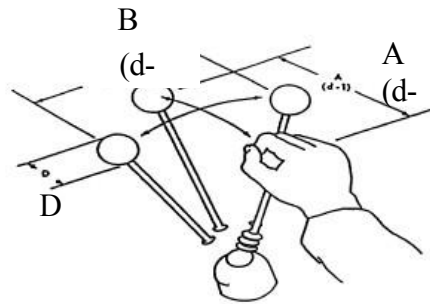
- The length of levers should be determined by the mechanical advantage needed.
- The diameter of spherical lever or grip handles should conform to the criteria in Figure 10.4-12.

10.4.2.10.5 Resistance

- Lever resistance should be within the limits indicated in Figure 10.4-12 measured as linear force applied to a point on the handle.

10.4.2.10.6 Displacement and Separation

- Control displacement (for the seated operator) and separation should conform to the criteria in Figure 10.4-12.



	DIAMETER		RESISTANCE			
	Finger Grasp	Hand Grasp	(d-1)		(d-2)	
			One Hand	Two Hands	One Hand	Two Hands
Minimum	13 mm (0.5 in.)	38 mm (1.5 in.)	9 N (2 lb)	9 N (2 lb)	9 N (2 lb)	9 N (2 lb)
Maximum	38 mm (1.5 in.)	75 mm (3 in.)	135 N (30 lb)	220 N (50 lb)	90 N (20 lb)	135 N (30 lb)
	DISPLACEMENT		SEPARATION			
	Forward (d-1)	Lateral (d-2)	One Hand Random		Two Hands Simultaneously	
Minimum	-	-	50 mm (2 in.)		75 mm (3 in.)	
Preferred			100 mm (4 in.)		125 mm (5 in.)	
Maximum	360 mm (14 in.)	970 mm (38 in.)				

Figure 10.4-12 Requirements for levers. Source: MIL-STD-1472F.

10.4.2.11 Displacement (Isotonic) Joysticks

A joystick is a general control device consisting of a handheld stick that pivots about one end and transmits its angle in two or three directions to a computer. Displacement joysticks have the following uses:

- Joysticks may be used when the task requires precise or continuous control in two or more related dimensions.
- Displacement joysticks may also be used for various display functions such as selecting data from a display and generation of free-drawn graphics.
- When positioning accuracy is more critical than positioning speed, displacement joysticks should be selected over isometric joysticks. Displacement joysticks usually require less force than isometric joysticks and are less fatiguing for long operating periods.

Consider the following general operating characteristics when designing displacement joysticks:

- In rate-control applications, which allow the follower (cursor or tracking symbol) to transit beyond the edge of the display, indicators should be provided to aid the operator in bringing the follower back onto the display.
- For displacement joysticks used for rate control, resistance to movement should increase with the distance the user displaces it from the center (null) position) and the control should return to the center when the hand is removed.
- Displacement joysticks that have a deadband near the center or hysteresis should not be used with automatic sequencing of a display follower (cursor or tracking symbol) unless they are instrumented for null return or zero-set to the instantaneous position of the stick at the time of sequencing. Upon termination of the automatic sequencing routine, the joystick center should again be registered to scope center.

Following is a discussion of three types of displacement joysticks, distinguished by how the operator uses them: Hand-operated displacement joysticks, Finger-operated displacement joystick, and Thumbtip/fingertip-operated displacement joysticks.

10.4.2.12 Hand-Operated Displacement Joysticks

10.4.2.12.1 Use

- Hand-operated displacement joysticks may be used to control vehicles and aim sensors.
- Such joysticks may be used as mounting platforms for secondary controls, such as thumb-and finger-operated switches. (Operation of secondary controls has less induced error on a displacement hand grip than on an isometric handgrip.)
- When buttons are located on hand-operated joysticks, they should be operable using a normal grip without diminishing control of the joystick.

10.4.2.12.2 Dynamic Characteristics

- Movement should not exceed 45° from the center position and should be smooth in all directions.
- Positioning of a follower should be attainable without noticeable backlash, cross-coupling, or need for multiple corrective movements.
- Control ratios, friction, and inertia should meet the dual requirements of rapid gross positioning and precise fine positioning.
- When a joystick is used for free motion, the display refresh rate should be sufficiently high to display the follower as a continuous track.
- Delay between control movement and the confirming display response should be minimized and should be not greater than 0.1 second.

10.4.2.12.3 Dimensions and Clearance

- The hand-grip length should be 110 to 180 mm (4.3 – 7.1 in.).
- The grip diameter should be not more than 50 mm (2 in.). Clearances of 100 mm (4 in.) to the side and 50 mm (2 in.) to the rear should be provided to allow for hand movement.
- Joysticks should be mounted to provide forearm support.
- Modular devices should be mounted to allow actuation of the joystick without slippage, movement, or tilting of the mounting base.

10.4.2.13 Finger-Operated Displacement Joysticks

10.4.2.13.1 Use

- Finger-operated displacement joysticks are useful for free motion. In this application, there is usually no spring return to center, and the resistance should be sufficient to maintain the handle position when the hand is removed.

10.4.2.13.2 Dynamic Characteristics

- Dynamic characteristics should conform to 10.6.3.11.2.2. Recessed mounting may be used as indicated in Figure 10.4-13, to allow more precise control.

10.4.2.13.3 Dimensions, Resistance, and Clearance

- The joystick should be mounted on a desk or shelf surface as shown in Figure 10.4-13. Joysticks should be mounted to provide forearm or wrist support. Modular devices should be mounted to allow actuation of the joystick without slippage, movement, or tilting of the mounting base.

10.4.2.14 Thumbtip- / Fingertip-Operated Displacement Joysticks

10.4.2.14.1 Use

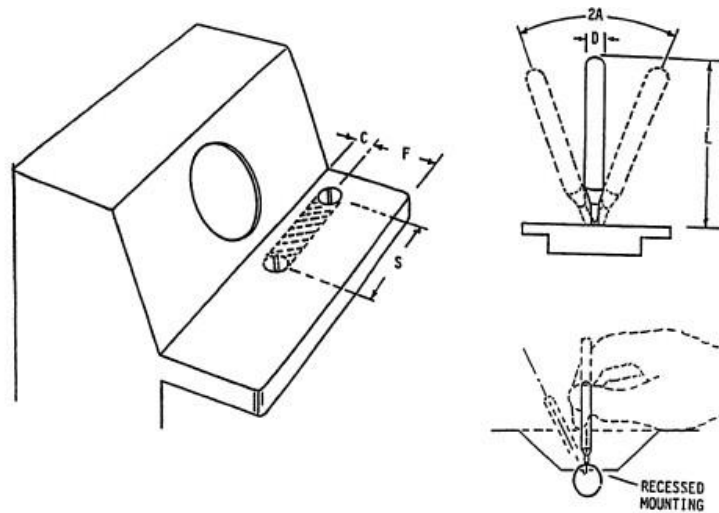
- Thumbtip- / fingertip-operated joysticks may be mounted on a hand grip, which serves as a steady rest to damp vibrations and increase precision.
- If a joystick is mounted on a hand grip, the hand grip should not simultaneously function as a joystick controller.

10.4.2.14.2 Dynamic Characteristics

- Movement should not exceed 45° from the center position.

10.4.2.14.3 Dimensions, Resistance, and Clearance

- Joysticks should be mounted to provide wrist or hand support. Console-mounted devices should be mounted as shown in Figure 10.4-13.
- Modular devices should be mounted to allow actuation of the joystick without slippage, movement, or tilting of the mounting base.



	DIMENSIONS		RESISTANCE	DISPLACEMENT A	CLEARANCE		
	D DIAM	L LENGTH			S DISPLAY CL TO STICK CL	C AROUND STICK	F STICK CL. TO SHELF FRONT
MINIMUM	6.5 mm (0.25")	75 mm (3")	3.3 N (12 oz.)		0	*	120 mm (4.75")
MAXIMUM	16 mm (0.625")	150 mm (6")	8.9 N (32 oz.)	$\frac{\pi}{4}$ rad (45°)	400 mm (15.75")		250 mm (10")

*Maximum stick excursion plus 100 mm (4").

Figure 10.4-13 Requirements for displacement (isotonic) joysticks. Source: MIL-STD-1472F.

10.4.2.15 Isometric Joystick (Two-Axis Controller)

The isometric joystick is also known as the stiff stick, force stick, or pressure stick. The control has no perceptible movement, but its output is a function of the force applied.

- Isometric joysticks may be used for tasks requiring precise or continuous control in two or more related dimensions and are particularly appropriate for the following types of application:
 - Applications that require precise return to center after each use
 - Applications in which operator feedback is primarily visual, rather than tactile feedback from the control itself
 - Applications where there is minimal delay and tight coupling between control input and system reaction
- When positioning speed is more critical than positioning accuracy, isometric joysticks should be selected over displacement joysticks.

- Isometric joysticks may be used for various display functions such as data pickoff from a display.
- Isometric sticks should not be used in applications that require the operator to maintain a constant force on the control for a long period or that provide no definitive feedback when maximum control inputs have been exceeded.
- In rate-control applications, which may allow the follower (cursor or tracking symbol) to transit beyond the edge of the display, indicators should be provided to aid the operator in bringing the follower back onto the display.

Following is a discussion of three types of isometric joysticks, distinguished by how the operator uses them: Hand-operated isometric joysticks, Finger-operated isometric joysticks, and Thumbtip- / fingertip-operated isometric joysticks.

10.4.2.16 Hand-Operated Isometric Joysticks

10.4.2.16.1 Use

- Hand-operated isometric joysticks may be used as vehicle controllers, aiming sensors, and mounting platforms for secondary controls, such as thumb- and finger-operated switches. (Operation of secondary controls has greater induced error on the isometric hand grip than does operation of displacement hand-grip joysticks.)

10.4.2.16.2 Dynamic Characteristics

- Maximum force for full output should be not more than 118 N (26.7 lb).

10.4.2.16.3 Dimensions, Resistance, and Clearance

- Dimensions, resistance, and clearance should conform to the specifications listed in section 10.4.2.12.3.

10.4.2.17 Finger-Operated

- Dimensions, resistance, and clearance should conform to the specifications listed in section 10.4.2.13.3.

10.4.2.18 Thumbtip- / Fingertip-Operated Isometric Joysticks

10.4.2.18.1 Use

- Thumbtip- / fingertip-operated joysticks may be mounted on a hand grip, which serves as a steady rest to damp vibrations or increase precision.
- If the joystick is so mounted, the hand grip should not simultaneously function as a joystick controller.

10.4.2.18.2 Dimensions, Resistance, and Clearance

- Dimensions, resistance, and clearance should conform to the specifications listed in section 10.4.2.14.3.

10.4.2.18.3 Ball Control

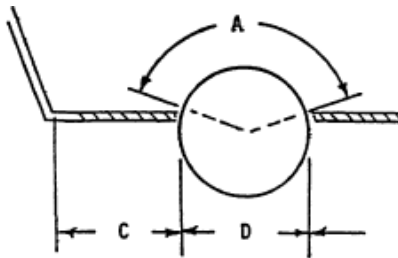
A trackball is a pointing device consisting of a ball housed in a socket containing sensors to detect rotations of the ball about two axes.

- Studies in 0g have shown that trackballs can be used efficiently in space. They are unaffected by 0g if properly designed and mounted.

Using a trackball requires more training and practice than using a mouse, but the speed and accuracy of the trackball are comparable to those of the mouse. Because a type of rolling movement is necessary for actuation, repetitive strain injuries may be avoided. Trackballs can be easily built into consoles.

10.4.2.18.4 Dimensions and Resistance

Dimensions and resistance should conform to the criteria listed in Figure 10.4-15.



	DIMENSIONS		RESISTANCE	
	D DIAM	A SURFACE EXPOSURE	PRECISION REQUIRED	VIBRATION OR ACCEL CONDITIONS
MINIMUM	50 mm (2.0")	100°	0.25 N (0.9 oz)	—
PREFERRED	100 mm (4.0")	120°	0.3 N (1.1 oz)	—
MAXIMUM	150 mm (6.0")	140°	1.5 N (5.4 oz)	1.7 N (6.0 oz)

NOTE: Initial resistance should range from 0.25 N(0.9 oz) to 0.4 N (1.4 oz). 1.0

Figure 10.4-15 Requirements for ball controls. Source: MIL-STD-1472F and HFES (2007)

10.4.2.19 Stylus

- A stylus is similar in form and use to writing tools, and because of this similarity it is excellent for graphic entry, but requires extra space on the work surface.

Displacement of visual feedback from motor activity may cause coordination problems. Entering hand-printed characters to be recognized by the system is very slow (fewer than 40 characters /

min) compared with type entry (averaging 200 recognition characters/min). It is difficult to maintain control in 0g.

10.4.2.19.1 Force

- The stylus force required on a tablet to produce a continuous input should be not greater than 0.8 N (2.9 oz).

10.4.2.19.2 Design

- The stylus should have a slip-resistant grip surface. Figure 10.4-16 shows the recommended stylus dimensions.

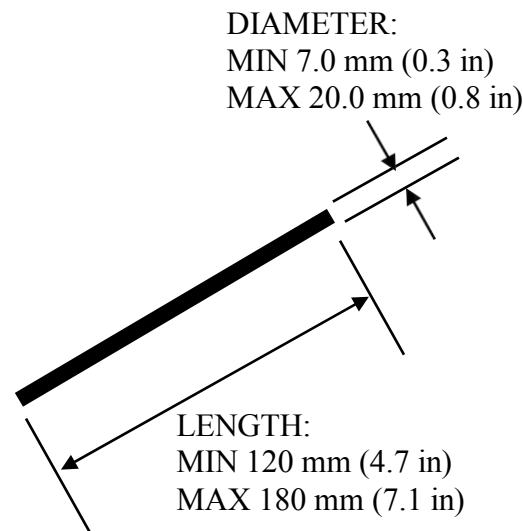


Figure 10.4-16 Requirements for styluses. Source: MIL-STD-1472F and HFES (2007)

10.4.2.20 Mouse

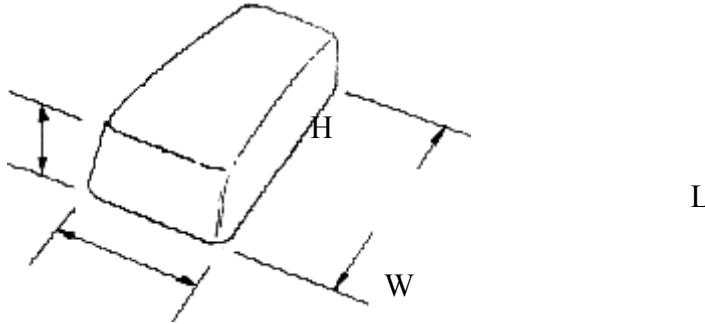
A mouse is the most common input device for interacting with objects on interfaces. It detects 2D motion relative to its supporting surface.

- A mouse should be used when fast performance and low error rates are desired; however, a mouse may not be the best choice for 0g because it typically requires a flat work surface.

Positioning is important, because when a mouse is held backward or sideways, it does not work in the intended way. Since the computer mouse is widely used for many applications, its use is intuitive and little training is needed. Human factors considerations: ergonomic design, hand fatigue, repetitive strain injury.

10.4.2.20.1 Dimensions

- Figure 10.4-17 shows recommended dimensions for the mouse. These recommendations also apply to puck devices.



	WIDTH (W)	LENGTH (L)	HEIGHT (H)
MIN	40 mm (1.6 in)	70 mm (2.8 in)	25 mm (1.0 in)
MAX	70 mm (2.8 in)	120 mm (4.7 in)	40 mm (1.6 in)

Figure 10.4-17 Recommended dimensions for mouse interfaces. Source: MIL-STD-1472F and HFES (2007)

10.4.2.20.2 Mouse Position Sensor

- Fine positioning accuracy is improved if the sensor for mouse position is forward on the mouse, under the fingertips rather than under the palm of the hand.

10.4.2.21 Touch Screen

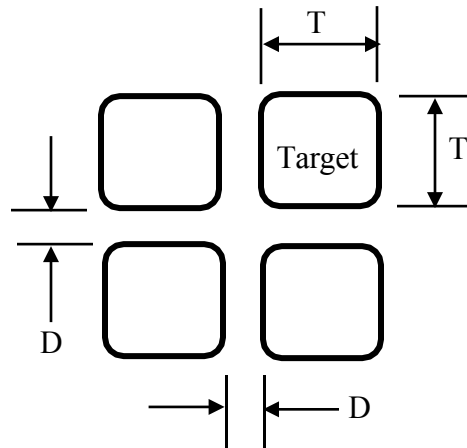
Touch screens are displays that can detect touches within the display area. Touch screens are direct input devices because the input is in direct correspondence with the targets. They are very popular because they are intuitive to use. Their sensitivity can be changed according to their role, but the sensitivity can be reduced by impurities. An ergonomic problem is the stress on fingers (and possibly the arm) that occurs when a touch screen is used for more than a few minutes at a time.

- Touchscreens should be used whenever an intuitive direct method of input is desired, but should not be used for applications requiring inputs of extended duration.

10.4.2.21.1 Dimensions

- If the user must touch a specific area on the screen, then this area must be of sufficient size to minimize errors. Accuracy is not improved, however, beyond a certain maximum size.
- Each area should be surrounded by a dead space to minimize accidental activation of an adjacent touch area.

Figure 10.4-18 gives recommended touch area and dead space sizes.



	TARGET HEIGHT AND WIDTH (T)	DEAD SPACE BETWEEN TARGETS (D)
MIN	9.5 mm (0.4 in)	3.2 mm (0.1 in)
MAX (ineffective beyond this size)	22 mm (0.9 in)	--

Figure 10.4-18 Recommended dimensions for touch screen areas. Source: MIL-STD-1472F and HFES (2007)

10.4.2.22 Pedals

- Pedal controls should be used only where the operator is likely to have both hands occupied, control system force is too high for the manual force capability of the operator, or standardized use of pedals has created a stereotype expectancy (e.g., vehicle pedal controls such as clutches, brakes, accelerators, and rudders).

10.4.2.22.1 Location

- Pedal controls should be located so that the operator can reach them easily without extreme stretching or twisting and can reach the maximally-displaced pedals within anthropometric limits and force capabilities (see Figure 10.10-16).
- Pedals that may be held or must be adjusted (e.g., accelerator, clutch) should be located so the operator can “rest” and “steady” the foot, i.e., the pedal should be an appropriate critical distance above the floor so the operator’s heel can rest on the floor while articulating the ankle and foot. When this cannot be done and the pedal angle is more than 20° from the horizontal floor, a heel rest should be provided.

10.4.2.22.2 Pedal Return

- Except for controls that generate a continuous output (e.g., rudder controls), pedals should return to the original null position without requiring assistance from the operator (e.g., brake pedal).

- Where the operator's foot may normally rest on the pedal between operations, sufficient resistance should be provided to prevent the weight of the foot from inadvertently actuating the control (e.g., accelerator pedal).

10.4.2.22.3 Pedal Travel

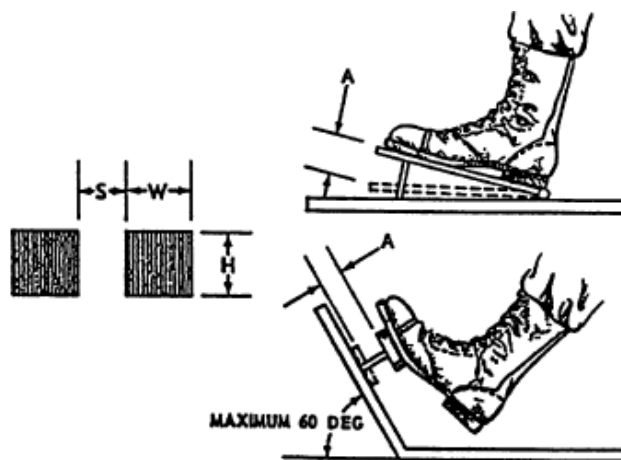
- The travel path should be compatible with the natural articulation path of the operator's limbs (i.e., thigh, knee, ankle).

10.4.2.22.4 Nonslip Pedal Surface

- Pedals should have a nonskid surface. This is especially true of pedals with high force requirements.

10.4.2.22.5 Dimensions, Resistance, Displacement, and Separation

- Dimensions, resistance, displacement, and separation of pedals should conform to the criteria in Figure 10.4-19.



	DIMENSIONS		DISPLACEMENT			
	H Height	W Width	Normal Operation	Heavy Boots	Ankle Flexion	Total Leg Movement
Minimum	25 mm (1 in.)	75 mm (3 in.)	13 mm (0.5 in.)	25 mm (1 in.)	25 mm (1 in.)	25 mm (1 in.)
Maximum			65 mm (2.5 in.)	65 mm (2.5 in.)	65 mm (2.5 in.)	180 mm (7 in.)
	RESISTANCE					
	Foot Not Resting on Pedal		Foot Resting On Pedal	Ankle Flexion Only	Total Leg Movement	
Minimum	18 N (4 lb)		45 N (10 lb)	-	45 N (10 lb)	
Maximum	90 N (20 lb)		90 N (20 lb)	45 N (10 lb)	800 N (180 lb)	
	SEPARATION					
	S			A		
	One Foot Random			One Foot Sequential		
Minimum	100 mm (4 in.)			50 mm (2 in.)		
Preferred	150 mm (6 in.)			100 mm (4 in.)		

Figure 10.4-19 Requirements for pedals. Source: MIL-STD-1472F

10.4.2.23 Rotary Selector Switches

10.4.2.23.1 Use

- Rotary selector switches (see Figure 10.4-20) should be used for discrete functions when three or more detented positions are required.
- A rotary selector switch should not be used for a two-position function unless prompt visual identification of the control position is of primary importance and speed of control operation is not critical.

10.4.2.23.2 Moving Pointer

- A rotary selector switch should be designed with a moving pointer and a fixed scale.

10.4.2.23.3 Shape

- A moving pointer knob should be bar-shaped with parallel sides and its index end tapered to a point. Exceptions may be made when pointer knobs are shape coded or when space is restricted and torque is light.
- Shape coding should be used when a group of rotary controls, used for different functions, is placed on the same panel and control confusion might otherwise result.

10.4.2.23.4 Positions

- A rotary selector switch that is not visible to the operator during normal system operation should have no more than 12 positions.
- A rotary switch that is constantly visible to the operator should have not more than 24 positions.
- Rotary switch positions should not be placed opposite each other unless knob shape prevents confusion about which end of the knob is the pointer.
- Switch resistance should be elastic, build up, then decrease as each position is approached, so that the control snaps into position without stopping between adjacent positions.

10.4.2.23.5 Contrast

- A reference line should be provided on rotary switch controls. The luminance contrast of this line with the control color should be not less than 3.0 under all lighting conditions.

10.4.2.23.6 Parallax

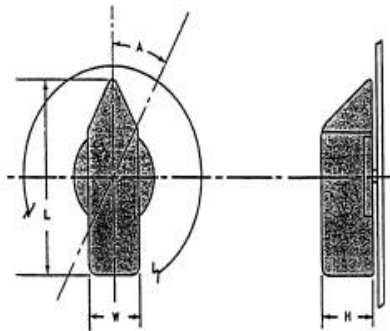
- The knob pointer should be mounted close enough to its scale to minimize parallax between the pointer and the scale markings.
- When viewed from the normal operator's position, the parallax errors should not exceed 25% of the distance between scale markings.

10.4.2.23.7 Attachment

- Selector switch shafts and knobs should be designed for only the intended installation orientation.

10.4.2.24 Control Dimensions, Resistance, Displacement, and Separation

- Control dimensions, resistance, displacement, and separation between adjacent edges of areas swept by rotary selector switches should conform to the criteria in Figure 10.4-20.



	DIMENSIONS			RESISTANCE
	L Length	W Width	H Depth	
Minimum	25 mm (1 in.)	25 mm (1 in.)	16 mm (0.625 in.)	115 mN · m (1 in. -lb)
Maximum	100 mm (4 in.)		75 mm (3 in.)	680 mN · m (6 in. -lb)
	DISPLACEMENT		SEPARATION	
	A		One-Hand Random	Two-Handed Operation
Minimum	262 mrad (15°)	525 mrad (30°)	25 mm (1 in.)	75 mm (3 in.)
Maximum	700 mrad (40°)	1570 mrad (90°)	•	•
Preferred	•	•	50 mm (2 in.)	125 mm (5 in.)

* For facilitating performance

** When special engineering requirements demand large separation or when tactually ("blind") positioned controls are required.

Figure 10.4-20 Requirements for rotary selector switches. Source: MIL-STD-1472F

10.4.2.25 Discrete Thumbwheel Controls

10.4.2.25.1 Use

- Thumbwheel controls may be used if the function requires a compact digital control-input device (for a series of numbers) and a readout of these manual inputs for verification. The use of thumbwheels for any other purpose is discouraged.
- Detent indexing units should provide 10 positions (0 – 9) in digital or binary (3 or 4 bits and complement) outputs.
- Thumbwheels can be discrete- or continuous-position thumbwheels. Discrete-position thumbwheels should have 10 or fewer detent positions.
- Each position around the circumference of a discrete thumbwheel should have a slightly concave surface to ensure easy positioning.
- Resistance should be elastic, building up and then decreasing as each detent is approached so that the control snaps into position without stopping between adjacent detents. These movement characteristics make sure that operation is easy and the user receives enough tactile feedback.

- For continuous-position thumbwheels, hard stops should be provided to limit the maximum amount of travel.

10.4.2.25.2 Shape

- Each position around the circumference of a discrete thumbwheel should have a concave surface or should be separated by a high-friction area that is raised from the periphery of the thumbwheel.
- The thumbwheels should not preclude viewing the digits within a 30° viewing angle to the left and right of a perpendicular to the thumbwheel digits.

10.4.2.25.3 Coding

Thumbwheel controls may be coded by location, labeling, and color (e.g., reversing the colors of the least significant digit wheel as on typical odometers).

- Where used as input devices, thumbwheel switch Off or Normal positions should be color coded to permit a visual check that the digits have been reset to their Off or Normal positions.

10.4.2.25.4 Direction of Movement

- Moving the thumbwheel edge forward, upward, or to the right should increase the setting.

10.4.2.25.5 Numerals

- Where ambient illumination will provide display brightness below 3.5 cd/m² (1 ft-L), the thumbwheel characters should be internally illuminated and appear against a black background.

10.4.2.25.6 Visibility

- Thumbwheel design should permit viewing of inline digital readout from all operator positions.

10.4.2.25.7 Dimensions

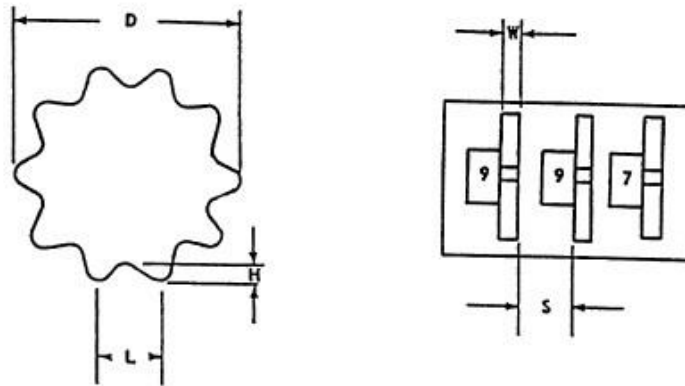
- Control dimensions should conform to the criteria in Figure 10.4-21.

10.4.2.25.8 Resistance

- Detents should be provided for discrete position thumbwheels.
- Resistance should be elastic, and should build up and then decrease as each detent is approached so that the control snaps into position without stopping between adjacent detents.
- The resistance should be within the limits indicated in Figure 10.4-21.

10.4.2.25.9 Separation

- The separation between adjacent edges of thumbwheel controls should conform to the criteria in Figure 10.4-21 and should be sufficient to preclude accidental actuation of adjacent controls during normal setting of the thumbwheel.



	D DIAMETER	L TROUGH DISTANCE	W WIDTH	H DEPTH	S SEPARATION	RESISTANCE
MINIMUM	29 mm (1.125 in)	11 mm (0.43 in)	3 mm (0.125 in)	3 mm (0.125 in)	10 mm (0.4 in)	1.7 N (6 oz)
MAXIMUM	75 mm (3 in)	19 mm (0.75 in)		6 mm (0.25 in)		5.6 N (20 oz)

Figure 10.4-21 Requirements for discrete thumbwheel controls. Source: MIL-STD-1472F.

10.4.2.26 Continuous-Adjustment Thumbwheel Controls

10.4.2.26.1 Use

Continuously adjustable thumbwheel controls may be used as an alternative to rotary knobs when the application will benefit from the compactness of the thumbwheel device.

10.4.2.26.2 Orientation and Movement

- Thumbwheels should be oriented and move in the directions specified in Figure 10.4-22.
- If a thumbwheel is used to affect vehicle motion, movement of the thumbwheel forward or up should cause the vehicle to forward or up.

10.4.2.26.3 Turning Aids

- The rim of a thumbwheel should be serrated or provided with a high-friction surface to aid the operator in manipulating the control.

10.4.2.26.4 Dimensions, Separation, and Resistance

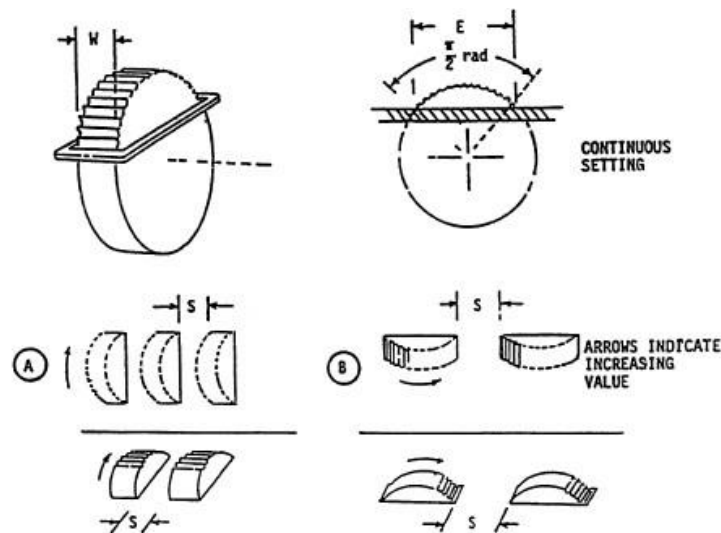
- Dimensions, separation, and resistance should conform to criteria in Figure 10.4-22.

10.4.2.26.5 Labeling and Visibility

- Marking and labeling should conform to requirements herein, with respect to visibility of markings and legibility of label alphanumeric.

10.4.2.26.6 OFF Position

- A detent should be provided for continuous thumbwheels having an OFF position.



	E RIM EXPOSURE	W WIDTH	S		RESISTANCE
			Ⓐ	Ⓑ	
MINIMUM	25 mm * (1")	3 mm * (0.125")	25 mm (1") Add 13 mm (1/2") for gloves	50 mm (2") Add 25 mm (1") for gloves	TO MINIMIZE EFFECTS OF INADVERTENT INPUT IF OPERATOR SUBJECT TO MOTION
MAXIMUM	100 mm (4")	23 mm (0.875")	N/A	N/A	3.3 N (12 oz.)

* Preferred. Some miniature applications may require less.

Figure 10.4-22 Requirements for continuous-adjustment thumbwheels. Source: MILSTD-1472F.

10.4.2.27 Knobs

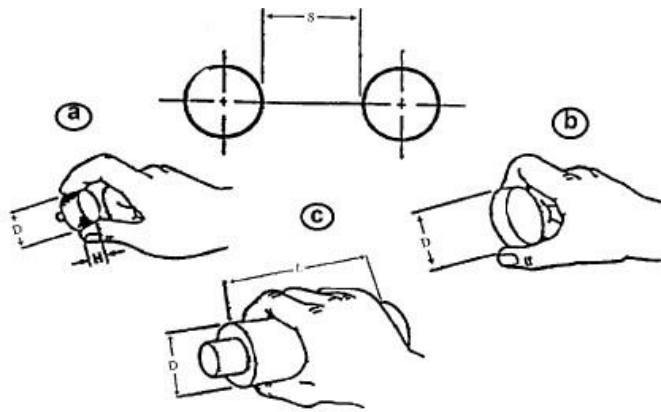
10.4.2.27.1 Use

- Knobs should be used when low forces or precise adjustments of a continuous variable are required.

- For most tasks, a moving knob with fixed scale is preferred over a moving scale with fixed index.
- If positions of single-revolution controls must be distinguished, a pointer or marker should be available on the knob.

10.4.2.27.2 Dimensions, Torque, and Separation

- The dimensions of knobs should be within the limits specified in Figure 10.4-23.
- The knob should be easily grasped and manipulated.
- When panel space is extremely limited, knobs should be as small as possible while maintaining good usability and should have resistance as low as possible without permitting the setting to be changed via vibration or merely touching the control.
- Resistance and separation between adjacent edges of knobs should conform to Figure 10.4-23.



DIMENSIONS						
	(a) Fingertip Grasp		(b) Thumb and Finger Encircled		(c) Palm Grasp	
	H Height	D Diameter	H Height	D Diameter	D Diameter	L Length
Minimum	13 mm (0.5 in.)	10 mm (0.4 in.)	13 mm (0.5 in.)	25 mm (1.0 in.)	38 mm (1.5 in.)	75 mm (3.0 in.)
Maximum	25 mm (1.0 in.)	100 mm (4.0 in.)	25 mm (1.0 in.)	75 mm (3.0 in.)	75 mm (3.0 in.)	-

	TORQUE		SEPARATION	
	*	**	S One Hand Individually	S Two Hands Simultaneously
Minimum	-	-	25 mm (1.0 in.)	50 mm (2.0 in.)
Optimum	-	-	50 mm (2.0 in.)	125 mm (5 in.)
Maximum	32 mN·m (4.5 in. -oz)	42 mN·m (6.0 in. -oz)	-	-

* = 25 mm (1.0 in) diameter knobs

** > 25 mm (1.0 in) diameter knobs.

Figure 10.4-23 Requirements for knobs. Source: MIL-STD-1472F

10.4.2.28 Cranks

10.4.2.28.1 Use

A crank is a device or mechanism for producing rotation about an axis. Its usual form is a bar or disk set at right angles to the shaft and containing a crank-pin, remote from the axis of rotation, to which the force is applied.

- Cranks should be used for tasks that require many rotations of a control, particularly where high rates or large forces are involved. For tasks that involve large slewing movements, plus small, fine adjustments, a crank handle may be mounted on a knob or handwheel.
- Where cranks are used for tuning, or other processes involving numerical selection, each rotation should correspond to a multiple of 1, 10, 100, etc.
- Simultaneously operated hand cranks should be used in preference to other two-axis controllers where extreme precision is required in setting crosshairs, or reticles as in map readouts or optical sighting mechanisms (as opposed to tracking).
- This type of control may also be used in other applications requiring x-y control, provided there is no requirement for rapid or frequent operation. The gear ratio and dynamic characteristics of such cranks should allow precise placement of the follower (e.g., crosshairs) without overshooting or undershooting or requiring successive corrective movements.

10.4.2.28.2 Grip Handle

- The crank grip handle should be designed so that it turns freely around its shaft.

10.4.2.28.3 Dimensions, Resistance, and Separation

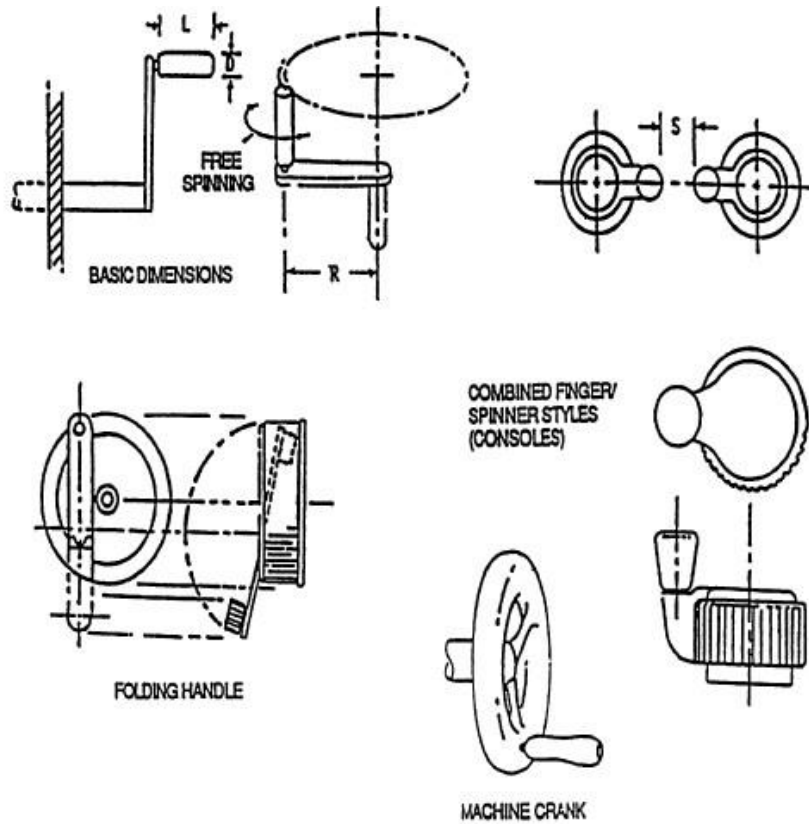
- Dimensions, resistance, and separation between adjacent circular areas of cranks should conform to the criteria of Figure 10.4-24.

10.4.2.28.4 Location

- Cranks that are to be operated from a standing position should be mounted between 900 and 1200 mm (35 – 47 in.) above the floor.

10.4.2.28.5 Folding Handle

- If a crank handle could become a hazard to persons passing by, or if it is critical that the handle not be inadvertently displaced by being accidentally bumped, a folding handle-type control should be used. Such a handle should be spring-loaded to keep it extended in the cranking position when in use and folded when not in use.



LOAD	DIMENSION	HANDLE		R. TURNING RADIUS	
		L, LENGTH	D, DIAMETER	RATE BELOW 100 RPM	RATE ABOVE 100 RPM
LIGHT LOADS <22 N (5 lb): Wrist & finger movement	MINIMUM	25 mm (1.0 in.)	10 mm (0.4 in.)	38 mm (1.5 in.)	13 mm (0.5 in.)
	PREFERRED	38 mm (1.5 in.)	13 mm (0.5 in.)	75 mm (3.0 in.)	65 mm (2.5 in.)
	MAXIMUM	75 mm (3.0 in.)	16 mm (0.625)	125 mm (5.0 in.)	115 mm (4.5 in.)
HEAVY LOADS >22 N (5 lb): Arm movement	MINIMUM	75 mm (3.0 in.)	25 mm (1.0 in.)	190 mm (7.5 in.)	125 mm (5.0 in.)
	PREFERRED	95 mm (3.75 in.)	25 mm (1.0 in.)	—	—
	MAXIMUM	—	38 mm (1.5 in.)	510 mm (20 in.)	230 mm (9.0 in.)

S, Separation between adjacent controls: 75 mm (3"), minimum.

Figure 10.4-24 Requirements for cranks. Source: MIL-STD-1472F.

10.4.2.29 Hand Wheels (Two-Hand Operated)

10.4.2.29.1 Use

A hand wheel is a small wheel fitted to the hand for operating such mechanisms as valves.

- Hand wheels, designed for nominal two-hand operation, should be used when the breakout or rotational forces are too high to be easily overcome with a one-handed control, provided that two hands are available for this task.

Typical applications are steering, latch securing, valve opening and closing, and direct-linkage adjustment.

- Hand wheels should be used where there is substantial space, and are not good for fine adjustments.
- When a hand wheel is designed for use in 0g, adequate restraints should be provided for the operator.

10.4.2.29.2 Turning Aids

- Knurling, indenting, high-friction covering, or a combination of these should be built into the handwheel to facilitate operator grasp for applying maximum torque and to reduce the possibility of the wheel's being jerked from the operator's hands.

10.4.2.29.3 Spinner Handles

For applications where the wheel may be rotated rapidly through several revolutions, a spinner handle may be added, except where it is vulnerable to inadvertent displacement of a critical wheel setting or if it creates a safety hazard.

10.4.2.29.4 Direction of Movement

- Except for valves, handwheels should rotate clockwise for ON or INCREASE and counterclockwise for OFF or DECREASE.
- The direction of motion should be indicated on the handwheel or immediately adjacent to it, by means of an arrow and appropriate legends.

10.4.2.29.5 Dimensions, Resistance, Displacement, and Separation

- Control dimensions, resistance, displacement, and separation between edges of adjacent handwheels should conform to the criteria in Figure 10.4-25a and 10.4-25b.

10.4.2.29.6 Steering Wheel Shape

- All steering wheels should be round, except for established uses and where maximum wheel deflection does not exceed 120°.

10.4.2.29.7 Power Steering Failure

- Steering systems should provide sufficient mechanical advantage to meet the force requirements of Figure 10.4-25, even when the primary operating mode is power assisted (i.e., the operator should be able to steer the vehicle to a safe stop if power fails).

10.4.2.29.8 Steering Ratio

- Maximum turning limits of vehicles should be achieved with not more than 3.5 turns of the steering wheel.

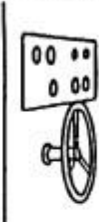
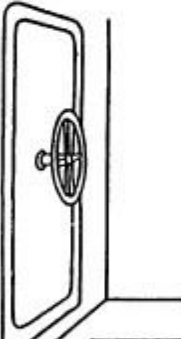
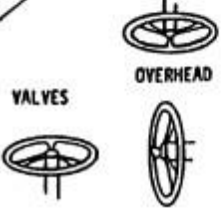
CONFIGURATION EXAMPLE	APPLICATION CRITERIA	DESIGN CRITERIA				
		DIMENSIONS			DISPLACEMENT	SEPARATION
		DIAMETER	RIM DIAM	MIN HAND CLEARANCE		
	CONTINUOUS ADJUSTMENT FOR ALTERNATE SLEWING/PRECISE POSITIONING, USING DISPLAY REFERENCE. RESISTANCE LOW (e.g., BELOW 110 N (25 lb))	200-510 mm (8-20")	19-32 mm (0.75-1.125")	75 mm (3") around rim	See control/display ratios 5.1.4	710 mm (28") elbow-elbow clearance
	CONTINUOUS LOCK-UNLOCK OPERATION	200 mm (8") for 22 N (5 lb) to 510 mm (20") for 155 N (35 lb)	19-32 mm (0.75-1.125")	75 mm (3") around rim	N/A	710 mm (28") elbow-elbow clearance
	HIGH TORQUE VALVES	200-400 mm (8-16") for overhead; 200-510 mm (8-20") for other positions; 300-1520 mm (12-60") abv standing surface	19-32 mm (0.75-1.125")	75 mm (3") around rim	See 5.1.4 when applicable	710 mm (28") elbow-elbow clearance 100 - 150 mm (4.0 - 6.0 in) overhead valve rim-to-rim clearance

Figure 10.4-25a Requirements for handwheels (page 1 of 2). Source: MIL-STD-1472F

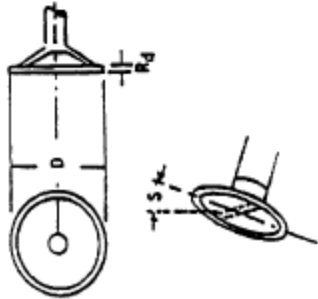
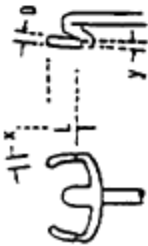
CONFIGURATION EXAMPLE	APPLICATION CRITERIA	DESIGN CRITERIA				SEPARATION
		DIMENSIONS		DISPLACEMENT	SLOPE	
		D, DIAMETER	R _d , RIM DIAM			
	VEHICLES STEERING (AUTOMOTIVE) MAX RESISTANCE POWER STEERING MAX NON-POWER = 220 N (50 lb)	355-400 mm (14-16") for pwr steering 400-510 mm (16-20") for non- pwr steering	19-32 mm (0.75-1.125")	525 mrad (30°) for light vehicle (preferred) 785 mrad (45°) for heavy vehicle (preferred)	Max of $\pm 2/3 \pi$ rad (120°) when both hands must remain on wheel	N/A
	AIRCRAFT STEERING (COMBINE WITH LEVER FOR PITCH, RUDDER PEDALS FOR ROLL/STEER)	32 mm (1.125") preferred	L, GRIP LGTH	X-Y GRIP TIL	± 525 mrad (30°) max preferred	N/A

Figure 10.4-25b Requirements for handwheels (page 2 of 2). Source: MIL-STD-1472F

10.4.2.30 Other Controls

The following is a brief discussion of newer and/or less common controls. Generally, these controls are computer input devices.

10.4.2.30.1 Freespace controller

A freespace controller is an input device that detects the user's movement of the device in free space. These manipulations are then typically translated into control inputs for some interactive system, such as a personal computer, television, or game console. Many of these fall into the category of pointing devices, and eliminate the need for a computer mouse or trackball in situations where these devices are difficult to deploy or use. Freespace controller devices are typically handheld, although devices designed for accessibility can be mounted on other mobile parts of the body, such as the head.

10.4.2.30.2 3D controller

Motion controllers feature a ball, or cap, which easily rotates in 6 directions to perform the ultimate in 3D navigation. It can simultaneously pan, zoom, and rotate models and objects on the screen, without using the mouse. It allows perfect and precise positioning in one fluid motion. These controllers also have programmable buttons that allow the user to map frequently used commands and functions for one-touch access. They also make it possible to quickly execute a command sequence that would take many trips to the keyboard or many clicks on the menu bar to accomplish.

Roller bar: The roller bar moves the cursor by sliding left to right, up and down, and diagonally. It is positioned below the keyboard in the center, allowing easy access when hands are on the keyboard. Pressing the roller bar is a single click. It also has an additional button that makes it similar to a traditional mouse. It addresses some ergonomic problems of the mouse; for example, it does not require lifting the arm to reach out.

10.4.2.30.3 Voice activation

Voice activation is the activation of a command by using the voice. It does not require hands nor gaze shift from the user. It can be useful in no-light or low-light conditions. Voice activation allows simultaneous activation of more than one control mode. A speaker-dependent system prevents an unauthorized person from issuing commands verbally. The disadvantages of voice activation include the following: data entry can be slow, a specified vocabulary must be used, and a headset may be required. If the system is speaker-dependent, it must be individualized to specific users. If an individual's voice changes (e.g., becomes stressed) a speaker-dependent system may not respond. Speaker-dependent systems require template loading time and background noise may interfere with recognition, but a speaker-independent system may allow unauthorized people to issue commands.

10.4.2.30.4 Track point

The track point is an isometric joystick used as a pointing device. It operates by sensing the force that is applied to it, and the velocity of the cursor depends on the applied force. Its sensitivity can be adjusted. One of the problems with track points is that the cursor drifts, and this needs

frequent recalibration by lifting the finger off it. Track points are usually incorporated into the keyboard, and they are preferred by touch typists because hands do not have to be moved from the keyboard to use the device.

10.4.3 Compatibility of movement

- Displays and controls should be designed so that movement of a control corresponds to a movement on a display.

For example, with knobs, performing one of the following movements of the knob is expected to result in the one of the indicated movements of the display:

- When turned clockwise with hand or fingers: turn function on, increase value, move discrete cursor right, move display left.
- When turned counterclockwise with hand or fingers: turn function off, decrease value, move discrete cursor left, move background page right.
- These movements are defined for controls, and the standards should be used for display-control relationships.
- Controls should be activated in an expected and consistent manner.
- For a control to be intuitive for spacecraft maneuvering, it should move in a direction similar to that of the resulting spacecraft motion.

For example, moving the control stick to the right should also move the spacecraft to the right (right roll), and pulling the stick back should tilt the spacecraft backward (upward pitch).

- Control activation should build on the users' past experience with the same or similar controls.
- Especially during emergency conditions, where response time is critical, control of the spacecraft must be intuitive.

Figure 10.4-26 shows the relationships between commonly expected function of a system and movement of the control.

System Function	Control Movement
On	Up, right, forward, pull
Off	Down, left, rearward, push
Right	Clockwise, right
Left	Counterclockwise, left
Up	Up, rearward
Down	Down, forward
Increase	Up, right, forward, clockwise
Decrease	Down, left, rearward, counterclockwise

Figure 10.4-26 Expected system function and control movement relationships. Source: Campbell, 1998.

- The type or mechanism of control should match the users' expectations; that is, the most commonly experienced control for specific functions should be selected.

A few examples are given in Figure 10.4-27 below.

Control Function	Suggested Control Mechanism
Selection between 2 alternatives or discrete positions; e.g., on/off	Toggle switch, two-position stalk, push-pull knob, push button, or rocker switch; computer interface (touchscreen, mouse, etc.)
Selection among 3 or more alternatives or discrete positions; e.g., climate controls	Slide, multipurpose stalk, discrete rotary knob, three-position toggle or rocker switch, push buttons (for 3 alternatives only), keypad, computer interface (touchscreen, mouse, etc.)
Precise adjustment	Continuous rotary knob or thumbwheel
Gross adjustment	Continuous rotary knob, lever, or touchscreen
Large force application	Lever

Figure 10.4-27 Suggested control selections to match user expectations. (Campbell, et al., 1998)

10.4.4 Control feedback

- Detent controls should be used whenever possible to provide tactile feedback to the user.
- Stops should be provided at the beginning and end of a range of control positions if the control is not required to be operated beyond the end positions or specified limits.
- The system should provide feedback on user actions and system changes.
- The feedback should be clear, easy to understand, and specific to the action.
- If further actions are required from the user, the feedback should be specific.

The feedback is important to ensure that the resulting action is the one intended by the user. This is especially important for commands that are critical or potentially hazardous.

Immediate feedback is very important for preventing the user from initiating an action twice. If the feedback occurs a long time after an event, the user may believe that the event was not properly received and initiate it again.

The feedback provided to the user can be visual, auditory, or tactile.

- The level of feedback should be appropriate for the message it is trying to convey.

A simple change of background color on a display may indicate that the user has completed an action.

Auditory feedback can be effective in communicating important messages, because auditory messages can easily grab a user's attention even when the user is away from the system. Auditory feedback also functions well in conjunction with visual feedback conveying the same message. Presenting the information in both the visual and auditory modalities increases the likelihood that the message will be received in a timely manner by the user. This is especially important in space because the high levels of background noise may impede the user's ability to hear an auditory signal.

Tactile feedback can be used to signal the status of events to the user. This may be especially helpful when the other modalities are restricted, such as during ascent or descent. For example, if a button stays depressed, this may indicate that the function is proceeding, and when it releases the function has stopped.

10.4.5 Use of Stops

The use of a control stop, also called a *limiter* or a *hard stop*, is primarily based on the type of control, the control operation, or the possibility of an unsafe action occurring if a limiter is not employed. More often than not, most control knobs have a detent in addition to a stop. Detents provide tactile feedback to the user on the status of the control knob (e.g., a multi-position control knob). The most common knobs that use detents and stops are rotary knobs. Rotary control knobs are multifunctional in that they can control software (e.g., manipulating a focus box through an array of targets) or hardware settings (e.g., low, medium, and high).

Several types of rotary controls knobs use stops: rotary selector switches, continuous-adjustment thumbwheels, knob gripped by the hand, cranks, and hand wheels. These types of controls can be operated on a continuum (low-medium-high) or binary (open-closed). Normally, stops are used as a safety feature to prevent the hardware from going beyond a set level (e.g., a temperature control or flow valve). The risk of operating a control beyond its set limit could endanger the user and possibly damage the hardware.

With software, a rotary control knob can be used for tabbing navigation in which a focus box is moved among elements (e.g., form fields for text entry or anchored elements such as a submit button). Normally, a right-turn of the knob corresponds to a right movement of the focus box on the display and vice versa for a left-turn. The order of focusing can be determined implicitly (based on physical order) or explicitly (based on a predefined tab index number). In general, tabbing is cyclical, not linear, meaning that the tabbing will cycle to the first/last element when it moves away from the last/first element with movement being top to bottom or bottom to top on the screen. Given this type of navigation, there are commonly *no stops* associated with the control knob. Two types of rotary control knobs are best for use with software: discrete thumbwheel controls and knobs operated by the thumb and index finger.

10.4.6 Protection against inadvertent activation

Actions or commands can be initiated accidentally in any situation as a result of numerous types of human error (e.g., accident, fatigue, inexperience). For example, a user may select the wrong button on a panel, click on the wrong menu in a display, or more serious, order the discharge of a missile. Therefore, when designing a system that interacts with a user, it is important to

implement certain precautions to prevent these errors from occurring and if they do occur, to have easy procedures in place to recover from the error. For example, for a user who has clicked on the wrong menu option on a display, there needs to be a “Back” button that is easily accessible to return to the previous screen. When commands cannot be reversed, such as an abort, steps should be taken to make the command more difficult to initiate (e.g., multi-step command). This will prevent the user from executing an inadvertent command.

- Controls should be protected against inadvertent operation.

Protective measures may include the use of switch guards, covers, separation from other controls, or elements such as command confirmation or multi-step sequences.

- If an inadvertent operation occurs, the system should provide for rapid recovery.

Errors can range from minor to severe. The precise mechanisms for avoidance and recovery vary with the severity of the consequences of the error.

- Minor Consequences – For minor commands, the user should be able to undo an action (procedural step) if an error is made (e.g., selecting the wrong key on a keyboard or navigating to the wrong screen). In these cases the easiest solution is to have a button in place to allow the user to go back to the previous step.
- Significant Consequences – For critical commands, multiple steps must be in place to complete the command and users should be able to correct or undo a command (as with minor consequences).
- Confirmation of Choice – On a display, confirmation may come in the form of a message that requires the user to affirm the choice, and if the command could have severe consequences, the system should require confirmation at every step in the process.
- Multiple Keystrokes – Requiring multiple keys to be depressed simultaneously (for example, Control-Alt-Delete) helps to ensure that the user intends to perform that action. The likelihood that those keys would be simultaneously depressed by chance is rare.
- Confirmation Message – A message to confirm the initiation of the command is beneficial as an additional precaution.
- Multiple Control Movements – Requiring two or more movements to actuate the control, such as pushing and turning the knob on the stove to light it, turning the knob on a combination lock clockwise, counterclockwise, and then clockwise to open it, or requiring the user to disable a cover over a button to access the button, makes the command difficult to initiate and thus less likely to be done inadvertently.

10.4.7 Use of Coding

Labeling is one form of coding and is discussed in section 10.11. This section discusses coding methods other than labeling.

- The use of a coding mode (e.g., size and color) for a particular application should be governed by the relative advantages and disadvantages of each type of coding (see Figure 10.4-28).

- Where coding is used to differentiate among controls, application of the code should be uniform throughout the system.

ADVANTAGES	TYPE OF CODING					
	LOCATION	SHAPE	SIZE	MODE OF OPERATION	LABELING	COLOR
Improves visual identification.	X	X	X		X	X
Improves nonvisual identification (tactual and kinesthetic).	X	X	X	X		
Helps standardization.	X	X	X	X	X	X
Aids identification under low levels of illumination and colored lighting.	X	X	X	X	(When trans-illuminated)	(When trans-illuminated)
May aid in identifying control position (settings).		X		X	X	
Require little (if any) training; is not subject to forgetting.					X	
DISADVANTAGES						
May require extra space.	X	X	X	X	X	
Affects manipulation of the control (ease of use).	X	X	X	X		
Limited in number of available coding categories.	X	X	X	X		X
May be less effective if operator wears gloves.		X	X	X		
Controls must be viewed (i.e., must be within visual areas and adequately illuminated).					X	X

Source: MIL-STD-1472F

Figure 10.4-28 Advantages and disadvantages of various types of control coding.

10.4.7.1 Size Coding

- No more than three different sizes should be used to code controls for discrimination by absolute size.
- Controls used for performing the same function on different items of equipment should be the same size.

- When knob diameter is used as the coding parameter, the differences between diameters should be not less than 13 mm (0.5 in.).
- When knob thickness is the coding parameter, the differences between thicknesses should be not less than 10 mm (0.4 in.).

10.4.7.2 Shape Coding

Shape coding may be used to ensure identification of control knobs or handles by “feel” where visual identification is not possible.

- Shapes must be associated with or resemble the control function, and not alternate functions.
- The shape must not interfere with ease of control manipulation.
- Shapes should be identifiable by hand and by eye regardless of the position and orientation of the control knob or handle.
- Shapes must be tactually identifiable when gloves must be worn.
- The number of shapes to be identified by each operator based on absolute discrimination should be not more than 10.
- Shape-coded knobs and handles should be positively and non-reversibly attached to preclude incorrect attachment when replacement is required.

10.4.7.3 Color Coding for Hardware Controls

Colors may be used only to supplement other control-coding methods.

- Color coding should be done on the control’s label and not on the control itself.
- The color of controls should be a neutral gray or black so that they are consistent across the cockpit. The label associated with each control will vary across the cockpit to provide the functional or descriptive information for each control.
- If color coding is required, not more than five colors should be used. Only the following colors should be selected for control coding:
 - Red
 - Green
 - Orange-yellow
 - White
 - Blue (only if an additional color is absolutely necessary)
- Gloss finishes should not be used on controls where specular reflection (glare) or reduced friction could degrade task performance.

- Color coding should be compatible with anticipated ambient light during the mission.

10.4.7.4 Coding for emergency controls

- Coding for emergency controls should allow the operator to distinguish them from other controls.

It has been shown that operators react more quickly to simple coding such as colors and pictures than they do to written labels.

10.4.8 Restraints for control operation

- The crew should have a means of reacting to any required control input forces without letting those forces push him or her away from the control. This helps the crew maintain position and apply required control forces.

10.4.9 High-g operations

10.4.9.1 Over 3g

- Above 3 g, controls should be operable by a restrained, suited operator.

In a study of reaches under G_x loading with veteran astronauts and aviators as suited subjects, a 6% reduction in forward reach displacement at 3 g, 18% at 4 g, and 32% at 5 g occurred (Schafer & Bagian, Aviation, Space, and Environmental Medicine, 64: 979, 1993). Above 3 g, the accuracy of gross limb movements is compromised; thus, control action under these conditions should be limited to hand and wrist motions alone.

10.4.9.2 Over 2g

- Between 2 g and 3 g, controls should be operable by a restrained, suited operator.

In a study of reaches under G_x loading with veteran astronauts and aviators as subjects, suited subjects on average exhibited little impact at 2g but did show a 6% reduction in maximum forward reach displacement at 3 g (Schafer & Bagian, Aviation, Space, and Environmental Medicine, 64: 979,1993). Hence, between 2g and 3g, even with highly motivated and trained subjects, reaches will begin to show errors above 2g, and so control actions should be limited to hand/wrist motions or forward arm movements within a +/- 30 degree cone (apex at the shoulder joint, aligned with the axis of acceleration).

- For tasks requiring rapid response times or for deconditioned crew, a more conservative approach should be taken – controls should be placed to minimize reach.
- Awkward shoulder/elbow postures, which could result from reaches to displays/interfaces at close distances, will increase fatigue and errors and should therefore be avoided.

10.4.9.3 Supports for control Inputs during high-g

- Operator's arms/legs should be supported and/or restrained to allow for accurate control inputs to remain within task performance limits during elevated g conditions and to prevent inadvertent control inputs during high-g nominal and abort scenarios.

10.4.10 Cursor Control Device Use under Vibration

Movement times with cursor control devices are generally slower under vibration conditions that may be experienced during launch and descent. However, accuracy does not seem to be affected under these conditions (Sandor et al. 2010).

10.4.11 Gloved operations with Cursor Control Devices

Extravehicular activity gloves reduce tactility even when they are not pressurized. Thus, performance with cursor control devices that require fine motor movements is negatively affected when wearing gloves: movement times are slower and accuracy is also reduced. Some devices are less affected by the lack of tactility. In a ground-based study on gloved cursor control device (CCD) use, discrete devices with 4-way operation led to better performance than continuous or 2-way devices (Thompson, Meyer, Sandor, Holden, 2009).

Pressurized operations add additional challenges to the design and operations of CCDs.

10.4.12 Type of Cursor Movement

Continuous devices are faster than discrete devices; however, there are more opportunities to commit errors than with discrete devices

10.4.13 Research Needs

Some of the newer technology controls need to be researched for application to use in microgravity. For example, multi-touch and gesture interfaces.

10.5 DISPLAY DEVICE AND CONTROL LAYOUT

Good layout design of displays and controls can decrease task times and errors. Control-display operational sequences and their relationships need to be apparent through arrangement proximity, similarity of groupings, coding, framing, labeling, and similar techniques.

10.5.1 Two crew operations

Displays can be used by one or multiple operators. Shared usage implies different viewing angles and viewing distances.

- Shared displays should be located within the required viewing angles and viewing distances of all operators.

10.5.2 Viewing critical displays and controls

- Controls and displays that might require rapid response in emergency conditions should be placed in primary manual and visual areas.
- Critical controls should not be located in high-traffic paths or translational paths.
- If controls are placed in these locations, a means should be used to prevent inadvertent actuation.

10.5.3 Viewing frequently used displays and controls

- Frequently used displays and controls should be located in the optimal visual and manual zones. These locations provide the best discriminability, easiest reach, and fastest response.
- Only displays and controls that are necessary and sufficient for the completion of the task should be placed in the main visual field of the user.
- Controls should be placed so that the hand or arm does not obscure the display that needs to be viewable during operations of the control.

10.5.4 Display-Control Relationships

Logical and close relationships of displays and controls reduce mental loads for the user and leave more mental resources for the task itself.

- The arrangement of displays and controls should be logical to reduce task completion time (task time) and errors.
- Displays should be close to the associated controls to ensure that eye-hand coordination and display-control coordination are seamless.

If displays and controls are arranged to support the task flow, their use will be intuitive and logical. If a control is too far from a display, and they are used together, the excessive visual referencing between the two may lead to difficulty perceiving all changes on the display and focusing on the control task.

- Any change made with the controls should be easy to follow on the display.

To meet this objective, the proximity of the control to the display is essential, along with good visibility of the display. Proximity is important for reducing and eliminating errors, maintaining efficient task flow, and reducing task times.

10.5.4.1 Orientation

- The orientation of displays and controls should be as consistent as possible and be designed to be compatible with crew orientation during procedures.

- Requiring crewmembers to reach out for displays or controls or to assume an uncomfortable position to use any device should be avoided whenever possible.
- Controls located directly adjacent to the user should be oriented so that the operator is not likely to strike or move them accidentally in the normal sequence of movements.

10.5.4.2 Location and Arrangement

- Layout design of displays and controls should consider the task flow, relative importance of the displays and controls, and frequency of use.
- Displays should be close to the associated controls to make sure that the eye-hand coordination and display-control coordination are seamless.

This standard approach is important for reducing errors, maintaining task flow, and reducing task times.

- Any change made with the controls should be easy to follow on the display; this will require close proximity and good visibility of the display.

Display-control operational sequences and their relationships should be apparent through arrangement proximity, similarity of groupings, coding, framing, labeling, and similar techniques.

- Consider the following for the arrangement of displays and controls:
- Controls and their associated displays should be located together.
- Functionally related controls and displays should be located close to each other and arranged in functional groups, e.g., power, status, and test.
- Functional groups of controls and displays should be located to provide for left-to-right (preferred) or top-to-bottom order of use, or both.
- Provided that the integrity of grouping by function and sequence is not compromised, the more frequently used groups and the most important groups should be located in areas of easiest access. Control-display groups required solely for maintenance purposes should be located in positions providing a lesser degree of access relative to operating groups.
- Displays and controls should be located and designed so that they may be used to the required degree of accuracy by personnel in their normal operating or servicing positions without need to assume uncomfortable, awkward, or unsafe postures.
- Displays and controls should be located so that their faces are perpendicular to the operator's normal line of sight whenever feasible and should be no greater than 45° from the normal line of sight.
- Displays and controls should be constructed, arranged, and mounted to prevent reflection and glare.
- Displays and controls should be located in the operator's field of view, which is a function of the operator's size, orientation, position, and constraints (e.g., a helmet).

10.5.4.3 Display and control grouping

Grouping means that when the information is presented all on one display, related items appear together and are distinct from unrelated items, and that items used in a sequence are grouped together. These properties are important in preventing the user from having to navigate through multiple pages to find the information they are looking for.

- To make an interface simple for the user, related items should be grouped together.
- Where sequential operations follow a fixed pattern, controls should be arranged to facilitate operation (e.g., a left-to-right / top-to-bottom pattern, as on a printed page).
- If a series of controls has no specific sequence or functional relatedness, they should be arranged with the most frequently used or most important as the most accessible.
- Related items should be grouped together, either in a logical sequence in time or in a similar location in space.

Displaying information in a logical sequence in time means that the flow of information from one display to another follows a logical, predictable sequence.

- The sequence should be predictable in the sense that the flow of information starts at a high (global) level and continually becomes more specific.

10.5.4.4 Display and control spacing

Display spacing affects grouping, alignment, and readability. Spacing can separate groups of information and make the display easier to use. Good spacing increases readability, decreases task completion time, and reduces visual fatigue.

- Displays and controls that are used together should be grouped together. This allows easy access to the whole group.
- Unrelated groups of displays and controls should be placed farther away from each other so that when one group is used, displays and controls from the other groups are not in the way of the task.
- Controls should be spaced so that they can be accessed and operated by crewmembers who are suited for all expected operational environments.

Spacing depends on the type of control. A switch may require minimal spacing since a simple motion of a single finger can actuate the switch. However, for controls such as knobs, spacing must be sufficient for multiple fingers and the motion to turn the knob.

- Recommended minimum control spacing for barehanded operations is shown below in Figure 10.5-1.

The figure shows only the spacing between dissimilar controls; recommended spacing between the same control types is given in the section that describes that control type.

	TOGGLE SWITCHES	PUSH BUTTONS*	CONTINUOUS ROTARY CONTROLS	ROTARY SELECTOR SWITCHES	DISCRETE THUMBWHEEL CONTROLS
TOGGLE SWITCHES	' ---	13 mm (0.5 in)	19 mm (0.75 in)	19 mm (0.75 in)	13 mm (0.5 in)
PUSH BUTTONS ¹	13 mm (0.5 in)	' ---	13 mm (0.5 in)	13 mm (0.5 in)	13 mm (0.5 in)
CONTINUOUS ROTARY CONTROLS	19 mm (0.75 in)	13 mm (0.5 in)	---	25 mm (1.0 in)	19 mm (0.75 in)
ROTARY SELECTOR SWITCHES	19 mm (0.75 in)	13 mm (0.5 in)	25 mm (1.0 in)	---	19 mm (0.75 in)
DISCRETE THUMBWHEEL CONTROLS	13 mm (0.5 in)	13 mm (0.5 in)	19 mm (0.75 in)	19 mm (0.75 in)	---

*for pushbuttons not separated by barriers

NOTE: All values are for one hand operation.

Figure 10.5-1 Recommended minimum spacing between controls (for bare-handed operations). Recommended minimum control spacing for suited glove operations are shown below in Figures 10.5-2 and 10.5-3. Source: MIL-STD-1472F.

TBD

Figure 10.5-2 Recommended minimum spacing between controls (for pressurized suit glove operations) (under development).

TBD

Figure 10.5-3 Recommended minimum spacing between controls (for unpressurized suit glove operations) (under development).

10.5.5 Successive operation of displays and controls

- All displays and controls necessary to support an operator activity or sequence of activities should be grouped together.
- Displays and controls should be arranged in relation to one another according to their sequence of use or the functional relations of the components they represent.
- Whenever possible, displays and controls should be arranged in sequence within functional groups and provide a flow from left to right or top to bottom.

Functional relations and flow can be determined by task analysis and other methods.

10.5.6 Obscured controls

- Controls designed to be out of view while being operated should be spaced or shaped/textured such that the control can be identified with a pressurized gloved hand without line of sight.

This would include controls for vehicle operation as well as other controls (e.g., seat positioning). It has been shown that human operators can use simple tactile coding to reliably distinguish between items.

10.5.7 Self-illuminated controls and displays

Self-illumination (i.e., backlighting, trans-illumination, or integral lighting) of interfaces on a control panel provides contrast that is independent of external panel illumination. With an available dimming function, luminance can be adjusted for legibility in operational low or high ambient illumination conditions. The term “panel” is intended to include any push-button switches or data entry keyboards that may have self-illuminated markings.

10.5.8 Reach requirements

- Controls should be located within reach of the operator. This is a function of the operator’s size, orientation, position, constraints such as a suit, and environmental factors such as acceleration and vibration.
- Reach Zones – Controls should be located within the reach zones of the smallest and largest crewmembers. This depends on anthropometric measurements as well as range of motion.
- Frequently Used – The most important and frequently used controls (particularly rotary controls and those requiring fine settings) should have the most favorable position for ease of reaching and grasping.
- Emergency – Emergency controls should be located as close to the user as possible, to minimize any delay in activating them under emergency conditions.
- Consistency – The arrangement and location of functionally similar, or identical, controls should be consistent from panel to panel throughout the system.
- Acceleration and Vibration – Controls that are used during high acceleration or vibration (see sections 6.5 and 6.7) should be located and designed so that the operator can make accurate control inputs.
- Handedness – Hand controls should be located where they are operable by either hand. If they can be operated by only one hand, then consideration should be given to having both right-hand and left-hand versions available.
- Reduction of Movement – Controls should be oriented so that their operations are consistent with the users’ dominant hand and arm position.

10.5.9 Research Needs

Controls that can adapt to deconditioned crew need to be researched for application to long-duration missions.

10.6 VISUAL DISPLAYS

Crewmembers rely on computer-generated informational displays for virtually all of their tasks. It is critical that this information be relevant to the task, interpretable, readable from a number of locations, and organized in a logical manner.

10.6.1 Task-relevant Information

Mission success depends on the availability of task-relevant information in a form that is easy for crew to read, interpret, and use in a timely manner.

- Information should be sufficient to allow the operator to perform the intended mission, but limited to information necessary to perform specific actions or to make decisions.

The appropriate information to be displayed to a crewmember for performance of a task should be driven by a task analysis, and verified through scenario-based usability testing, as part of a human-centered design approach. A properly conducted task analysis will lead to the identification of the critical tasks and subtasks, the information required for display, the level of detail needed, and any associated time constraints for access to the information. This information should be used to inform display design to ensure that the required information is available in the proper format within the anticipated time constraints.

When monitoring spacecraft displays, the crewmember's task is often to assess the following: What is the value or state? Is it out of range? Is it trending out of range? How does it compare to a default/standard/expectation?

- Information should be displayed only within the limits and precision required for specific operator actions or decisions.

Sometimes the value itself is required, and sometimes a simple binary summary provides the quickest answer (green is in range, red is out of range). In general, displays that use graphics, colors, and symbols are processed more quickly than displays that are text- or digit-heavy. This principle can break down, however, if overused. For example, when many symbols or colors are used, the crewmember may not remember all the meanings. If a multidimensional symbol is used to convey many bits of information, but is so complex that it requires significant time to remember/interpret the meaning, the efficiency of the compact design is lost.

- The unit of measure presented should be the one required for the task.

In other words, there should be no need for transposing, computing, interpolating, or mentally translating into other units (e.g., for more details on verbiage and abbreviations including acronyms, see sections 10.6.3 and 10.6.4).

- Care should be taken when designing displays for multiple purposes/users. For example, operations and maintenance information should not be combined in a single display unless the information content, format, and timelines support the needs of both users.

- Information required for flight, docking, systems, and other critical activities, should be integrated to reduce scan, resolve ambiguity, and improve interpretation during a full range of flight related tasks.

For instance, many glass cockpit displays have both primary flight displays (PFD) and adjacent multi-functional displays (MFD). PFDs can incorporate a digital, vertical dynamic tape format distributed around the attitude indicator. These formats have facilitated the integration of flight data to enhance performance by reducing the cost of increased workload associated with traditional scanning patterns necessary to mentally integrate pieces of information. By bringing related flight information into a narrow field of view there is a reduced load on working memory (Tsang & Vidulich, 2002), reduced vestibular disorientation, and economization of panel real estate that previous multiple single-data gauge configurations consumed. Systems, positional information, flight planning, weather, electronic checklists, and hazard information is retrievable from the MFD on a selectable basis when needed. Display integration relies on detailed task analyses and information assessment to appropriately identify that information which can, and should, be integrated.

10.6.2 Minimal Information

- The display of information at any one time should be as simple and minimal as possible.

Designers should avoid cluttered displays. As the amount of information on a display increases (Wickens & Hollands, 2000), the time it takes the user to find a given piece of information increases. This means that the more information there is on a display, the slower the users will be in completing their tasks.

- The information should be organized so that it is easy to find and is not obscured by unnecessary information on the display.

10.6.3 Language and Abbreviations

Abbreviations save space on a display and this can be an important issue when space is limited.

- Abbreviations should be used as sparingly as possible. If they must be used, make sure that target users are familiar with them.
- The definitions for any abbreviations used should be available to the user.

10.6.4 Effective and Consistent Verbiage

- The verbiage used on a display should be simple and common.
- If domain-specific verbiage is needed, it should be common to that domain, so that it can be understood by a person with minimal training.

The verbiage for each item or process should be self-explanatory and direct the user to the function or usage of the item. Terminology should be short and concise, and adequately convey the intended meaning.

- The name of a control, display, piece of equipment, or process should reflect its function and what it does in the mission.

Terms that describe part names or engineering functions are more difficult to learn and remember.

- The nomenclature, or verbiage, used to describe each item of a system, the syntax, and procedure presentation should be consistent across all aspects of the system.

Consistency in verbiage includes nomenclature, syntax, and procedures. When a word is used to describe an item, the user learns the association between that word label and the meaning it is intended to convey. If this association changes or deviates at any point in the user's interaction with the system, the user will become confused about the operations of the item. The change can occur by either changing the label or by attaching a new meaning to the label. Either of these outcomes will confuse the user and should be avoided. The syntax refers to the arrangement of words in a sentence, or the order of information presentation. This means that the presentation of the words and the order of procedures should be consistent across the system.

10.6.5 Display density and hierarchy

- The amount of information on a given display should be necessary and sufficient to complete the current task.
- Supplemental information should be available on request.
- When there are less frequently used display items that do not have high criticality or short time-to-react requirement associated with them, then those items should be moved to a separate display.

This layering approach reduces the amount of clutter on a display at any given time and thus the amount of information a user needs to process at any one time. However, the crew must have situation awareness regarding where they are in the display hierarchy to maintain efficiency during display navigation. Thus, it is important to provide information regarding the operator's location within the hierarchy.

It is often erroneously believed that the best approach to a good display is to minimize the number of clicks the operator must make by putting a large amount of information on the display, but this often results in severely cluttered displays. The use of cluttered displays requires high levels of attention and serially searching for information, resulting in high mental effort and increased risk of errors, especially under conditions of high stress or arousal.

10.6.6 Identification

- Each display and display element should be easy to identify so that the user can quickly recognize it.

A system usually has multiple display elements, each with different functions. Easy identification can be based on features such as location, size, shape, or color. The same principles are valid for sections of a display.

10.6.7 Grouping

Good grouping and logical flow can increase the simplicity and usability of a display. Grouping is important for task flow support and to make visual search easier on the display. Grouping can be attained in multiple ways: similarity, closure, grouping by using a border.

- Elements that belong together based on the task flow should be placed in proximity to one another such that they form a visual group. They can also be grouped by similar color or similar shape.

10.6.8 Distinctiveness

10.6.8.1 Operational Distinction

- If there is likelihood that two commands will be confused with each other, operational distinction should be used. Operational distinction involves requiring the user to perform different manual actions or procedures to initiate each command.

Physical controls can be differentiated by the type of control and the direction used to actuate them. A very simple example of behavioral distinction with physical controls is the light switch: up for on and down for off. With respect to the expected operating orientation, the most common direction for an action (e.g., up/down, left/right) must be used. Physical controls can also be differentiated by the intensity of the movement required to actuate them. For example, simple commands can be initiated by a simple button press, whereas commands whose actions will have a more important consequence may require more force to actuate.

One of the most efficient ways to differentiate commands is to require a multifunction process to initiate each command. A multifunction process requires the user to complete a specific sequence of events to initiate a command. For example, on a Microsoft® Windows computer, the key sequence “Ctrl Alt Delete” brings up the Windows security menu, allowing the user to then access the Task Manager or to log off, whichever is the resulting intended action. One of the most beneficial aspects of the multifunction process is that it prevents accidental actuation of that action. An example of a multifunction process would be lifting a guard cover before gaining access to a specific switch.

10.6.8.2 Discrimination

- Crewmembers need to be able to discriminate between displays and controls, and their individual elements.
- Displays and controls should have features such as color and shape that make them sufficiently different from each other.

If they are similar, confusion may occur, resulting in errors. To avoid errors, use consistent, differentiable displays and controls.

10.6.8.3 Syntax Distinction

- Syntax to initiate different commands should be distinct in appearance, content, and overall structure.

For example, the lowercase letter “l” and the number “1” look very similar and can easily be confused with each other. Commands should not contain syntax that is contingent on differentiating these similar items.

10.6.8.4 Spatial Distinction and Grouping

- Distinct actions should be differentiated by their spatial location, and physical controls should be physically grouped by outcome results.

For example, physical controls that actuate environmental systems can be grouped together and separately from controls that actuate propulsion systems.

Display controls can be grouped by location on the interface or the virtual path used to access that control. Grouping by display location is similar to the physical control grouping. Controls to delete should not be located next to controls to save or send.

Grouping by virtual path involves differentiating items on the basis of names of steps or categories selected previously. For example, initiating Microsoft Word® on a computer involves navigating to the Start menu, selecting the program menu, selecting Microsoft Office®, and then selecting Microsoft Word. Selecting this program is differentiated from selecting the volume control by the general category (program vs. settings) and sublevel category (Microsoft Office vs. control panel) steps involved in accessing them. Requiring users to navigate these paths results in less confusion than would occur if the two respective icons were adjacent to each other on the desktop.

10.6.9 Spacing

- Spacing should be used to separate displays and groups of information on displays to make the display easier to view and to find information.

10.6.10 Alignment

- Display elements should be aligned, to reduce clutter and support easy visual search and grouping.

10.6.11 Scrolling

A scroll bar is included in an interface if an area has scrolling content. Vertical scrolling is appropriate most of the time because computer users are experienced with vertical scrolling.

- Horizontal scrolling is never recommended, especially when vertical scrolling is also required.

- Vertical scrolling should be limited when motor skills may be impaired by environmental or other factors (e.g., high-g environments).

When scrolling is not a good option for the structure of the display, paging may be appropriate, that is, moving from page to page. When the system response time is fast, paging may be a better option, especially if users are not reading for comprehension but rather are accomplishing a task.

10.6.12 Navigation

- Navigation from one display or section of a display to another should be intuitive and efficient.
- A system design goal should be to have the fewest number of navigation levels as operationally required for the tasks.

Navigation between displays is time consuming, may add operational complexity, and requires training/memory to carry out.

- Navigation should be consistent across the software in color, label, positioning, and other features.
- The interface should provide indication to the user about their location within the structure of the display.
- There must always be a way to get back to the previous software display or to the starting display.

A navigation structure or site map may be helpful in allowing users to get an overview of the structure.

10.6.13 Selection

- Selectable elements on a display should have distinctive features.

For example, in Microsoft Windows® interfaces, text in selectable text field areas has a white background that indicates that the text is selectable and editable. Selectable standard buttons look three-dimensional and have a stronger gray color than buttons that are not clickable.

- When a user selects an interface element, the user should receive feedback to indicate that the element has been selected.

To use the example of the selectable text, selection causes the text's background color to change from white to a blue or dark gray.

10.6.14 Menus

- Menus should be intuitive and have clear labels.
- The number of items in a menu should be minimized.

If there are too many items, it is difficult for the user to find the option needed.

- The number of submenu items should also be limited.

Having multiple submenus with multiple options makes it difficult to remember the options under each. Multiple submenus are also cumbersome to use because of the multiple clicks and fine motor movement required.

- Menus should be distinct from the main content of the display.

Menus should be clearly readable with good visual contrast and labels.

- Menus should also be consistent across different displays within the same application.

It is confusing for users to see different labels that lead to the same results when activated.

10.6.15 Toolbars and Status Bars

Toolbars usually contain menus and icons that allow activation of commands and functions. Toolbars may be in a fixed position or they can “float” on the screen and be dragged to more convenient locations.

A status bar is a horizontal line of information displayed at the top or bottom of a software display. It displays information about the current state of the software. It may also show progress bars that indicate the progress (in time) of the processes occurring on the software display.

10.6.16 Dialog Boxes

A dialog box is a window that appears on the screen and presents information or requests some input from the user.

- Dialog boxes should allow interaction to be continued with the rest of the interface without forcing the user into the mode of operation of the dialog box; that is, dialog boxes should be non-modal.

Modal dialog boxes temporarily stop the program and the user cannot continue without closing the dialog box. This type of dialog box should be avoided or used infrequently.

- The language used in dialog boxes should be simple, natural language that is easy for users to understand.
- Dialog box language should provide the necessary and sufficient information for the situation, and if applicable, provide a suggestion for resolving the situation.

Dialog boxes may be used as an aid for composing complex control entries. For example, for a print request, a displayed form might help a user invoke the various format controls that are available.

10.6.17 Modes

A mode is a setting in which the user input produces actions different from those that it otherwise would, or that it would in a different mode. For example, pressing the Caps Lock key on a keyboard takes the system into capitalization mode, in which depressing any letter key

prints that letter in a format different from the one that it would print if the Caps Lock key were not depressed.

- **In general, modes should be avoided.**

Modes lead to what are called “mode errors,” in which users input a command different from the one intended, usually because they forget which mode they are in. The user then needs to correct the error and re-perform the action they intended. Modes also require the user to shift the state of the operating system, which takes time and requires a level of fluency with the system. An example of a system with mode settings that were poorly designed is one in which the same interface design is used for two different modes. This makes it hard for users to determine which mode they are in without switching from mode to mode or restarting the program. This condition should be avoided.

- If it is necessary to implement a modal system, then design factors should be in place to clearly signal to the user which mode is in effect.

10.6.18 Use of Graphics

- Graphical representations should avoid clutter and high density.
- Graphical representations should have good grouping, clear representation, and task orientation.
- A graph or image should have high resolution and size for good readability.
- Graphics should be simple, so that the meaning is easily extracted from them.
- The number of graphics on a display at any one time should be limited to only those necessary; graphics for purely decorative purposes should be minimized.
- Careful consideration should be given to the choice of graphics, to ensure that the meaning is obvious. For example, photographs sometimes display too much information, which can cause confusion. A line drawing can eliminate extraneous information and allow the user to focus on the purpose of the illustration.
- Any displayed grid lines should be unobtrusive and not obscure data elements. Grid lines should be displayed or suppressed at the option of the user.

10.6.19 Use of color

Color is an important attribute of most contemporary display technologies and many display applications. Color is often a dimension of natural images and may be used as an information code in synthetic images by the process of pseudo-color encoding. Graphics and character displays also frequently use color for information coding. Color is especially effective for organizing and segmenting visual information and for facilitating visual search. The effective use of color in visual displays requires careful colorimetric characterization of the display, stable

methods for the control and management of color throughout the imaging chain, and a rational basis for the representation of color in the images displayed to an observer.

- The color vision capabilities of the crew should be considered in design.
- Color-coding should not be used as the only means of conveying information, indicating an action, prompting a response, or distinguishing a visual element; it should be redundant with some other means of coding.

A wide variety of color metrics are available for characterizing the performance of visual displays. Most of these are based on color measurement methodology and standards developed by the CIE (Commission Internationale de L'Eclairage (CIE), 1978, 1995, 1996, 2001; Hunt, 2004; Wyszecki & Stiles, 1982). This section describes those color metrics of most importance for characterizing visual displays.

Displays and controls can be grouped using color. Color is a strong attribute that can be very effective in marking displays and controls.

- Colors should be used consistently for grouping displays and controls.
- Some colors, such as red for emergency, should be reserved for distinctive cuing and are not used for other purposes.

Color choice usually depends on other similar conventions (see section 10.11.5.5 for a more detailed discussion of the colors used for certain items).

- The use of too many colors should be avoided to prevent the so-called “Christmas tree” effect that can distract users from their main task.

Color is a very strong factor in orienting attention and should be used to facilitate the task rather than distract from it. Color contrast should be great enough that the color is clearly visible to serve its purpose of grouping, and colors should be chosen so that color-deficient observers can distinguish between them.

10.6.20 Use of Cues

- User interfaces should reduce the demand on user memory through the use of prompts, labels, menus, and other salient cues.

Indicators, prompts, and cues assist the operator in gaining awareness of system status or determining appropriate action by minimizing cognitive effort. Cues may be visual, auditory, or tactile. Research has shown that recognizing an item using a cue is usually faster and more accurate than recalling the same item from memory without an aid (Anderson & Bower, 1973).

10.6.20.1 Visual cues

- Visual cues should be used to indicate important or complex information in a simple manner. Such indication may include using symbols, labels, prompts, and/or color.

10.6.20.2 Auditory cues

An auditory cue is any type of auditory signal that has a predefined meaning for users.

- Auditory cues should be used to remind the user to perform a task, convey alerting messages, and/or provide redundant information when used in conjunction with visual cues.

Auditory cues are very useful for reminding the user to perform an action. For example, an alarm may sound, indicating that it is time for a meeting. At times, providing a cue other than visual can prevent overload of visual cues, which can elicit attention more effectively. Auditory alarms also have the advantage of not requiring the user to be in a specific location to receive the message, which is not normally true of a visual cue. Presenting information in both visual and auditory modalities increases the likelihood that the user will receive the message and respond to it in a timely manner. Using both visual and auditory cues is especially useful in space because the high levels of background noise may impede the user's ability to hear an alert.

10.6.20.3 Tactile cues

- Tactile cues should be used to provide feedback to the user, and/or provide redundant information in conjunction with visual or auditory cues.

Tactile information is the least salient of the cue types, and recognition of a tactile cue can be weakened by distractions. Tactile cues include vibration, mouse clicks, texture, shape, and size. For example, vibration can be an effective way of communicating a message, such as when a cell phone vibrates to indicate an incoming call. However, in the spaceflight environment, where vibration may occur from system functions, the appropriate time and frequency to deliver a message in this form should be considered. Texture can be used in a way similar to Braille. In a common example, raised bars on the “f” and “j” keys of the keyboard indicate which keys the fingers are on in the absence of sight. This type of tactile cue informs the user of the state of their hands. The shape and size of objects also allow easy recognition, even in the absence of visual cues.

10.7 AUDIO DISPLAYS

Audio displays are the collection of systems that transmit information to the crew through sound, and include:

- Two-way speech communications equipment
- Audio annunciators and alarms (one-way)
- Sound combined with visual displays (usually computer-generated)
- Auditory alarms – Because the proper function of these displays is critical, a separate section is devoted to them.
- The following factors are discussed in this section for each of the above items:

- Selection of the proper auditory display
- Signal design
- Auditory equipment design
- Design of direct user interface (including controls and displays)

Section 6.6 Acoustics discusses the sound characteristics of speech communications and assessment of intelligibility.

10.7.1 When to Use

- Audio displays should be provided under the following conditions:
 - The information to be processed is short, simple, and transitory, requiring an immediate or time-based response.
 - The common mode of visual display is restricted by overburdening; ambient light variability or limitation; operator mobility; degradation of vision by vibration, high g forces, hypoxia, or other environmental considerations; or anticipated operator inattention.
 - The criticality of the event makes supplementary or redundant notification desirable.
 - It is desirable to warn, alert, or cue the operator to subsequent additional response.
 - Custom or usage has created anticipation of an audio display.
 - Voice communication is necessary or desirable.
 - Crewmembers are not at specific stations and fixed visual displays will not be noticed.
 - Auditory presentation is preferred over visual presentation for the following signals and situations:
 - Signals of acoustic origin
 - Warning signals to call attention to imminent or potential danger
 - Situations when many displays are visually presented
 - Situations when information is presented independently of head orientation
 - Situations when darkness limits vision or makes seeing impossible
 - Conditions of anoxia or high positive g forces
 - Situations when signals must be distinguished from noise, especially periodic signals in noise
- Selection of Signal Type

When an audio presentation is required, the optimum type of signal should be presented in accordance with Table 10.7-1.

Table 10.7-1 Selection of Audio Signals

TYPE of SIGNAL			
Function	Tones (periodic)	Complex sounds (non-periodic)	Speech
Quantitative Indication	Poor Maximum of 5 to 6 tones absolutely recognizable.	Poor Interpolation between signals inaccurate.	Good Minimum time and error in obtaining exact value in terms compatible with response.
Qualitative Indication	Poor to Fair Difficult to judge approximate value and direction of deviation from null setting unless presented in close temporal sequence.	Poor Difficult to judge approximate deviation from desired value.	Good Information concerning displacement, direction, and rate presented in form compatible with required response.
Status Indication	Good Start and stop timing. Continuous information where rate of change of input is low.	Good Especially suitable for irregularly occurring signals (e.g., alarm signals).	Poor Inefficient; more easily masked; problem of repeatability.
Tracking	Fair Null position easily monitored; problem of signal-response compatibility.	Poor Required qualitative indications difficult to provide.	Good Meaning intrinsic in signal.
General	Good for automatic communication of limited information. Meaning must be learned. Easily generated.	Some sounds available with common meaning (e.g., fire bell). Easily generated.	Most effective for rapid (but not automatic) communication of complex, multidimensional information. Meaning intrinsic in signal and context when standardized. Minimum of new learning required.

From MIL-STD-1472F.

10.7.2 General Design

- Audio displays should be audible and intelligible under all conditions of intended use.
- Audio displays should include the following design features:
- False Alarms – The design of audio display devices and circuits should preclude false alarms.

- Failure – The audio display devices and circuits should be designed to preclude warning signal failure related to system or equipment failure and vice versa. Positive and attention-demanding indication should be provided if failure occurs.
- Circuit Test – All audio displays should be equipped with circuit test devices or other means of operability testing.
- Disable – An interlocked, manual disable should be provided if any failure mode can result in a sustained activation of an audio display or when the signal has been acknowledged and no longer contributes useful information. There should be a visual indication of “off” status.

10.7.3 Signal Design

10.7.3.1 Nonspeech Signal Design

- Nonspeech signals should be designed with consideration of the following features:
- Discrimination – When several different audio tones are to be used to transmit information, discriminable differences in intensity, pitch, beats and harmonics, or temporal patterns should be provided. Humans are capable of identifying a maximum of 5 or 6 things absolutely (without direct comparison). This applies to audio tones.
- The number of audio tones to be identified absolutely should not exceed four.
- Interference with other sounds – Audio signals should not interfere with other sound sources, including verbal communication. When speech supplements are used, the length of the initial alerting and the actual message should not interfere with other auditory inputs, including interpersonal voice communication, unless the message is critical.
- Signal meaning – Each audio signal should have only one meaning.
- Signal characteristics – Even when it is considerably weaker than the background noise, if the signal is a sinusoid (pure tone) or a combination of sinusoids (complex tone), the ear can detect it. The ear acts as an effective detector of periodic signals in noise.
- Apparent urgency – The attention-gaining characteristics of the signals in a set (e.g., rapidity of pulse pattern, frequency, and intensity) should match the relative priority of the signal.
- Use with several visual displays – If immediate discrimination is not critical to personnel safety or system performance, one audio signal may be used in conjunction with several visual displays.
- Manual overrides – Noncritical audio signals should be capable of being turned off/disabled at the discretion of the user. Where this capability is provided, a visual indication that the signal has been turned off should be provided to the user.

10.7.3.2 Speech Signal Design

Consider the following features when configuring spoken message:

- Use – Speech displays may be used where mobility is necessary or where the user’s eyes are busy. They should announce discrete events, not continuous status information. They should not be used if display use frequency is high, if simultaneous display of multiple messages is required, if messages are long, if messages include information that must be memorized, or if messages include a series of instructions that must be remembered.
- Output rate – All speech displays should provide an output rate that supports the intelligibility and context of the message.
- Digitized speech – High-quality synthesized speech is preferred to digital recordings of actual speech.
- Message priority control – Where simultaneous messages could occur, they should be prioritized so that the initial presentation of the most critical message receives transmission priority and overrides messages lower in priority.
- Instructional display structure – Instructional prompt messages should be structured with the desired goal first, followed by the desired action (e.g., “to delete, press enter” rather than “press enter to delete”). Prompts should be repeated after a user command or 10 seconds of inactivity.
- Message cancel capability – A manual cancellation capability should be provided for all speech displays after the initial presentation.
- Repeat capability – User-commanded repetition of messages should be provided.

10.7.4 Design for Audio Input and Output Equipment

10.7.4.1 Frequency Response

- Microphones and other input devices, loudspeakers and other output devices, and associated audio system devices should be designed to respond optimally to the part of the speech / audio spectrum that is most essential to intelligibility (i.e., 200 to 6,100 Hz).
- Where system engineering necessitates speech transmission bandwidths narrower than 200 to 6,100 Hz, the minimum acceptable frequency range should be 250 to 4,000 Hz.
- Amplitude variation across the frequency response bandwidth should not be more than ± 6 dB for the end-to-end onboard distribution system, including speakers, earphones, and microphones.

10.7.4.2 Microphones and Other Input Devices

- Dynamic Range – The dynamic range of microphones and other input devices should be great enough to admit variations in signal input of at least 50 dB.
- Noise Canceling – Noise-canceling microphones and other input devices are required for high-noise environments (85 dBA or above) and are preferred in all areas.

10.7.4.3 Loudspeakers and Other Output Devices

- Sidetone – When listening while using a headphone, the speech signal of a talker’s voice should be delivered to their own headset without a perceivable time delay.
- Multiple Channels – Audio equipment used to feed multiple channels into the same speaker or earphone should comply with the frequency response characteristics as stated in paragraph 10.13.4.1.
- Headsets – If listeners will be working in high ambient noise (85 dBA or above), binaural rather than monaural headsets should be provided. Unless operational requirements dictate otherwise, binaural headsets should be wired so that the sound reaches the two ears in opposing phases. Their attenuation qualities should be capable of reducing the ambient noise level to less than 85 dBA. Provisions should be incorporated to furnish the same protection to those who wear glasses.
- Loudspeaker Alarm Audibility – Loudspeakers should produce nonspeech auditory annunciations that exceed the masked threshold by at least 13 dB in one or more one-third octave bands where the alarm resides, as measured at the crewmember’s expected work and sleep station head locations. The 13 dB signal-to-noise ratio ensures that nonspeech auditory annunciations are sufficiently salient and intelligible, according to ISO 7731:2003 – an accepted standard for ensuring the ability to detect and discriminate nonspeech alarms and alerts.

10.7.4.4 Use of De-Emphasis

- When transmission equipment uses pre-emphasis and peak-clipping is not used, reception equipment should use frequency de-emphasis of characteristics complementary to those of pre-emphasis only if it improves intelligibility (i.e., de-emphasis should be a negative-slope frequency response not greater than 9 dB per octave over the frequency range 140 to 4,800 Hz).

10.7.4.5 Feedback Noise

- Feedback noise should be eliminated from voice communication systems.

10.7.4.6 Isolation of Feedback from Earphone or Speaker to Microphone

- Sufficient electrical, mechanical, and acoustical isolation should be provided to preclude feedback oscillations (squeal problems) or echo effects (no discernible unwanted voice echo to speaker).
- Gain of the system loop from earphone or speaker to microphone should be limited to less than 1.

10.7.4.7 Reverberation Time

- The system should provide a reverberation time in the crew habitable volume of less than 0.6 seconds within the 500 Hz, 1 kHz, and 2 kHz octave bands.

- This 0.6 second reverberation time standard will limit degradation of speech intelligibility to no more than 10% for ideal signal-noise ratios of > 30 dB, or 15% for a signal-noise ratio of 3 dB (Harris, 1991).

10.7.5 Audio Interface Design

10.7.5.1 Operator Comfort

Operator comfort and convenience needs are listed below.

- Comfort – Communication equipment to be worn by a crewmember (e.g., headphones) should be designed to preclude operator discomfort. Metal parts of the headset should not come in contact with the user’s skin.
- Hands-Free Operation – Operator microphones and headphones should be designed to permit hands-free operation under normal working conditions.

10.7.5.2 Annunciator Controls

- Manual Silencing – The crew should have the ability to silence an audible alarm that would otherwise annunciate continuously, to prevent it from interfering with their response to the underlying fault.

There are well-known instances of aircraft crews being functionally incapacitated by audible alarms that they could not cancel. In addition, crews may become habituated to the sound and cancel the alarm without completing the corrective action.

- Consideration should be made for re-initiating a cancelled alarm if corrective action has not been accomplished within a reasonable amount of time, so as to counter the tendency to silence the alarm simply to remove the distraction.
- Volume Control for Auditory Annunciations – The crew should have the ability to adjust the volume of non-caution and warning signals to make desired signals intelligible.
- The system should provide a volume control from 5 to 100% of maximum for audio channels carrying aural annunciations, with the exception of caution and warning signals.

Analogous to safety requirements in commercial aircraft, the crew does not adjust the caution and warning audio levels.

- Caution and warning audio levels should be adjusted relative to the predicted background noise level.

Provision is made to silence the alarm, but it must be audible initially above the masked threshold.

10.7.6 Voice Communication Controls

Guidelines for the design of operating controls for voice communication equipment are provided below.

- Accessible volume or gain controls should be provided for each communication-receiving channel (e.g., loudspeakers or headphones) that has enough electrical power to drive sound pressure level to at least 110 dB overall when using two earphones.
- Pressure-operated gain control switches should be provided to compensate for volume attenuation in underpressurized areas.
- The system should provide a volume control from 5 to 100% of maximum for each audio channel that carries voice communications.
- The minimum setting of the volume control should be limited to an audible level (i.e., it should not be possible to inadvertently disable the system with the volume control).
- While separation of the adjustment controls for power (ON/OFF) and volume is preferred, if conditions justify their combination, a noticeable detent position should be provided between the OFF position and the lower end of the continuous range of volume adjustment. When combined power and volume controls are used, the OFF position should be labeled.
- Squelch Control – Where communication channels are to be continuously monitored, each channel should be provided with a signal-activated switching device (squelch control) to suppress channel noise during no-signal periods. A manually operated ON/OFF switch should be provided to deactivate the squelch when receiving weak signals.

10.7.7 Research Needs

TBD

10.8 CREW-SYSTEM INTERACTION

10.8.1 Feedback

- The system should provide feedback on user actions and system changes.

The feedback is important to ensure that the system is responding to the user's actions in a way intended by the user. The feedback should be clear, easy to understand, and specific to the action. If further actions are required from the user, the feedback should be specific, and timed to allow sufficient consideration and execution of these further actions.

10.8.2 Types of Feedback

The feedback provided to the user can be visual, auditory, or tactile.

- The level of feedback should be appropriate for the message it is trying to convey.

A simple change of background color on a display may indicate that the user has moved into a specific submenu, but a flashing, pop-up message may indicate a more important change of system status, such as a low fuel level. Auditory feedback can be effective in communicating important messages, because they can easily grab a user's attention even when the user is away

from the system. For example, changes in pitch, volume, or rate can indicate changes in the severity of a situation. Auditory alerts function well in conjunction with visual feedback conveying the same message. Presenting the information in both the visual and auditory modalities increases the likelihood that the message will be received and responded to in a timely manner by the user. This is especially important in space because the high levels of background noise may impede users' ability to hear an alert.

Tactile feedback can be used to signal the status of events to the user. This may be especially helpful when the other modalities are restricted, such as during ascent or descent. For example, if a button stays depressed, this state may indicate that the function is proceeding, and when it releases the function has stopped. Vibration may also be used to convey a message to the user, just as cell phones vibrate when a call comes in. Vibration can also alert the user to an approaching performance limit, such as occurs with a stick- or pedal-shaker in aircraft flight controls.

10.8.3 Timing of Feedback

- The feedback should be delivered to the user in a timely manner.

Table 10.8-1 lists recommended maximum acceptable system response times for feedback, adapted from MIL-STD-1472F (1999). Feedback must be delivered directly after the event to ensure that the user correctly associates the response with the input, and in time to allow the user to perform any needed adjustments and follow-on tasks. The word "event" here can take on different meanings depending on the circumstances. For example, for a crucial task such as firing a rocket, feedback may be given after each command line to ensure that the user is intending to perform this critical action. However, if the user is changing the status of a valve, the feedback may need to be provided only at the conclusion of the entire command. In a third instance, such as tracking a target, feedback should be continuous. The timing of feedback, either continuously or at the conclusion of a command, depends on the nature of the event and its consequences. Immediate feedback is also very important for preventing the user from initiating an action twice. If the feedback occurs long after an event, the user may believe that the event was not properly received and initiate it again. For some events this can have dire consequences, and it should be avoided through the use of prompt feedback. If there is to be a delay in system feedback greater than 2.0 seconds, the user should be given some indication that the system is processing the request. The indication can be in the form of a symbol (e.g., hourglass), animation (e.g., running list of dots..... or filling progress bar), or text message (e.g., "Processing...", "Please wait," "This request will take several minutes to complete. "). The primary goal is to inform the user that the system is not "locked up" or malfunctioning, but is processing the user's request.

The optimal timing of feedback is important in 1) delivering the desired information to the user and 2) preventing the user from initiating the action twice. Additionally, the timing of feedback is important for the speed of overall operations. If the feedback is slow, the user must wait between commands, slowing productivity and leading to frustration in the user. In some instances, it is helpful for feedback to repeat. For example, a safety-critical message may be delivered every 30 seconds until the problem is rectified. It is important to make the timing of this recurring feedback appropriate for the severity of the event. Critical alarms, such as fire alarms, should continuously sound until acknowledged by the crew. Noncritical messages may

be delivered less often. The timing of delivery is important because it must alert the user to the problem, but not be so frequent that the user becomes desensitized to it. Desensitization occurs when users stop responding to the alert because they have heard it too many times. Essentially they have begun to “tune it out.” Presenting unimportant or noncritical messages to the user at very short intervals will cause the user to become desensitized to them. Therefore, determining the frequency of the feedback is important to ensuring that the message is properly received.

Table 10.8-1 Maximum Acceptable System Response Times

Action	Maximum Acceptable System Response Time (s)
Indication of a discrete input – Snap feel, audible click, or associated visual or audio display	0.1
Display of information on crew request - Appearance of requested data value or display (does not apply to initiation of a complex process)	1.0
Appearance of menu upon selection	0.5
Display of updated data or state change	1.0
Feedback that a command is in progress, completed, or cannot be completed. Can be a text message, progress bar, or other visual indication.	2.0
Appearance of error message after an input	2.0
System Health and Status, operational mode	Available continuously or on request

Action	Maximum Acceptable System Response Time (s)
Indication of a discrete input – Snap feel, audible click, or associated visual or audio display	0.1
Display of information on crew request – Appearance of requested data value or display (does not apply to initiation of a complex process)	1.0
Appearance of menu upon selection	0.5
Display of updated data or state change	1.0
Feedback that a command is in progress, completed, or cannot be completed. Can be a text message, progress bar, or other visual indication.	2.0
Appearance of error message after an input	2.0
System Health and Status, operational mode	Available continuously or on request

10.8.4 State information

- The user should have access to the status of the system at all times.

It is important that the user know the state of certain processes to be able to determine the next course of action, and to avoid initiating a change of status if that change has already been made. The designer should consider the following three major design features: the type of status indicator, the method used to deliver that status information, and the timing or precision of the information delivery.

10.8.4.1 Types of Status Indicators

Many possibilities exist for the types of status indicators used to convey system information to the user. The most common types of status indicators on a computer include lights, selection (e.g., using highlighting, color, or handles around an object), accessibility indicators (e.g., when a button is available or able to be formatted, the font is bold and black, and when it is unavailable the font is gray), an indented appearance to buttons, and a check or dot next to an item.

10.8.4.2 Methods of Indicating Status

The most common methods of indicating status involve a visual change, text label or message, and/or auditory tone. Under most circumstances using one method of providing status information to the user is sufficient. However, situations may occur that require two forms of status indicators. When two forms of status indicators are needed, varying the dimension to which they are presented is beneficial. For example, in certain situations, providing a visual change and an auditory confirmation beep would be more beneficial than providing just a visual change. The number of status indicators needed for each status message needs to be evaluated when a system is being designed. Additionally, the user may request status information from the system. When the user is requesting information, the most salient way of delivering that information is through a text message.

10.8.4.3 Precision of Status

- The user should be provided timely and precise status information.

The information needs to be timely to prevent double actuation of a command, and precise to ensure proper user interaction with the system. For example, if the status information is delivered at some delay, the user may believe that the system has not received the command and thus issues it again. This double actuation of a command can have minor to serious consequences depending on the command delivered, and needs to be avoided. If there is to be a delay in notifying the user of a change in status, a message such as “Please wait” may be displayed in the interim to notify the user that the system is processing the request.

10.8.5 Research Needs

TBD

10.9 CREW NOTIFICATIONS AND CAUTION AND WARNING

An “auditory alarm” is an audio signal used for alerting or warning a user within a human-machine interface, while an “alarm” refers generically to either audio or visual cues. The use of auditory alarms in current Shuttle applications is reviewed in technical documents. Auditory alarms are part of the collective caution and warning system that consists primarily of visual cues (illuminated light displays and switches, an illuminated message on a dedicated matrix panel, or a text message on a CRT; Space Flight Operations Contract, 2004).

10.9.1 Auditory Alarm Functions

Auditory alarms have three primary functions:

Get Attention – Alarms indicate that a specific condition exists that did not occur previously and that now requires attention. This may include the corollary function of waking a sleeping crewmember.

Focus Attention – Alarms have a rudimentary function of stating, “Look over here at this specific visual display.” This is a form of “directed attentional shift” that is significant in the larger context of the cognitive challenge of fault management (Woods, 1995).

Define Level of Importance – Alarms relate the relative urgency of the alarm through the semantic content contained in the alarm type. The type of alarm indicates where in the hierarchy of possible auditory alerts the new alarm lies and how quickly crewmembers need to attend to the problem.

10.9.1.1 Levels of Alarm

The “class” of an alarm defines the level of importance. Three alarm classifications are presented below:

- Class 1 alarm – Emergency
- Class 2 alarm – Warning
- Class 3 alarm – Caution

These classes are described in Table 10.9-1.

Table 10.9-1 Alarm Classifications

Alarm Class	Definition of Condition	Examples of Conditions That Would Trigger Alarm
Class 1	Emergency – A life-threatening condition that requires an immediate and preplanned safing action to protect the crew	The presence of fire and/or smoke in a pressurized element A rapid change in O ₂ and CO ₂ partial pressure within a pressurized element The presence of toxic atmospheric conditions within a pressurized element
Class 2	Warning – A condition that potentially affects crew survival, and may require a predetermined action to contain the consequences	Loss of a system Loss of a system function Loss of insight into and/or control of a system function Accumulation of failures that jeopardize a system function Exceeding a predefined safety limit
Class 3	Caution – Conditions that are less time-critical but have the potential for further degradation if crew attention is not given	Heavier than normal consumable usage

The class 1-3 auditory alarms used on the Space Shuttle are useful reference points from which to discuss best practices in the development of future alarms for NASA applications. They illustrate a coherent, useful approach to alarms that nevertheless can be improved upon, given subsequent human factors research and the possibility of implementing superior alarm-generation hardware.

Four classes of alarms are used on the Shuttle and can be prioritized in ascending order as follows. These classes roughly align with the classifications in Table 10.9-1, with the addition of “class 0.” A “class 0” alarm visually indicates up and down arrows on the CRT display next to a specific monitored variable, indicating that it has exceeded its predefined upper or lower boundary limits. A “class 0” alarm has no auditory component. A “class 3” alarm is technically an “alert” and generates a steady tone of 512 Hz for approximately 1 second (this can be changed by the crew to longer durations, up to 99 seconds), along with an illuminated button and fault message on the CRT. A “class 2” alarm generates an illuminated text message on a dedicated matrix panel (panel number F7), and illuminates parameter lights on another panel (number R13U). The alarm consists of an alternating tone between 375 and 1000 Hz. It is silenced (“killed”) by pressing a master alarm switch.

Two types of class 1 “emergency” alarms are highest priority: (1) smoke detection and (2) rapid cabin depressurization. The smoke detection alarm on the Shuttle consists of a “siren” sound, i.e., a tone varied from 666 to 1,460 Hz and then back to 666 Hz over a 5-second interval. Smoke

detection lights are indicated on a dedicated panel (L1). The cabin depressurization alarm is indicated via a “klaxon” sound, consisting of two tones at 270 and 2500 Hz that are periodically iterated. Pressing the master alarm switch also silences these alarms. Under the current design, it is possible for all of the auditory alarms to sound simultaneously. (NOTE: An additional class 1 alarm has been implemented in hardware but not software for “toxic alert” on the ISS, meaning that the alarm is never annunciated under the current configuration). In general, the highest-priority alarm should take precedence over the lower-priority alarms.

Table 10.9-2 indicates the specifications for class 1–3 alerts (Space Flight Operations Contract, 2004). Note that the tolerances for frequency and timing are 10% of the specified value.

Table 10.9-2 Shuttle Specifications for Class 1–3 Alerts

Class 1 siren	Varying frequency from 666 Hz (± 66 Hz) to 1470 Hz (± 147 Hz) and return over 5 (± 0.5) seconds
Class 1 klaxon	2560 Hz with a period of 2.1 ms ON and 1.6 ms OFF mixed with a 256-Hz tone with 215 ms (± 21 ms) ON and 70 ms (± 7 ms) OFF
Class 2 tone	Alternating signal of 400 and 1024 Hz at a 2.5-Hz rate (i.e., 0.4 s duration per frequency)
Class 3 alert	Continuous tone of 550 (± 55) Hz

10.9.2 Design of Auditory Alarms

10.9.2.1 Auditory Alarm Sound Pressure Level

- An auditory alarm should be audible with a very high degree of reliability.

This typically requires the amplitude level to “penetrate” background noise. At the same time, alarms need to be conducive to effective fault management, and not merely audible. Thus, the challenge for designing a good alarm in terms of its level can be expressed simply as “not too loud, not too soft – but just right!” This becomes a challenging matter when listeners are at varying distances from loudspeakers, or are wearing hearing protection devices without headset delivery of sound.

In terms of signal detection theory, an auditory alarm should have the audibility necessary to achieve a 100% “hit rate.” This is usually a matter of calculating a signal-to-noise ratio based on previous research into auditory signal detection. Most auditory alarm engineering guidelines err toward making the level higher than might be predicted by auditory masking experiments (Robinson & Casali, 2003). However, if the alarm is too loud or too pervasive, negative effects on human performance can occur; from the perspective of effective fault management, a startle effect requires time for recovery (Patterson, 1982). Many alarms have a startling, excessively high level that is counterproductive from the perspective of human factors research; simultaneous alarms can exacerbate the problem.

A signal-to-noise ratio of 15 dB(A) is a commonly cited target signal-to-noise ratio for alarms, but this disregards the frequency content (spectra) of the alarm or the noise. International Standard ISO 7731:2003, “Danger signals for work places – auditory danger signals” examines the role of the spectral components of alarms with regard to masking in concurrent and adjacent spectral bands (ISO, 2001). Figure 10.9-1 is an example of a one-third-octave band analysis from ISO 7731:2003 that calculates the signal-noise ratio in greater spectral detail. The requirement states that the signal must be ≥ 13 dB relative to the masked threshold in one or more octave bands (Zwicker & Fastl, 1990). The masked threshold is modeled by allowing a contribution toward the masking level from adjacent bands of noise, as well as the frequency band that is concurrent with the alarm.

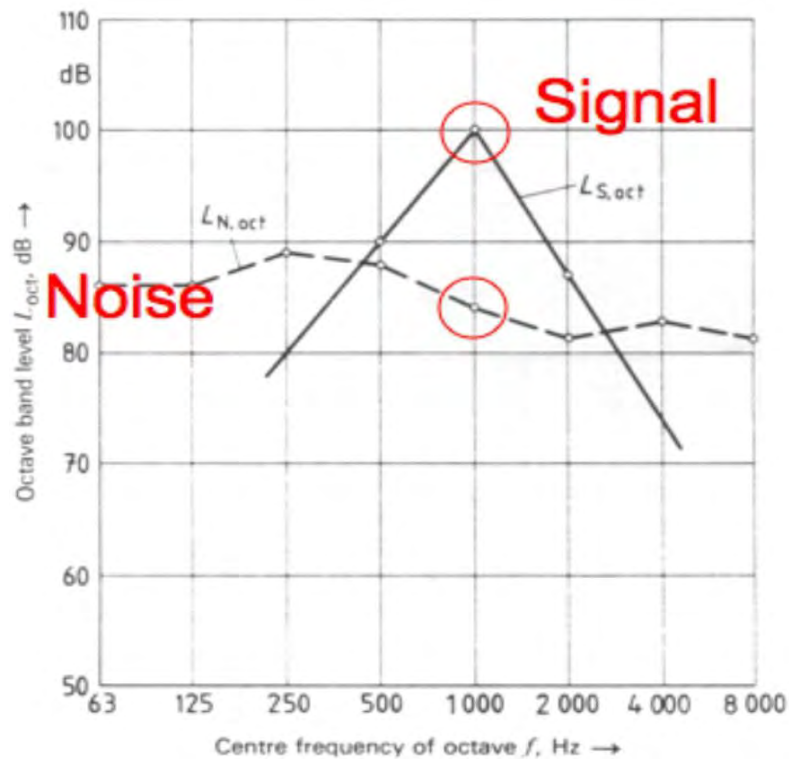


Figure 10.9-1 Annotated illustrative example from ISO 7731:2003. Abscissa indicates octave band center frequencies in Hz. Ordinate indicates octave band sound levels in decibels. Alarm signal level ($L_{S, oct}$: solid line) has a spectral component in the 1 kHz octave band that is 15 dB higher than the noise level ($L_{N, oct}$: dashed line).

From an engineering perspective, it might at first be considered naïve to design a very loud, startling auditory alarm, but these have certain useful applications. For example, building evacuation alarms are designed to be annoying to compel persons to leave the vicinity as quickly as possible. In this case, the message is “leave immediately,” and the listener does so because the alarm is loud and irritating. These types of auditory alarms are of course counterproductive to environments such as flight decks.

10.9.2.2 Auditory Alarm Frequency Content

For ensuring audibility, the frequency content of an auditory alarm is as important as its level.

- Auditory alarms should contain frequency components in the region of relative maximal hearing sensitivity, 0.2 to 4 kHz, which is the primary region of acoustical energy for speech sounds.

ISO 7731:2003 specifies that alarm signals contain frequency components of 0.3 to 3 kHz, and have sufficient energy from 0.3 to 1.5 kHz to accommodate high-frequency hearing loss or those wearing hearing protection devices. Patterson (1982) recommends having four or more spectral components that are harmonically related, to allow “fusion” of spectral components. He also specifies that the fundamental frequency (the first spectral component) be between 0.15 and 1 kHz. MIL-STD-1472F (1999) specifies frequencies of 0.2 to 5 kHz but with an upper limit of 1 kHz for distances greater than 300 m (985 ft) and an upper frequency limit of 0.5 kHz if there are partitions or obstacles between the signal source and the listener. These limits are appropriate because shorter wavelengths that correspond to higher frequencies can be blocked by solid objects, while lower frequencies can “bend” around them. Other standards are similar in terms of specified frequency content; for example, the Society of Automotive Engineers Standard SAE J994b-1978 (Society of Automotive Engineers, 1978) for backup alarm devices indicates spectral components of 0.7 to 2.8 kHz.

10.9.2.3 Auditory Alarm Discriminability: Typology and Temporal Pattern

What should an alarm “sound like” for a given context? People identify alarms on the basis of their frequency content and temporal pattern.

- An alarm should be easily discriminated from background noise and other types of signals.

For a specific context, it may be important to determine to what degree non-alarm auditory signals overlap with a potential alarm. For instance, if a fan has a constant harmonic tone that has significant energy at 1 kHz, an alarm with a constant tone may not be an ideal type of alarm, even if its frequency components conform to ISO 7731:2003 by being ≥ 13 dB over the fan’s tone.

- In an auditory display using multiple alarms, the alarms themselves should be easily discriminable.

The typology of an auditory alarm refers to the temporal aspects and frequency content of the sound “object” that gives it a specific semantic content. The typology of an auditory alert can be identified by using ecological references for determining an auditory alarm’s meaning and level of urgency. For example, the sound of a siren is a learned cultural reference that differs from region to region, but is easily identified. Research has indicated that the ease of recognizing an auditory alarm is driven partly by associations that people have learned between sounds and what they represent (Gaver, 1986; Stanton & Edworthy, 1999). The design of an auditory alarm system can take advantage of “known” alarm typologies. It is also useful in some cases to

associate the typology with a specific action. For instance, the rattling sound and vibration of a stick shaker in an aircraft during a stall alert is caused by the object that must be attended to. One researcher places alarms in four categories, “Siren – klaxon – horn – electronic.” Klaxon Signals LTD, a company specializing in alarms, indicates categories of “electronic sounders, sirens, buzzers, hooters, fire alarms and beacons” (<http://www.klaxonsignals.com>). The sound of alarms can be considered a subset of what Gaver (1986) has termed “auditory icons,” which can range from abstract to literal representations of sounds (e.g., a fire alarm being represented by the sound of something burning).

The most important aspect of alarm typology is that it allows ease of discrimination among a set of alarms that would be used in a human interface. The alarms must have an inherent means of conveying level of urgency and be easy to learn. Thus, the use of alarms that are already familiar to a user makes categorization and learning easy. For example, astronauts familiar with the caution and warning signals will make an easy transition to similar alarms that maintain the same typology of “siren, klaxon, and electronic tone.” On the other hand, the ability to learn and remember a set of abstract alarms is severely limited; Patterson (1982) set a limit of four alarms for easy acquisition, while learning with up to three additional alarms is far more difficult. In aircraft, the “attention-getting” component of some alarms is followed by and distinguished through the use of an “added” synthesized speech message. However, speech messages take longer to comprehend than an auditory alarm, and are more easily masked by background noise. Although speech can convey complex ideas that cannot be conveyed by a nonspeech auditory alarm, the chance for misidentification is far greater with speech auditory alarms than for nonspeech alarms.

Electronic (synthesized) tones have a far richer potential for differentiation than they once did because of the ease and economy of using sound-sampling techniques. It is potentially far easier now to create candidate alarms having more “discriminable” acoustic features. The use of distinct temporal patterns has been proposed as a means of conveying urgency and for aiding discrimination between multiple alarms (Patterson 1981). This method is effective because temporal pattern—the sequence of “on” and “off” iterations of the alarm sound—is easily heard and discriminated by a listener.

American National Standard ANSI S3.41, “Audible Emergency Evacuation Signal,” (ANSI, 1990a) recommends a specific temporal pattern of three “on” pulses, each with a one-second period, followed by 1.5 s of silence. ISO 1994, “Anesthesia and respiratory care alarm signals,” indicates two specific patterns, as shown in Figure 10.9-2. An alarm “burst” is formed by multiple pulses with a silent interval in between of 0.15 to 0.5 s, depending on the ranking of the alarm. Between each burst is a silent period, here termed the “inter-burst interval.” Such silent intervals allow time to think, verbally communicate, and take action in a constructive manner, compared to the counterproductive use of a constant alarm. For each specific application, a question remains of how much the inter-burst interval could be increased while retaining awareness that the alarm was still active.

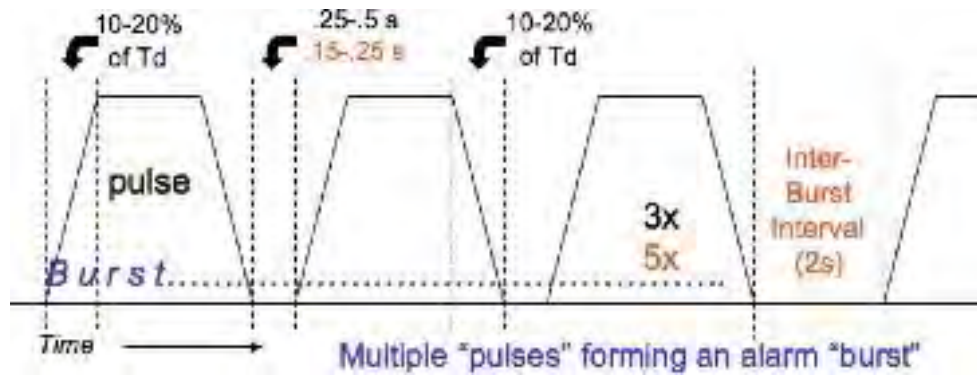


Figure 10.9-2 Pulses forming an alarm “burst” (ISO, 1994).

A note about discrimination is appropriate here and is based on an informal report that class 2 and class 3 alarms as heard on the ISS could be confused. The class 2 auditory alarm consists of an alternating low and high tone. When the class 2 tone is heard at a sufficient distance, e.g., within a different module, the upper tone is masked by shadowing effects, so that only the low tone is heard. This can be confused with the sound of the class 3 alarm, since they are not differentiated by temporal interval and in isolation the 375-Hz tone is not perceivably different from the 512-Hz tone. The use of distinct temporal patterns may help mitigate this problem.

Finally, ISO (2003) is the only standard that indicates a human-in-the-loop test should be conducted to ensure alarms are discriminable. A formal study using multidimensional scaling techniques would be the best means to determine the underlying perceptual scaling for differences between alarms.

10.9.2.4 Minimizing Auditory Alarm Startle Effect

Humans possess a startle reflex that is involuntarily activated by objects abruptly entering the visual space or by loud noises. Physiological responses include anxiety, arousal, and tightening of muscles. At the most basic level this is likely a hard-wired evolutionary adaptive mechanism that helps protect us from potential dangers in our environment. From a human factors standpoint, the effect of the startle reflex is counterproductive to effective fault management.

Two noise factors are responsible for activation of the startle reflex: 1) overall level; and 2) temporal transition of the amplitude envelope from the zero state to a maximum. The overall level can be mitigated as described in ISO (2003). An additional concept is the use of a “precursor” alert. The level of the alert is played –6 to –10 dB lower on its initial presentation than on successive presentations. This mimics the effect of hearing a gradually approaching emergency vehicle; sirens are far more startling when a person is standing near a vehicle that initiates the alarm than when the person hears the vehicle approaching from a distance.

Design of the alarm pulse can make the temporal transition of the amplitude envelope more gradual than an instantaneous onset. Figure 10.8-3 indicates the use in ISO (1994) of an envelope rise and fall time equivalent to 10 to 20% of the overall duration of the pulse. The effect is to cause a “fade-in” of the tone that helps to mitigate the startle effect. It should be noted that

several types of alarms, including the Shuttle depressurization class 1 klaxon and a fire bell, cannot be faded in using this method without significantly altering the timbre (and therefore the recognition) of the signal.

10.9.2.5 Consideration of Auditory Alarm Levels at the Ear

Sound levels cannot exceed 85 dB(A) during orbit or 115 dB(A) during launch or reentry. To maintain levels above a changing background noise level, it is possible to integrate systems that continually monitor the noise level and then adjust alarm levels to the target signal-noise ratio. When crewmembers are wearing hearing protection devices and helmets, alarms should be delivered via headsets, though not necessarily at as high a signal-noise ratio as from loudspeakers, since the position of the loudspeaker in relation to the ear is predictable. A rough estimate would be 50% of the loudspeaker level (about 6 dB above the background noise level). Under circumstances where this level would exceed 115 dB(A), the use of non-auditory means of alerts (e.g., tactile or haptic actuators, or only visual alerts) may be recommended to conserve hearing.

10.9.2.5.1 Design of Visual Alarms

It is often beneficial to accompany auditory caution and warning tones with visual alarms. The following are guidelines for visual alarm design and visual caution and warning systems based on SSP 50005:

- A master alarm light should be provided in each room (or compartment).
- Illumination of the master alarm light must indicate that at least one or more caution, warning, or emergency lights have been energized.
- Master alarm lights should have the capability to be energized simultaneously.
- Master alarm status lights should be visible from any location in the open volume of a module.
- Multiple methods should be provided for extinguishing signal lights:
- Restoration of a within-tolerance condition without remedial action or as a result of automatic switchover
- Correction of the situation as a result of remedial action by the crew
- Performance of some action by the crew that is directly related to the controls of the affected system or component. This action indicates one or more of the following:
- An acknowledgment of the occurrence of the malfunction
- The completion of indirect remedial action
- The shutting down of the malfunctioning system component
- The color of CWS indicator lights must conform to the following guidelines:
- Each color should always be associated with a single meaning. That color should always be associated with a single meaning within the same system.
- No more than nine colors, including white and black, should be used in a coding system.

- Color usage should be consistent across the system. The usage and meanings of specific colors is outlined in the “Visual Displays” section (10.6).
- Indicator lights must be at least three times brighter than the other indicators on the same panel.
- When flashing lights are used, their flash rate must be within three to five flashes per second with on and off times of approximately equal duration.
 - Flashing lights must illuminate and burn steadily if the indicator is energized and the flasher device fails.

10.9.3 Visual Versus Auditory Alarms

When is it appropriate to use an auditory alarm, as opposed to a visual alarm? Perhaps the most obvious function of the auditory alarm is to alert a person to inspect a visual display. Less obvious is the relationship between the alarm’s informational content and the preferred modality for communicating to a user.

There are some important differences between visual and auditory alarms from the standpoint of human factors and multimodal perception capabilities (Stanton & Edworthy, 1999). Auditory alarms are pervasive and independent of where the listener is in the environment, so long as the level of the alarm is audible. Visual alarms require the user to look at the specific alert to gain the meaning of the message. Because of these differences, auditory alarms can be used to guide attention to a visual alarm message. Auditory alarms can convey a specific message faster than a visual alarm. It is also possible to immediately convey an urgent versus a non-urgent meaning in an auditory alarm. On the other hand, the tradeoff is that the semantic content of an auditory alarm cannot be overly complex, and the order of messages is far easier to retain from visual information than auditory information. Finally, sometimes it is possible to ignore distractors (noise) in one modality to focus on the message in another modality.

From these perceptual performance differences, Table 10.9-3 can be derived to determine guidelines for when to use auditory and visual alarms.

Table 10.9-3 Guidelines for Using Auditory vs. Visual Alarms

Auditory alarm preferred for	Visual alarm preferred for
Simple message	Complex message
Short message	Long message
No subsequent recall of message	Subsequent recall of message
Immediate action required	No immediate action required
When visual system overloaded	When auditory system overloaded
Moving persons	Stationary persons

10.9.4 Research Needs

Further research is needed to examine the relationship between predicted responses for alarm typologies and subjective responses from nonprofessional subjects. The results can indicate the degree of predictability of responses, based on level of urgency via “post analysis” of the sounds used, and can narrow the number of stimuli to be evaluated in later studies involving crew or other domain specialists.

Important alerts should be given priority and the less critical alerts should be less frequent and/or less salient. When establishing the frequency of the alerts, it is important to keep in mind the entirety of what the crew will be experiencing at one time. Crewmembers on the ISS have commented that focus should be placed on determining priority and frequency of critical caution and warning alerts rather than intuitive low-level alerts. Crewmembers frequently reported that they became desensitized to the intended aim of caution and warning alerts when these auditory signals occurred too often.

10.10 ELECTRONIC PROCEDURES

An electronic procedures system (eProc) is a special task-oriented display system that should supply users (crewmembers or flight controllers) with all the information they need for either executing or viewing the procedure. Onboard procedures, which previously accounted for more than 100 pounds of launch weight per mission, have almost all migrated to electronic format, with the exception of a few emergency cue cards, which are still in paper form. In addition to saving very expensive and limited up mass, electronic procedures have the advantage of being easily modified and annotatable. They can even be integrated with the onboard command and control, and fault detection and annunciation systems. This integration allows for telemetry and commanding from within the procedure itself, which can offer many advantages in terms of reduced workload and task efficiency.

Consider the following information and guidelines when developing requirements for electronic procedures systems:

- The electronic procedure should display relevant telemetry and other cues (e.g., timers) inside the procedure, where appropriate.

This type of integration between the electronic procedure and system information provides greater crewmember situation awareness by providing data within the procedure that crewmembers are looking at during a task. With this type of implementation, crew can conduct a side-by-side comparison of desired and actual status of relevant system components while performing a procedural step.

- The electronic procedure should cue commands for the crewmember.

With the exception of certain safety-critical commands, the eProc should provide a visual cue to the command or telemetry on the system display for crewmember execution or acknowledgment. This capability will reduce the need for the crewmember to manually navigate to multiple system displays to complete a procedure.

- The electronic procedure should indicate execution or viewing status through the use of visual cues, such as scroll bars, symbols, and text background or foreground colors.

For error-free procedure execution, it is important that the crewmember be able to see at a glance, which steps have been executed vs. which step is the current step. The crewmember also needs the capability to view prior and future steps in a procedure.

- The electronic procedure should be integrated with fault detection and annunciation systems.

Integration with these systems will provide the capability for assistance to the crew in selecting the correct procedure to respond to a Caution & Warning event.

- The electronic procedure should be integrated with the crew timeline.

Integration with the crew timeline will provide increased efficiency – the capability for the crewmember to easily navigate between the timeline and the appropriate procedure.

- Different types of procedures, including checklist, malfunction, and rendezvous checklist, should be supported.

To optimize screen real estate and minimize crew workload, each type of procedure may require a different rendering format. For example, the checklist may have to be displayed sequentially, as a series of pages, with each page containing a series of steps, whereas a malfunction procedure may require only the relevant step(s) to be displayed, based on operator input or the relevant vehicle data. The exact number of display formats required should be determined based on hardware (display unit) constraints and operations concepts.

- The electronic procedure should have a table of contents or similar method to access procedures exclusive of the timeline. Procedures should be organized logically (e.g., by subsystem, phase of flight, and/or criticality or frequency of use).

The table of contents or method to access procedures will provide crew with increased efficiency in accessing procedures.

- The electronic procedure display should be data driven and should accept data (procedures) update during operation (in-flight). The version of the procedure should be clearly indicated.

Depending on the concept of operations, the crewmember should be notified when procedural data have been updated. In most cases, a visual alert (e.g., popup dialog) is sufficient.

- The electronic procedure should allow for links between procedures. The system should provide a clear indication for a link (e.g., underline, color, text). The system should retain information about the completed steps and current step on all procedures as the crew moves between procedures using links.

Procedure links allow crew to navigate between associated procedures. When crewmembers return to the original procedure from which they linked, they should not have to remember which procedural step they were on.

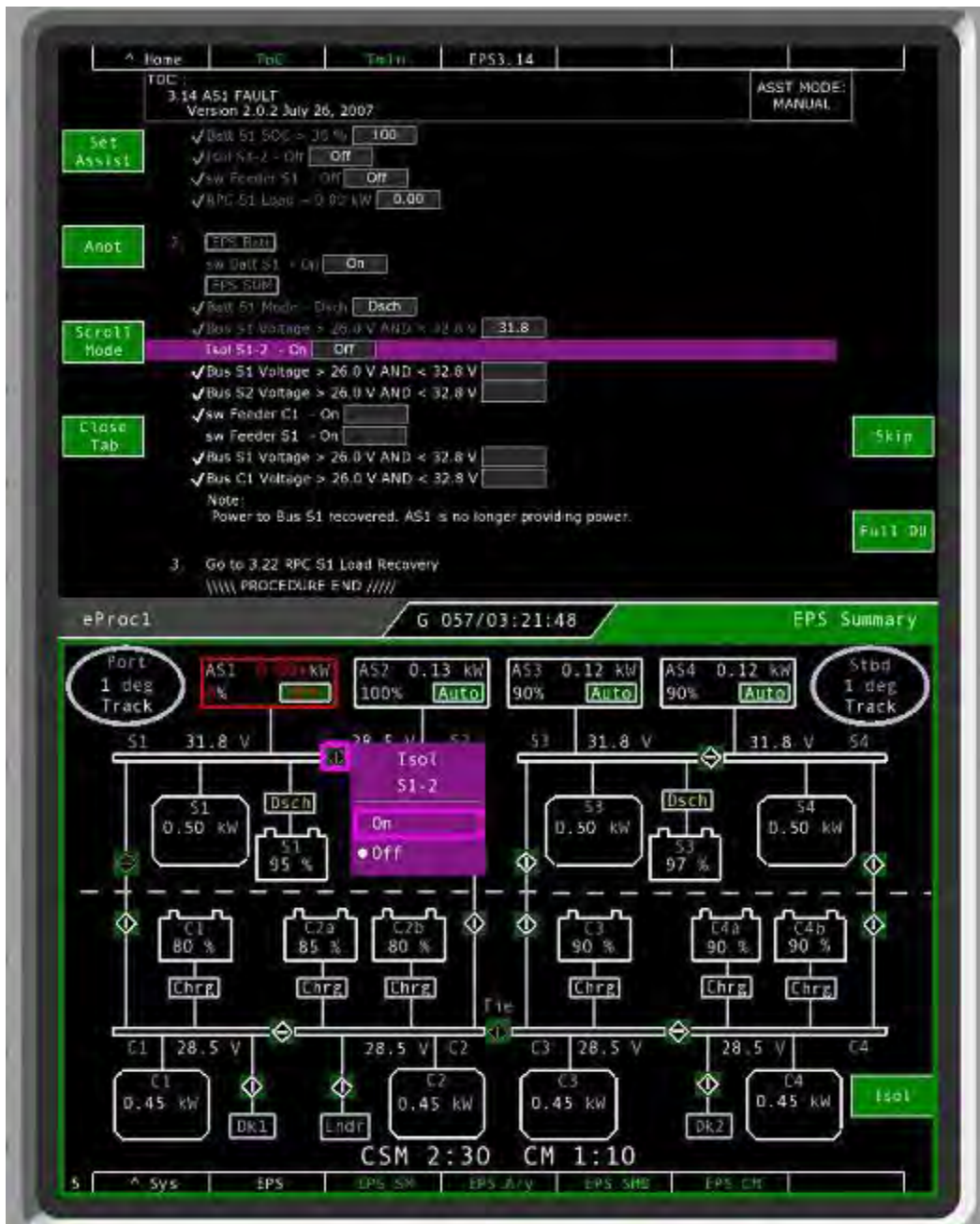


Figure 10.10-1. An example of an integrated electronic procedure (upper display) that can control an onboard display (lower display). In this example, the appropriate command popup (magenta menu on lower display) is auto-cued by the electronic procedure (upper display).

10.11 **HARDWARE LABELS**

Labels aid in quick identification of items, interpretation of procedures, and avoidance of hazards. Labels make an interface easier to understand, remember, and recognize. Procedure and task completion times depend greatly on labeling. Good labels help avoid errors, reduce processing time, and make the interface more intuitive.

Factors that should be considered in the design and application of labeling and coding include, but are not limited to, the following:

- Degree of accuracy of identification required
- Amount of time available for recognition or other responses
- Distance at which label material must be read
- Level and color of illumination
- Criticality of the function labeled

10.11.1 **General**

- All controls should be labeled, with the exception of controls that are frequently used or have unique design features that would prevent them from getting confused with other controls (e.g., steering wheel of a car).
- The label should appear as close to the control as possible, and should be readily identifiable as the specific label for that control.
- A label should not appear between two controls, unless those controls have the same function, as the user will be unable to determine the control to which the label applies.
- The best placement of a control's label is directly on, above, or to the left of the control, and consistent implementation of this rule will allow the user to quickly extract which label belongs to which control. See section 10.11, "Hardware Labels."
- Labels should show units of measure.

Critical accidents have occurred due to confusion over units of measure (e.g., loss of NASA's Mars Orbiter in 1999 due to metric/English units confusion; Stephenson, 1999).

Below are descriptions of several different methods of labeling for crew interfaces.

- Silk-screened labels – Markings that are silk-screened with ink onto hardware
- Decals – Peel-off labels, with adhesive backing, that are applied onto hardware
- Ink-stamped labels – Markings stamped with ink onto the hardware
- Engraved or etched labels – Markings carved onto the hardware surface
- Placards – Cards that are inserted into transparent pockets on the hardware

10.11.2 Standardization

- **Labels should be consistent and standardized throughout a spacecraft or system.**

Standardization allows the user to command different processes or hardware with the same knowledge. It would be inefficient for the system to require different skills and knowledge levels from the user to operate at different levels or to perform different processes.

Standardization helps to keep error rates down. Task-switching studies have shown that when people switch from performing one task to another, response times slow and error rates increase. Therefore, switching from one format to another would result in such performance decrements. If all systems use the same configuration, crewmembers will be able to use their experience on their dominant system to access information on a system that is rarely used. This allows crewmembers to have quick access to information and controls without learning or searching, which are both time-consuming processes. Creating a spacecraft or system-wide labeling plan during the design phase can help with ensuring consistency throughout the system.

- Labels and procedures referring to the labeled items should be consistent.

This aids in ease of use and helps decrease the probability of error.

10.11.2.1 Nomenclature and Syntax

- Nomenclature and syntax should be consistent throughout the spacecraft and systems.

When a word is used to describe an item, the user learns the association between that word label and the meaning it is intended to convey. If this association changes or deviates at any point in the user's interaction with the system, the user will become confused about the operation of the item. The change can occur by either changing the label or attaching a new meaning to the label. Either of these outcomes will confuse the user, and should be avoided.

10.11.2.2 Abbreviations, including Acronyms

- The use of abbreviations (including acronyms) should be minimized, and they should be included only if users are familiar with them.
- All abbreviations should be defined, and definitions should be readily accessible.
- Abbreviations should be written in title or lowercase text, whereas acronyms should be written in all caps.
- Punctuation of abbreviations (e.g., periods as in a.m. and p.m.) should be omitted except when it is needed to prevent misinterpretation.

10.11.3 Identification

- Labels should be designed so that crewmembers can locate and identify the label in a timely manner under all conditions of intended use, including suited operations.
- Label wording should be simple and familiar.

Complex labels may take additional time to recognize, identify, and interpret, thus increasing task time and the chance of errors.

10.11.3.1 Item Identification

The presence of labels allows easy acquisition and interpretation of item function.

- Items should be assigned names that are functionally relevant and meaningful to users.

The label informs the user of the name and function of the corresponding item. This eases the memory demands on users because they are not required to remember the function of the item. Labels also help users find the items they are looking for. Labels are coded by color or location, and these codes act as cues to users when they are searching for a particular item to perform a task.

10.11.3.2 Interface Identification

- Labeling should be used for identifying connection ports and connecting ends of items, such as cable or hose ends, using unique coding to assist with correct connections. Identifying fasteners, mounting locations, or alignment should also be considered.

10.11.3.3 Operation Identification

- Labeling should be used to identify states or operations such as switch positions, control actuation directions, or operations of controls not intuitive to users by visual inspection.

This can prevent inadvertent, incorrect operation that could pose a hazard to the user, or potentially damage equipment. Examples of non-intuitive operations may be a nonstandard rotation of a knob to open or close something, or a compound operation (e.g., pull and turn).

10.11.4 Avoiding Hazards

The labeling of items helps users avoid hazards. It does this in several ways. One way is by displaying to the user the proper name and function of the item, thus helping to prevent unintended actuation of the wrong item. Another way labels help prevent hazards is by indicating to the user a possible hazard or hazard-prevention device.

- Any label indicating a possible hazardous condition or operation should clearly identify the hazard, and the action to avoid that hazard (e.g. Caution: Hot Surface. Do Not Touch Without Gloves).
- Labels should use colors and symbols to indicate additional information, such as emergencies, or how components attach.

Some labels require specific coloring to indicate their function or possible hazard; for example, items used in an emergency situation are required to have diagonal red and white stripes on the label or directly adjacent to it. This color coding quickly indicates to the user that these items are aids in an emergency situation. Additionally, wires and cables are labeled with information indicating to the user which end attaches to what input unit. This will help prevent the user from inadvertently plugging a cable into the wrong location and possibly will help avoid a hazard.

10.11.5 Visual Properties of a Label

Each label must be easily recognizable and distinguishable from other labels by properties such as color, contrast, size, and shape. Other properties such as letter size and font require consideration also.

10.11.5.1 Readability and Legibility

- Labels should be readable and legible.

Readability refers to the style or manner of the text, in terms of how easy it is to understand.

Labels must be readable by the crew from their operating locations and user orientation.

Legibility refers to how easily or comfortably text can be read. It is based primarily on the size and appearance of the text.

- Abstract symbols should be used only when they have an accepted meaning to all intended readers. Common, meaningful symbols (e.g., % or +) may be used if they are compatible with the procedure software specifications.
- If dual languages are necessary, English should be used first with lettering at least 25.0% larger than the secondary language.
- If space is limited, the primary and secondary language can be of equal size, but should be no smaller than a 10-pt font.
- If space allows, a 12-pt font is recommended for reading at an arms-length distance.
- Text should be as concise as possible without distorting the intended meaning or information.
- Text should convey verbal meaning in the most direct manner by using simple words and phrases.
- Labels should be clearly legible under normal conditions as well as under conditions of high vibration, motion, and varying illumination.

The following are some common findings of legibility research (also refer to section 10.3.2.5):

- Lowercase text is more legible than uppercase text.
- Regular upright fonts are more legible than italics.
- Contrast is important and a black font on a yellow or white background is the most effective.
- A black font on a white background is easier to read than a white font on a black background.
- Letter spacing and word spacing also affect legibility.

10.11.5.2 Orientation of Labels

Label orientation affects recognition and identification of the label.

- **Labels should be shown in a horizontal orientation.**

In some cases space is limited on displays or interfaces and a different orientation would fit better. However, one should be careful about using orientations other than horizontal. Studies have shown that horizontal labels are easier to read than marquee-style labels or even rotated labels (90° left or right, see Byrne, 2002; Sándor et al., 2008). These results indicate that, whenever possible, designers should use horizontal orientation. The orientation of the label should allow it to be readable from the most likely orientations of crewmembers.

10.11.5.3 Location of Labels

Labels must be located so that they are visible to crewmembers in the normal position of access or operation.

- Label location should be consistent across a system to facilitate easy recognition.
- Labels should be positioned close to the item they are labeling.
- Labels should normally be placed above the controls, displays, or other items they describe.
- When a panel is above eye level, labels may be located below if label visibility will be better and if it is clear that the label is for one particular control, display, or connector.
- Labels identifying display functions should be placed on the panel above the displays.
- Placement of labels on curved surfaces should be avoided when possible.
- On overhead panels, markings and labeling should be oriented so that they appear upright when observed from the operational viewing angle.
- Markings should be spaced to avoid a cluttered appearance.
- The arrangement of markings on panels should be such that errors of association are unlikely.

This can be accomplished through techniques like spacing, consistent location, and/or separation by grouping lines.

10.11.5.4 Alignment of Labels

On a display, three methods are frequently used to align text: (1) aligned to the left margin, (2) aligned to the right margin, or (3) justified, in which the text has a uniform alignment to both margins. Also, in some cases when a display contains long labels, they may be wrapped to save space.

- When labels have similar lengths, left alignment should be used.
- When labels have mixed lengths, right alignment should be used.

Results from research studies (Sándor et al., 2008) suggest that wrapping increases recognition and response times, and should be avoided whenever possible. Also, left alignment is

recommended when labels have similar lengths, but when there is a mix of short and long labels, right or data alignment is more advantageous.

10.11.5.5 Color

Color is a useful way to help inform users of item function. Designers should keep some important factors in mind when choosing a label color.

- Only one color should be used for each function.

When the same color is used for two different functions, the functions are not easily distinguishable to the user.

- The number of colors used for each label should be limited to nine (including black and white).

It is difficult to distinguish two labels with too many colors from each other because the user must evaluate the presence or absence of certain colors, or the pattern of the colors. This requires cognitive calculation on the part of the user and should be avoided in favor of a more simplistic design.

- The lighting conditions of the environment in which the label will be viewed should be considered when choosing the color combination. Colors that require full lighting to be distinguishable from each other should be used only in locations that will always possess full lighting.
- For locations, such as the cockpit, in which crewmembers may need to interact with labels under conditions of low light, the colors should contain high contrast and be easily distinguishable from each other.
- To avoid confusion for color-deficient observers, the color green should not be used if the color scheme uses more than six colors, and red and green should not be used within the same complement.
- The background color of the label should be considered to ensure that the other colors on the label have sufficient contrast with the background to be distinguishable.

Some labels require specific coloring to indicate their function or possible hazard.

The following conventional uses for the most common colors should be considered:

- Red – Emergency-use items, warning, and master alarm lights; safety controls; critical controls requiring rapid identification; emergency shutdown; control panel outline of a functionally critical emergency nature
- Yellow – Caution; safety controls associated with emergencies of a less critical nature
- Yellow with black stripe – Immediate access; exit releases
- Orange – Hazardous moving parts; machinery; start switches
- Green – Important and frequently operated controls having no urgent or emergency implications

- Green (Sage) – First aid and survival
- Blue – Advisory (not recommended for general use)
- Purple (Magenta) – Radiation hazard
- White – Advisory (for trans-illuminated devices only)

10.11.6 Research Needs

TBD

10.12 INFORMATION MANAGEMENT

Information management is the act of performing functions with electronic data, including data input, organization, internal processing, storage, dissemination, and disposal. An information management system therefore includes all hardware and software to support these functions. Information management functions are performed by crew and ground teams using input devices in conjunction with displays on display devices. This section contains guidance related to information management and the use of electronic data.

10.12.1 General Considerations

An information management system should:

- Be easy to use
- Provide data with relevance, timeliness, and accuracy to the user as needed
- Allow easy updating of, transmittal of, and access to data
- Reduce or eliminate the need for supplementary materials (such as hardcopy data for procedures), management material (e.g., document restraints, paper filing systems), and associated office supplies (e.g., paper, markers)
- Use standard nomenclature
- Have a logical and easily navigated system for accessing information
- Be compatible with all potential user demographics (considering a range of user skill levels, user knowledge, etc.)
- Be operable under all conditions of potential workplace environment
- Integrate well with input and display equipment

10.12.2 Types of Information

- The information management system must be consistent with other interfacing systems.

The information management system should consist of the following:

- Operational procedures
- Contingency procedures
- Safety hazard data (hazard sources, special procedures for safe operations and hazard recovery, and hazard incident log)
- System maintenance and troubleshooting procedures (e.g., replacement and repair log and procedures)
- System maintenance log
- Payload procedures

- Payload data collected
- Environmental status and trend data (see chapter 6, “Natural and Induced Environments”)
- Crew medical histories
- Inventory management data
- Entertainment media (e.g., movies, photographs, books)
- Vehicle system operational health and performance and trend data
- Additional data provided may include
 - Schematics
 - Mission event log (including system maintenance history)
 - Recent onboard video and still imagery
 - Training materials and records
 - Video logs
 - Other personal information

Hardcopies of critical procedural information – hardcopy backup materials for all emergency procedures of the spacecraft for continued crew safety, rescue, or escape, particularly for scenarios where the system’s operation may be degraded due to low power or loss of power

10.12.3 Crew Operability

- The system should provide methods and tools for the crew to perform information management functions.

Information management functions may need to be performed at times when only the crew can perform them, for example when there may be a lack of communication with the ground. Examples of information management functions include graphing system trend information, composing and sending electronic mail, searching for and within procedures, and viewing training materials. Information management functions do not necessarily reside on the flight avionics system. The system should be designed for high usability under a variety of scenarios, including the range of environmental conditions in which the user may need access to the data, such as emergency conditions (e.g., poor lighting, high vibration).

10.12.4 Data validity

In any system, it is important to ensure that all data being displayed to the operator are accurate. If there is a reason for the data to not be trusted (i.e., checksum failures on transmission, nonsensical or off-scale values, or lack of received data), then telemetry needs to be flagged in some way. There are many cases where making decisions based on old or invalid data would be worse than not having data at all, so care needs to be taken to ensure that the operator is aware of any questionable data on a display.

Missing Data is commonly indicated by graying out a field, making the text values change in color, or adding a symbol (such as an *) to a data item. This indication is especially important for

telemetry with discrete states, as those items may not change frequently, so that section of the display will always appear static. Any “stale” data on a page should be clearly marked when presented to the operator.

Questionable data can result when a checksum or parity check for a data message fail, or when an incomplete data message is received. In these cases, it may still be possible to extract telemetry from the message. However, resulting data values may be incorrect, thus an operator should be alerted to the fact that this telemetry is suspect. A similar condition can occur if there is a sensor failure (or disconnected signal wire) which causes a reading to be an impossible (or unlikely) data value. In this case, an off-scale high (or low) value for the sensor may be sent, rather than the actual value. When telemetry is received at high frequency, questionable data can also simply be suppressed/dropped/omitted, and the display is updated during the next cycle with valid data. However, if a persistent communication problem exists (or the message frequency is low), then there may be a desire to see suspect data, rather than nothing at all for those data fields. As a result, where questionable data are presented to the operator, the data need to be clearly indicated as such.

- Questionable, stale, or missing data should be indicated as such through use of visual coding (e.g., color, symbol, background fill).

10.12.5 Data Availability

10.12.5.1 Data Rate

- The system should acquire and provide data at a rate that enables the crew to perform tasks effectively and efficiently (including monitoring system status).

Different classes of data must be gathered at different minimum rates to be useful to the crew. For example, navigation data might be gathered once per second, payload data once per minute, and routine medical data once per day.

- Data display rates should not exceed the user’s ability to perceive and act on the information being conveyed.

10.12.5.2 Data Fidelity

Data fidelity (accuracy, precision, reliability, latency, resolution) is essential for proper vehicle functioning and for the crew to make timely and correct decisions, particularly in critical operations.

- The data must have an appropriate level of fidelity for the crew to perform tasks.

10.12.6 Data Distribution

10.12.6.1 Locations of Data

The crew may choose to perform information management functions (both entry and retrieval) at various locations throughout the vehicle. For example, a crewmember reading an online maintenance schematic may choose to move away from a crewmember having a private medical conference.

- The system should provide the crew with data to perform tasks at each workstation where those tasks can be performed.

ISS and Shuttle Program history has shown that wireless connectivity is desirable, since it reduces clutter within the vehicle and improves mobility and productivity. The incompatibility of wire clutter with launch and entry activities (such as emergency egress) makes a wireless solution especially desirable.

The ISS and Shuttle programs have also shown that wireless connections can be unreliable and hard to troubleshoot; therefore, they are not desired as the sole option for critical functions. It is important to have a backup wired distribution system.

10.12.6.2 Information Capture and Transfer

- The system should provide a method for the crew to capture and transfer information from any display in a format that provides mobility and the ability to annotate.

The use of alternative technologies such as digital paper, personal digital assistants, and tablet computers would allow annotations to be shared more easily with Mission Systems, but this requirement does not necessarily preclude the use of printed material.

10.12.7 Data Backup

10.12.7.1 Form of Backup Data

- Since information management systems operate on electronic hardware, the system should provide a mechanism for backing up data on a regular or periodic basis.

Data may be backed up within the system but on another data storage device (such as another hard drive or storage device on the system), transmitted to remotely located storage devices (e.g., ground-based or alternate space-based systems), or printed as a way of having hardcopy backup. Printed data backups are recommended for highly critical information that might be needed in the event of a total systems power failure. Alternative electronic storage mechanisms may be used for data that might be needed at some later date, but that is not needed immediately or does not need to be accessed during a power failure. Remote data backup is recommended for all data but should be used only for data that would not be needed immediately.

10.12.7.2 Automated Backup

- The system should provide an automatic backup function for safety-critical data.

Backup functions are best automated to prevent inadvertent loss of critical data and the unnecessary expenditure of time.

10.12.7.3 Manual Backup

- The system should provide a selective data backup function.

It is not necessary to back up all data automatically; however, the crew may choose to back up selected data.

10.12.7.4 Manual Data Restore

- The system must provide a “data restore” function.

Backup data must be able to be restored to support emergency and critical operations independent of external support (e.g., loss of communication).

10.12.8 Information Management System Requirements

- Workstations and portable devices containing accessible electronic information should provide the following:
 - Security
 - Protection of sensitive data (e.g., password protection, encryption)
 - Electronic privacy – a secure viewing environment for electronically displayed private information such as medical data and e-mails
 - Transmission security
 - Sender verification – ability to add digital signatures to all database traffic between spacecraft and with the ground, to allow the receiving system to verify the sender’s authenticity
 - Portable data storage – portable data storage devices for transporting data between information access locations and points of use
 - Remote management – ground access to perform all onboard database functions without crew intervention
 - Information Management Using Printed Paper – The following design criteria pertain to printed paper (hardcopy) information media and associated hardcopy equipment and supplies:
 - Equipment restraints in 0g – provide a means to restrain documents, loose sheets of paper, writing implements, and supplies (e.g., tape, scissors)
 - Writing / working surfaces – provide fixed or portable writing and working surfaces
 - Writing instruments and supplies – provide writing instruments and supplies required for documentation update (e.g., paper, scissors, and tape)

- Stowage of writing instruments, supplies, and documents – consolidated stowage for writing instruments, supplies, and documents in locations that are easily accessible
- Printing equipment, paper, and associated supplies – provide easily accessed equipment and supplies for data transfer connections, power activation, operation, resupply, and inventory

10.12.9 Electronic Communications

- The information management system should provide the following capabilities for communicating electronically:
- Messaging – the ability to exchange information electronically (e.g., by e-mail) with personnel on the ground
- Attachments – the ability to attach electronic files (e.g., documents, photos, video, sound files) to communications
- Encryption – to prevent security breaches, eavesdropping, and tampering with sensitive or private data
- Sender verification – the ability to add digital signatures to all electronic communications between spacecraft and with the ground, to allow the receiver to verify the sender’s authenticity
- Private personal communications – the ability of crewmembers to exchange information of a personal nature (e.g., medical information or family communications) in such a way that only the intended recipients (e.g., flight surgeon or family member) can read the message or view any attachments

10.12.10 Research Needs

Further research on unique information management needs of long-duration space flight is recommended, particularly with regard to data integrity, hardware reliability, usability under various environmental conditions, and balancing attention and reaction-time requirements.

10.13 AUTOMATED SYSTEMS

User interfaces with automated systems require special consideration for design and operations. This section discusses incorporating automation into system design, as well as specific considerations for user interfaces with robots, including mobile systems.

10.13.1 Automation

Automation is the replacement of manual operations by automatic, usually computerized, methods that take the place of, or mediate, human perception, action, or decision-making. This section provides general guidance for introducing automation into system design.

10.13.1.1 General

The benefits of reducing workload and training, and increasing situation awareness make automation in space exploration essential. Poor automation design, however, can lead to a reverse effect – increased workload and training, reduced situation awareness, and accidents (Miller & Parasuraman, 2007). In system design, important tradeoffs need to be made between both division of tasks potentially performed by the human and the machine and the level of automation for each task. The decision to automate depends on several criteria, including the number of tasks, and the required safety, accuracy, speed, and duration of those tasks, as well as the limitations of human operators to effectively meet these criteria. Although this section applies to the design of all types of automation, a special emphasis is on robotics. Over time, increased importance has been placed on developing human-robot teams. Optimum use of robotics is especially necessary to support long-duration and deep-space missions. In these scenarios, use of automation will increasingly be required as the frequency and duration of periods of without the possibility of communication with ground control escalate (Ferketic et al., 2006a). Additionally, as the roles for robots expand, and as they begin to work both independently and in groups (Steinfeld et al., 2006), it will become more and more important for crews to be able to interact with many different types of robots—an actuality that heightens the need to standardize interfaces for human-robot interaction (HRI) when possible (Ferketic et al., 2006b).

The model of Parasuraman, Sheridan, and Wickens (Parasuraman et al., 2000) illustrates the need to consider both the division of tasks mentioned above (referenced as types of automation in the model) and levels of automation, and gives an appreciation for the scope of the assignment. The following subsections will address both of these aspects of providing automation in space systems and the attributes of interfaces necessary for integration with the human user.

10.13.1.2 Human / Machine Task Division

Designers must determine how tasks will be divided between humans and machines. The goal is to achieve the most effective overall human-machine system, making the best use of the capabilities of both.

- In dividing tasks between humans and machines, the following factors should be considered:
- Task analysis
- Functional analysis of the tasks and subtasks
- Human capabilities and limitations
- Machine capabilities
- Human / machine integration capabilities
- In general, automation should be incorporated when human capabilities are insufficient or can be better used for other tasks.

Along with tasks requiring faster or more accurate computative skills than the human possesses, automation is most appropriately used to accomplish “dull, dirty or dangerous” chores (Ferketic et al., 2006a). Examples of applications well suited for automation include the following:

- Complex tasks (e.g., precision flight-path management)
- Hazardous tasks (e.g., monitoring gas levels)
- Impractical tasks (e.g., extended extravehicular activity)
- Time-consuming and repetitive tasks (e.g., system monitoring)
- Compensating for reduced human performance (e.g., reentry after 0g adaptation)
- Extending human abilities (e.g., crew assistant satellites)

In addition to parsing the functions appropriate to the human and the machine, the designer should consider that task allocation is a dynamic undertaking that may need to change several times throughout the performance of a mission. One of the important factors in function allocation is effectively and appropriately keeping the human involved –a lesson learned in aviation, as well as in space exploration, over the past several decades. It is clearly established that the use of automation in aerospace vehicles has greatly improved the effectiveness of the pilot by performing many time-consuming duties, such as navigation, system monitoring, and fault diagnosis, as well as complex jobs, such as those involved in high-speed maneuvering and precision flight-path management. Nevertheless, experience indicates it is valuable to keep the human in the loop, because computer-based decision-making cannot match the cognitive ability of the human brain to adapt to changing situations. Unlike humans, computers have virtually no inductive or creative capacity and usually cannot adequately handle the unexpected. Furthermore, if the human is not involved at all, it will be difficult to intervene if automation fails due to lack of situation awareness.

The importance of having the capability of the human to intervene in automation has been evident from the beginning of human space flight and exploration. John Glenn manually piloted Friendship 7 during his second and third orbits because of difficulties with the automatic pilot controls, which failed due to apparent clogging of a yaw attitude control jet. The crew of Gemini 8 prevented their own deaths through creative supervision and overriding the automation when their thrusters incurred electromechanical failure. Also, if the Apollo 11 Moon landing had been automated, the crew's safety may have been compromised. Because of the intervention of the human pilot during landing, an unexpected boulder field in the landing zone was avoided and a safer site chosen. Better sensors and navigation tools will be available in the future, and will allow increased automation of functioning in real time; however, human decision-making will likely remain a necessity for dealing with new, unforeseen obstacles.

Human constraints, both physiological and cognitive, should be considered to ensure that the operator can achieve adequate task performance. Due to adaptation to 0g, almost all astronauts experience some level of sensory disturbances, primarily visual and vestibular, that can affect their ability to perform complex and demanding tasks. Degraded physical ability may become even more problematic after long-duration missions such as the exploration of Mars. The addition of automation to reduce the amount of pilot control needed should be considered in such cases.

Automation can enhance human skill. For example, computers are necessary when a task requires rapid and accurate computations; thus, automation should be used during high-precision flight operations, such as atmospheric entry where heat and g-load damping are vital. However, the capability for the human operator to override automation and retain vehicle control must be provided during critical flight phases, such as the terminal landing phase, when the human can safely assume control.

10.13.1.3 Levels of Automation

Once an understanding of the mission tasks to be automated is reached, an initial assessment of allocation of tasks between human operation and automation is accomplished. An informed decision can be made about the level of automation to be used and the amount of control necessary. A spectrum of automation levels in terms of control is illustrated by the following diagram:

Manual → Teleoperated → Supervisory → Automated

At one extreme, no automation is used, giving the human operator full control of a given task. Some aspects of the physical or information properties of the worksite might be displayed to the user, but no electronic or mechanical operative technologies would be introduced to replace or augment user activity. This form of “null” interface works best in situations in which the task demands are consistent with typical human capabilities and there are no significant safety issues. Toward the middle of the spectrum are functions that require increased automation because of the complexity or criticality of the task, but require varying degrees of human input. At the other extreme is a fully automated system that, once initiated, independently performs its task without human supervision.

If the automated operation is accomplished without crew oversight, it is considered to be autonomous. Autonomous activities may be required during long periods of communication delay. Such delays can be on the order of 30 minutes to 1 day and conceivably longer on deep-space missions. Similar to the criteria for selecting automation over human operations, the determination to design an autonomous, versus remotely operated system depends primarily on the following factors (Sheridan, 2002):

- the time interval separating successive interactions by a user
- the risk associated with a user being physically present at the work site
- the complexity of the required user interaction
- the appropriateness of typical human sensorimotor and cognitive abilities to the required task

Levels of automation can be viewed in terms of the human either sharing or trading control with the machine per Verplank's notions of extending, relieving, backing up, or replacing the human capability (Hansman & Cummings, 2004). Regardless of where on the spectrum the control falls, the designer should consider that although automation can be used to reduce the human operator's workload, the capability for the human to intervene at any level and assume manual control is necessary. Sheridan (2002) specified eight levels of automation as listed in Table 10.13-1.

Table 10.13-1 Levels of Automation

Levels of Automation	
1.	The automation offers no assistance; the human does it all.
2.	The automation suggests alternative ways to do the task.
3.	The automation suggests one way to do the task and:
4.	It executes that suggestion if the user approves or
5.	It allows the user a restricted time to approve before automatic execution or
6.	It executes the suggestion automatically and then necessarily informs the user or
7.	It executes the suggestion automatically and then informs the user only if asked or
8.	It selects the method, executes the suggestions and ignores the user.

From Sheridan (2002).

There is no need to automate all stages of a process to the same level. In air traffic control, for example, all of the data acquisition and much of the analysis and display filtering is fully automated and happens without user input, but the decision-making and implementation remain largely user driven. In this way, the best of automated and user-controlled systems can be combined.

- In addition to the general considerations for division of tasks between human and automated operations, specific factors affecting decisions about the level of automation include these:
- Time pressure

- Update capability
- Required precision and accuracy
- Cost-benefit tradeoffs
- Sheer number of elements of the required task
- Amount of interaction between elements
- Possibility of counterintuitive nature of required actions

10.13.1.4 **Biasing Effects on Control**

At each level along the control spectrum, the effectiveness of the human-machine interaction (HMI) will be influenced by several biasing factors. These factors are particularly applicable to HRI. Most acute among those factors is communication between the human and the machine. Communication is affected by delay, jitter, and bandwidth, and can greatly enhance or inhibit performance of both the human and the machine (Steinfeld et al., 2006).

Delay, also known as *latency* or *lag*, is the time difference between transmission and reception of a message and can be a determinant for the degree of autonomy possible or required. The most obvious delay determinant is distance. For example, a delay of 3 seconds has been the norm when communicating by radio waves between Earth and the Moon, and, depending on orbit distances, a delay of approximately 10.5 and 21 minutes between Earth and Mars. As mentioned earlier, deep-space missions will incur even greater delays. Generally, if continuity of action is desired, more delay will require more automation and machine autonomy over the delay period. *Jitter* is the difference between the transmission interval between two messages and the reception interval between the same two messages. It can greatly affect synchronization of data packets and, therefore, the effectiveness of the HMI. Since bandwidth refers to the capacity of the communication channel to carry data, limitations in bandwidth may cause data alteration or loss, and affect the accuracy and fidelity of the data exchange (Steinfeld et al., 2006). Bandwidth will affect all levels of automation control.

In addition to communication factors, the level of automation must account for location factors within the machine-operator environment. For example, HRI takes place in one of three relative positional situations: proximate (side-by-side), remote without significant time delays (abbreviated as remote), and remote with significant time delays (Ferketic et al., 2006b). Local tele-operation can be accomplished effectively with robots in close proximity because the human does not have to adapt to significant time delays (Ferketic et al., 2006b).

Another factor affecting HMI and, thereby, determination of automation level is the response capability of the machine and the operator. Machine capability is determined by characteristics such as intrinsic system lag (data processing time) and update rate (the rate at which data is displayed to the user). Similarly, the human user's capability is affected by any number of performance-shaping factors, which can include operational constraints, physical and environmental attributes of the workspace, complexity and repetitiveness of the task, proficiency and currency, and psychological and physiological stressors (Steinfeld et al., 2006). Each of

these effects must be taken into account in assigning the appropriate level of automation to the task and the requirements of the interface control.

10.13.1.5 The Need for Effective Crew Interfaces

- Automation should be provided when crewmembers cannot reliably and safely perform assigned tasks.

The human's superiority in maintaining or acquiring situation awareness is particularly important during emergencies and for critical off-nominal tasks, and history has shown that the flight crew can increase the probability of mission success. However, taking advantage of human adaptability requires effective interaction with the machine. In addition to being available to respond to hardware failures and unanticipated natural events, a human can overcome many latent errors in hardware and software design if proper attention is paid to the human-machine interface (Hammond, 2001).

The human-machine interface – or, in this context, *crew interface* – is any part of the system through which information is exchanged between the crewmember and the system (e.g., displays and controls). It is important to note that crew interfaces remain very important for the control of even highly automated devices that normally run without any crew interaction.

- Automation interfaces should enable the operator to understand exactly how and what was done by the automation and how successfully the task was accomplished.

Crew interfaces for low-level interaction with highly automated systems are also needed to help crews maintain low-level control skills as backup for automation failures.

A key feature to address in developing crew interfaces is the capability for the automation to be engaged and disengaged at both predictable and unexpected stages of an activity. Enough information displays and control inputs need to be available for human users to take over or relinquish control at all appropriate times. An example of the need to gracefully enter and exit automation comes from the deberthing of the Hubble Space Telescope when it was placed in orbit in 1990. When using the semi-automated resolved control mode to lift the telescope directly out of the Shuttle bay, the remote manipulator system (RMS) operator noticed that its movement was not straight up and the telescope was in danger of hitting the sides of the bay. He solved the problem by disengaging the automation that supported the resolved control mode and using the much more manual mode of joint angle control to safely deberth the payload. Significantly, his crew interface allowed this step downward in level of automation because it supported the information flows that the less automatic mode required.

Clearly, interfaces to future remote, autonomous systems must allow users to adjust the level of automation through which they wish to act so as to increase the variety of possible contingency operations. However, low levels of automation must not be provided as an option if testing and verification show that crewmembers cannot reliably and safely accomplish mission goals at those reduced levels. The design of the interface must be tailored to the appropriate level of automation.

An interesting example of a control task that might initially seem excessively complicated and that could alternatively have been approached through a higher level of automation, such as shared control, is the operation of the one-manned version of Deep Ocean Engineering's Deep Rover submersible (Figures 10.13-1 and 10.13-2). The crew interface for Deep Rover provides for the control of up to 13 degrees of freedom—a daunting task that might suggest the need for a great deal of automation. Microswitches on the control seat arms detect vertical, fore-aft, and rotational motion to control the vertical and forward thrusts and horizontal orientation, respectively. Two-axis, force-sensitive joysticks mounted at the end of each arm, combined with switches, allow control of the endpoint of each manipulator with up to 5 degrees of freedom, though some of these were locked for most operations (Ballou, 2007). The result is an effective, cost-efficient system using manual control of its complex mechanization.



Figure 10.13-1. Deep Rover submersible.



Figure 10.13-2. Deep Rover Control Seat with sliding armrests for vehicle control and two-axis force-sensing control sticks for manipulator control.

10.13.2 General Crew Interface Design Rules for Automation

Eleven useful user-interface design rules may be abstracted from the viewpoint of user needs being the general guides for automation design (Norman, 2008). The rules apply particularly to automatic systems in which user interaction is highly mediated. User interaction is through controls and displays physically remote from the actual site where the physical interaction that they control takes place. The first five rules (Table 10.13-2) address attributes the designer should instill in the interface.

Table 10.13-2 Rules for Designing Crew Interfaces for Automatic Systems

- 1. Provide rich, complex, and natural signals.**
- 2. Be predictable.**
- 3. Provide good conceptual models.**
- 4. Make the output understandable.**
- 5. Provide continual awareness without annoyance.**

From Norman, 2008.

Rule 1, to provide rich, complex, and natural signals to users, addresses the fact that interfaces to newly automated systems often remove important, incidental sensory information provided by predecessor technology. Background information such as the vibration and sound of jet engine turbines accelerating, notifying the pilot of the degree of increasing thrust, provides an informational context that helps users understand the physical context of actions they may take. Consequently, automated systems need to provide replacement cues. A typical example is an audio click triggered when a software-created switch is toggled on a graphical user interface (GUI). This sound replaces the older switch feel that confirmed closure when it was operated. Interfaces can detect a variety of signals from users. These signals can reveal the users' intentions or needs. Stress detected in voice commands, for example, could signal the need for help menus to be offered. Eye movements to look at a switch might predict crew operation of the switch.

Rules 2 through 4 are interrelated. They capture the need for a user of an automated system to have an overall conceptual model. An example of such a model would be the desktop metaphor for the common GUI. Systems incorporating logical and common metaphors are predictable and understandable without instruction. Users easily deduce, for example, that moving a file icon into a storage device icon causes a file transfer, and moving one into a "garbage can" causes file deletion. Capitalizing on this type of customary interpretation is useful for standardization among interfaces.

Rule 5—to provide continual awareness without annoyance—requires the designer to accurately presuppose what a user is expecting after interacting with a system. A crew interface must register crew input and provide feedback about what action could or needs to be taken next. Crew input must be acknowledged, and, if the processing will require significant time, the expected completion time and state of activity must be signaled. The progress bar used to give feedback during file transfer is a classic example of this form of feedback. Tognazzini (2008) notes in his design guidelines that such continual feedback is essential if the initiated process will consume more than 2 seconds. A reciprocal set of rules (Table 10.13-3) may be conceived as an admonition for the machine.

Table 10.13-3 Interface Design Rules for Automatic Systems from the System's Perspective

Rules for Systems in Their Interaction with Users
<ol style="list-style-type: none">1. Keep things simple.2. Give users a conceptual model.3. Give reasons.4. Make users think they are in control when they do control.5. Continually reassure.6. Classifying crew behavior as "error" can obscure design flaws in the automation itself.

Although it deals with simplicity, rule 1 is not simple to implement because of the system's context or cultural setting; nonetheless, through utilization of the interface, the user's actions

should be easily understood and accomplished. Conceptual models noted in rule 2 are also connected with perceived simplicity, since complexity largely arises when users are unable to develop an overall model of how the interface works. The essential design problem is consistent communication of the conceptual model to the user and how to implement it. The design metaphor is usually intended to exploit the users' common experience; but this intention is intrinsically cultural and depends on the designers' sharing common, relevant experience with their intended users. Consequently, designers need to explicitly develop the conceptual model they wish users to adopt and directly communicate it in introductory instructions.

Rule 3's recommendation to give reasons for actions taken or expected by the system is more securely universal than the others. It makes sense to keep the operator informed, and arbitrary or capricious actions by the machine are usually exasperating. However, explanations need not always be presented. If overly frequent, they can easily become intolerable. Conversely, providing a means to access information when it is needed builds user confidence. Effective application of this principle has been pursued with automated information (expert) systems since the 1970s, when intelligent medical advice systems, such as MYCIN, were developed to provide explanations of suggestions for antibiotic therapy (Buchanan & Shortliffe, 1984).

Implementing rules 4 and 5—giving users the sense of, and continually reassuring them that they are in, control—can take many forms, such as the aforementioned progress bars used during file transfer actions on personal computers. However, providing that sense of control to the operator deserves more comment. Although it is certainly true that a user's sense of control is critical for his or her acceptance of innovative technology, mismatches between perception of being in control and reality need to be avoided to preclude potential disaster. Confusion in pilots' understanding of the various flight control modes of Airbus aircraft have led to a number of crashes due to divergence between assumption and actual possession of control authority. In some instances the automation led the pilots to believe they could accelerate the aircraft normally when, in fact, their current control mode precluded the expected acceleration. In those situations the aircraft "thought" it was preparing to land, and, therefore, the pilot's pushing the throttles forward did not produce the expected increase in speed (Degani, 2004). On the other hand, being in control also means that the action of the system is expected, feedback is provided to human input, and the human has good situation awareness of how the integrated system performs. Rule 6 of Table 10.18-3, identifying error and allocating blame, highlights the need to accurately assign responsibility when a failure occurs during use of automated systems. If the human operator is too quickly blamed when the root cause of the problem is in the design of the automation, both immediate and long-term corrective action can be jeopardized.

As the above rules are applied to designing crew interfaces with automated systems, a final attribute is worthy of consideration. That characteristic could be termed "expressiveness." Expressive interfaces are not necessarily easy to use initially, but with training can become extraordinarily powerful, especially in an environment requiring adaptation. Their development is connected with the especially difficult problem of transitioning a user from one level of automation to another and with the need for rich system feedback.

A comparison of the original failed Newton handwriting recognition system with that subsequently used on the Palm Pilot identifies this need for system errors to be understandable and to support user adaptation. The successful Palm Pilot recognition system was an expressive

interface. It was initially somewhat harder to use than the alternative keyboard entry system, but it provided significant long-term benefits. Those benefits were realized because the recognition errors it made were comprehensible to the users, who were then able to modify their handwriting for better recognition. Such characteristics of crew interfaces would be especially helpful in deep-space missions where terrestrial assistance will be limited and infrequent.

10.13.2.1 Implications for Automation Tasks and Crew Interfaces for Robots

The terms “robotic” and “robot” are used in the context of task-oriented, mobile systems. In addition to the universal tenets described in the preceding sections, robotic operations hold some unique implications for automation in space. The tasks robots will likely perform include the following (Steinfeld et al., 2006):

- Navigation – determining where the robot is located and where it needs to be next, how it will travel to that next location, and how it will overcome obstacles and hazards en route.
- Perception – establishing an operating context through sensing, interpreting, and sharing environmental data.
- Management – coordinating activities of both humans and robots to ensure “having the ‘right’ agent at the ‘right’ place at the ‘right’ time.”
- Manipulation – interaction with the environment to include classic grasping, as well as pushing, dropping off cargo and personnel, and other actions accomplished through determining what, how, and how well a job is done.
- Social interaction – accomplishing activities that imitate human interaction by collecting, interpreting, and using data for applications such as transportation, medical care, entertainment, and modeling human intelligence.

In meeting these task challenges, the designer should consider the levels of automation and autonomy needed and the appropriate human interface to produce effective human-robot interaction in the remote robot environment.

10.13.3 Limitations of Automation

Although automation can be a necessary and useful tool, the technology has limitations, including these:

- Reliability – System design and material durability are crucial to dependability.
- Trust – Mistrust of the automation by the user results in inefficient use of the technology.
- Trust will be in proportion to the reliability of the system.
- Overtrust – High system reliability can lead to overtrust and result in slow detection of failure (vigilance problem), lack of situation awareness (intervention problem), and loss of skill (loss of confidence and actual skill) to perform without the automation.
- Workload and Situation Awareness – Sometimes the automation is reduced to the point of being too low and leads to loss of arousal and situation awareness, effectively

removing the human from the loop. These conditions set the stage for excessively high or impossible workload levels when automated systems fail.

Automation leaves two tasks for the operator:

- 1) to monitor the system to ensure that it works properly, and
 - 2) to take over from the system if it fails to work properly. The latter task can involve both troubleshooting and failure recovery, which are not necessarily connected to each other.
- Managing these tasks poses the following difficulties for the operator:

- Monitoring difficulties – Automated systems tend to have poor integrated feedback. Monitoring a machine that supposedly does a better job than the human can be difficult or impossible in the absence of knowing the correct behavior of the machine. In addition, ergonomics of the work environment plays a large role in the effectiveness of human monitoring of highly automated systems (Parasuraman et al., 1996). Providing optimum conditions for monitoring can be challenging in space.
- Vigilance – Accomplishing the process of paying close and continuous (sustained) attention while watching for something rare to happen can depend on time available, alertness, and expertise.
- Difficulties with taking over – It can be difficult to determine when to take over, achieve seamless transfer of authority, and cope with the unusual circumstances that require assuming manual control.

By taking limitations into account, designers can optimally use automation to enhance productivity, safety, and effectiveness of space missions.

10.13.4 Research Needs

TBD

10.14 MOBILE SYSTEMS

User interfaces with mobile systems consist of the physical and informational elements of manipulators or vehicles with which crewmembers interact. The informational aspects of these interfaces are generally common to other computer-based media, including other automated systems, and will not be addressed here; but the physical aspects of the interface with a mobile system can be unique and deserve special emphasis. Most noteworthy about these physical aspects is the fact that mobile systems require user interfaces with numerous constraints, since they not only make *informational* “contact,” but also make distinctive *physical* contact with their human users. This section discusses guidelines and considerations for designing within these constraints.

10.14.1 Definition of Terms

Mobile systems – rovers, robotic systems, mobile assistants, and maneuverable vehicles that are manipulated or spatially navigated by their users in space or on planetary surfaces.

Mobile systems are usually thought of as remotely controlled devices, but some specialized mobile systems are designed to work closely with their human counterparts, whereas others are user-carried and can make close physical contact with their operators (i.e., mechanical space suits and exoskeletons). For example, Robonaut is a dexterous humanoid robot that resides aboard the ISS and acts as an astronaut assistant (Figure 10.14-1)



Figure 10.14-1 Robonaut. Source: robonaut.jsc.nasa.gov

The Berkeley Lower Extremity Exoskeleton consists of a backpack and a pair of highly modified electrically powered boots that enable a user to carry heavy loads over long distances. (Figure 10.14-2.

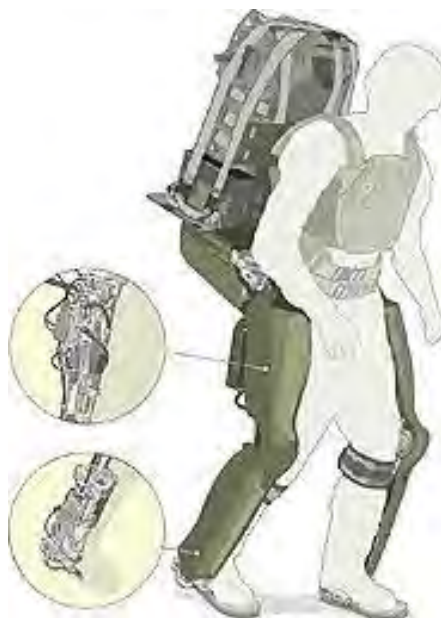


Figure 10.14-2 Berkeley Lower Extremity Exoskeleton. Source: Dr. Kazerooni, University of California at Berkeley (Kazerooni, 1990).

Autonomous mobile systems – mobile systems that can operate without human intervention.

Semi-autonomous mobile systems – mobile systems that operate with various degrees of human intervention and levels of automation.

Regardless of the level of autonomy, all mobile systems require a means for human-user interaction. Fully autonomous systems exchange information with humans through a user interface. Only interfaces with autonomous systems that are mobile will be considered here.

Teleoperation and telerobotics – remote operation of robotic systems by extending a person’s sensing and manipulation capability across a distance. This distance leads to a time delay (also termed *lag* or *latency*) between user input and machine action, and may be categorized according to the distance between the operator and the robotic agent, as follows: (Figure 10.14-3)

- Direct view – essentially no delay. (Note: The term *remote control* is sometimes reserved to describe situations in which the human operators have direct visual view of the worksite.)
- Remote view with short, insignificant delay
- Remote view with significant delay

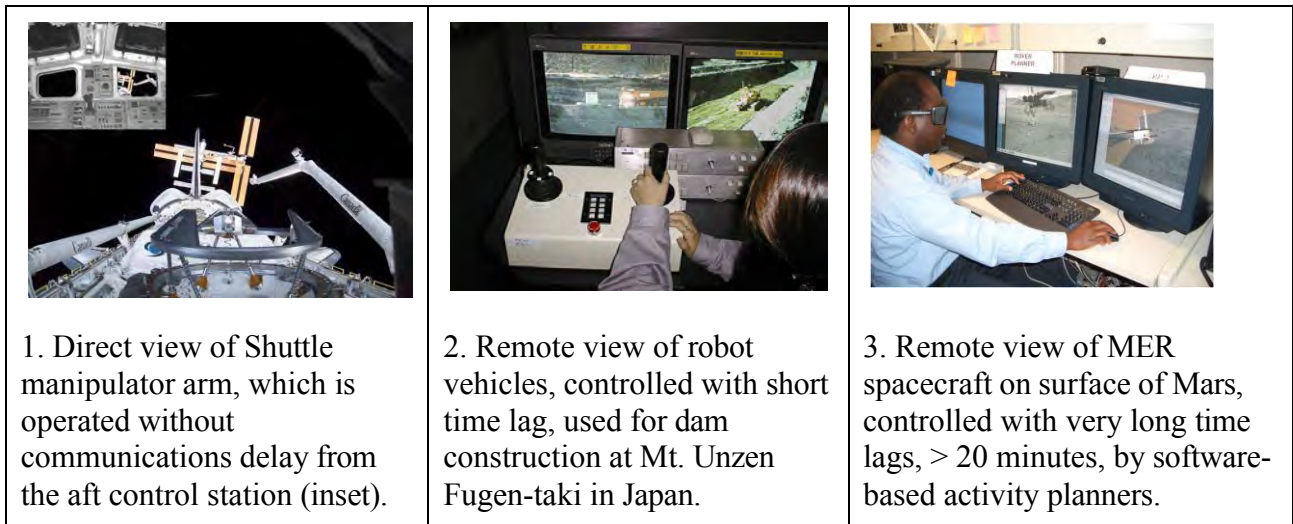


Figure 10.14-3 Categories of teleoperation.

10.14.2 Scope of Capabilities for Mobile System Interfaces

User interfaces enhance both the machine’s and the user’s capabilities to work efficiently to complete a task.

Space flight telerobotic tasks may vary widely, ranging from dexterous manipulation to large-area vehicle navigation. Consequently, these tasks require a large range of autonomy and dexterity. The required interfaces could range from multiple degrees-of-freedom, anthropomorphic master-slave manipulators to computer hardware and software systems that

enable point-and-click area navigation. Clearly, a user interface standardized for one of these classes of tasks would not be appropriate for the other. For example, force reflection could significantly benefit dexterous manipulative control for “peg in the hole” tasks (Hannaford, 1989), whereas it would have negligible impact on surface traversal planning.

Since they may be managed in unusual gravitational environments and unusual atmospheres, user interfaces to be operated inside spacecraft or on planetary surfaces have several obvious environmental differences that should be considered. In addition, they may be operated by users who can be significantly encumbered by gloves and position restraints, or by the debilitating effects of long-term space flight.

10.14.3 Similarities with Other User Interfaces

User interfaces to mobile systems have many of the same issues as conventional interfaces. These include considering sensory, perceptual, sensorimotor, cognitive, and social factors for successful system use.

Defining the properties that an interface needs to possess requires analysis these factors. This kind of analysis of user-system communication channels is captured in Figure 10.10-7, which describes the multimodal control loops present in virtual-environment systems. Though Figure 10.14-4 was developed to illustrate virtual-environment interfaces, it also pertains to spatial information flows in other interfaces. The channels represent the possible sensory modalities that could serve as output from the simulator and input to the user, as well as output from the user and input to the simulator. The properties of the communication channels in Figure 10.14-4 do not represent generally optimal values, but rather values that in at least one implementation have proven to support a useful interface (Ellis, 1994).

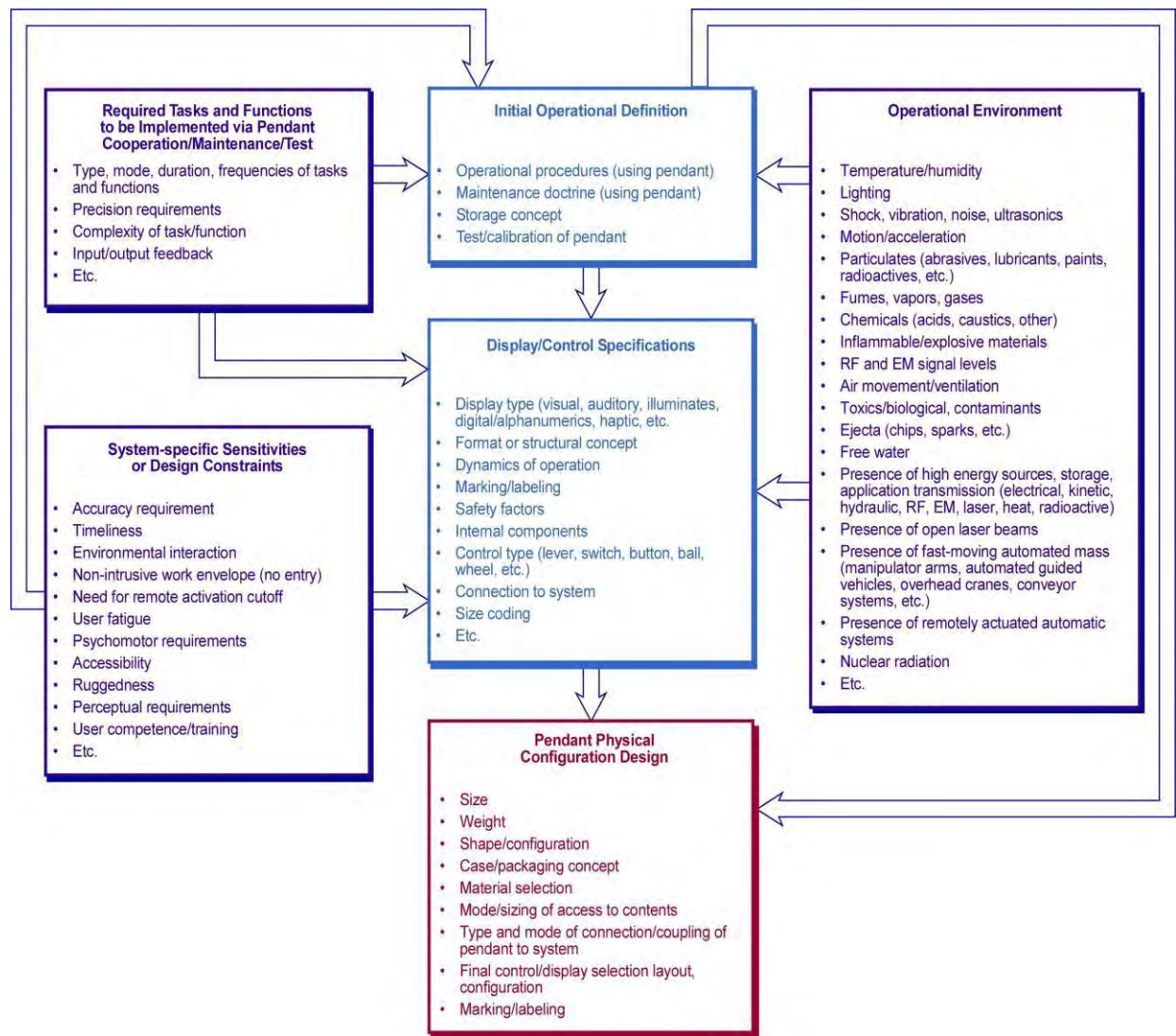
Although the properties in Figure 10.19-4 were specifically selected to describe communication channels in personal or vehicle simulators, they could be applied equally well to teleoperation interfaces. In such applications the properties should serve as estimates for the sensory and motor capabilities of generalized user interfaces for remotely controlled mobile vehicles.

Transmission Delay	Bandwidth	Resolution	Dynamic Range	Signal/Noise
DISPLAYS				
Visual				
<u>Monocular</u>				
20 – 100 msec	20 – 100 Hz	2' / pixel within 5° central vision	8-bit gray scale/color 60° field	25:1 contrast ratio
<u>Stereoscopic</u>				
100 msec	0.1 – 5.0 Hz	2' / pixel within central vision	30° binocular overlap; 2° disparity range; 0.1 – 6.0 meter/angle convergence	120:1 disparity ratio
Haptic				
<u>Tactile</u>				
5 msec	0 – 10 kHz	10-100 micron vibration; 1-2 mm spatial resolution	8-bit	200:1 RMS ratio
<u>Kinesthetic/Force</u>				
20 msec	50 – 100 Hz	0.1 N	20 N at DC to 1 N at 10 Hz; 6-bit; 1-10 cm	64:1 RMS ratio
Audio				
<u>Sound</u>				
1 msec	20 Hz – 20 kHz	Frequency: 0.02-3.0 Hz; Power: 2 dB	16-bit; 60 dB	40:1 RMS ratio
<u>Directional Sound</u>				
50 – 500 msec	3.0 – 6.0 Hz	Relative Direction: 1° at 5° C.E.P.; Absolute direction: 20° – 30°	4π steradians	20-30:1 solid angle ratio
<u>Vocal (Synthetic Speech)</u>				
10 – 100 msec	1.5 – 2.0 words per sec	90 to 95% recognition in 50,000 vocabulary	Potentially unlimited	N/A
CONTROLS				
Manipulative (Mice, Joysticks, Pedals, Trackers, etc.)				
10 msec	3.0 – 10.0 Hz 100 Hz for force-reflection	0.2° Joint angle 1-4 bits/DOF (discrete control); 10 bits/DOF (continuous control)	Range: Exoskeletal Limb Motion 20 N at DC to 1 N at 10 Hz	25:1 contrast ratio
Vocal (Speech Recognition)				
1 – 2 sec	1 – 2 words per sec	<<5% probability of misrecognition	20,000 words	25:1 contrast ratio

Figure 10.14-4 User-interface information channels.

Communication requirements of the interactive tasks to be supported need to be analyzed before an interactive, remote, mobile system is designed. The analysis is accomplished by identifying the sensory modalities to be used by the operator, along with the delay, bandwidth, resolution, dynamic range, and signal-to-noise level required of the integrated user-system. This approach will enable designers to determine the practicality of the proposed system. It also may lead them to select alternative sensory modalities or motor responses if the original choice does not match user capabilities to system requirements.

Industrial robotics is a source of common experience relevant for remote, autonomous interfaces that might be used in space missions. Figure 10.14-5 contains an extensive list of considerations for designing a control pendant (a handheld terminal used to control robot movements within a defined space) for an industrial robot. These aspects of design for an Earth-based mobile machine can easily be applied to user interfaces for mobile space systems.



NOTE: (Adapted from Fig A.1, ANSI / RIA 15.2-1-1990)

Figure 10.14-5 Human factors guidelines for developing an industrial robot control pendant.

10.14.4 Significant Aspects of User Interfaces with Mobile Systems

- Several features of user interfaces should be considered when designing mobile systems: presence, frame of reference, latency, sensory conflict, reduced sensorimotor coordination, reduced productivity, and the visual-manual aspect of tasks.

10.14.4.1 Presence

Presence is the sense of physically being in a real environment while actually experiencing it virtually or remotely. A unique feature of a user interface with a teleoperated mobile system is the sense of remote presence, or even of dual presence, that can arise as a result of interaction with a remote site over a low- latency communication path. Remote presence, or telepresence, is the users' sense that interaction has been adjusted for user control, although that control is constrained by the users' range of motion and kinesthetic sensitivity and the precision and range of motion required at the remote site. When these aspects of interaction are well designed, users can develop the sense that they are physically present at the remote site. If high levels of presence are desired, direct interfaces that use little automation should be incorporated. These types of interfaces are the most flexible and allow exploration systems to benefit from the physical or virtual presence of human users.

10.14.4.2 Frame of Reference

A key element of the sense of presence is the users' ability to understand the frames of reference in which they visualize and control the remote system and visualize and control its environment. These frames of reference may not be the same. For example, operation of the Space Shuttle Robotic Manipulator System (SRMS), or robotic arm, is achieved by controlling the arm from the aft middeck, but with views from the end-effector camera.

It is critical for the user to understand the geometric relationship between different reference points and the relationship between reference points and the user's own body. It is equally critical for the designer to provide a means of bringing about that understanding and to not exceed human limitations on compensating for misalignments of reference frames. One countermeasure to misalignment problems that occur primarily in egocentric view frames is to provide an additional "bird's eye" overview of the work site. This view provides users with global spatial cues to adjust for difficult views that are seen through an egocentric camera. The natural intuitiveness of such an "outside-in" versus "inside-out" perspective has been shown in aircraft flight-attitude instrumentation (Cohen et al., 2001). Shuttle RMS operators often have the benefit of a window view of the worksite, which adds to situation awareness.

Another technique for managing difficult egocentric views, as might be seen from a camera mounted on a remotely operated vehicle, is to be sure some of the vehicle structure, or at least a graphics element that visually behaves like the structure, is visible within the frame. Such presentations allow the user to understand the rotation between the camera axes and the vehicle axes.

Rotations between the camera and vehicle axes can interfere with the user's geometric interaction with the vehicle. Provided that visibility is sufficient, a direct view of the vehicle at the work site is the best way to provide the necessary overview. Not only is a direct view important for interaction with a remote vehicle, but a direct view of other users who may be cooperatively controlling a single vehicle, or a separate cooperating vehicle, has been found to be useful. Inter-user visual contact allows users to better understand the timing and intention of others in ways not easily supported by purely audio communication.

Lastly, in a microgravity environment, counterpressure against operator restraints provides tactile cues to enhance identification of reference frames, similar to the way gravity produces tactile pressure cues.

Since multiple, simultaneous frames of reference need to be managed, mode shifting and unambiguous cueing for each control frame of reference is needed; what is logical in one frame of reference may be counterintuitive in another. User interfaces must be designed to enable quick and accurate shifting of the user control frame of reference and allow the coordination of multiple simultaneous frames of reference.

10.14.4.3 Latency

A major characteristic of interactive remote systems is latency, or time lag between user input, system response, and subsequent observation. This delay is determined mostly by distance, but can also be affected by communication link capability or intrinsic mechanical properties. System latency produces three major interrelated negative effects on interface users:

- Sensory conflict
- Reduced sensorimotor coordination
- Reduced productivity

10.14.4.4 Sensory Conflict

Sensory conflict between visual, vestibular, and tactile cues can cause spatial disorientation and motion sickness and can be particularly troubling in space operations. Latency can act to aggravate these normal reactions to conflicting physiological stimuli by further decoupling visual and other cues.

It is difficult to generalize the possible effect of latency because it depends on the type of motion to which users are exposed, whether or not the users themselves are physically moving, their specific tasks, the duration of their exposure to the stimuli, and individual susceptibility. Furthermore, an individual's susceptibility to motion sickness and related simulator sickness varies widely across different environments (Kolaskinski, 1996). Such susceptibility is not easily predicted from screening tests or experience with motion sickness in terrestrial environments, such as those in aircraft or on board ships (Welch, 2003). In addition, the debilitating effects of space flight on sensorimotor control can exacerbate the difficulties of overcoming sensory conflict.

In spite of the many variables affecting the dilemma of system latency, problems with motion or simulation sickness can be minimized by avoiding displays that produce illusory senses of motion while users are experiencing real time-varying physical accelerations. An example of a user interface that aggravates motion cues is the slewable infrared sensor display in an F-16 IR Maverick missile. It has been reported that changing the angle of the sensor mounted in a deployed missile while maneuvering the aircraft in a motion plane different from that of the missile is very disorienting (Stroud & Klaus, 2006). Because the user controls for remote, mobile space exploration systems can require even more natural interaction with the user's body, and

space-adapted operators are especially subject to the undermining products of sensory conflict, they should be afforded the highest level of display stability.

10.14.4.5 Reduced Sensorimotor Coordination

The second effect of latency on user interfaces is reduced sensorimotor coordination. The amount of latency that will affect coordination depends on the task, but latencies greater than 200 milliseconds (ms) are generally regarded as significant (Fong & Thorpe, 2001). However, much shorter delays can have a noticeable negative effect on performance. Latencies of ~8 to 16 ms can be noticed in body-referenced interfaces such as virtual environments, and productivity declines can be measured for latencies of ~50 ms (Ellis et al., 1999; Ellis et al., 1997). Therefore, designs for systems using body-referenced interfaces must reduce latency to below 50 ms, and less than 8 ms if the interface is intended to present visually stable virtual objects. Predictive filters can be used to remove some of the effects of latency on the stability of computer-generated objects in virtual environment, but current technique can only cancel approximately 16-30 ms of system latency without introducing excessive jitter (Jung, Adelstein, & Ellis, 2000).

If system responsiveness is sluggish due to slow movement speeds or large inertias, the effects of short latencies have diminished impact on overall performance; however, they still may be noticed by a user (Ogata, 1970). When encountering delays of 250 ms to several seconds, or situations in which control is best accomplished by preprogramming multi-segment movements for subsequent action, a “move and wait” strategy may be the practical solution for interactive movement-by-movement control. While this form of interaction is not burdensome for isolated, discrete tasks, such as typing command keys, it can make continuous manual control very challenging and impose high workload (Funk et al., 1993).

As interaction latency grows well past 300 ms, user interaction becomes more episodic and ultimately more dependent on increasingly complete automation. The initial forms of latency compensation for manual control involve the use of predictive filters (Welch & Bishop, 2001) and, eventually, predictive displays (Kim & Bejczy, 1993). Finally, some form of supervisory control should be implemented to make the resulting system semi-autonomous.

10.14.4.6 Reduced productivity

Reduced productivity may be a consequence of the compensation strategies adopted by users to manage system latency. A user forced to adopt a “move and wait” strategy to ensure continuous control may not exhibit obviously disorganized sensorimotor behavior if the strategy is well learned; nevertheless, the user’s productivity is reduced by the interaction latency. Interestingly, the effect of the relationship between user expertise and latency on productivity is nonlinear. For example, regarding short response latencies, the proportional productivity loss is worst for the most expert users. A thorough study conducted over a period of 1 month at IBM showed that the more experienced users of information systems benefit the most from the reduction of system latency (Figure 10.14-6) (Doherty & Thadhani, 1982).

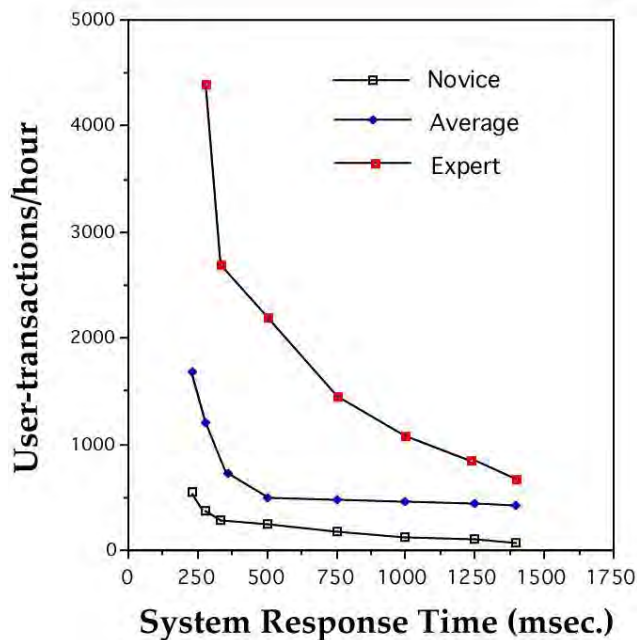


Figure 10.14-6 Transaction frequency vs. response time. From Doherty & Thadhani, 1982.

10.14.4.7 Visual / Manual Aspect of Tasks

The visual / manual aspects of many of the tasks that are desirable to be assigned to mobile systems demand user interfaces that are multimodal and anthropomorphic in design. These characteristics are especially useful in surface-exploration systems and conditions in which the system time lags are very short, much less than 100ms. Such conditions generally correspond to an environment in which the users are physically close to or actually at the worksite. Under these conditions, users driving rovers, controlling manipulators, performing mechanical assembly, or conducting general systems operations can become very productive, with levels approaching that of direct, skilled activity at an Earth-bound worksite. Such multimodal systems have been exhibited as intuitive and natural.

“Telepresent” interfaces to remote systems have improved markedly in the past 25 years. Head-mounted stereoscopic displays that once rendered users “legally blind” have been replaced by systems that are far lighter, have a wide field of view, and approach human visual acuity (e.g., the Rockwell-Collins Optronix SR-100). Robonaut 2, which resides aboard the ISS, can be controlled via tele-operation using such a system. Similarly, the auditory spatialization systems that were once custom-made have now become a software commodity (Miller & Wenzel, 2002), as have haptic displays (SensAble Technologies, 2007). Haptic bandwidth holds significant potential to improve the bandwidth available for user interaction.

Force-reflecting displays have not been tested on orbit; however, they have been used on the ground while connected to manipulators that are on orbit (Hirzinger et al., 1994). The abundant evidence that these displays can improve and extend user dexterity while controlling remote manipulators (e.g., Hannaford et al., 1989) suggests that consideration should be given to their introduction into crewed spacecraft.

10.14.5 User Interfaces for Semi-autonomous Systems

Few space systems are completely autonomous because, at the very least, their operation is supervised by human users who occasionally modify their operation. Human interaction is especially likely with mobile systems; for this reason autonomous mobile systems are best described as being semi-autonomous.

The user interfaces associated with fully autonomous remote systems are not necessarily appropriate for more interactive crewed systems that are controlled by joysticks during direct or remote view of the worksite. However, these interfaces are instructive for reference by the operator when the functions that they separately incorporate are embedded within the more interactive crew systems.

10.14.6 Operational Constraints and Considerations

Systems that perform automated operations must include operational constraints to ensure the safety of the crew and spacecraft. This is especially true for mobile systems that share the same workspace as their human counterpart. The following are some considerations to keep in mind:

- Locus of Control – Individuals in possible direct contact with the machine must have control over machine activity.
- Emergency Shutdown (Motion Stop) – Personnel in possible direct contact with mobile or autonomous systems must have a rapid and reliable emergency shutdown capability.
- Autonomous Shutdown – Autonomous systems must shut down and prominently communicate their termination when their activities are likely to result in mission degradation, equipment damage, or injury to personnel. These systems should fail safe.
- Real-Time Monitoring – Operators must have the capability to monitor the real-time status of autonomous or semi-autonomous systems.
- System Status – Operators need to be aware of mobile system status information including system state, health, current command streams, to provide situation awareness and allow the operator to take appropriate actions when needed.

For the purposes of maximizing user productivity, “real time” means that system response to discrete input is less than 100ms. For purposes of manual control, “real time” means a system update rate of at least 20 Hz with less than 50 ms latency. For purposes of perceptually stable virtual objects presented either on an immersing virtual environment or an augmented reality display, the update rate needs to be at least 60 Hz with latency less than 16 ms.

The system must be designed so that monitoring of that system does not reduce users’ ability to detect off-nominal or dangerous situations.

Crewmembers on long-duration space missions may be expected to operate any system in manual, partially automatic, or supervisory modes. The information requirements for each mode must ensure that crew operation is supported by the planned user interfaces. Nominal operations and intervention actions will have to be practiced *in situ* to maintain operational skills. An

effective method of skill maintenance may be to use compact simulation and training during extended transit flights to the exploration site.

10.14.7 Research Needs

Performance limits need to be determined for general, three-axis misalignments of reference frames used in control of remote systems.

10.15 REFERENCES

- Ahumada, A. J., Scharff, L. V. S., & Watson, A. B. (2007). What Image Does the Visual System Detect Best? Vision Sciences Society Annual Meeting, May, Sarasota, FL.
- Anderson, J. R. & Bower, G. H. (1973). *Human associative memory*. Oxford, England: Winston.
- American National Standards Institute (ANSI). (1990). *Hand-held Robot Control Pendants—Human Engineering Design Criteria*, (ANSI/RIA 15.2-1-1990). New York, NY: American National Standards Institute.
- American National Standards Institute. (1990a). Audible Emergency Evacuation Signal, (ANSI S3.41). New York, NY: American National Standards Institute.
- American National Standards Institute. (1991). Alternate Keyboard Arrangement for Alphanumeric Machines, (ANSI X3.207:1991). New York, NY: American National Standards Institute.
- American Society for Testing and Materials. (1987). *ASTM Standards for Color and Appearance Measurement*. Philadelphia, PA: American Society for Testing and Materials.
- Anandan, M. (2006). *Backlights for LCD/TV: LED vs. CCFL*.
- Anandan, M. (2008). Progress of LED backlights for LCDs. *Journal of the Society for Information Display*, 16(2), 287-310, <http://link.aip.org/link/?JSI/16/287/1>
- Arditi, A., Knoblauch, K., & Grunwald, I. (1990). Reading with fixed and variable character pitch. *J Opt Soc Am A*, 7(10), 2011–2015, http://www.ncbi.nlm.nih.gov/entrez/query.fcgi?cmd=Retrieve&db=PubMed&dopt=Citation&list_uids=2231111.
- Ballou, P. (2007). personal communication, Dr. Ballou was formerly President of Deep Ocean Engineering, San Leandro, California, and is now Senior Vice-President of Ocean Systems, Alameda, California.
- Bangor, A., Kortum, P. T., & Miller, J. A. (2008). An empirical evaluation of the System Usability Scale (SUS). *International Journal of Human-Computer Interaction*, 24(6), 574-594.
- Barten, P. G. J. (1987). The SQRI method: a new method for the evaluation of visible resolution on a display. *Proceedings of the Society for Information Display*, 28, 253–262.
- Becker, M. E. (2006). Display reflectance: Basics, measurement, and rating. *Journal of the Society for Information*, 14, 1003–1017.
- Boschmann, M. C. & Roufs, J. A. J. (1997). Text quality metrics for visual display units: II. An experimental survey. *Displays*, 18, 45–64.
- Bravo, M. J. & Farid, H. (2008). A scale invariant measure of clutter. *Journal of Vision*, 8(1), 1–9, <http://journalofvision.org/8/1/23/>.
- Brooks, F. P. (1999). What’s real about virtual reality? *IEEE Computer graphics and applications*, 19, 16–27.
- BSR/HFES. (2005). *Human factors engineering of computer workstations* (BSR/HFES-100), Santa Monica, CA.: The Human Factors and Ergonomics Society.

- Buchanan, B. G. & Shortliffe, E. H. (Eds.). (1984) *Rule-Based Expert Systems: The MYCIN Experiments of the Stanford Heuristic Programming Project*, (Part 6, Explaining the Reasoning). Reading, MA: Addison-Wesley.
- Bulovic, V. (2005). *Fundamentals of OLEDs and OLED Displays*. Society for Information Display Short Course Notes (pp. Short Course S-4, S-4/1-S-4/82). Campbell, CA: Society for Information Display.
- Byrne, M. D. (2002). Reading vertical text: Rotated vs. marquee. In Proceedings of the Human Factors and Ergonomics 46th Annual Meeting, Baltimore, MD.
- Campbell, J. L., Carney, C., & Kantowitz, B. H. (1998). Human Factors Design Guidelines for Advanced Traveler Information Systems and Commercial Vehicle Operations (FHWA-RD-98-057). Office of Safety and Traffic Operations R&D. Mclean, VA.
- Carlson, C. R. & Cohen, R. W. (1980). A simple psychophysical model for predicting the visibility of displayed information. *Proceedings of the Society for Information Display*, 21(3), 229–245.
- Chung, S. T. (2004). Reading speed benefits from increased vertical word spacing in normal peripheral vision. *Optom Vis Sci*, 81(7), 525–535.
- Chung, S. T. L. (2002). The Effect of Letter Spacing on Reading Speed in Central and Peripheral Vision. *Investigative Ophthalmology Visual Science*, 43(4), 1270–1276, <http://www.iovs.org/cgi/content/abstract/43/4/1270>
- Chung, S. T., Mansfield, J. S., & Legge, G. E. (1998). Psychophysics of reading. XVIII. The effect of print size on reading speed in normal peripheral vision. *Vision Res*, 38(19), 2949–2962, <http://www.ncbi.nlm.nih.gov/htbin-post/Entrez/query?db=m&form=6&dopt=r&uid=0009797990>.
- Cohen, D., Otakeno, S., Previc, F. H., & Ercoline, W. R. (2001). Effect of "inside-out" and "outside-in" attitude displays on off-axis tracking in pilots and non-pilots. *Aviat Space Environ Med*, 72(3), 170–6.
- Commission Internationale de L'Eclairage (CIE). (1977). Radiometric and Photometric Characteristics of Materials and Their Measurement. Central Bureau of the CIE, Vienna.
- Commission Internationale de L'Eclairage (CIE). (1978). Recommendations on Uniform Color Spaces - Color-Difference Equations, Psychometric Color Terms. Central Bureau of the CIE, Vienna.
- Commission Internationale de L'Eclairage (CIE). (1979). Absolute Methods for Reflection Measurements. Central Bureau of the CIE, Vienna.
- Commission Internationale de L'Eclairage (CIE). (1987). International Lighting Vocabulary, 4th ed. : Joint publication IEC/CIE. Central Bureau of the CIE, Vienna.
- Commission Internationale de L'Eclairage (CIE). (1995). Industrial Colour-Difference Evaluation. Central Bureau of the CIE, Vienna.
- Commission Internationale de L'Eclairage (CIE). (1996). The Relationship Between Digital And Colorimetric Data For Computer-Controlled CRT Displays. Central Bureau of the CIE, Vienna.

- Commission Internationale de L'Eclairage (CIE). (2001). Improvement to Industrial Colour-Difference Evaluation. Central Bureau of the CIE, Vienna.
- Degani, A. (2004). *Taming HAL, Designing Interfaces Beyond 2001*, (Chapter 15, Automation, Protections, and Tribulations). New York, NY: Palgrave Macmillan.
- Doherty, W. J. & Thadhani, A. J. (1982). The economic value of rapid response time. IBM report GE20-0752-0 (11/82).
- Ellis, S. R. (1994). What are virtual environments? *IEEE Computer Graphics and Applications*, 14(1), 17–2.
- Ellis, S. R., Bréant, F., Menges, B. M., Jacoby, R. H., & Adelstein, B. D. (1997). Operator interaction with virtual objects: effects of system latency. Proceedings of HCI'97 International. (pp. 973–976). San Francisco, CA.
- Ellis, S. R., Young, M. J., Ehrlich, S. M., & Adelstein, B. D. (1999). Discrimination of changes of latency during voluntary hand movement of virtual objects. *Proceedings of HFES* (pp. 1182–1186).
- Ferketic, J., Goldblatt, L., Hodgson, E., et al. (2006a). Toward Human-Robot Interface Standards I: Use of Standardization and Intelligent Subsystems for Advancing Human-Robotic Competency in Space Exploration. Corrected copy of version in: *Proceedings of the SAE 36th International Conference on Environmental Systems*. 2006-01-2019.
- Ferketic, J., Goldblatt, L., Hodgson, E., Murray, S., & Wichowski, R. (2006b). Toward Human-Robot Interface Standards II: An Examination of Common Elements in Human-Robot Interaction Across the Space Enterprise. AIAA. AIAA 2006 7388.
- Fisher, S. S., McGreevy, M., Humphries, J. & Robinett, W. (1986). Virtual Environment Display System. ACM 1986 Workshop on 3D Interactive Graphics (23-24 October 1986, pp. 77–87). Chapel Hill, NC: ACM.
- Fong, T. & Thorpe, C. (2001). Vehicle teleoperation interfaces. *Autonomous Robots*, 11, 9–18.
- Francis, W. N., Kucera, H., & Mackie, A. W. (1982). *Frequency Analysis of English Usage: Lexicon and Grammar*. Houghton Mifflin, Boston, MA.
- Funk, J. D. Jr., Beck, C. P., & Johns, J. B. (1993). Piloting Vertical Flight Aircraft: A Conference on Flying Qualities and Human Factors NASA. Ames Research Center, (See N94-13294 02-08); pp. 361–374.
- Gaver, W. (1986). Auditory icons: using sound in computer interfaces. *Human-Computer Interaction*, 2, 167–177.
- Ghosh, A. & Hack, M. (2004). *Fundamentals of OLEDs*. Society for Information Display Short Course Notes (pp. Short Course S-1, S-1/1-S-1/90). Campbell, CA: Society for Information Display.
- Hammond, W. E. (2001). Human Factors and Life Support. In: J. S. Przemieniecki, (Ed.), *Design Methodologies for Space Transportation Systems*. Reston, VA: AIAA.
- Hannaford, B. (1989). A design framework for teleoperators with kinesthetic feed-back. *IEEE Transactions on Robotics and Automation*, 5(4), 426–34.

- Hannaford, B., Wood, L., Guggisberg, B., McAfee, D., & Zak, H. (1989). *Performance evaluation of a six-axis generalized force-reflecting teleoperator*. (JPL Publication 89-19, June 15, 1989). Pasadena, CA: Jet Propulsion Laboratory.
- Hansman, R. J. & Cummings, M. (2004). Course 16.422: Human Supervisory Control of Automated Systems. A lecture presented at the Massachusetts Institute of Technology. Online database. http://ocw.mit.edu/NR/rdonlyres/Aeronautics-and-Astronautics/16-422Spring2004/879C77B3-F66B-4FB8-9EC7-7D2B5D139A8E/0/020304_intro.pdf.
- Harris, C. M. (1991). *Handbook of Acoustical Measurements and Noise Control*, 3rd ed., Chp. 16.8. McGraw-Hill, New York.
- Hirzinger G., Brunner, B., Dietrich, J., Heindl, J. (1994) ROTEX - The First Remotely Controlled Robot in Space. ICRA, pp. 2604–2611.
- Human Factors and Ergonomics Society (2007). *Human Factors Engineering of Computer Workstations*, (ANSI/HFES 100-2007). Santa Monica, CA: Human Factors and Ergonomics Society.
- Hunt, R. W. G. (2004). *The Reproduction of Colour* (6 ed.). West Sussex, England: John Wiley & Sons Ltd.
- International Organization for Standardization. (1992). *Visual display requirements*, (ISO 9241-3). Geneva, Switzerland: ISO.
- International Organization for Standardization. (1994). *Anesthesia and respiratory care alarm signals*, (ISO 9703-2). Geneva, Switzerland: ISO.
- International Organization for Standardization. (2001). Ergonomic requirements for work with visual displays based on flat panels – Part2: Ergonomic requirements for flat panel displays, (ISO 9241-3). Geneva, Switzerland: ISO.
- International Organization for Standardization. (2003). *Ergonomics. Danger signals for public and work areas. Auditory danger signals*, (ISO 7731). Geneva, Switzerland: ISO.
- Jung, Jae Y., Adelstein, Bernard D., and Ellis, Stephen R. (2000) Discriminability of Prediction Artifacts in a Time-Delayed Virtual Environment. Proceedings, IEA 2000/HFES2000 44th Ann. Meeting . pp. 1-499
- Kazerooni, H. (1990). Human-Robot Interaction via the Transfer of Power and Information Signals, *IEEE Transactions on Systems and Cybernetics*, 20 (2) 450—463.
- Kelley, E. F. (2006, June). Display measurements for flat-panel displays. Application Tutorial A-6, *Society for Information Display, 2006 International Symposium*, San Francisco, CA.
- Kim, W. S. & Bejczy, A. K. (1993). Demonstration of a high fidelity predictive/preview display technique for telerobotic servicing in space. *IEEE Transaction on Robotics and Automation*, 9(5), 698-702.
- King, C. N. (1994). Electroluminescent Displays. Society for Information Display Seminar Lecture Notes (Vol. 1, pp. Lecture Notes 1, M-9/1-M-9/38). Campbell, CA: Society for Information Display.

- King, C. N. & Schaus, C. F. (1996). Electroluminescent displays, Lasers and Electro-Optics, CLEO '96., Summaries of papers presented at the Conference on , pp. 88-89, URL: <http://ieeexplore.ieee.org/stamp/stamp.jsp?arnumber=864398&isnumber=18726>
- Kirakowski, J., & Corbett, M. (1993). SUMI: the Software Usability Measurement Inventory. *British Journal of Educational Technology*, 24(3), 210-212.
- Klein, S. A. & Carney, T. (1991). "Perfect" displays and "perfect" image compression in space and time. *Proceedings of SPIE*, 1453, 190-205.
- Kolaskinski, E. M. (1996). Prediction simulation sickness in a virtual environments. (Doctoral dissertation, University of Central Florida). Retrieved from <http://www.hitl.washington.edu/scivw/kolasinski/>.
- Krantz, J. H., Silverstein, L. D., & Yeh, Y. Y. (1992). Visibility of transmissive liquid crystal displays under dynamic lighting conditions. *Human Factors*, 34, 615–632.
- Kumar, N., Schmidt, H., Clark, M., et al. (1994). Development of nano- crystalline diamond-based field-emission displays. *Society for Information Display Digest of Technical Papers*, 25, 43-43.
- Legge, G. E., Parish, D. H., Luebker, A., & Wurm, L. H. (1990). Psychophysics of reading. XI. Comparing color contrast and luminance contrast. *J Opt Soc Am A*, 7(10), 2002–2010, <http://www.ncbi.nlm.nih.gov/htbin-post/Entrez/query?db=m&form=6&dopt=r&uid=0002231110>.
- Legge, G. E., Pelli, D. G., Rubin, G. S., & Schleske, M. M. (1985). Psychophysics of reading--I. Normal vision. *Vision Res*, 25(2), 239–252, <http://www.ncbi.nlm.nih.gov/htbin-post/Entrez/query?db=m&form=6&dopt=r&uid=0004013091>.
- Legge, G. E., Rubin, G. S., & Luebker, A. (1987). Psychophysics of reading--V. The role of contrast in normal vision. *Vision Res*, 27(7), 1165-1177, <http://www.ncbi.nlm.nih.gov/htbin-post/Entrez/query?db=m&form=6&dopt=r&uid=0003660667>.
- Levitt, H. (1971). *Transformed Up-Down Methods in Psychoacoustics*. The Journal of the Acoustical Society of America, 49, 467.
- Microsoft Corporation. (1995). *The Windows interface guidelines for software design*, Washington, DC: Microsoft Press.
- Miller, C. A. & Parasuraman, R. (2007). Designing for Flexible Interaction between Humans and Automation: Delegation Interfaces for Supervisory Control. *Human Factors*, 49(1), 57–75.
- Miller, J. D. & Wenzel, E. M. (2002) Recent Developments in SLAB: A Software-Based System for Interactive Spatial Sound Synthesis, Proceedings of the International Conference on Auditory Display, ICAD 2002, Kyoto, Japan, pp. 403-408.
- MIL-HDBK-87213A (2005), Electronically/Optically Generated Airborne Displays, DoD
- MIL-STD-1472F. (1999) Human Engineering, DoD.
- Monsell, S. (2003). Task switching. *Trends in Cognitive Sciences*, 7(3), 134–140.
- National Aeronautics and Space Administration (NASA), (1995). Man-System Integration Standard. NASA-STD-3001.
- Norman, D.A. (2008). *The Design of Everyday Things*. MIT Press, Cambridge, Mass

- Ogata, K. (1970). *Modern control engineering*. New York, NY: John Wiley & Sons, Inc.
- Parasuraman, R., Mouloua, M., & Molloy, R. (1996). Effects of Adaptive Task Allocation on Monitoring of Automated Systems. *Human Factors*, 38(4), 665–679.
- Parasuraman, R., Sheridan, T. B., & Wickens, C. D. (2000). A Model for Types and Levels of Human Interaction with Automation. *IEEE Transactions on Systems, Man, and Cybernetics – Part A: Systems and Humans*, 30(3), 286–297.
- Patterson, R. (1982). *Guidelines for auditory warning systems on civil aircraft* (Report no. 82017). London, UK: Civil Aviation Authority.
- Pelli, D. G., Burns, C. W., Farell, B., & Moore-Page, D. C. (2006). Feature detection and letter identification. *Vision Research*, 46(28), 4646–4674, <http://www.sciencedirect.com/science/article/B6T0W-4K9C562-1/2/3d22863119565906e0ad3760a24b4880>.
- Pelli, D. G., Tillman, K. A., Freeman, J., Su, M., Berger, T. D., & Majaj, N. J. (2007). Crowding and eccentricity determine reading rate. *Journal of Vision*. 7(2), pp. 1-36. <http://journalofvision.org/7/2/20/>.
- Poynton, C. (2003). *Digital Video and HDTV: Algorithms and Interfaces*. San Francisco. CA: Morgan Kaufmann Publishers.
- Psihogios, J. P., Sommerich, C. M., Mirka, G. A., & Moon, S. D. (2001). A field evaluation of monitor placement effects in VDT users. *Applied Ergonomics*, 32(4), 313–325, <http://www.sciencedirect.com/science/article/B6V1W-4379FCC-1/2/75b54b2dd49b15ee0f88d63a30ad2888>.
- Pyke, R. L. (1926). *Report on the legibility of print*, Medical Research Council, Special Research Series. London, UK.
- Robinson, G. S. & Casali, J. G. (2003). Speech communications and signal detection in noise. In E. H. Burger, L. H. Royster, D. P. Driscoll, & M. Lyane (Eds.), *The noise manual*, (5th ed.). Indianapolis, IN: American Industrial Hygiene Association.
- Rosenholtz, R., Li, Y., & Nakano, L. (2007). Measuring visual clutter. *Journal of Vision*, 7(2), 1–22, <http://journalofvision.org/7/2/17/>.
- Sampsel, J. (2006). MEMS-Based Display Technology Drives Next- Generation FPDs for Mobile Applications. *Information Display*, 22(6), 24.
- Sándor, A., Thompson, S., Holden, K., and Boyer, J. (2008). *The Effect of Software Label Alignment and Orientation on Visual Search Time*. Poster at Texas Regional Human Factors and Ergonomic Conference. Austin, TX, April 2008.
- Sándor, A., Holden, K.L. (2009). User interface consistency. Internal report, NASA JSC.
- Sándor, A., Holden, K., Thompson, S., Pace, J., Adelstein, B., Beutter, B., McCann, R., & Anderson, M. (2010). Performance with continuous and discrete cursor control device under vibration frequencies and amplitudes. *SHFE Information Presentation DRP report*.
- Schindler, W. S. (2004). Color plasma displays. Society for Information Display Seminar Lecture Notes 2 (Vol. 2, pp. F-6/1-F-6/34). Campbell, CA: Society for Information Display.

- Schneider, W. & R. M. Shiffrin. (1977). Controlled and automatic human information processing: 1. Detection, search, and attention. *Psychological Review*, 84, pp1-66.
- SensAble Technologies, (2007). Inc.15 Constitution Way, Woburn, MA 01801, manufacturer of PHANToM line of haptic displays. www.sensable.com.
- Sheridan, T. B. (2002) *Humans and Automation: Systems Design and Research Issues*. New York, NY: John Wiley & Sons, Inc.
- Silverstein, L. D. (2003). *Display visibility in dynamic lighting environments: Impact on the design of portable and vehicular displays*. Paper presented at the Proceedings of the International Display Manufacturing Conference.
- Silverstein, L. D. & Merrifield, R. M. (1985). *The development and evaluation of color systems for airborne applications*. Springfield, VA: National Technical Information Service.
- Smith, K. U. & Smith W. M. (1962). *Perception and Motion: An Analysis of Space-Structured Behavior*. Philadelphia, PA: W.B. Saunders.
- Society of Automotive Engineers (SAE), (1978). Performance, test, and application criteria for electronically operated backup alarm devices (ANSI/SAE J994b-1978). Warrendale, PA.
- Space Flight Operations Contract. Caution and Warning C&W 21002, USA 006019. October 1, 2004
- Space Flight Operations Contract, (2004). Shuttle Crew Operations Manual- SCOM-Section 2.2 Caution and Warning"- available at <http://www.shuttlepresskit.com>
- SSP 50005 (2006). International Space Station Flight Crew Integration Standard.
- Stanton, N. A. & Edworthy, J. (1999). *Human factors in auditory warning systems*. Aldershot, UK: Ashgate.
- Steinfeld, A., Fong, T., Kaber, D., Lewis, M., Scholtz, J., Schultz, A., & Goodrich, M. (2006). *Common Metrics for Human-Robot Interaction*. Association for Computing Machinery. ACM 1-59593-294-1/06/0003.
- Stephenson, A. (1999). Mars Climate Orbiter: Mishap Investigation Board Report. *NASA*, November, 10.
- Stroud, K. J. & Klaus, D. M. (2006). Spacecraft Design Considerations for Piloted Reentry and Landing. *Journal of the British Planetary Society*, 59 (12), 426-442.
- Stupp, E. H. & Brennesholtz, M. S. (1999). *Projection Displays*. New York, NY: John Wiley & Sons
- Tatsuhiko, M., Yoshihide, S., Takehiro, N., Shuichi, H., Hiroaki, E., Yoshiyuki, A., et al. (2006). 19.2: xvYCC: A New Standard for Video Systems using Extended-Gamut YCC Color Space. *SID Symposium Digest of Technical Papers*, 37(1), 1130-1133.
- TCO '03. (2003) *Displays*. The Swedish Confederation of Professional Employees. Stockholm, Sweden.
- TCO '05. (2005) *Desktops*. The Swedish Confederation of Professional Employees. Stockholm, Sweden.

- TCO '06. (2006) *Media Displays*. The Swedish Confederation of Professional Employees. Stockholm, Sweden.
- Thompson, S., Meyer, A., Sándor, A., and Holden, K. (2009). *A functional evaluation of cursor control devices for space vehicles under discrete modes of operation*. JSC, NASA document.
- Tinker, M.A. (1963). *Legibility of print*. Iowa State University Press, Ames, IA.
- Tognazzini, B. (2003) ASKTOG. Online database.
- Tsang, P. S., & Vidulich, M. A. (2002). *Principles and practice of aviation psychology*: CRC.
- U.S. Navy (2000) Into the deep, All Hands, June, 2000
<http://www.mediacen.navy.mil/pubs/allhands/jun00/pg14.htm>.
- Video Electronics Standards Association (VESA). (2001). *Flat Panel Display Measurements Standard (FPDM)*, (Version 2.0). Milpitas, CA: Video Electronics Standards Association.
- Watson, A. B. (2006). The Spatial Standard Observer: A human vision model for display inspection, *SID Symposium Digest of Technical Papers*, 37, 1312-1315,
<http://vision.arc.nasa.gov/publications/Watson-2006-sid-31-1.pdf>.
- Watson, A. B. & Ahumada, A. J., Jr (2005a). A standard model for foveal detection of spatial contrast. *Journal of Vision*, 5(9), 717–740, <http://journalofvision.org/5/9/6/>.
- Watson, A. B. & Ahumada, A. J., Jr. (2005b). Predicting acuity from the Spatial Standard Observer. *Invest Ophthalmol Vis Sci*, 46, ARVO E-Abstract 3614.
- Watson, A. B., & Ahumada, A. J., Jr. (2007). Predicting visual acuity from wavefront aberrations. *Journal of Vision*, in press.
- Watson, A. B., Barlow, H. B., & Robson, J. G. (1983). What does the eye see best? *Nature*, 302(5907), 419–422.
- Welch, Greg & Bishop, Gary (2001) An introduction to the Kalman filter, Course Notes, Course 8, SIGGRAPH 200, <http://www.cs.unc.edu/~tracker/ref/s2001/kalman/index.html>.
- Welch, R. B. (2003). Adapting to telesystems. In *Virtual and adaptive environments: applications, implications, and human performance issues*. New York, NY: Erlbaum.
- Wickens, C. D., & Hollands, J. G. (2000). *Engineering psychology and human performance*. New Jersey: Prentice Hall.
- Woods, D. D. (1995). The alarm problem and directed attention in dynamic fault management. *Ergonomics*, 38 (11), 2371–2393.
- Wyszecki, G. & Stiles, W. S. (1982). *Color Science* (2 ed.). New York, NY: John Wiley and Sons.
- Zwicker, E. & Fastl, H. (1990). *Psychoacoustics. Facts and models*. Berlin, Germany: Springer Verlag.

TABLE of CONTENTS

11	EXTRAVEHICULAR ACTIVITY.....	1105
11.1	INTRODUCTION.....	1105
11.2	LIFE SUPPORT FUNCTIONS.....	1105
11.2.1	Introduction	1105
11.2.2	Suit Atmosphere.....	1106
11.2.2.1	Total Pressure.....	1106
11.2.2.2	Oxygen	1108
11.2.2.3	Carbon Dioxide.....	1108
11.2.2.4	Temperature	1109
11.2.2.5	Relative Humidity	1109
11.2.2.6	Atmosphere and Physiological Parameter Display and Alerting	1110
11.2.2.7	Atmosphere Parameter Control.....	1110
11.2.3	Nutrition	1110
11.2.4	Hydration.....	1111
11.2.5	Waste Management.....	1112
11.2.5.1	Urine.....	1112
11.2.5.2	Feces.....	1113
11.2.5.3	Vomitus.....	1113
11.2.6	Injury Treatment.....	1113
11.2.7	Research Needs	1114
11.3	EVA PERFORMANCE	1115
11.3.1	Introduction	1115
11.3.2	Suited Visual Performance.....	1115
11.3.3	Suited Anthropometry	1117
11.3.4	Suited Reach and Range of Motion.....	1119
11.3.5	Suited Strength Performance.....	1122
11.3.6	Suited Maneuverability	1123
11.3.7	EVA Crew Restraints.....	1124
11.3.8	EVA Mobility Aids.....	1126
11.3.9	EVA Translation Paths.....	1127
11.3.10	Work Efficiency	1128
11.3.11	EVA Acoustics and Noise.....	1128
11.3.12	EVA Lighting.....	1130
11.3.12.1	Orbital EVA Lighting.....	1130
11.3.12.2	Effects of EVA Helmets on Lighting.....	1130
11.3.12.3	Planetary Surface EVA Lighting.....	1130
11.3.13	Research Needs	1131
11.4	EVA SAFETY.....	1132
11.4.1	Introduction	1132
11.4.2	Radiation	1132
11.4.3	Chemical Contamination	1132
11.4.4	Decompression	1132
11.4.4.1	Sharp Edges.....	1133
11.4.4.2	Micrometeoroid and Orbital Debris Impact	1135

11.4.5	Entrapment	1135
11.4.6	Electrical Hazards	1135
11.4.7	Research Needs	1135
11.5	REFERENCES	1136

TABLE of FIGURES

Figure 11.2-1 Cabin suit pressure combinations related by R-values.....	1107
Figure 11.2-2 Options for vehicle and suit pressures within an acceptable range of decompression sickness risk, R=1.40 at suit pressure of 6.0 psia.....	1107
Figure 11.2-3 Options for vehicle and suit pressures within an acceptable range of decompression sickness risk, R=1.58 at suit pressure of 6.0 psia.....	1108
Figure 11.2-4 Time allowed in pressure suit.....	1109
Figure 11.2-5 Shuttle EMU in-suit drink bag.....	1112
Figure 11.3-1 EMU helmet field of view.....	1117
Figure 11.3-2 Extravehicular Mobility Unit.....	1118
Figure 11.3-3 Maximum side reach envelope.....	1120
Figure 11.3-4 Maximum forward reach envelope.....	1121
Figure 11.3-5 Joint EVA and Orion evaluation in the Neutral Buoyancy laboratory at JSC, Houston, TX.....	1124
Figure 11.3-6 Shuttle portable foot restraint.....	1125
Figure 11.3-7 Shuttle EVA handhold dimensions.....	1126
Figure 11.3-8 Standard Shuttle handrail locations.....	1127
Figure 11.3-9 EVA translation path sizing.....	1128
Figure 11.4-1 Exposed corner and edge requirements.....	1134

TABLE of TABLES

Table 11.1-1 Crewmember Metabolic Rates for Suited Operations, kJ/h (Btu/h)	1105
Table 11.3-1 EMU Helmet Visual Performance	1116
Table 11.3-2. Maneuverability Assessment Scale Questionnaire	1123
Table 11.4-1 Edge, Corner, and Protrusion Criteria – Edge and In-Plane Corner Radii*	1133
Table 11.4-2 Snag and Sharp Edge Hazards	1134

11 EXTRAVEHICULAR ACTIVITY

11.1 INTRODUCTION

Extravehicular activity (EVA) is any activity performed by a pressure-suited crewmember in unpressurized environments internal or external to space flight habitable modules, in space environments, or in extraterrestrial environments with atmospheres unable to support human life. In this chapter, life-support functions, human performance, and safety of pressure-suited crewmembers are discussed.

11.2 LIFE SUPPORT FUNCTIONS

11.2.1 Introduction

Pressure suits are necessary to provide life support to crewmembers in the hazardous environments encountered during space flight. Life-support functions are the same for spacecraft and pressure suits and include

- adequate pressure across the entire body
- proper partial pressure of oxygen to the lungs for respiration
- carbon dioxide removal
- temperature and humidity control
- provisions for food and water
- collection of urine and feces

Suited operations encompass a diverse set of activities that result in varied metabolic rates. The suit must accommodate the expected range of activities by providing adequate consumables such as oxygen, water, and food, and by removing generated heat, humidity, carbon dioxide, and bodily waste. The suit and supporting systems must accommodate contingency operations, including additional consumables and loads on the suit environmental control system. Table 11.1-1 contains ranges of metabolic rates expected during suited operations, although this table will evolve as the operations concept matures. Therefore, these data are used only as historical reference and in progress estimates, not as design goals.

Table 11.1-1 Crewmember Metabolic Rates for Suited Operations, kJ/h (Btu/h)

Data Source	Minimum	Average	Maximum ¹
μ Gravity EVA (ISS and STS)	575 (545) ²	950 (900) ³	2320 (2200)
Apollo Lunar Surface EVA	517 (490) ²	1030 (980)	2607 (2471)
Advanced Walkback Test ⁴	1767 (1675) ¹	2505 (2374)	3167 (3002)

¹ Transient condition less than 15 min in duration, individual instance

² Minimum for low-activity EVA durations

³ Includes Orlan ISS EVAs, which trend to slightly higher metabolic rates

⁴ Simulated 10-km (6.2-mile) lunar surface walk requiring 1 to 2 hours to complete, in case of rover failure, n = 6

11.2.2 Suit Atmosphere

11.2.2.1 Total Pressure

As discussed in section 6.2 Internal Atmosphere the total pressure applied to the body, whether in a suit or vehicle, must be sufficient to prevent the vaporization of body fluids. The limits of total pressure for crew exposure are described in Table 6.2-1.

However, some important additional factors should be considered when the total pressure of a suit is established, including mobility and decompression sickness (DCS) risk.

- A low suit pressure has the benefit of reducing spacesuit operating force, pressure load, and structural bulk. In current state-of-the-art soft spacesuit design, lower suit total pressure results in increased user mobility. The Extravehicular Mobility Unit (EMU) that is used for Shuttle and ISS EVAs operates at 4.3 psi total pressure.
- An EVA suit pressure greater than or equal to the partial pressure of the diluent gas (i.e., nitrogen) of a space-flight module to which an EVA crewmember has been acclimated has the benefit of reducing or eliminating the prebreathe time required to denitrogenate the body to preclude DCS. Generally, this also provides the benefit of ample margin between suit operating pressure and minimum suit emergency pressure.

Optimal cabin and suit pressure combinations will minimize the crew time required for EVA prebreathe and preclude DCS. An index of decompression stress, called the R-value, is the ratio of tissue partial pressure nitrogen (ppN_2) to the final total pressure. The Space Shuttle Program defined an acceptable R-value to be 1.65. R-value does not account for many factors that determine prebreathe efficacy, including but not limited to increased metabolic rate during prebreathe, the duration of the EVA exposure, the effects of gravitational level on blood perfusion, and musculoskeletal-induced nucleation of dissolved gas. Additionally, data and model predictions show that Iso-risk R-values are a function of the suit pressure, with higher suit pressures producing higher R-values at a given risk level. This relationship is shown in Figure 11.2-1, which depicts the two ranges of Iso-risk that generally bracket a range of acceptable DCS risk.

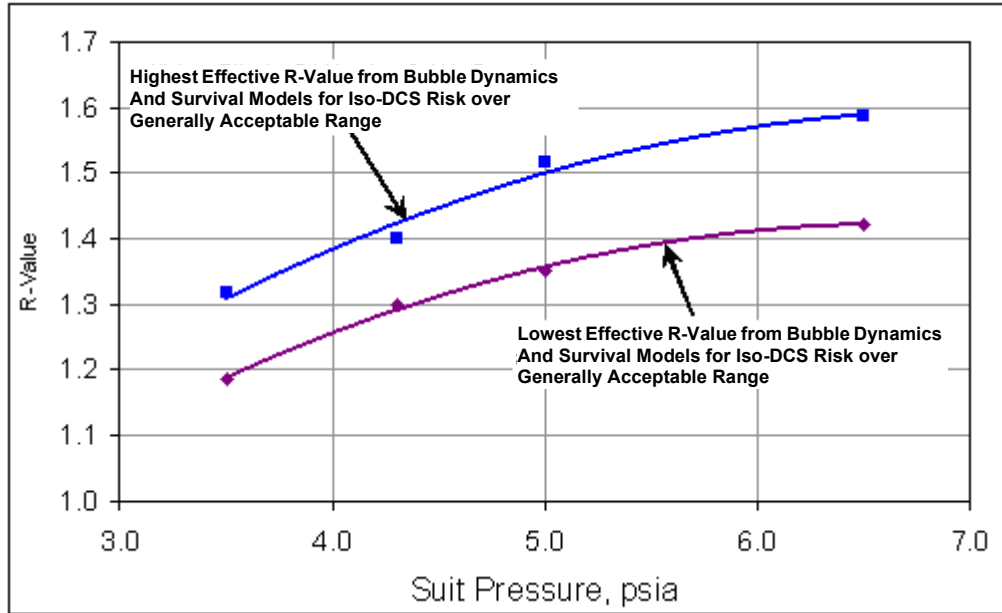


Figure 11.2-1 Cabin suit pressure combinations related by R-values.

Figures 11.2-2 and 11.2-3 describe options for habitat and suit pressures for given DCS risks. The “design space” is bounded by sea level and 1829-m (6000-ft) equivalent alveolar oxygen levels, the Shuttle materials certification limit, and the chosen R-value for a given suit pressure. See section 6.2.2.1.1 for more information on DCS.

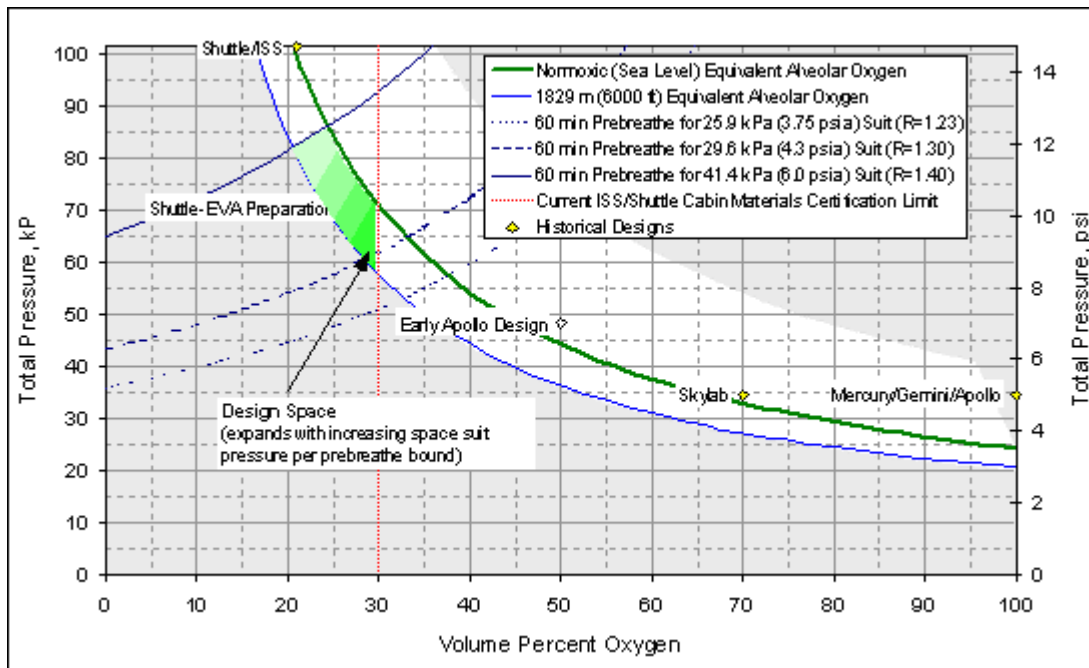


Figure 11.2-2 Options for vehicle and suit pressures within an acceptable range of decompression sickness risk, R=1.40 at suit pressure of 6.0 psia.

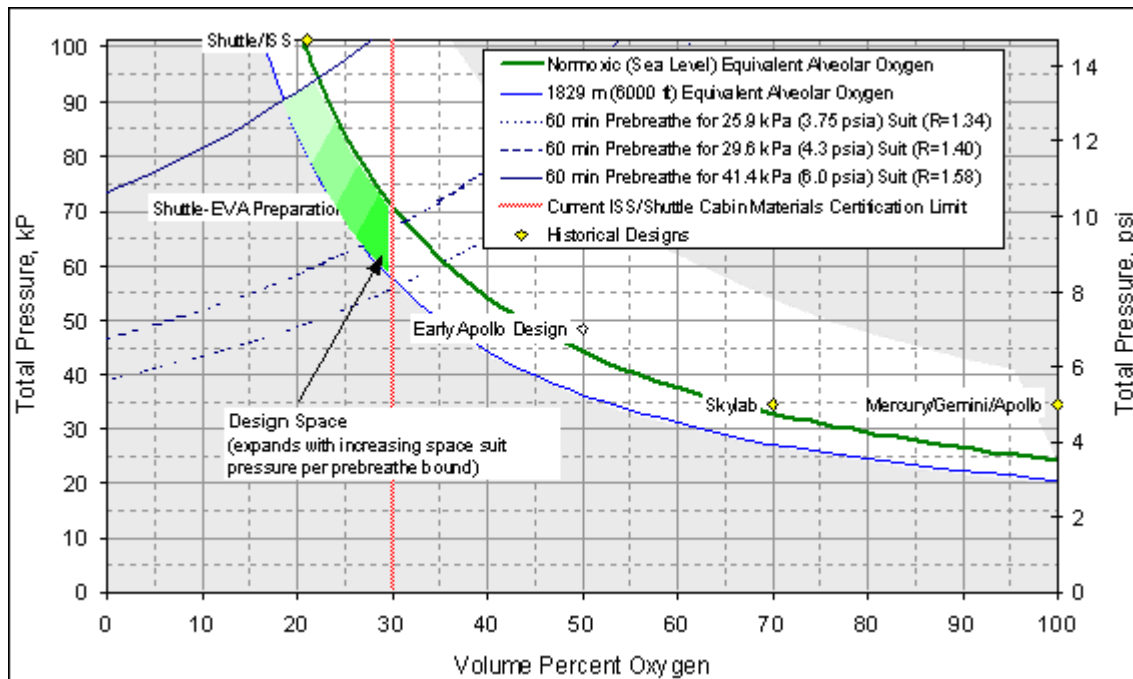


Figure 11.2-3 Options for vehicle and suit pressures within an acceptable range of decompression sickness risk, $R=1.58$ at suit pressure of 6.0 psia.

Maintaining a constant pressure level after a set point has been reached is important to protect the crew from discomfort in body cavities and sinuses, especially in the ear. Because of the nominal pressure changes and the relatively small total pressure volume in a suit, it is important that the pressure-suited crewmember be exposed to a pressure set point that is constant. Excess fluctuations in suit pressure will cause pressurized suited crewmembers to constantly re-equilibrate pressure in body cavities and sinuses, which will increase the likelihood of pressure-induced discomfort in these areas. The suit must maintain each individual suit pressure to within 0.1 psi after that suit has achieved an equilibrium pressure for a set point.

Another important consideration for pressure inside the suit is minimizing the rate of pressure change to prevent discomfort and barotrauma. See section 6.2.2.1.2 for more information on barotrauma.

11.2.2.2 Oxygen

As discussed in section 6.2 Internal Atmosphere, the partial pressure of oxygen (ppO_2) delivered to the lungs, whether in a suit or vehicle, must be sufficient to prevent hypoxia, yet must be low enough to prevent oxygen toxicity (see Table 6.2-4). Suits are typically designed to operate with 100% oxygen, both to reduce DCS risk and because low total suit pressure is near the limit for ppO_2 .

11.2.2.3 Carbon Dioxide

While the limits for carbon dioxide are the same for a pressure suit as they are for a vehicle, the ability to monitor and remove it in a suit is different. Since carbon dioxide is produced upon exhalation, it tends to be localized in the helmet. Without adequate airflow to recycle the air,

carbon dioxide tends to build up around the face and be inhaled again. To prevent this from occurring, the flow of air into the helmet must be sufficient to remove carbon dioxide and replenish oxygen throughout the range of expected activity and respiration rates. In addition, carbon dioxide monitoring in the helmet must be provided so that the wearer is able to quickly identify a problem with the suit's environmental control system.

11.2.2.4 Temperature

See section 6.2.3.1, Temperature, for guidance on maintaining proper thermal loads on the crewmember for nominal operations. When a crewmember is in a suit with no active cooling, heat storage may increase rapidly. Johnson Space Center (JSC) thermoregulatory models, simulating hot cabin entries by astronauts wearing launch and entry suits with the thickness, conductance, wickability, and emissivity properties of the Advanced Crew Escape Suit, predicted loss of body cooling mechanisms. Data from military aircrew protective ensembles also found that body temperature increases more rapidly over time in pressure suits than in a shirt-sleeve environment. Figure 11.2-4 (Wissler Model, Wissler, 1986) provides the time allowance in a suit (without active cooling), as limited by environmental conditions and activity level, before the onset of cognitive impairment.

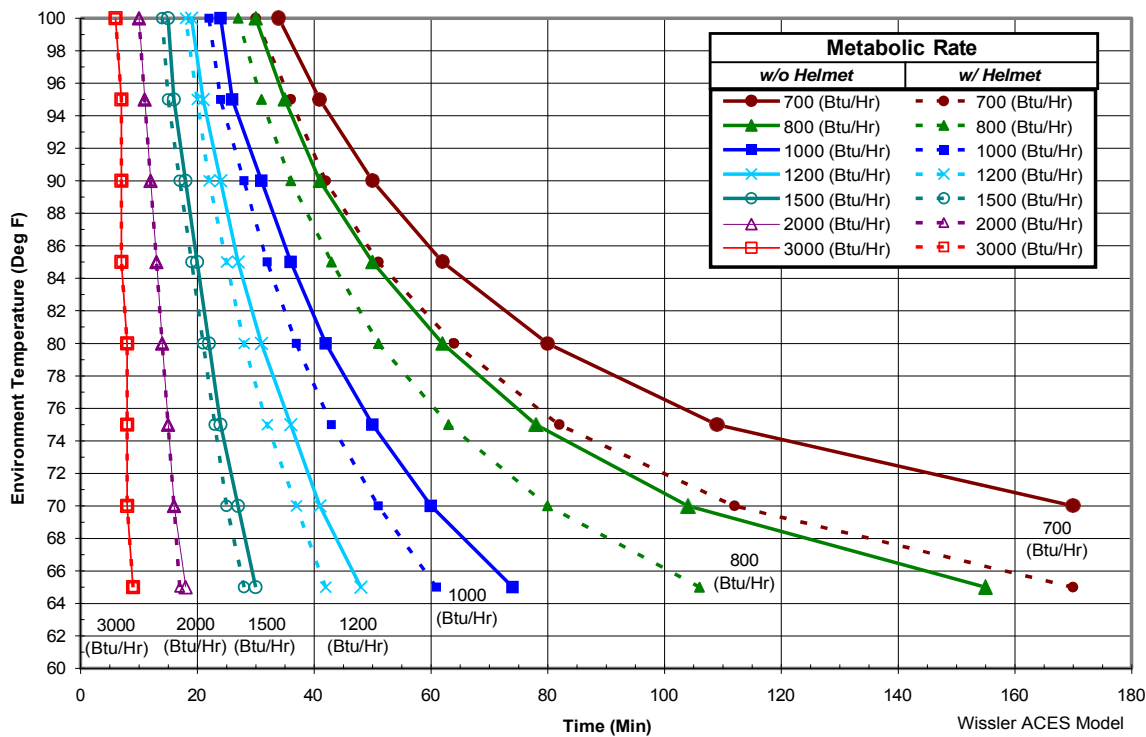


Figure 11.2-4 Time allowed in pressure suit.

11.2.2.5 Relative Humidity

For suited operations in excess of 12 hours, relative humidity must be maintained above 20% to ensure the environment is not too dry for the nominal functioning of mucous membranes, maintained below 75% for crew comfort, and to allow effective evaporation and to limit the

formation of condensation. Excess moisture in the glove can contribute to trauma at the fingertips.

11.2.2.6 Atmosphere and Physiological Parameter Display and Alerting

Feedback of relevant suit atmospheric and physiologic information to the crew will allow better consumable management, improve optimization of EVA task performance, and reduce risk of physiologic stress and injury. Atmospheric parameters that must be displayed to the EVA crew are total pressure, ppO₂, and ppCO₂. Suit consumables, such as power, oxygen, and water, must also be measured and relayed to the crewmember. In addition, having insight into trends in physiologic parameters and life-sustaining consumables will allow the IVA or EVA crew to act prospectively in preventing unsafe operating conditions, or responding to off-nominal scenarios.

Measurement of physiologic parameters, such as heart rate, ECG, and body temperature, during contingency and mission-preserving EVA, as well as during unrecoverable vehicle pressure loss, is necessary to ensure the health and safety of the crewmember(s). The intent is to obtain biomedical data during suited operations, with minimal crew time or effort required to don and doff the measurement hardware while maintaining crew comfort.

Alerting the crew as soon as relevant suit atmospheric and physiologic parameters move into the off-nominal range will allow the crew to appropriately react to off-nominal scenarios, before unsafe operations develop.

EVA and IVA crewmembers may need to see biomedical telemetry data during EVA, as well as during unrecoverable vehicle pressure loss, to ensure the health and safety of the crewmember(s) and to provide appropriate information to the ground support team. Knowledge of the biomedical data and relevant suit atmospheric conditions will maximize the ability of the crew to manage resources for the event, and minimize risk for the crewmember(s). These data need to be monitored during nominal planetary surface operations to ensure the health and safety of the crew. However, automated suit algorithms, rather than ground medical support, may be the primary method of monitoring, especially on long-distance missions, such as Mars missions, where near-real-time communication with Earth is not possible.

11.2.2.7 Atmosphere Parameter Control

The ability of the crew to adjust their suit pressure is an important design consideration. For efficient workload, the crew needs to be able to select a minimum operating pressure. In the case of an unrecoverable vehicle pressure failure where the crew is not able to prebreathe before operating in a pressurized suit, the crew will need to be able to select a higher pressure to mitigate the risk of DCS, followed by the ability to select a midrange suit operating pressure to allow more mobility to operate the vehicle.

Some tasks may require periods of high and low physical exertion, and variable exposure to the Sun, which will affect body heat and moisture content. The ability to adjust temperature and humidity is important to maintain comfort in the suit.

11.2.3 Nutrition

As shown in Table 11.2-1, EVA energy expenditure will usually be high enough to demand additional caloric energy. The type and amount of food to be provided on an EVA will depend

on the gravity environment, EVA duration, expected tasks, and estimated energy expenditure. See section 7.2 Food and Nutrition for more information on crew nutritional needs and food.

Shuttle and ISS EVAs typically last 6 to 8 hours, plus 2 to 3 hours inside the suit during EVA preparation, airlock depressurization, and re-pressurization. The EVA duration is typically limited by the suit consumables, such as oxygen, as well as the duration of EVA preparation and post-EVA cleanup. The EMU uses Velcro to hold a food bar at the top of the hard upper torso (HUT) for crewmembers to consume during EVA, but because of the potential for crumbs to come loose in the helmet and difficulty eating it, many astronauts elect instead to simply eat the food bar or additional food immediately before the EVA.

The duration of surface (i.e., lunar, Mars) EVAs may be similar to those at 0g in terms of consumables, but activities will likely require much greater energy expenditure than a 0g EVA. Therefore, additional calories will need to be provided to EVA crewmembers to maintain high performance levels during surface EVAs. The presence of gravity will minimize problems related to loose food particles. The Apollo Summit strongly recommended the availability of a high-energy substance, either liquid or solid, for consumption during a surface EVA.

During suited operations longer than 12 hours, the crew will need to consume nutrition in excess of what is likely available inside the suit. The suit should allow for the delivery of nutrition to the pressurized suited crew to occur during extended contingency use of pressure suits. The nutrition in contingency cases such as unplanned cabin depressurization could be delivered via a hydration drink port, similar to that used on Apollo missions, and may consist of a low-residue substance.

11.2.4 Hydration

Potable water is needed during suited operations to prevent dehydration due to insensible water loss and to improve crew comfort. The amount of water necessary depends on the EVA duration and tasks, and on the expected energy expenditure and resulting dehydration.

During long-duration suited operations, such as an unplanned pressure reduction scenario, the crew will need to consume additional water in excess of what is likely available inside the suit, to prevent crew performance degradation associated with dehydration. For both nominal and contingency scenarios, one solution is to have the potable water system be rechargeable from an external source, as long as the internal suit reservoir has sufficient capacity to allow ready access to water without affecting work efficiency.

The crewmembers at the 2006 Apollo Summit strongly recommended that 237 ml (8 oz) of water per hour be available for consumption during a lunar EVA, with water available for contingency scenarios, such as a 10-km (6.2-mi) walk-back in case of rover failure (Scheuring et al., 2007).

The Shuttle EMU can hold a drink bag of 621 or 946 ml (21 or 32 oz), which is secured to the inside front of the HUT by Velcro. Astronauts use a straw-like tube at the top of the bag for drinking (Figure 11.2-5, GIAG-3, 1986).

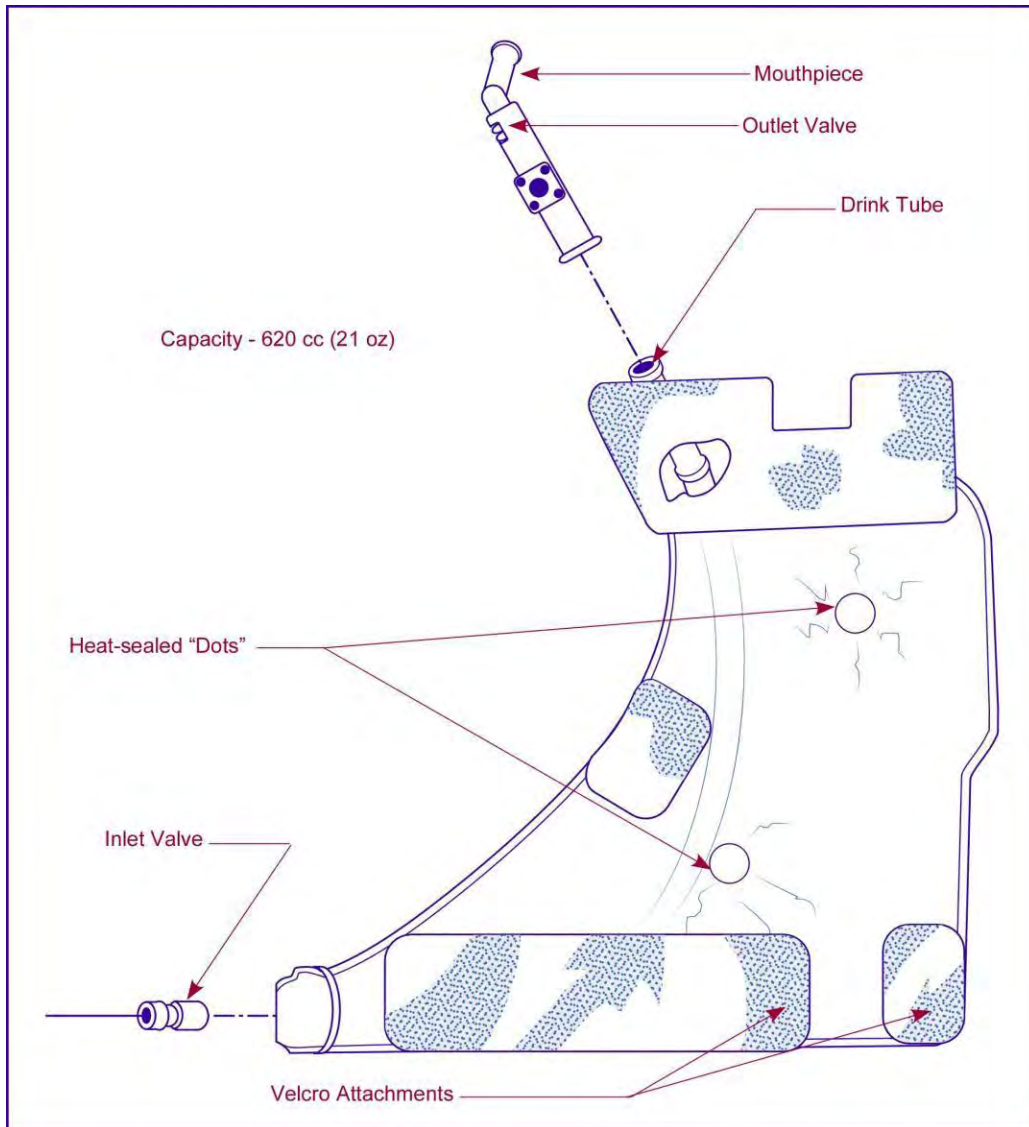


Figure 11.2-5 Shuttle EMU in-suit drink bag.

11.2.5 Waste Management

Given the length of nominal suited operations, there is a high likelihood that crewmembers will need to urinate, as well as the possible need to defecate, while in the suit. In addition, the suit should provide a means to manage vomitus from an ill crewmember, which can become especially dangerous in 0g.

11.2.5.1 Urine

The suit must be capable of collecting a quantity of urine throughout suited operations, as determined by:

$$0.5 + 2t/24 \text{ liters, where } t \text{ is suited duration in hours}$$

This quantity allows crewmembers to eliminate liquid waste at their discretion without affecting work efficiency during suited operations. The expected daily urine output is 2 L (2.1 qt) per day; 0.5 L (0.53 qt) is the minimum for a single void (Wein et al., 2007). In the equation, the $2t/24$ L protects for a second void while the crewmember is suited.

The EMU includes a diaper-like maximum absorbency garment for urine and feces collection during EVAs.

In the event of an unrecoverable vehicle pressure failure, crewmembers may have to remain suited for several days without having the capability to access the fecal and urine collection system. The suit must be able to collect and contain 1 L (1.1 qt) per crewmember per day of urine during such an event; this amount reflects the altered water and nutrition supplied during contingency suited operations.

11.2.5.2 Feces

Depending on diet and health, a crewmember may need to defecate while wearing an EVA suit. However, astronauts tend to wait to defecate until they can use the vehicle's waste management system after the EVA.

In the event of an unrecoverable vehicle pressure failure, crewmembers may have to remain suited for several days without having the capability to access the fecal and urine collection system. The system must collect and contain 75 g (2.6 oz) (by mass) and 75 ml (2.5 oz) (by volume) of fecal matter per crewmember per day during an unrecoverable vehicle pressure failure. For the suit to contain feces, the fecal output during suited operations should be reduced with a low residue diet, to not exceed the maximum containment of the suit's waste collection garment.

11.2.5.3 Vomitus

Space motion sickness, which often includes vomiting, usually affects crewmembers in the first 72 hours of flight. Because of this, EVAs are not planned for the first 72 hours of flight. However, if an unplanned EVA takes place earlier than 72 hours or a crewmember continues to have space motion sickness symptoms after that time, vomiting in the suit may occur. On the lunar surface, a high-magnitude solar particle event could result in radiation exposures that produce nausea and vomiting. If vomitus enters the internal suit environment, it must be kept away from the suited crewmember's nose to prevent inhalation, which could cause asphyxiation. In 0g, directing airflow to move vomitus out of the helmet, or providing a pouch with a valve to contain the vomitus may be considered. In a gravity environment, the ability for vomitus to drain downward from the helmet should be provided. The suit should provide for isolation of the crewmember from vomiting events of 0.5 L (1.1 pt) each.

11.2.6 Injury Treatment

In the event that a crewmember becomes ill or injured while in the suit, the ability must exist for a suited crewmember to transport an injured or incapacitated suited crewmember. In the 0g EVA environment, injuries are most likely to result from electrocution or the impact of a micrometeoroid or orbital debris (MMOD). Preventing these hazards is discussed in section 11.4 EVA Safety. Treatment of the resulting injuries depends on the environment. The crewmember should be transported to a pressurized vehicle as soon as possible for assessment of injuries. In 0g, accomplishment of these tasks will depend on several factors including adequate size,

location, and placement of restraints and mobility aids, as well as a safe location on the suit to grab the crewmember for pulling. The size and shape of translation paths and hatches will need to accommodate assisted mobility and ingress.

In a gravity environment, the weight of the suited crewmember requires different considerations for transport. In some situations, additional tools and equipment may be needed, especially if only one other crewmember is present. For example, if the injured crewmember is on steep terrain and needs to be pulled upward, a rope attached to a rover or other sufficient anchor, or pulley system may be needed. In addition, a load-bearing rope attachment point on the suit is needed. Additional equipment, such as a manual or powered winch, may be needed to effectively and safely move the incapacitated crewmember. A litter, or similar protection, also is needed to protect the crewmember from further injury and prevent damage to the suit while the crewmember is being pulled (Chappell & Klaus, 2004; Chappell et al., 2007).

After an injured or ill-suited crewmember is brought into the pressurized cabin, the design of the suit must allow another crewmember to quickly gain access to the injured part of the body and areas used for diagnosis or treatment, including the head, neck, and chest, and to administer care in the suit, such as providing medication, wound care, and CPR. After initial stabilization, the suit must allow assisted suit egress, and not rely on the injured crewmember to help.

11.2.7 Research Needs

Testing/research in simulated reduced gravity of incapacitated suited crewmember transport with projected surface EVA team sizes is needed.

11.3 EVA PERFORMANCE

11.3.1 Introduction

Pressure suits are typically massive and bulky, and limit performance more than a shirtsleeve environment does.

Limitations of suited operations include

- Sensory degradation (limited field of view, tactile feedback, acoustics)
- Limited crewmember mobility and dexterity, force application, and endurance
- Limitations on working volume and access
- Long preparation and clean-up times
- Consumables

Improving suited visual performance, reach, range of motion, strength, and mobility are key to improving overall EVA performance. In addition, it is important to ensure that the acoustic and lighting environment are ideal for suited conditions, and consider the design of the suit and expected operations.

11.3.2 Suited Visual Performance

A crewmember in a spacesuit may have a restricted field of view (FOV) because of limitations imposed by the suit, helmet, and visor assembly. The EVA suit must provide adequate FOV to perform suited IVA and EVA operations. Concurrently, consideration should be given to the placement of critical EVA equipment within the visual limits of the helmet. Equipment required to be seen by a pressure-suited crewmember must be located within the FOV of the crewmember.

Equipment mounted to the helmet (e.g., head mounted displays) for suited operations must not obstruct the FOV. The helmet visor must provide adequate visual resolution to perform all expected tasks, including vehicle repair and maintenance, and scientific objectives such as identification of geologic samples. If a visor is used, it should promote an adequate FOV to perform EVA tasks and prevent tunnel vision.

Depending on the size and shape of the visor, it may have some refractive distortion, which affects the perceived shape and location of objects in the peripheral vision. Refractive distortion must not interfere with task performance or contribute to spatial disorientation.

In addition, the capability to reduce glare and contrast ratios must exist. The Sun or other bright light sources may be in the FOV, and reflective surfaces such as the spacecraft exterior or lunar surface will be much brighter than the surrounding blackness of space (section 8.7.3, Glare).

Due to the close proximity of the mouth and nose to the visor, and the relative humidity in the suit atmosphere, fogging of the visor is possible. This can be dangerous, preventing the crewmember from seeing handholds and hazards. During the Gemini 9 flight, Gene Cernan's visor fogged when the EVA life support system could not keep up with his increased workload, leading to the cancellation of some EVA objectives and difficulty reentering the spacecraft.

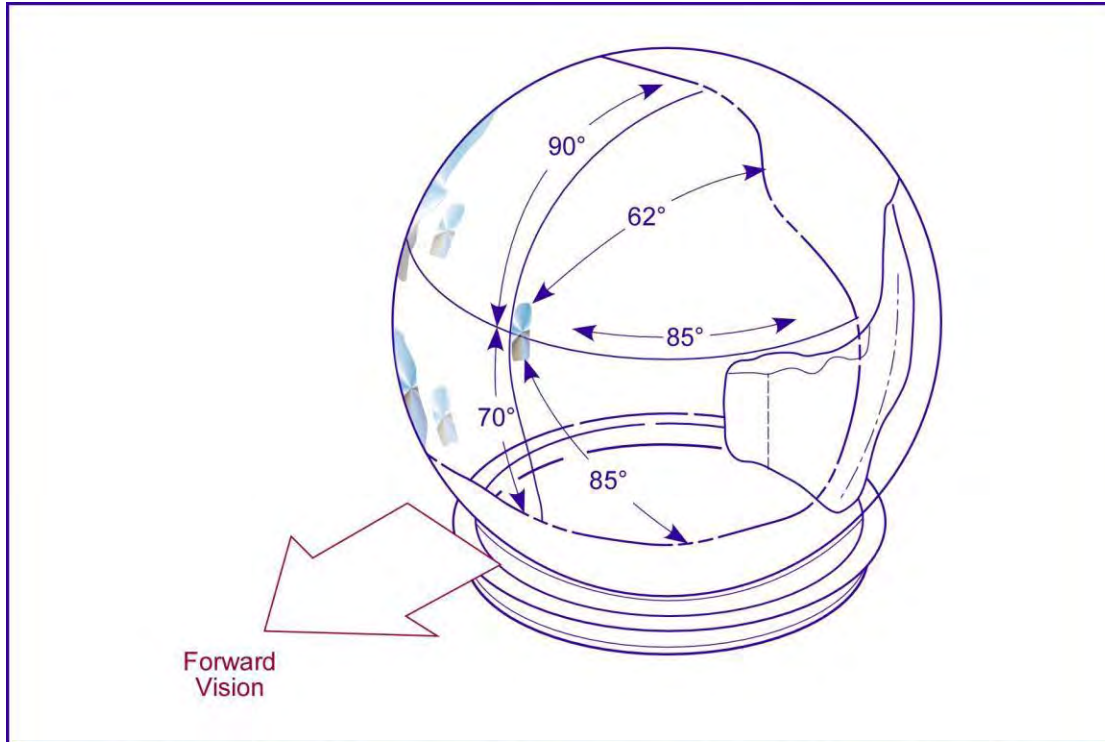
The EMU helmet-visor system provides a minimum unrestricted FOV (body-fixed) of 120-degrees left and 120-degrees right in the horizontal plane. In the vertical plane, 105-degrees

down and 90-degrees up visibility is provided. The EMU visor allows the crewmember to view the EMU boots during EVA workstation and restraint ingress.

The EMU helmet visual performance parameters are presented in Table 11.3-1 (Nash et al., 1982) and the EMU FOV is illustrated in Figure 11.3-1(GIAG-3, 1986).

Table 11.3-1 EMU Helmet Visual Performance

System provision	Parameter	Performance			
Helmet optical visibility	Field of view	120 deg. left and right in the horizontal plane. 105 deg. down and 90 deg. up in the vertical plane			
	Critical area of vision	Vertical	90 deg 1.57 rad		
		Superior-temporal	62 deg 1.08 rad		
		Superior	85 deg 1.48 rad		
		Inferior-temporal	85 deg 1.48 rad		
		Inferior	70 deg 1.22 rad		
Optical distortion	No visible distortion or optical defects detectable by the unaided eye (visual acuity 20/20) at the typical "as worn" position				
Transmittance	Nanometers (nm)	UV	Luminous	IR	
		200	300 400	700 700+	
Thermal/coating optical characteristics	Characteristics	Inner protective visor	Outer sun visor		
	Transmittance				
	550 nm	70% min.	16 ± 4%		
	1100 nm	N/A	10% max.		
	Solar reflectance				
	550 nm	5% max.	40% min.		
	2400 nm	70% min.	N/A		
	700 nm	N/A	55% min.		



The field of view is considerably modified by the protective extravehicular visor assembly (GIAG-3, 1986). However, nothing should obstruct visibility within the critical areas of vision.

Figure 11.3-1 EMU helmet field of view.

11.3.3 Suited Anthropometry

Basic anthropometric dimensions are normally given for shirtsleeve conditions. Anthropometric dimensions for suited crewmembers depend on the specific suit and its response to pressurization. Pressure suits may mask certain shirtsleeve dimensions or introduce new dimensions by their design. Suits may include soft and hard sections, attached or tethered life support systems, and other suit-specific variables that need to be considered when determining anthropometric dimensions. Figure 11.3-2 (Strauss, 2004) is an overview diagram of the Shuttle EMU.

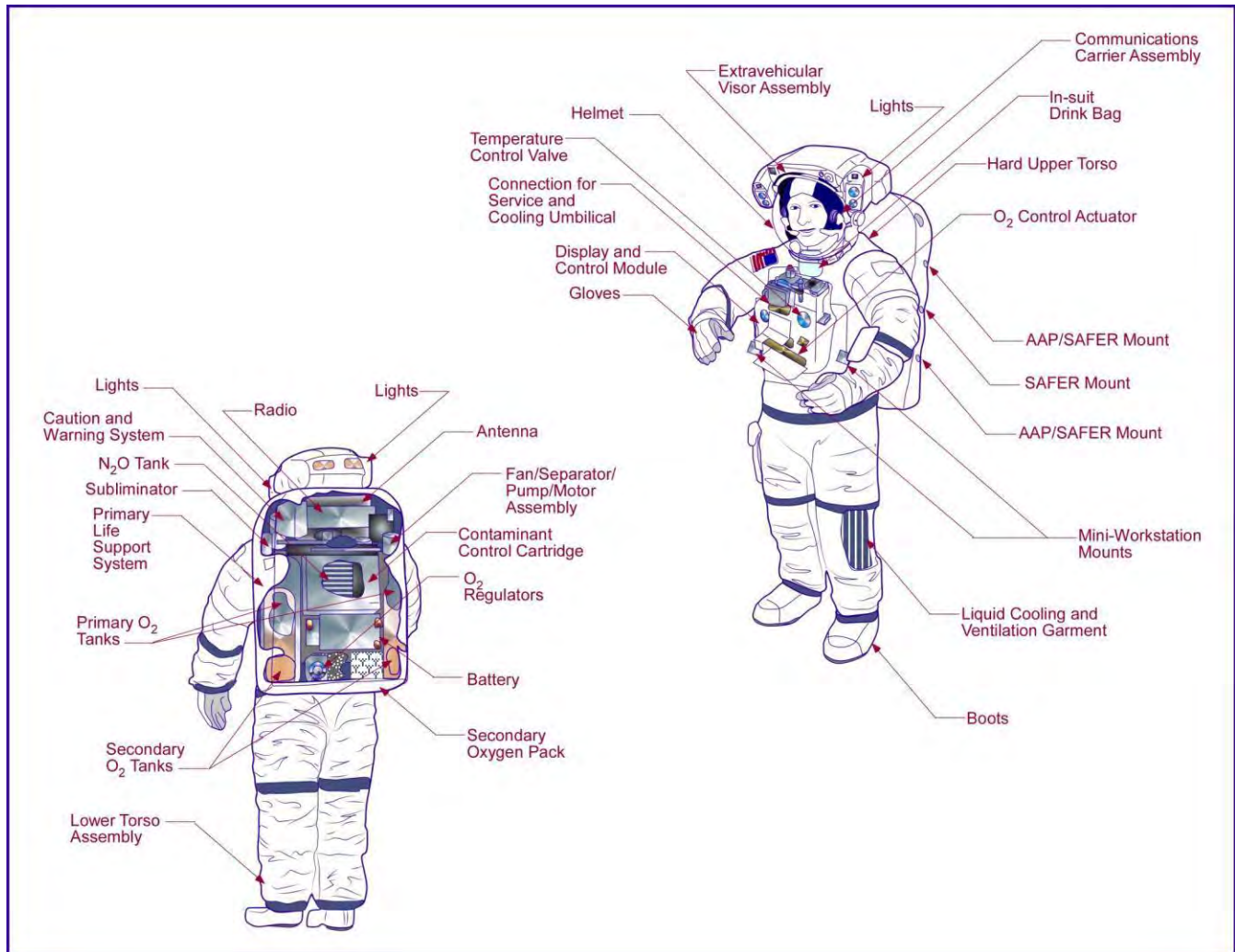


Figure 11.3-2 Extravehicular Mobility Unit.

A pressure suit must accommodate the full anthropometric, range of motion, and strength ranges of the crew. Vehicles, habitats, and interfaces must accommodate the suited crew. Where overlap occurs in IVA and EVA operations, the designers must consider the worst case for both, which includes the smallest shirtsleeve dimensions and largest suited dimensions. See section 4.3 Anthropometry for further discussion.

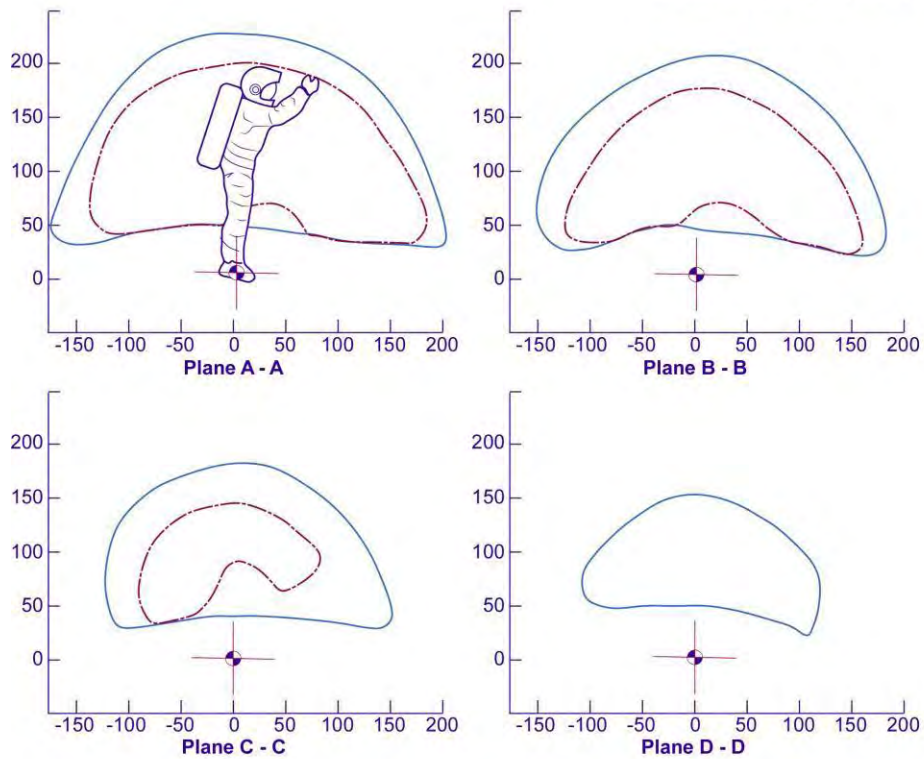
In addition, consideration should be given to how the interfaces between crewmember and suit change in different environments. What may be sufficient suit dimensions in 1g may not be optimized for 0g, where the crewmember will “float” inside the suit, possibly alleviating or creating new pressure points. The EVA crewmember in a 0g environment assumes a position dependent on forces exerted by the spacesuit design. This body position might be different from the shirtsleeve 0g neutral body posture. The suit and crewmember 0g neutral body position needs to be used when designing workstations, panels, controls, and restraints intended for long duration. Designing hardware or operations outside the neutral body posture may be an acceptable design assumption for short periods of time, but prolonged deviation, particularly

when combined with strenuous tasks, should be avoided. Also, the design of suits used for training should consider how neutral buoyancy operations will contribute to suit fit. When inverted in the Neutral Buoyancy Laboratory during training, astronauts have reported shoulder injuries due to the shoulders being pressed up against the hard upper torso when reaching forward or upward (Strauss, 2004).

11.3.4 Suited Reach and Range of Motion

Reach is a function of the anthropometry of the crewmember, the spacesuit design, the nature of the restraint, and the requirement for one- or two-handed operation at the reach limit. EVA tasks should not require an EVA crewmember to approach the limits of reach. Figures 11.3-3 and 11.3-4 depict the Shuttle EMU work envelope as defined by the 5th- and 95th-percentile male crewmember maximum side and forward reach.

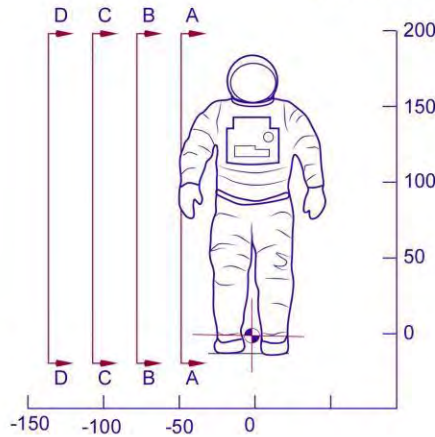
All dimensions are in centimeters



Distance from C/L

- A - A 46cm
- B - B 77cm
- C - C 107cm
- D - D 138cm

- Origin at Center of PFR Bolt Pattern
- PFR Tilted 25° Forward
- Both Feet in Restraints
- Actual Task Requirements Should Not Approach These Limits



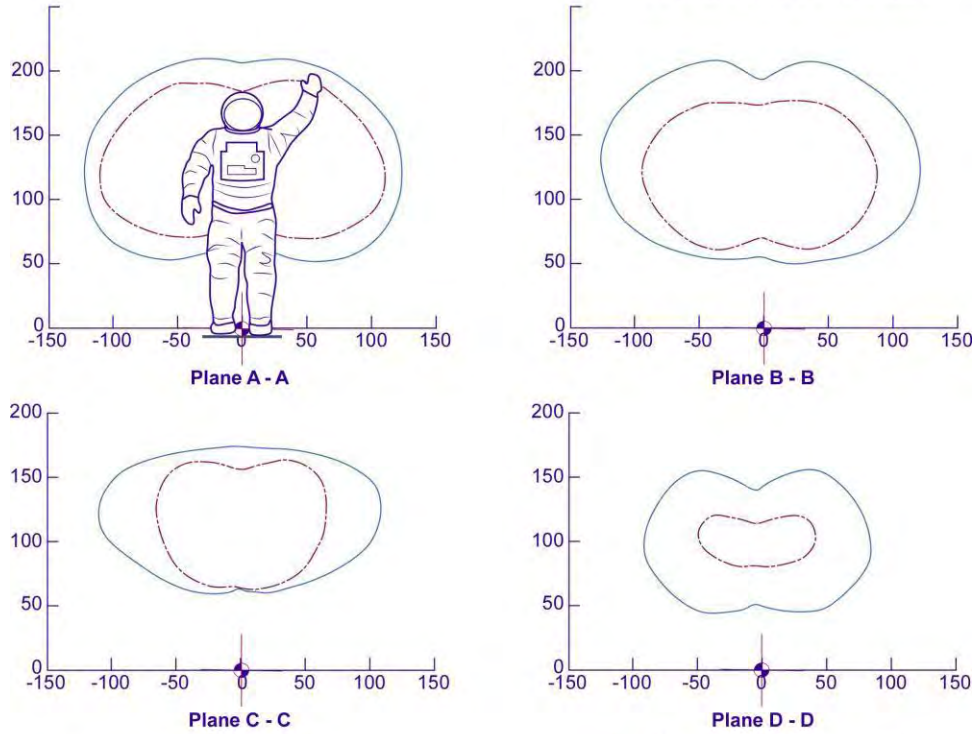
Legend:

Center Line	95th Percentile Male Crewmember Maximum Reach
C/L = Center Line	5th Percentile Male Crewmember Maximum Reach
PFR = Portable Foot Restraint	

C/L = center line; PFR = portable foot restraint

Figure 11.3-3 Maximum side reach envelope.

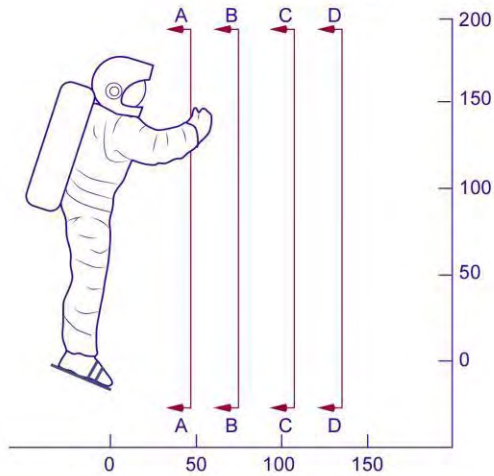
All dimensions are in centimeters



Distance from C/L

- A - A 46cm
- B - B 77cm
- C - C 107cm
- D - D 138cm

- Origin at Center of PFR Bolt Pattern
- PFR Tilted 25° Forward
- Both Feet in Restraints
- Actual Task Requirements Should Not Approach These Limits



Legend:

Center Line	95th Percentile Male Crewmember Maximum Reach
C/L = Center Line	5th Percentile Male Crewmember Maximum Reach
PFR = Portable Foot Restraint	

C/L = center line; PFR = portable foot restraint

Figure 11.3-4 Maximum forward reach envelope.

While pressure suits limit range of motion and mobility due to the pressure across joints and their overall bulkiness, space-suit mobility ranges should be as close to that of shirtsleeve ranges as possible. See section 4.4 Range of Motion for more information.

For 0g EVA operations, the lower body is difficult to maneuver and crewmembers primarily use the upper body and hands for translation from one place to another. The primary function of the boot in 0g is to interface with an EVA foot restraint. For gravity operations, the legs and feet are needed for translation across the ground, and the boot needs to allow the foot to function with a minimum of mobility restrictions and support walking, hopping, and performing weight-bearing tasks.

The range of motion needed for 0g operations differs from that needed during planetary surface operations. In 0g, the feet are either restrained or free-floating, with the feet and legs providing little or no assistance in translation. In a gravity environment, while a planetary surface vehicle (e.g., rover) may be available, the suit must allow locomotor translation on a planetary surface. The type of terrain expected should be considered, including the need to walk up or down a hill, or traverse obstacles such as boulders. In addition, tasks such as climbing ladders or kneeling to collect surface samples should be considered.

The EMU suit components are designed to provide bending and centers of rotation of the mobility joints to approximate the natural body joint movements. The EMU includes mobility joints in the shoulder, elbow, wrist, finger, thumb, waist, hip, knee, and ankle areas, which allow the crewmember freedom of movement in both the pressurized and unpressurized modes.

Spacesuit gloves degrade hand and finger range of motion, tactile feedback, and proficiency compared to bare-hand operations. Depending on the design, dexterity can generally be compared to that with heavy work gloves. However, because of reduced tactile feedback, the size and shape of objects is more difficult to discern. Controls that will be operated by a pressure-suited crewmember must accommodate limited finger and hand range of motion and dexterity. Glove design should provide gloved-hand dexterity as close to bare-hand dexterity as possible.

11.3.5 Suited Strength Performance

Strength capabilities of an EVA crewmember are influenced by the pressure suit design as well as the positioning and restraint of the crewmember at the worksite location.

Strength data collected from minimally clothed humans should be used as guidelines only, as this data indicates trends and orders of magnitude of force output. It is important to verify that the full range of potential EVA crewmembers can perform the physical tasks required by the hardware design and situational configuration refer to section 4.7, Strength, for other considerations pertaining to strength.

Because of the pressurization of the gloves, concerted effort is required to move the arms, hands, and fingers, and repetitive motion can cause hand fatigue and discomfort. This can be minimized with glove design, or with an object's glove interface design, to reduce the need for repetitive finger and hand motion. Tasks such as the manual removal or replacement of threaded fasteners, continuous force-torque application, and extended gripping functions should be minimized in hardware designed for EVA servicing. If such equipment designs are necessary, hardware suppliers need to provide power tools to assist the EVA crewmember. Gloves should also allow

firm retention of items to be grasped, such as handholds, switches, and tools, for short periods of time without hand fatigue.

Overcoming pressure moment and friction forces inherent in the mobility joints of the EMU requires application of force by the crewmember. The joints are designed to approximate neutral stability throughout the full range of motion when pressurized to 4.3 psid (29.6 kPa). The EMU suit-joint neutral stability feature helps to alleviate the requirement to apply a significant counteracting force to maintain a desired position.

11.3.6 Suited Maneuverability

To ensure proper design of the hardware to be used by the crew, current human factors evaluations collect various types of objective and subjective data to determine the usability of the hardware. Objective data have been used to quantify the mobility of space suits; however, these do not cover all aspects of maneuverability. Comments during evaluations support the need to gather subjective data in addition to objective data since they can provide a different point of view on maneuverability. However, none of the existing subjective scales used during these evaluations provide a clear subjective measurement of the ease of movement while executing tasks. In fiscal year 2010 (FY10), a maneuverability scale was developed and modified that can be used to evaluate maneuverability in space suits and confined spaces such as crew quarters (Archer, Sandor, & Holden, 2009). The Maneuverability Assessment Scale (MAS) is a 5-point scale from 1 – very poor to 5 – excellent. Maneuverability is defined as the “ability to move in any direction with the desired pace and accuracy” (see Table 11.3-2).

Table 11.3-2. Maneuverability Assessment Scale Questionnaire

My ability to move in any direction with the desired pace & accuracy is				
<u>Excellent</u>	<u>Good</u>	<u>Fair</u>	<u>Poor</u>	<u>Very Poor</u>
Not affected	Slightly affected	Moderately affected	Significantly affected	Severely affected
1	2	3	4	5

In FY10, the revised MAS was field-tested with 6 subjects in a joint EVA and ORION evaluation of removable hand rails at the JSC Neutral Buoyancy Laboratory in Houston, TX (see Figure 11.3-5). Further studies should be conducted to validate this scale.



Figure 11.3-5 Joint EVA and Orion evaluation in the Neutral Buoyancy laboratory at JSC, Houston, TX.

11.3.7 EVA Crew Restraints

Proper restraint of the EVA crewmember at the workstation is essential for successful 0g EVA operations. Failure to provide adequate restraint can be the single most limiting factor of all EVA design elements. As Michael Collins learned during the Gemini Program, “without some sort of handholds or restraining devices, a large percentage of the astronaut’s time is...devoted to torquing his body around until it is in the proper position to do some useful work” (Collins, 1974). Inadequate restraint induces unnecessarily high workloads and may lead to crew fatigue, overloading of the life-support system, and premature termination of the EVA. Inadequate restraint also increases the potential for equipment damage during EVA operations.

Force application and fine motor skill capability are related to the restraint available at the worksite. There are basically three levels of restraint:

- a. free float, which is unrestrained except with flexible tether(s) and use of hands
- b. restrained with a rigid tether
- c. restrained in a foot restraint

An unrestrained, or free-floating restrained, crewmember can effectively perform only low-force, short-time operations such as actuation of toggle and rotary switches, surveillance of controls and displays, and visual inspections. To exert impulse-type loads, one hand is needed to hold on and one hand to apply the load. Use of a rigid tether allows a crewmember to perform two-handed tasks and relatively low-force activities but with greater control than is possible while free-floating. Very high loads can be applied, similar to shirtsleeve capability, using the foot restraint. These forces are reduced significantly when the point of force application is moved near the top of the crewmember’s reach envelope. This necessitates providing adequate restraint and proper body orientation to the EVA crewmember to optimize force output. Foot restraints have proven to be the most effective means of stabilizing crewmembers and maximizing their capabilities. Even while using foot restraints, a crewmember may use a handrail or other aid at the worksite to provide additional stabilization, additional force application, and restraint while getting into or out of the foot restraint.

The loads that foot restraints can take are limited. The robotic arm (both Shuttle and ISS) will move out of position under high loads. For hard-mounted foot restraints on the ISS, load alleviators protect structures from induced loads, but can also move the crewmember out of position if too much force is applied.

Restraints for each workstation should be selected on the basis of the task to be performed. Tethers and handholds may be adequate for short-term tasks such as inspection and monitoring, but foot restraints should be provided for tasks requiring moderate-to-heavy force application and long-term positioning. The EMU includes two 61-cm (24-in.) waist-safety tethers and a self-retracting 11-m (35-ft) safety tether for translation along the Shuttle payload-bay slide wire.

To reduce EVA workload, preinstalled handholds and handrails should be used when possible. Crew-attached or portable handrails, handholds, and foot restraints should be considered only for non-routine or unplanned EVA workstations. Handholds should also be provided for ingress and egress of foot restraints. Foot restraints must be adjustable to ensure the optimum reach and work envelope of the suited crewmember. On the Shuttle a primary means of restraint is a portable-foot restraint that consists of a foot-restraint platform with position adjustment capability, and an extension arm and a foot-restraint socket that locks into the extension arm (Figure 11.3-6, JSC 20466, 1985).

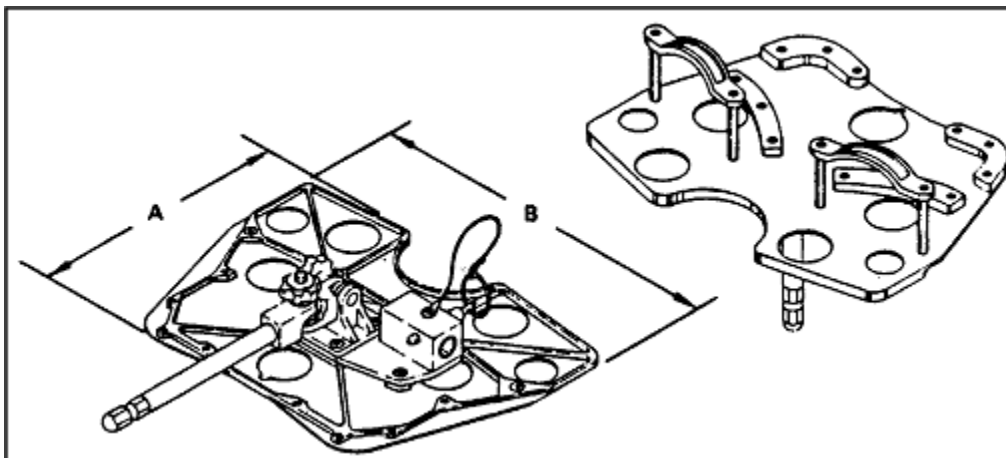


Figure 11.3-6 Shuttle portable foot restraint.

Besides workstation restraint, tethers are used as a safety device during 0g operations, preventing the EVA crewmember from floating away from the spacecraft during translation and working, and should be two-fault tolerant. To prevent inadvertent unlatching, tethers should include latch locks that indicate whether or not they are engaged. There should also be a contingency method for removal of a snagged tether or release of a crewmember from a tether hook. Safety tether attachments should be removable and attachable by one-handed operation.

Restraint design and position should be such that the least number of engagements and disengagements are needed to minimize the risk of failure to attach in 0g. Restraints should be positioned so that a crewmember is restrained or tethered at all times. Consideration should be given to minimizing the crew time required to establish the restraint and to confirm complete engagement.

On a planetary surface, crew restraints should be provided for operations that involve the risk of falling from height, such as from a vehicle platform or ladder.

11.3.8 EVA Mobility Aids

For EVA in 0g, the hands are best suited to provide mobility by grasping objects and moving from one area to another. On the exterior of spacecraft, adequate surfaces to grasp may not be available in the needed locations or objects may be unsafe to touch or susceptible to damage. Mobility aids, such as handholds and handrails, must be provided to ensure safe translation. In some cases, mobility aids and restraints could be provided by the same equipment.

The spacesuit glove should determine the dimensional design of manual mobility aids. Shuttle handrails have a vertical clearance of 5.75 cm (2.26 in.), a horizontal clearance to other objects of 10.16 cm (4 in.), and a length of 15.2 cm (6 in.) to allow the astronauts to grip them while wearing the pressurized EMU glove (Figure 11.3-7, Stokes, 1976). These dimensions will depend on the design of the glove to be used with the mobility aid. Skylab had both single and dual parallel handrails, and the dual handrails were reported to be very easy to use with both hands.

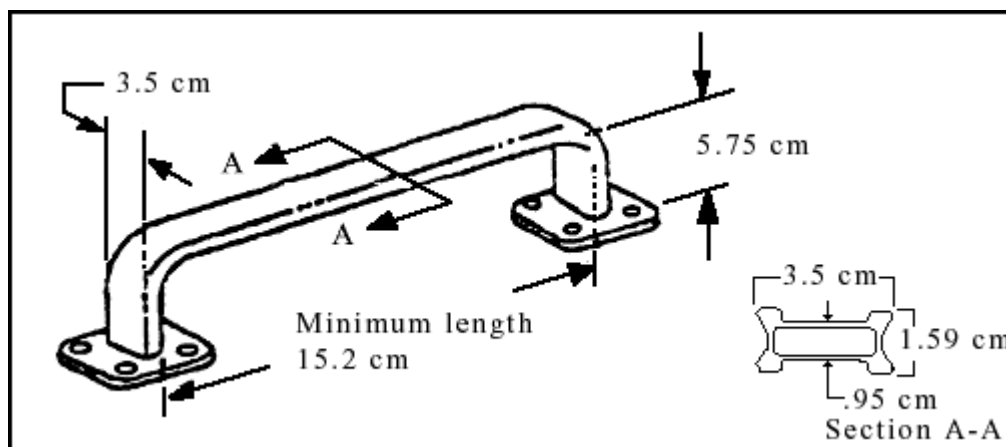


Figure 11.3-7 Shuttle EVA handhold dimensions.

To ensure easy recognition, handholds and handrails should be clearly visible, with a high visual contrast to the background, and be a standard color such as yellow. Handholds and handrails should accommodate crew restraints.

Mobility aids should be located at terminal points and direction change points on established crew translation paths. In addition, mobility aids should be installed in locations to prevent grasping of equipment not intended as a handhold or mobility aid. They should be positioned to support the stability of translation at the expected translation rates and direction changes. A nominal translation rate of 0.5 to 1.0 ft/sec has been observed for unencumbered Shuttle EVA crewmembers.

Translation paths on the Shuttle are along both sills of the payload bay, along the forward and aft bulkheads, and along the centerline (with payload-bay doors closed) for contingencies.

Translation paths to support mission-specific EVAs also may be defined on a mission-by-mission basis. Figure 11.3-8 (JSC 28918, 2005) shows standard Shuttle handrail locations.

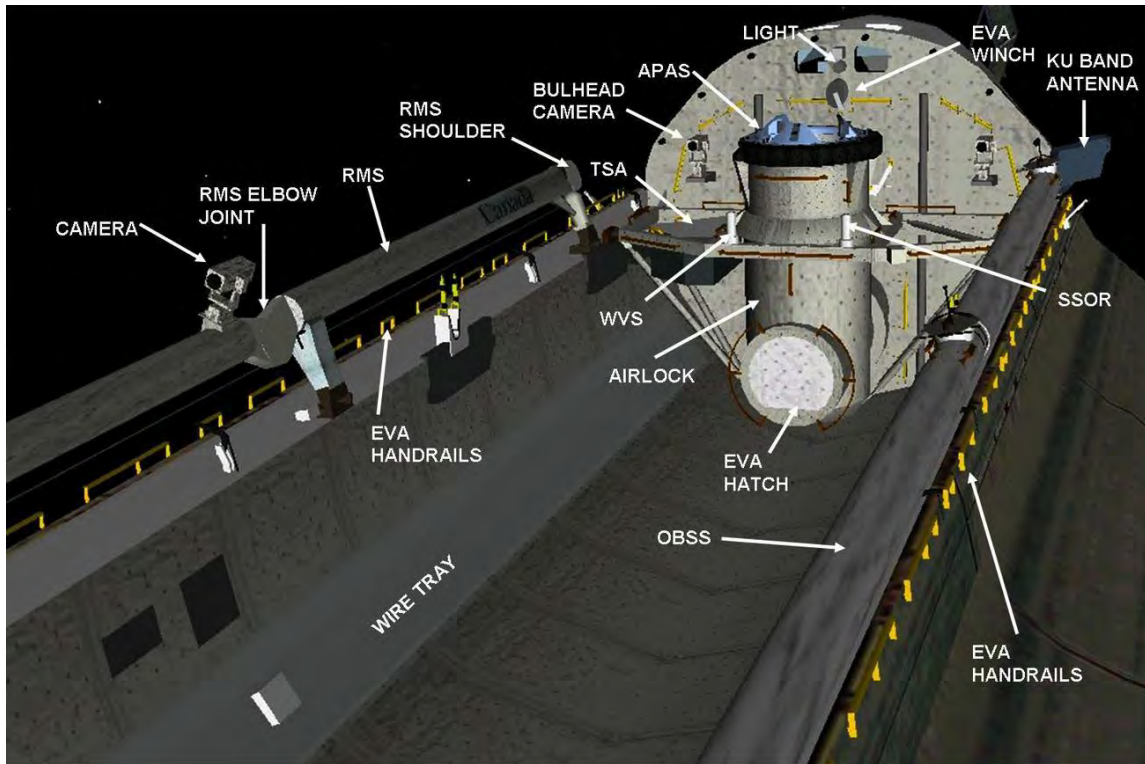


Figure 11.3-8 Standard Shuttle handrail locations.

The design loads for mobility aids and attachments must accommodate the greatest momentum of the largest combination of EVA crew and transported objects (including another injured crewmember).

11.3.9 EVA Translation Paths

Translation paths must accommodate suited crewmembers and their range of motion necessary for translation. Consideration should be given to the size and limited mobility of pressure suits. As shown in Figure 11.3-9, the size of the translation path also depends on the orientation of the crewmember and direction of travel. If the crewmember is traveling in the x-direction (through chest) or y-direction (through shoulders), the translation path is considered a “corridor”; if the crewmember is traveling in the z-direction (through head), the translation path is considered a “tunnel.” These different modes of translation will have different needs for clearance and mobility aids.

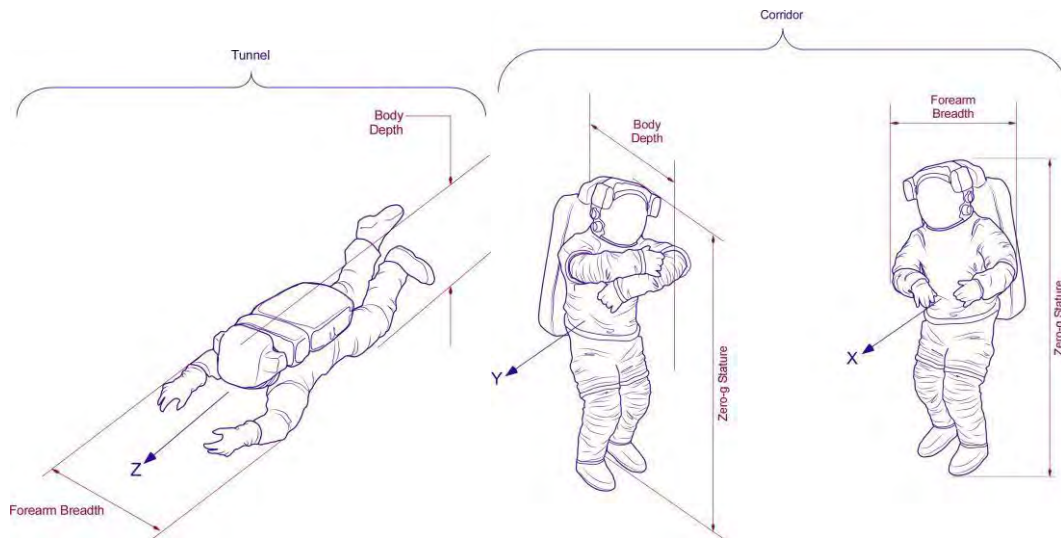


Figure 11.3-9 EVA translation path sizing.

Translation-path dimensions should consider the simultaneous translation of crewmembers along the path, the size of equipment, and the intrusion of mobility aids into the path. Obstructions or equipment should not protrude into the translation path. Consideration should be given to the productivity loss associated with bottlenecks in frequently traveled paths.

11.3.10 Work Efficiency

Work efficiency is a measure of actual work accomplished compared to the overhead of preparing and cleaning up afterwards. For EVA, the preparation includes unstowage, suit checkout, suit donning, prebreathe, airlock depressurization, and egress. Cleanup includes airlock ingress and re-pressurization, suit doffing, and stowage.

EVA work efficiency index (WEI) is defined as:

$$\text{EVA time} / (\text{EVA preparation} + \text{prebreathe} + \text{A/L ops} + \text{EVA post-ops})$$

where A/L = airlock and ops = operations.

EVA operations should have an EVA total WEI of > 1.75, and an EVA day WEI of > 3.0. Increases in EVA WEI can be achieved by minimizing all aspects of the overhead, including prebreathe times. However, prebreathe is a small portion of the total overhead and does not need to be the focus of reduction. For Shuttle operations, oxygen prebreathe time is 18% and 25% of the total and EVA day overhead, respectively. For ISS, prebreathe is 15% and 38% of the total and EVA day overhead. To meet the WEI objective, efficiency improvements should occur in suit checkout, serving, donning, doffing, and post-EVA processing. Many combinations of cabin pressure, suit pressure, and EVA preparation overheads could be integrated to result in the desired WEI. The objective is to ensure that the EVA overhead is minimized through appropriate integrated design of the vehicle and EVA systems.

11.3.11 EVA Acoustics and Noise

The acoustic environment in the suit should provide high-quality audio to and from the crew during EVA, comfortable working noise levels inside the suit, and broadcast-quality audio for

video transmission. See section 6.6 Acoustics for further information on the effects of noise and the acoustic environment. To achieve these objectives, EVA suits will have to be designed from the beginning to produce a minimum of noise; control acoustic resonances in the closed space of the suit; minimize acoustic reflections from the helmet visor; incorporate state-of-the-art microphones, speakers, and electronics; and use high quality digital encoding of the speech and audio.

The inside of the prototype Mark III surface suit is rather loud at 70 dBA SPL, approximately equivalent to standing on a busy street corner. This noise is mostly “hiss” due to the liquid air backpack, bearing noise due to the hip and shoulder bearings, and foot impact noise when walking. Noise at this level harms speech intelligibility and is a source of fatigue for the astronauts. NC-50 must be used during the design process to ensure that levels of noise inside the suit are comfortable.

The life support systems of current EVA suits are sources of noise. Also, the suits have acoustic resonances common to any enclosed volume. Each of these sources of noise and resonances can be controlled by careful attention to the acoustic details of the suit. Noise can be reduced through source or resonance controls.

- Noise Source Control – It is best to modify the designs of the life support systems to eliminate or reduce the noise at the source. This involves measuring noise levels generated by each subsystem early in the design, identifying the sources of noise, and reducing them.
- Resonance Control – When the noise source is minimized, then absorption techniques like mufflers and sound-absorbing foam can be used to further reduce the generated noise to acceptable levels. Resonances of the suit system can be controlled by using sound-absorbing foam, so that the resonances are damped. The helmet is a very reverberant space, and this can make speech communication more difficult.

During tests in 2006 and 2007, the liquid-air backpack was found to be the major source of noise for the Mark III. In particular, the air inlet valve from the liquid-air evaporator produced a loud hiss, which was louder than all the other life support system noises. Tests on the suit system using the laboratory-air supply showed that the noise was not simply due to the airflow across the face plate to scrub out the carbon dioxide. A series of mufflers were designed and tested to see if they could control the noise from the liquid-air backpack, but they were only moderately successful in curtailing the noise.

Noise measurements also showed that the ring-mounted microphones were vulnerable to impact noise, so that the hard-mounted microphones picked up foot impact noise. These microphones also shut off briefly if the footfall is strong enough, which has a negative impact on noise-canceling digital signal processing algorithms. Experiments using elastic band mounts and a new design of microphone on the helmet ring were successful in cutting down on the footfall noise entering the microphone, and the microphones were less likely to shut off due to impact. The microphones on the EVA suit should be soft-mounted to minimize the effect of footfall impact on the audio.

11.3.12 EVA Lighting

11.3.12.1 Orbital EVA Lighting

Most lighting considerations for interior spaces in spacecraft may be extended to the EVA environment. See section 8.7 for general information on lighting. The lighting conditions for EVA operations, however, are generally much more dynamic than those within spacecraft. In low Earth orbit, the surfaces of the vehicle experience a full sunrise-sunset-sunrise cycle about every 90 minutes. Under these conditions, shadows can move across work sites at angular velocities exceeding 4 degrees per minute. Unless large exterior surfaces are adjacent to and angled favorably relative to the work site and the sun, not much reflected “fill” light can be expected to illuminate the deep shadows.

Direct solar illumination in low Earth orbit is on the order of 132,000 lux (lx) (Illuminating Engineering Society of North America (2000). *IESNA Lighting Handbook Ninth Edition*, p.8-5. IESNA). Assuming that Earth's average visual albedo is 0.367

(<http://nssdc.gsfc.nasa.gov/planetary/factsheet/earthfact.html>), “earthshine” reflected from the planet and illuminating the nadir surfaces of a spacecraft in low Earth orbit may be calculated to be about 50,000 lx or less. The earthshine is “diffuse,” originating from all points on the visible planetary disk, with the overall reflected illumination depending on the average reflectance of the surfaces viewed from the spacecraft—ocean, forest, desert, ice, cloud tops, etc. The reflected illumination also depends on the proportion of the planetary body’s surface that appears from orbit to be lighted by the Sun. Similar direct solar illumination levels would be expected for EVAs in lunar orbit, with light-dark periods determined by the orbit altitude and geometry. There is less variation in illumination on the nadir surfaces of a spacecraft during lunar orbit than in Earth orbit, because there is less variation in reflectance over the Moon’s surface than there is in the terrestrial case. Since the average lunar visual albedo is 0.12

(<http://nssdc.gsfc.nasa.gov/planetary/factsheet/moonfact.html>), reflected illumination levels in lunar orbit are a third or less of those in orbit about Earth.

In orbit around Mars, direct solar illumination is approximately 43% of that in low Earth orbit, or about 57,000 lx. Mars’ albedo is 0.15

(<http://nssdc.gsfc.nasa.gov/planetary/factsheet/marsfact.html>), compared with Earth’s value of 0.367. Reflected illumination from Mars’ surface onto a spacecraft in orbit about the planet at an altitude typical of low Earth orbit is calculated to be on the order of 20,000 lx or less.

11.3.12.2 Effects of EVA Helmets on Lighting

The EMU helmet visor attenuates the incident visible light by about 8% to 15%. Some of this loss is attributable to ultraviolet and antireflective coatings necessary to protect the spacefarer from sunburn and to minimize reflected glare inside the helmet. The current external sun visor transmits 16% +/- 4% at 555 nm (Table 11.3-1). If attenuation by the helmet sun visor is not great enough to allow EVA visual tasks to be performed at a particular time, the tasks may need to be shifted in time to periods when adverse solar lighting is not present.

11.3.12.3 Planetary Surface EVA Lighting

Lunar equatorial regions, such as those explored by the Apollo missions, are strongly illuminated by the Sun. The incident sunlight is not scattered by atmospheric dust or moisture, as

encountered on Earth, so shadows on the surface are stark, just as in orbit. There is no aerial perspective (hazy view of distant objects), and the Moon is smaller in diameter than the Earth, so the lunar horizon is nearer to the observer than that on Earth. These effects tend to distort visual distance judgment to make distant objects on the Moon appear closer than they actually are.

The relative uniformity of the surface reflectance and color of the lunar regolith conspire to obscure surface details when they are observed looking in the Sun's direction or with the Sun to one's back. Only when viewed at an oblique angle to the Sun's rays are shadows cast by surface irregularities apparent to afford visual cues to objects' relative size and shape. For this reason, the lunar landing approaches by the Apollo landers were intended to be "cross-Sun."

The lunar south pole has areas of near-constant solar illumination and all lighting is oblique. Certain permanently shadowed features have been identified in this region, including craters near the poles. Elevated features cast very long shadows. Surface exploration by astronauts will require extensive provisions for artificial lighting. Long-term habitations near the southern pole may make use of extensive solar reflectors on elevated surfaces to supply "fill lighting" in some permanently shadowed work areas.

Unlike the Moon, Mars exhibits a day-night cycle similar in length to that of Earth. The thin atmosphere affords a small degree of diffusion to the distance-attenuated solar illumination. The predominant red ochre reflective characteristic of the soil colors all reflected light red. Explorers immersed in this environment for an extended period will likely notice a shift toward less sensitivity to redder light as their color perception adapts to their surroundings. Any color-coded markings for use on Mars should be designed with color adaptation in mind.

11.3.13 Research Needs

RESERVED

11.4 EVA SAFETY

11.4.1 Introduction

While EVA operations include some inherent risks, several hazards of the space environment are potentially more hazardous to EVA crewmembers than to crewmembers inside a spacecraft, and these hazards are described here. These include radiation, chemical contamination, decompression, entrapment, and electrocution.

11.4.2 Radiation

Radiation events, such as solar particle events, may pose a greater danger to EVA crewmembers than their IVA counterparts. This is partly because a suit affords minimal radiation protection compared to a spacecraft, and because taking shelter (e.g., ingress) when an event occurs may take a long time depending on the distance between the crew and the spacecraft or other radiation protection. EVA suits must provide or accommodate radiation monitoring and alerting functions to allow the crew to take appropriate actions.

A personal passive dosimeter is required by the Code of Federal Regulations and Occupational Safety and Health Administration (OSHA) for monitoring astronaut radiation exposure. Providing a stowage location on the EVA suit will minimize crew overhead to don and doff this hardware. The standard passive dosimeters used for ISS/Shuttle/*Mir* by U.S. and Russian scientists are installed inside the pressurized part of the suit. Placing active dosimeters inside the pressurized suit allows the crewmember to select a shielding location that is appropriate for the skin or organ dose that the crewmember is receiving. Current state-of-the-art dosimeters used by U.S. scientists require the presence of oxygen to function properly.

11.4.3 Chemical Contamination

Some EVA worksites or translation paths to worksites will be located on the spacecraft's exterior. These locations may contain hazardous materials to which an EVA crewmember may be exposed. The design of translation paths should avoid contact with potential contamination sources (e.g., jets, engines, fuel lines, fluid purge valves, and gas venting) when possible.

11.4.4 Decompression

In addition to selecting a cabin and suit pressure combination, ppO₂, and prebreathe that result in acceptable DCS risks during nominal operations, provisions for treatment of DCS must be made. This could range from the ability to over-pressurize the suit and/or the spacecraft, to treatment including hyperbaric chambers and/or drug therapy. See section 6.2.2.1.1, Decompression Sickness, for additional information on DCS treatment.

A contingency loss of suit pressure is a serious hazard, leading to injury and eventually death if uncontrolled. The primary causes of suit decompression are likely to be a tear or puncture of the suit's pressure garment, or failure of the suit's environmental control system. Tears and punctures could occur from sharp edges or micrometeoroids.

11.4.4.1 Sharp Edges

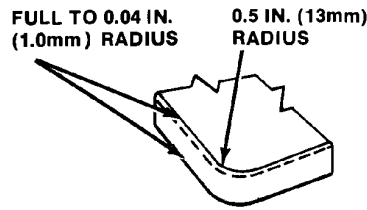
All vehicle and habitat equipment and structures requiring an EVA interface must not have sharp edges or protrusions. If either exists then they must be covered to protect the crew and the crew's critical support equipment. Tables 11.4-1, 11.4-2, and Figure 13.4-1 (JSC 28918, 2005) summarize sharp edge and snag hazard limits for EVA. Operational controls, such as training crewmembers to avoid certain objects, increases mental workload and fatigue, and should not be relied on.

Table 11.4-1 Edge, Corner, and Protrusion Criteria – Edge and In-Plane Corner Radii*

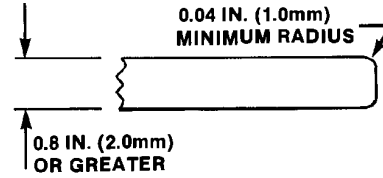
Application	Radius				Remarks	Figure
	Outer in.	mm	Inner in.	mm		
Openings, panels, covers (corner radii in plane of panel)	0.25 0.12	6.4 3.0	0.12 0.06	3.0 1.5	Preferred Minimum	II.2-5 Reference d
Exposed corners	0.5	13	–	–	Minimum	A
Exposed edges: (1) 0.08 in. (2.0 mm) thick or greater	0.04	1.0	–	–		B
(2) 0.02 to 0.08 in. (0.5-2.0 mm) thick	Full radius		–	–		C
(3) less than 0.02 in. (0.5 mm) thick	Rolled or curled					D
Flanges, latches, controls, hinges, and other small hardware operated by the pressurized-gloved hand	0.04	1.0	–	–	Minimum required to prevent glove snagging	–
Small protrusions (less than approximately 3/16 in. [4.8 mm]) on toggle switches, circuit breakers, connectors, latches, and other manipulative devices	0.04	1.0	–	–	Absolute minimum unless protruding corner is greater than 120°	

* A 45-degree chamfer by 0.06 in. (1.5 mm) (minimum) with smooth broken edges is also acceptable in place of a corner radius. The width of chamfer should be selected to approximate the radius corner described above.

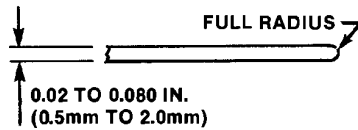
For materials less than 2.032 mm (0.08 in.) thick, used in a location accessible to EVA, edge radii should be greater than 0.0672 mm (0.003 in.). In addition, exposed edges should be uniformly spaced, not to exceed 1.27 cm (0.5 in.) gaps, flush at the exposed surface plane, and shielded from direct EVA interaction.



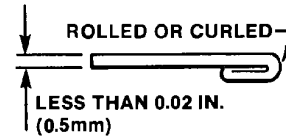
(a) REQUIREMENTS FOR ROUNDING OF CORNERS



(b) REQUIREMENTS OF EXPOSED EDGES 0.08 IN. (2.0mm) THICK OR THICKER



(c) REQUIREMENTS FOR ROUNDING OF EXPOSED EDGES 0.02 TO 0.080 IN. THICK (0.5 TO 2.0mm)



(d) REQUIREMENTS FOR CURLING OF SHEETS LESS THAN 0.02 IN. (0.5mm) THICK

app7g46

Figure 11.4-1 Exposed corner and edge requirements.

Table 11.4-2 Snag and Sharp Edge Hazards

Application	Criteria/Remarks
Latching devices	Cover or design all latching devices to preclude gaps or overhangs that can catch fabrics or pressure-suit appendages.
Sheet metal structure, box and cabinet three-plane intersecting corners	Use spherical welded or formed radii unless corners are protected with covers.
Screw heads, bolts, nuts, nut plates, excess threads, and rivets that a crewmember can come in contact with	<p>Design all screw heads and bolt heads to face the outside of the structure, if possible. Where nuts, nut plates, and threads are exposed, cover the nuts, nut plates, and threads in a secure manner that does not preclude removal of the fastener. Recessed heads or the use of recessed washers is recommended. Overall height of heads must be within 0.125 in. (3.2 mm) or covered unless more than 7 head diameters apart from center to center. Height of roundhead or oval-head screws is not limited. Screw heads or bolt heads more than 0.25 in. (6.4 mm) deep must be recessed or be covered with a fairing, except those intended to be EVA crew interfaces.</p> <p>Design rivet heads to face out on all areas accessible to crewmembers and to protrude no more than 0.06 in. (1.5 mm) unless spaced more than 3.5 head diameters from center to center. In all exposed areas where unset ends of rivets extend more than 0.12 in. (3.1 mm), or unset and diameter if more than 0.12 in. (3.1 mm), install a fairing over them. This applies to rivets such as explosive, blind, and pull rivets. Unset ends of rivets must have edges chamfered 45 deg or ground off to a minimum radius of 0.06 in. (1.5 mm).</p> <p>Allow a maximum gap of 0.02 in. (0.5 mm) only between one side of a fastener head and its mating surface.</p> <p>Prevent or eliminate burrs. Use of Allen heads is preferred. For torque-set, slotted, or Phillips head screws, cover with tape or other protective materials or individually deburr before flight.</p>

11.4.4.2 Micrometeoroid and Orbital Debris Impact

MMOD may range in size from microscopic grains to small rocks and larger rocks. Even microscopic elements can cause significant damage to spacecraft at orbital velocities, and could easily create a tear in a spacesuit and injure the crewmember. The probability of an MMOD penetration of the EMU during a 6-hour, 2-person EVA has been estimated to be 0.0006 (Ellery, A., 2000). While the probability is low, the seriousness of an impact is high enough to warrant consideration of protection during EVA, when a crewmember is most vulnerable. The Shuttle EMU includes a seven-layer micrometeoroid garment of aluminized Mylar laminated with Dacron, topped with a single-layer fabric combination of Gortex, Kevlar, and Nomex.

11.4.5 Entrapment

The limited mobility in a pressure suit may increase the likelihood of an EVA crewmember getting an appendage trapped in a wedge or hole from the size of a gloved finger to that of the whole body. This may become hazardous if the crewmember is not able to slowly and carefully become unencumbered. Because the amounts of consumables in a pressure suit are limited, being trapped too long could be life-threatening. In addition, struggling to become free may damage the suit, including tearing it, which could lead to decompression. To prevent this from occurring, translation paths must be sized to permit a suited crewmember to turn around. Uncovered round or slotted holes must be smaller than the smallest crewmember's finger width or larger than the largest crewmember's finger width. Suit design and operations should be considered when sizing intermediate-sized openings, to preclude entrapment. This also applies to IVA interfaces that may require pressure-suited crewmembers to use them.

11.4.6 Electrical Hazards

The EVA environment may include more numerous and dangerous electrical hazards than the IVA environment, due to the external placement of power sources such as batteries and solar arrays. Preventing contact with electrical hazards can be accomplished by placing electrical contacts out of nominal translation paths, and by placing mobility aids in locations to preclude inadvertent contact with hazards. In the event that maintenance or repair is needed on or near areas that may present an electrical hazard, safe access must be provided, as well as protective covering for any accessible metal suit parts and tools.

During STS-120's visit to the ISS, astronaut Scott Parazynski successfully repaired a damaged solar array during an unplanned EVA. This required the covering of all metal suit and tool surfaces with an insulating (Kapton) tape, careful placement of the astronaut near the solar array using the robotic arm, and the use of a makeshift "hockey stick" to prevent inadvertent contact during repair. See section 9.12.4 for more information on electrical hazards.

11.4.7 Research Needs

RESERVED

11.5 REFERENCES

- Archer, R. D., Sandor, A., & Holden, K. L. (2009). Report on the Maneuverability Assessment Scale: Development, Field Testing and Future Plans. NASA Johnson Space Center, Houston, Texas.
- Chappell, S. P. & Klaus, D. M. (2004). Adaptation of terrestrial mountaineering equipment and training methods for planetary EVA operations. SAE Paper 2004-01-2290. SAE International Conference on Environmental Systems, July 2004, Colorado Springs, CO.
- Chappell, S., Scheuring, R., Jones, J., Lee, P., et al. (2007). Access Systems for Partial Gravity Exploration and Rescue: Results from Prototype Testing in an Analog Environment, International Conference on Environmental Systems, 07ICES-89, Chicago, IL.
- Collins, M. (1974). *Carrying the fire: An astronaut's journeys*. New York: Farrar, Straus & Giroux, reprinted by New York: Bantam Books, 1983.
- Ellery, A. (2000). *An introduction to space robotics*. Heidelberg: Springer.
- GIAG-3 Technical Panel Instructions, Aug. 1986.
- Illuminating Engineering Society of North America (IESNA). (2000). *The IESNA lighting handbook*. Illuminating Engineering Society of North America, NY.
- JSC-20466 (1993). EVA Tools and Equipment Reference Book Rev. B, NASA Johnson Space Center, Houston, Texas.
- JSC 28918 (2005). EVA Design Requirements and Considerations, NASA Johnson Space Center, Houston, Texas.
- Nash, J. D., Wilde, R. C., & King, K. R. (1982). NASA-CR-167614: Study of EVA Operations Associated with Satellite Services. Hamilton Standard, Windsor Locks, CO.
- Scheuring, R. A., Jones, J. A., Polk, J. D., et al. (2007). The Apollo Medical Operations Project: Recommendations to Improve Crew Health and Performance for Future Exploration Missions and Lunar Surface Operations. NASA/TM-2007-214755; S-1005, NASA Johnson Space Center, Houston, Texas.
- Strauss, S. (2004). Extravehicular Mobility Unit Training Suit Symptom Study Report. NASA/TP-2004-212075, NASA Johnson Space Center, Houston, Texas.
- Stokes, J. W. (1976). MSFC-STD-512A: Man/System Requirements for Weightless Environments. AiResearch Mfg Co., Los Angeles, CA.
- Wein, A. J., Kavoussi, L. R., Novick, A. C., Partin, A. W., & Peters, C. A. (2007). In Campbell-Walsh (Ed.) *Urology* (9th ed.). Philadelphia, PA: Saunders-Elsevier.
- Wissler E. H. (1986). Simulation of Fluid-Cooled or Heated Garments that Allow Man to Function in Hostile Environments. *Chemical Engineering Science*, 41, 1689–98.

APPENDIX A – ABBREVIATIONS AND DEFINITIONS

ABBREVIATIONS, INCLUDING ACRONYMS

ϕ	azimuthal viewing direction
θ	polar declination angle
Ω	omega
μg	microgram
μm	micrometer
μPa	micropascal
0g	zero gravity
2D	two-dimensional
3D	three-dimensional
AC	advanced chat
ac	alternating current
ACES	Advanced Crew Escape Suit
ACGIH	American Conference of Governmental Industrial Hygienists
ACSM	American College of Sports Medicine
ACT-R	Atomic Component of Thought – Rationale
AEL	accessible emission limits
AFB	Air Force Base
AGARD	Advisory Group for Aerospace Research and Development (NATO)
AGE	arterial gas embolism
AGILE	Assessment of Gravito-Inertial Loads Environment
AGS	anti-g suit
AGSM	anti-g straining maneuver
Air MIDAS	Air Man-Machine Integration Design and Analysis System
ALARA	as low as reasonably achievable
ALT	altitude
AMBR	Agent-Based Model Representation
AMLCD	active matrix LCD
AMRL	Aerospace Medical Research Laboratory
AMS	acute mountain sickness
ANAM	Automated Neuropsychological Assessment
ANSI	American National Standards Institute
ANSUR	Anthropometric Survey
APA	American Psychological Association
ATAGS	Advanced Tactical Anti-g Suit
ATC	air traffic control
ATP	adenosine triphosphate
ATT	attitude
ATU	audio terminal unit
ATV	Automated Transfer Vehicle
ARS	Atmosphere Revitalization System

ASA-SEEV	Attention-Situation Awareness - salient, effort, expectancy, valuable
BEI	biological exposure index
BET	blur edge time
BEW	blur edge width
BFO	blood-forming organs
BLEEX	Berkeley Lower Extremity Exoskeleton
bpm	beats per minute
BSL	biosafety level
BTA	Bends Treatment Apparatus
BTU	British thermal unit
Bq	becquerel
C	Celsius
C&W	caution and warning (alerts)
CAD	computer-aided drafting
CAESAR	Civilian American and European Surface Anthropometry Resource
cal	Calorie
CANTAB	Cambridge Neuropsychological Test Automated Battery
cc	cubic centimeter
CCT	correlated color temperature
CE	Combined Advanced Technology Enhanced Design G-Ensemble
CEO	Crew Earth Observations
CEV	Crew Exploration Vehicle
CEVIS	Cycle Ergometer with Vibration Isolation System
CFE	contractor-furnished equipment
CFF	critical fusion frequency
CFR	Code of Federal Regulations
CFU	colony-forming units
Ci	curie
CIE	Commission Internationale de L'Eclairage
cm	centimeter
CM	Command Module
CM	computer-mediated
CM	Crew Module
CME	coronal mass ejection
CMO	Chief Medical Officer
CNS	central nervous system
CO	carbon monoxide
CO ₂	carbon dioxide
CoA	course of action
COGNET/iGEN™	Cognition as a Network of Tasks/ iGEN™
COMBAT EDGE	Combined Advanced Technology Enhanced Design G-Ensemble
COTS	commercial off-the-shelf
C _p	peak image contrast

CPR	cardiopulmonary resuscitation
CPS	Condensation Prevention System
CPS	critical print size
CPT	Continuous Performance Test
C_M	Michelson contrast
C_R	contrast ratio
CRM	Crew Resource Management
CRT	cathode ray tube
CSA-CP	Compound Specific Analyzer – Combustion Products
CSF	Contrast Sensitivity Function
cSV	centisievert
CTB	Cargo Transfer Bags
CVA	Clear Viewing Aperture
CVCM	Collected Volatile Condensable Material
CW	continuous-wave
CWC	Contingency Water Container
CxP	Constellation Program
D	distance
dB	decibel
dBA	decibels adjusted
dc	direct current
DCS	decompression sickness
DDREF	dose rate effectiveness factor
DGR	discomfort glare rating
dia	diameter
DLP	Digital Light Processing
DMD	Digital Micro-mirror Device
DNA	deoxyribonucleic acid
D_o	dose of radiation that kills 37% of cells
DoD	Department of Defense
DOF	Degrees of Freedom
D-OMAR	Distributed Operator Model Architecture
D_p	viewing distance
dpi	dots per inch
DR	dynamic response
DTL	Dynamic Task List
DV	dorsoventral
E	illuminance (photometric) or irradiance (radiometric)
E3	electromagnetic environmental effects
EA WG	Exploration Atmosphere Working Group
ECG	electrocardiogram
ECLS	Environmental Control and Life Support
ECLSS	Environmental Control and Life Support Subsystem
EDE	effective dose equivalent
EDOMP	Extended Duration Orbiter Medical Project

EER	estimated energy requirements
EL	electroluminescent (display)
ELF	extremely low frequency
EM	electromagnetic
EMI	electromagnetic interference
EMU	Extravehicular Mobility Unit
EPA	Environmental Protection Agency
EPIC-Soar	Executive Process-Interactive Control - Soar
ERB	equivalent rectangular bandwidth
EVA	extravehicular activity
EVOH	ethylene vinyl alcohol
F	Fahrenheit
FAA	Federal Aviation Administration
fc	foot-candles
FCE	Flight Crew Equipment
FED	field emission display
FFM	Five Factor Model
FFT	fast Fourier transform
FFTD	Fluid Fitting Torque Device
FOD	foreign object debris
FORP	Fuel-Oxydizer Reaction Product
FOV	field of view
ft	foot
FTF	face-to-face
FPDM	Flat Panel Display Measurement
g	gram
g	gravity or acceleration (9.8 m/s ²)
G _{x,y,z}	acceleration in the x,y, or z direction
g/s	g per second (where “g” equals 9.8 meters per second squared)
GCR	galactic cosmic ray (radiation)
GFE	Government-furnished equipment
GHz	gigahertz
G-LOC	gravity-induced loss of consciousness
GLV	grating light valve
GMA	general mental ability
GSE	ground support equipment
GUI	graphical user interface
Gy	Gray
Gy-Eq	Gray equivalent
H	dose equivalent
H	height
HCI	human-computer interaction
HCl	hydrogen chloride
HCN	hydrogen cyanide
HDTV	high-definition television

HEPA	high-efficiency particulate air
HFES	Human Factors and Ergonomics Society
HIDH	Human Integration Design Handbook
HL	hearing level
HLA	high-level architecture
HMD	head-mounted display
HMI	human-machine interaction
HPD	hearing protection device
HPM	human performance models
HQR	Handling Qualities Rating
h	hour
HRI	human-robot interaction
HSIR	Human-Systems Integration Requirements
HST	Hubble Space Telescope
HUD	head-up display
HUT	hard upper torso
HVAC	heating, ventilation, and air conditioning
HVS	human visual system
Hz	hertz
HZE	high atomic number and energy
I	luminous intensity, or radiometric intensity
IA	inter-aural
ICD	Interface Control Document
ICDM	International Committee on Display Metrology
ICES	International Conference on Environmental Systems
IEEE	Institute of Electrical and Electronics Engineers, Inc.
IESNA	Illuminating Engineering Society of North America
IID	interaural intensity differences
iMOD	Interferometric Modulator Display
IMPRINT	Improved Performance Research Integration Tool
IMS	Inventory Management System
in	inch
IR	infrared
IRD	Interface Requirements Document
iRED	Interim Resistive Exercise Device
ISRU	in situ resource utilization
ISO	International Standards Organization
ISS	International Space Station
IST	interpersonal skill training
ITD	interaural time difference
IVA	intravehicular activity
J	joule
JND	just noticeable difference
JSC	Johnson Space Center
keV	kilo electron volt(s)

kg	kilogram
kHz	kilohertz
kJ	kilojoules
KSC	Kennedy Space Center
L-	launch minus (a number of days)
L	length
L	liter(s)
L(x,y)	luminance image
lbf	pound force
LBNP	lower-body negative pressure
lb	pound(s)
LCD	liquid crystal display
LCG	Liquid Cooling Garment
LCS	Laser Camera System
LCVG	Liquid Cooling and Ventilation Garment
LDFR	Long-Duration Foot Restraint
LED	light-emitting diode
LEO	low Earth orbit
L_{eq}	equivalent (continuous) sound level
LET	linear energy transfer
LDRI	Laser Dynamic Range Imager
LGN	lateral geniculate nucleus
LIRS	Low Iodine Residual System
L_k	luminance of black
lm	lumen(s)
LM	Landing Module
L_{max}	maximum luminance
L_{min}	minimum luminance
LMD	light measurement device
L_o	background luminance
LOC	loss of crew
LOM	loss of mission
LRU	Line Replacement Unit
L_w	luminance of white
lx	lux
m	meter
MAA	minimum audible angle
MAF	minimum audible field
MAG	Maximum Absorbency Garment
MAMA	minimum audible movement angle
MAP	minimum audible pressure
MCC	Mission Control Center
MCH	Modified Cooper-Harper
MCI	mild cognitive impairment
MCL	maximum contaminant levels

MD	Modifications Director
MDA	Multiple Docking Adapter
MDF	minimum duration flight
MEMS	microelectromechanical system
MER	Mars Excursion Rover
Metox	metal oxide
MeV	mega electron volt
mg	milligram
mGy	milligray
mHz	millihertz
MHz	Megahertz
MIDAS	Man-machine Integration Design and Analysis System
min	minute
mL	milliliter
mm	millimeter
MM	micrometeorite
mmHg	millimeter(s) of mercury
MMOD	micrometeoroids and orbital debris
MPE	maximum permissible exposures
MRAB	MiniCog Rapid Assessment Battery
MRE	Meal Ready to Eat
ms	millisecond
MSFC	Marshall Space Flight Center
MSIS	Man-Systems Integration Standards
mSv	millisievert
MTF	Modulation Transfer Function
MWL	mental workload
N	newton
N ₂	nitrogen (molecular)
NASA	National Aeronautics and Space Administration
NASA-TLX	National Aeronautics and Space Administration Task Load Index
NBL	Neutral Buoyancy Laboratory
NCRP	National Council on Radiation Protection and Measurements
NHANES	National Health and Nutrition Examination Survey
NHV	net habitable volume
NIHL	noise-induced hearing loss
NIOSH	National Institute for Occupational Safety and Health
NIR	non-ionizing radiation
NIST	National Institute of Standards and Testing
nm	nanometer
nm	nautical mile
NO	naso-occipital
NO ₂	nitrate
NO ₃	nitrite
NOLS	NASA Outdoor Leadership School

NRC	National Research Council
NTU	nephelometric turbidity unit
O ₂	oxygen (molecular)
OASPL	overall sound pressure level
OBSS	Orbital Boom Sensor System
OCAC	Orbiter Cabin Air Cleaner
OCR	ocular counter-roll
OD	orbital debris
OKR	optokinetic reflex
OLED	organic light-emitting diode
OpNom	operational nomenclature
OpsHab	operational habitability
ORU	Orbital Replacement Unit
OSHA	Occupational Safety and Health Administration
OTTR	otolith tilt-translation reinterpretation
OWS	Orbital Work Station
oz	ounce
Pa	pascal
PAWS	NASA Performance Assessment Workstation
PCU	platinum-cobalt unit
PDA	personal digital assistant
PDP	plasma display panel
PERS	Payload Equipment Restraint System
PFE	portable fire extinguisher
PFR	Portable Foot Restraint
pg	page
PLED	polymer light-emitting diode
POSWAT	Pilot Objective/Subjective Workload Assessment Technique
PPB	positive-pressure breathing
ppCO ₂	partial pressure of carbon dioxide
PPE	personal protective equipment
ppN ₂	partial pressure of nitrogen
ppO ₂	partial pressure of oxygen
PSF	performance-shaping factors
psi	pound per square inch
psia	pound per square inch absolute
psid	pound per square inch differential
psig	pound per square inch gauge
PSS	Performance Support System
PW	pulsed wave
PWM	pulse width modulation
Q	quality factor
QCM	quartz crystal microbalance
QD	quick disconnect
rad	radian(s)

RBE	radiobiological effectiveness
RCS	Reaction Control System
REID	risk of exposure-induced death
RER	respiratory exchange ratio
RF	radio frequency
RFID	radio frequency identification
RH	relative humidity
RHO	radiation health officer
rms	root mean square
RMS	Remote Manipulator System
RPD	recognition-primed decision
RPM	revolutions per minute
RT	response time
RTG	Radioisotopic Thermoelectric Generator
RVOR	rotational VOR
s	second
SA	situational awareness
SAA	South Atlantic Anomaly
SAIR	Software Avionics Interoperability Reuse
SAP	Science Activity Planner
SCAPE	Self-Contained Atmosphere Protective Ensemble
SCSF	spatial contrast sensitivity function
SCUBA	Self-Contained Underwater Breathing Apparatus
SD	spatial disorientation
SEBS	Spacehab Emergency Breathing System
SED	Surface Conduction Electron Emitter Display
SFHSS	Space Flight Human Systems Standard
SFOG	Solid Fuel Oxygen Generator
SFU	solar flux units
SI	Système international d'unités (international system of units)
SID	Society for Information Display
SLM	Spatial Light Modulator
SM	Service Module
SMAC	spacecraft maximum allowable concentration
SME	subject matter expert
SMM	shared mental model
SMS	space motion sickness
SPD	spectral power distribution
SPE	solar particle event
SPL	sound pressure level
sq	square
SQRI	square-root integral
sr	steradian(s)
sRGB	standard red-green-blue
SRP	seat reference point

SSO	spatial standard observer
SSP	Space Shuttle Program
STCSF	spatio-temporal contrast sensitivity function
STPD	standard temperature and pressure, dry (temperature and dry gas at standard barometric pressure: 0 °C, 101.3 kPa, dry)
STS	Space Transportation System
Sv	sievert
SWAT	Subjective Workload Assessment Technique
SWEG	spacecraft water exposure guideline
SWV	split window view
T2	second-generation ISS treadmill
TACT	Team Adaptation and Coordination Training
TBD	to be determined
TBR	to be resolved
T _c	contact temperature
TCSF	temporal contrast sensitivity function
TDT	Team Dimensional Training
TEE	total energy expenditure
TEM	threat and error management
TEPC	Tissue Equivalent Proportional Counter
TFEL	thin film electroluminescent
TFT	thin film transistor
TLAP	timeline analysis procedure
TLD	thermoluminescent detector
TLV	threshold limit value
TLX	task load index
T _o	object temperature
TOC	total organic carbon
TOCA	Total Organic Carbon Analyzer
TON	threshold odor number
TOVA	Test of Variables of Attention
T _s	skin temperature
TSAS	tactile situation-awareness system
TT	treatment technique
TTN	threshold taste number
TTS	Tilt-Translation Sled
TV	television
TVIS	Treadmill with Vibration Isolation System
TVOR	translational VOR
TWA	time-weighted average
UGR	unified glare rating
UID	user interface design
U. S.	United States
USAF	United States Air Force
USEPA	United States Environmental Protection Agency

UV	ultraviolet
V	visual resolution
VCE	visible contrast energy
VCR	vestibulocollic reflex
VCP	visual comfort probability
VESA	Video Electronics Standards Association
VFD	vacuum fluorescent display
VMC	visual meteorological conditions
VO ₂ max	maximal oxygen consumption
VOA	Volatile Organic Analyzer
VOL	volume
VOR	vestibulo-ocular reflex
VOX	voice activation mode
VR	verification requirement
VRMS	volts, root mean square
VSE	Vision for Space Exploration
VSR	vestibulospinal reflex
W	watt(s)
W	width
WCST	Wisconsin Card Sorting Test
WEI	work efficiency index
WORF	Window Observational Research Facility
W _t	tissue weighting factor
Z	atomic number

DEFINITIONS

Term	Definition
Abort	Termination of the mission or mission phase before the mission destination is reached, because of a failure or other condition that endangers the crew. At the moment an abort is declared, the focus of the operation switches from flying the planned mission to saving the crew. A successful abort ultimately places the crew in the portion of the space flight system normally used for reentry, and places them in a safe situation suitable for successful return and rescue. Aborts include scenarios in which the vehicle is damaged or not recovered.
Accessible	An item is considered accessible when it can be operated, manipulated, serviced, removed, or replaced by the suitably clothed and equipped user with applicable body dimensions conforming to the anthropometric range and database specified by the procuring activity, or if not specified by the procuring activity, with applicable 5 th - to 95 th -percentile body dimensions. Applicable body dimensions are dimensions that are design-critical to the operation, manipulation, removal, or replacement task.

Term	Definition
Activity center	A specific location uniquely configured for a human activity, such as personal hygiene, body waste, food, sleep, trash, stowage, exercise countermeasures.
Advanced life support	<p>For the Constellation Program, “advanced life support” is defined as the level of medical care that provides the capability to stabilize and/or reverse a life-threatening illness or injury as defined by the following criteria:</p> <ul style="list-style-type: none"> a. Unstable vital signs (heart rate <42 or >100, respiratory rate <8 or >30, systolic blood pressure <90 or >200, pulse oximetry <90% on room air, signs of confusion, pallor, extreme pain, or altered mental status). b. Use of an artificial airway, assisted breathing device, or ventilator. c. Need for any intravenous drug infusion(s). d. Recent or anticipated use of defibrillator, cardioversion, or transcutaneous pacing. e. Need for continuous physiological monitoring. f. Need for continuous monitoring and care by another crewmember. g. Failure of one or more organ system(s). <p>Examples of “Advanced Life Support” hardware are a respiratory support device, intravenous pharmaceuticals and fluids, and defibrillation devices.</p>
Affect	Observable behavior that represents the expression of a subjectively experienced feeling state (mood, morale). Common examples of affect are sadness, fear, joy, and anger. The normal range of expressed affect varies considerably between different cultures and even within the same culture.
Affective	Pertaining to feelings and changes in emotions, interest, attitudes, acceptance, appreciations, adjustments, and values. Includes attending, responding, valuing, organization, and characterization by a value or value complex.

Term	Definition
Ambulatory care	<p>The level of medical care that a crewmember can independently provide to himself or herself. The flight surgeon might be consulted, but no complex interventions or assistance from other crewmembers are needed. Many of the conditions that require “ambulatory care” are minor ailments that would be likely to resolve eventually even in the absence of treatment, but may still in the interim have significant mission impact. In addition, it should be noted that if a minor ailment is not properly diagnosed and treated in its initial stages, it may progress to a much more severe condition; e.g., bronchitis if untreated may become pneumonia, a bladder infection if untreated may lead to a kidney infection (pyelonephritis) or sepsis. Criteria for “ambulatory care” are defined as</p> <ol style="list-style-type: none"> a. Administration of oral or topical medications b. No more than one procedure required for resolution of condition (example: single dose of intravenous medication or reduction of dislocation). c. Ability to perform the majority of scheduled mission tasks.
Anthropogenic	Induced or altered by the presence of humans.
Anthropometry	The science of measuring the human body and its parts and functional capabilities. Includes lengths, circumferences, body mass, and so on.
Atelectasis	A state in which the lung, in whole or in part, is collapsed or without air.
Attenuation	Diminution in force or intensity of sound.
Auditory annunciation	An audible computer-generated speech or non-speech signal. Examples are an emergency klaxon and a speech-based message.
Basic life support	The level of medical care that provides the capability for cardiopulmonary resuscitation (CPR), basic airway management, and crew immobilization.
Biofilm	A thin layer of microorganisms (as bacteria) that forms on and coats various surfaces (as of water pipes and catheters)
Biomechanics	The study of the principles and relationships involved with muscular activity.
Birefringence	Refers to the difference in index of refraction that is a function of incident light polarization. Birefringence can be an intrinsic material property such as in sapphire, or be induced by stress in a material that otherwise does not display birefringence.

Term	Definition
Bubbles	Gaseous voids, of generally circular cross section, that are entrapped within a bulk material, such as glass, plastics, or laminates, usually as a result of the manufacturing process.
Candela	Candela is the unit of luminous intensity. One candela equals the flux distribution of 1 lumen per steradian of solid angle.
Catastrophic hazard	A condition that may cause loss of life, permanently disabling injury, or loss of flight assets.
Clear viewing aperture	The area of a window that is not covered by the window assembly frame or other structure that would block incident light rays.
Clinical diagnostics	The level of medical care that provides the capability for assessing vital signs and medical conditions and reaching a clinical diagnosis. Examples of “clinical diagnostics” hardware are stethoscope, thermometer, blood pressure cuff, urine chemistry strips, and portable limited body fluid analyzer.
Cognitive	Pertaining to the mental processes of perception, learning, memory, comprehension, judgment, and reasoning.
Concept of Operations	A Concept of Operations (ConOps) is developed (by a program or project) for all mission scenarios to describe how mission objectives will be accomplished using planned resources, including crew and system.
Contamination	The act of rendering unfit for use by the introduction of unwholesome or undesirable elements.
Contingency EVA	An EVA performed to deal with critical failures or circumstances, which are not adequately protected by redundancy or other means; an EVA not scheduled in the pre-mission timeline but needed in order to lower risks to the safety of the crew or the outpost, and/or the safe return of the vehicle.
Contrast	The ratio of the luminance of the brightest white to the darkest black.
Countermeasure	A measure or means calculated to counter, check, or offset another effect, such as the use of exercise or pharmaceuticals to relieve the effects of zero gravity (0g), or the use of specialized clothing to reduce the effects of acceleration forces.
Crew	Human team of one or more members on board a spacecraft during a mission.

Term	Definition
Crew interface	Any part of a spacecraft through which information is transferred between the crew and the spacecraft, whether by sight, sound, or touch. Usable, well-designed crew interfaces are critical for crew safety and productivity, and minimize training requirements.
Crew station	A location in a spacecraft where crewmembers perform an activity.
Crew survival	Ability to keep the crew alive using capabilities such as abort, escape, safe haven, emergency egress, and rescue in response to an imminent catastrophic condition.
Crew survival capabilities	Capabilities incorporated into program architecture and operations to preserve the lives of crewmembers in the presence of imminent catastrophic conditions. Examples are abort, escape, and safe haven.
Crewmember	Human on board the spacecraft during a mission.
Critical hazard	A condition that may cause severe or lost-time injury or incapacitation, or major damage to flight assets, or loss of Program-critical assets, or loss of primary mission objectives.
Data accuracy	The degree to which information in a digital database matches true or accepted values. Accuracy is an issue pertaining to the quality of data and the number of errors contained in a dataset.
Data fidelity	Data qualities that include accuracy, precision, reliability, latency (data freshness), resolution, and completeness.
Data precision	The level of measurement and exactness of description in a database. Precise locational data may measure position to a fraction of a unit. Precise attribute information may specify the characteristics of features in great detail. Note that precise data, no matter how carefully measured, may be inaccurate.
Data reliability	The degree to which data is the same when sampled repeatedly.
Decompression	The act or process of reduction of pressure, as occurs when compressed air is released from a spacecraft to the vacuum of space.
Decompression sickness (DCS)	A sickness induced by too rapid a decrease in air pressure after a stay at a higher air pressure and caused by nitrogen bubbles forming in blood and tissues.

Term	Definition
Deconditioned crew (deconditioning)	The loss of fitness due to exposure to the conditions of space flight. Areas of fitness affected include muscles, skeleton, and the vascular system. Deleterious conditions of space flight include 0g, confinement, isolation, and stress.
Dental care	The level of medical care that provides the capability to diagnose and treat oral and dental conditions. Examples of “dental care” hardware are temporary fillings and crowns, tooth extraction hardware, and abscess drainage hardware.
Deviation	Deviation refers to the angle that an emergent ray of light makes with the incident ray as it passes through a window pane or port, or other optical device.
Dig	A small rough spot or short scratch on a polished surface, generally residuals of subsurface damage caused by grinding that did not polish out or by bubbles that opened up, whose dimensions are sufficient to be measured.
Diffuse reflection	The fraction of incident light or other type of wave within a specified wavelength band that is reflected from a surface uniformly in all directions, regardless of the angle of incidence of the incident light (rays or wave). A truly diffusely (Lambertian) reflective surface has the same luminance (appears to have the same brightness) from all viewpoints, regardless of the direction of the source relative to the surface. This type of reflection is associated with matte or “flat” surface treatments on objects, and is contrasted with specular reflectance. Most surfaces exhibit a combination of specular and diffuse reflectance.
Display	All of the visual, aural, and tactile information or feedback presented to crewmembers via a device such as a label, computer monitor, or headphones.
Display device	The hardware used to present visual, aural, and tactile information to crewmembers or ground operations personnel. Display devices include computer monitors and personal digital assistants (PDA).
Distortion	A term referring to the situation in which an image is not a true-to-scale reproduction of an object and the resultant image looks misshapen because of a changing wedge angle between two windowpane surfaces or material inhomogeneities or irregularities in the optical surface.

Term	Definition
Effective dose	A calculated, not measured, quantity. The effective dose is an estimate of the uniform whole-body equivalent dose that would produce the same level of risk for adverse effects that results from nonuniform partial-body irradiation. The unit for the effective dose is the sievert (Sv).
Emergency systems	Safeguards against hazardous situations that directly affect crewmembers that would be used for the prevention of loss of life. Examples are abort systems, fire suppression systems, and crew escape systems. Emergency systems are not a leg of fault tolerance.
Error	A procedural omission (including incompleteness), addition, or substitution beyond the accepted procedure. Performance outside the acceptable range (including inaccuracy and time standards) of a desired target in a task.
Escape	In-flight removal of the crew from the portion of a space system normally used for reentry, because of rapidly deteriorating and hazardous conditions, thus placing them in a safe situation suitable for survivable return or recovery. Escape includes, but is not limited to, capabilities that utilize a portion (e.g., pods, modules, or forebodies) of the original space system for the removal. (NPR: 8705.2A, Human-Rating Requirements For Space Systems)
Extravehicular activity (EVA)	Operations performed by suited crewmembers outside the pressurized environment of a spacecraft (during space flight or on a destination surface). Includes off-nominal operations performed inside unpressurized spacecraft.
Field of view for windows	All points that can be viewed through a window directly by at least one eye, given the combination of achievable eye, head, and body movement. The field of view is restricted by obstructions imposed by the facial structure around the eye and/or placed in front of the eye such as the crewmember's helmet if worn, mullions, structure, and/or other equipment. Achievable movement will vary for different flight phases and operational tasks and depends on any constraints to movement that are extant such as being suited, seated, and/or restrained, and any g loads present. With respect to line-of-sight phenomena such as contamination deposition and pluming, any point outboard of the window that is above the plane of the outer surface of the outermost pane of the window port is considered within the field of view of the window.

Term	Definition
First aid	The level of medical care that provides the capability to treat minor medical conditions and minor trauma. Example “first aid” items are headache medication, nasal decongestant, bandages, and eye drops.
Function Allocation	A function allocation formulates a functional description of a system and allocations of functions among system components (including crew, hardware, and software).
Functional reach envelope	Reach envelope is the volume representing the reach limits of the human body. Functional reach envelope, or work envelope, refers to the volume within which a specific function or task can be performed. The shape and volume of functional reach envelopes depend on the task, motion, and function to be accomplished by the reach action. Limited reach envelope data in standard anthropometrical positions are available in sources of static and dynamic anthropometrical data. Unfortunately, reach data for space applications, like range-of-motion data, is greatly affected by the restricted postures maintained by crewmembers while wearing bulky flight suits and being restrained by straps in sometimes awkward postures. During hypergravity, because of an increase in whole body weight, limb weight, and segment weights, the range of motion for most joints will become restricted. Most importantly, the mobility of the neck, legs, and arms will be severely restricted, reducing the size of functional reach envelopes.
Gravity environments	The range of sustained forces or accelerations from 0g through microgravity, to partial gravity of asteroid, lunar, and planetary surfaces, to the one-gravity of Earth, through the multigravity forces of accelerations in launch and landings and space travel to larger planetary bodies.
Ground support equipment	Nonflight systems, equipment, or devices necessary to support such operations as transportation, receiving, handling, assembly, inspection, test, checkout, servicing, launch, and recovery of space systems.
Habitability	The relationship between an individual and their environment—the resultant of the interplay of all the factors relating to the person, their machine, their environment, and the mission to be accomplished. Privacy concerns become an issue when people are confined to smaller and cramped quarters. Privacy supports focus, concentration, rest, and recuperation.

Term	Definition
Habitat	An environment, not normally mobile, that has the conditions necessary to sustain the lives of the crewmembers and to allow them to perform their functions in an efficient manner.
Hatch	An opening with a sealable cover.
Haze	The fogged appearance of a window or lens that occurs when light rays deviate from the incident beam by forward scattering as they pass through the window, measured as a percentage of the transmitted light that is deviated. Haze is caused by fine surface roughness, contamination, scratches, or internal inhomogeneities and inclusions.
Heat load	Heat being imposed on a system by any means (metabolism, electrical resistance, external environment, etc.). This heat must be removed or otherwise managed to maintain temperature.
Housekeeping	Actions performed by the crew during a mission to maintain a healthy and habitable environment within the spacecraft. Examples of housekeeping activities are biocidal wiping of spacecraft interior surfaces, cleaning or servicing of food preparation or hygiene facilities, and trash management.
Human engineering	Human engineering (also referred to as human factors engineering, human factors, or ergonomics) is the scientific discipline concerned with the understanding of interactions between humans and other elements of a system, and is the profession that applies theory, principles, data, and other methods to design in order to optimize human well-being and overall system performance.
Human factors	Human factors applies knowledge of human abilities and limitations to design of systems, organizations, jobs, machines, tools, and consumer products for safe, efficient, and comfortable human use.
Illuminance	Illuminance is the photometric measure of the density of luminous flux intercepting a surface. Illuminance is expressed in units of lux.
Impact acceleration	A change of velocity over a duration variously defined as less than one-half second to less than two-tenths of a second (< 0.5 to 0.2 sec).
Inclusions	A term used to denote the presence of all localized defects of essentially circular cross section within bulk materials, including bubbles, seeds, striae knots, small stones, sand, and crystals. Inclusions scatter light in proportion to their area. Near an image plane, inclusions can be objectionable because of their visibility in images.

Term	Definition
Index of refraction	The index of refraction or refractive index is a material property. It refers to the ratio of the speed of light in a vacuum to the phase velocity in the material. It is wavelength- and temperature-dependent. The index of refraction of vacuum is 1.0. The index of refraction of air is 1.0003. The index of refraction of fused silica varies from 1.469 to 1.455 across the visible spectrum at 20 °C.
Information management functions	Information management functions include the collection, organization, use, control, dissemination, and disposal of information.
Interpretable	Capable of being explained or told the meaning of, translated into intelligible or familiar language or terms.
Intravehicular activity (IVA)	Operations performed by crewmembers within the pressurized environment of a spacecraft during a mission.
Ionizing radiation	Radiation that wholly or partly converts items with which it collides into ions (electrically charged particles). The particulate radiation component includes all subatomic particles such as protons, neutrons, electrons, atomic nuclei stripped of orbital electrons, and mesons.
Legibility	The extent to which alphanumeric characters and symbols are sufficiently distinct to be easily perceived, deciphered, or recognized.
Linear acceleration	The rate of change of velocity of a mass, the direction of which is kept constant.
Loss of crew	Death of or permanently debilitating injury to one or more crewmembers.
Loss of mission	Loss of or inability to complete significant or primary mission objectives.
Lumen	The lumen is the photometric unit of luminous flux. For light of 555 nm wavelength, luminous flux of 683 lumens in photometric terms is equivalent to 1 watt of light power in radiometric terms.
Luminance	Luminance is the photometric measure most closely associated with the sensation of brightness, and it relates the distribution of luminous intensity over the surface area of a light source or reflector. Luminance is expressed in units of candela per square meter.
Luminous flux	Luminous flux is photometric light power, the flow of light energy over time. Luminous flux is expressed in photometric units of lumens.

Term	Definition
Luminous intensity	Luminous intensity is the photometric measure of luminous flux emitted per unit of solid angle. Luminous intensity is expressed in units of candela.
Lux	The lux is the photometric unit of measure for illuminance. One lux equals a flux distribution of 1 lumen per square meter.
Masked threshold	The level of auditory danger signal that is just audible over the ambient noise, taking into account the acoustic parameters of both the ambient noise in the signal reception area and the listening deficiencies (hearing protection, hearing loss, and other masking effects). The masked threshold is calculated per Annex B of ISO 7731:2003(E).
Medical imaging	The level of medical care that provides the capability to acquire diagnostic-quality external and internal images of the human body with or without remote guidance from terrestrial experts. Examples of “imaging” hardware are digital cameras, ultrasound, and x-ray equipment.
Mission	Expedition into space and/or extraterrestrial stay, intended to accomplish specific scientific and technical objectives.
Mission-critical	An event, system, subsystem, or process that must function properly to prevent loss of mission, launch scrub, or major facility damage.
Monitoring	Includes checking for quality or fidelity, testing to determine whether a signal comes within limits, watching and observing for a specific signal or purpose, keeping track of, regulating, or controlling.
Noise	Undesired sound in the auditory range (15 Hz to 20,000 Hz).
Non-ionizing radiation	Includes three categories of electromagnetic radiation: radio frequency (RF) radiation, lasers, and incoherent electromagnetic radiation.
Open inclusions	Inclusions in bulk material that have become exposed at the surface as a result of polishing or other processing steps. The bottom of an open inclusion is usually more pristine than a dig, which typically is fractured. Therefore, the depth of damage is usually less for an open inclusion than for a dig.
Operation	An activity, mission, or maneuver, including its planning and execution.

Term	Definition
Operator	A crewmember responsible for executing or monitoring an activity or process.
Optical path length (OPL)	Refers to the path that light actually travels within a medium and is described as follows: $OPL = nt$ where n is the index of refraction of the material or medium and t is the physical length of the path. OPL is wavelength-dependent.
Permanent disability	A nonfatal occupational injury or illness resulting in permanent impairment through loss of, or compromised use of, a critical part of the body, including major limbs (e.g., arm, leg), critical sensory organs (e.g., eye), critical life-supporting organs (e.g., heart, lungs, brain), and/or body parts controlling major motor functions (e.g., spine, neck). Therefore, permanent disability includes a nonfatal injury or occupational illness that, in the opinion of competent medical authority, permanently incapacitates a person to the extent that he or she cannot be rehabilitated to achieve gainful employment in their trained occupation and results in a medical discharge from duties or the civilian equivalent.
Personal protective equipment	Hardware or clothing designed to cover or shield the crewmember from hazards, such as extreme temperatures, chemicals, vacuum, radiation, or noise.
Photon	A unit of intensity of light at the retina equal to the illumination received per square millimeter of pupillary area from a surface having a brightness of 1 candle per square meter.
Photometric	The general term photometric refers to lighting concepts and units that incorporate weighting factors associated with human visual response variation over the visible bandwidth.
Potable water	Suitable, safe, or prepared for drinking.
Privacy	Having an acceptable level of control over the extent of sharing oneself (physically, behaviorally, or intellectually) with others. The level of privacy that is acceptable to a person depends on the individual's background and training.
Program	The infrastructure assigned to design, develop, and deploy a spacecraft system such as Constellation or the International Space Station.

Term	Definition
Protective cover	An internal non-pressure-containing, transparent sheet or pane, usually of a material different from the window panes, such as acrylic or other material, intended to protect the underlying window pressure pane and/or protective pane(s) from incidental crew contact. A protective cover is normally not an integral part of the window assembly and has the characteristics specified in Chapter 8.6.6.1.2. Non-integral protective panes can be considered temporary; that is, replaceable after some period of time after which their optical quality has degraded below the category level for which they were designed. External window protection devices are referred to as shutters.
Protective pane	An external or internal non-pressure-containing, transparent pane that is intended to protect the underlying window pressure pane(s) from natural and induced environmental degradation such as contamination, erosion, debris impacts, and incidental crew contact. A protective pane is normally considered an integral part of the window assembly and is at least of the same optical quality as the window pane(s) it protects. Protective panes can be considered temporary; that is, replaceable after some period of time after which their optical quality has degraded below the category level for which they were designed. External protective panes can be considered sacrificial.
Psychomotor	Of or relating to muscular action believed to ensue from conscious mental activity.
Quartz crystal microbalance (QCM)	A device that uses a piezoelectric quartz crystal to detect the presence of contamination. A QCM compares the resonance frequency of a shielded quartz crystal, which remains contamination free, with one that is exposed to the environment and thus to deposition of contamination. Calibrating the QCM makes it possible to determine the amount of mass deposition.
Radiometric	The term radiometric refers to lighting concepts and units that are based in physical quantities without reference to human visual response.

Rayleigh limit	<p>An ideal window would induce no errors into a transmitting wavefront. Wavefront error (optical path difference) in a window degrades the quality of images taken through the window by an optical system. The Rayleigh limit addresses how much wavefront error can be introduced by a window and not affect the image quality of a near-diffraction-limited optical system viewing through it. The Rayleigh limit allows not more than 1/4 wave peak-to-valley optical path difference (OPD), with the reference wavelength typically being 632.8 nm. If the total optical aberrations are limited to less than 1 Rayleigh limit, then systems with smaller apertures (standard cameras, binoculars, etc.) will perform well. When an optical system images a point source (like a star), a diffraction-limited (perfect) system will produce an image of the point source, but because of diffraction, the image will have a central bright disc and a series of concentric rings surrounding the central disk (called an Airy disc). In a perfect system, 84% of the energy will be located in the central disk, and 16% of the energy in the surrounding rings. As the wavefront error is increased, a shift of energy from the central disc to the rings becomes noticeable. This energy shift makes the image start looking blurry. For small amounts of wavefront error, the energy distribution is as follows:</p> <table border="1" data-bbox="537 1031 1338 1314"> <thead> <tr> <th>Wavefront Error ($\lambda = 632.8 \text{ nm}$)</th> <th>Energy in Central Disk</th> <th>Energy in Rings</th> </tr> </thead> <tbody> <tr> <td>Perfect Lens (OPD = 0)</td> <td>0.84</td> <td>0.16</td> </tr> <tr> <td>OPD = $\lambda/16$</td> <td>0.83</td> <td>0.17</td> </tr> <tr> <td>OPD = $\lambda/8$</td> <td>0.8</td> <td>0.2</td> </tr> <tr> <td>OPD = $\lambda/4$ [1 Rayleigh limit]</td> <td>0.68</td> <td>0.32</td> </tr> </tbody> </table> <p>It is apparent that the amount of aberration corresponding to 1 Rayleigh limit does cause a small but appreciable change in the characteristics of the image. However, for most small-aperture systems, particularly cameras, the performance is more than acceptable. For larger aperture systems, such as telescopes and other high-performance systems, the Rayleigh limit is not sufficient to ensure that noticeable degradation is not introduced by the window. Therefore, Category A windows require an OPD of no more than 1/10 wave.</p>	Wavefront Error ($\lambda = 632.8 \text{ nm}$)	Energy in Central Disk	Energy in Rings	Perfect Lens (OPD = 0)	0.84	0.16	OPD = $\lambda/16$	0.83	0.17	OPD = $\lambda/8$	0.8	0.2	OPD = $\lambda/4$ [1 Rayleigh limit]	0.68	0.32
Wavefront Error ($\lambda = 632.8 \text{ nm}$)	Energy in Central Disk	Energy in Rings														
Perfect Lens (OPD = 0)	0.84	0.16														
OPD = $\lambda/16$	0.83	0.17														
OPD = $\lambda/8$	0.8	0.2														
OPD = $\lambda/4$ [1 Rayleigh limit]	0.68	0.32														
Reflectance	The fraction or percentage of incident light or other type of wave at a specified wavelength that is reflected from a surface (also see specular and diffuse reflectance).															
Rotational acceleration	The rate of change of direction of mass during angular motion.															

Safe	Conditions absent of hazards. Having a low risk of loss of life, serious injury, or permanent disability to personnel, or a low risk of loss or damage to spacecraft or mission.
Scratches	Any markings or tearing of the native surface material, substrate, surface coating, or surface laminate along the line of the surface, appearing as though caused by the movement of a rough or a hard, sharp object that leaves a roughened depression.
Seeds	A term used to denote a gaseous inclusion having an extremely small diameter in glass.
Sensory	Pertaining to the information-gathering abilities of humans to see, hear, touch, smell, and taste. Includes temperature, pain, kinesthesia, and equilibrium.
Spacecraft	A mobile or static environment with a pressurized atmosphere appropriate for sustained unsuited survival and crew operations. It can be a habitat (defined above) or a container, which is generally composed of multiple elements, used to transport persons or things to and/or from a location outside of the Earth's atmosphere. A spacecraft includes all hardware and equipment within or attached to the pressurized environment.
Specular reflection	The perfect, mirror-like reflection of a wave such as light from a surface, in which the light from a single incoming direction is reflected into a single outgoing direction as described by Snell's Law ($\theta_i = \theta_r$). Diffuse reflection, on the other hand, refers to light that is reflected in a broad range of directions (see diffuse reflectance). The most familiar example of the distinction between specular and diffuse reflection in the case of light waves would be glossy and matte paints or photo prints. Although both finishes exhibit a combination of specular and diffuse reflectance, glossy paints and photo prints have a greater proportion of specular reflectance and matte paints and photo prints have a greater proportion of diffuse reflectance. Antireflective coatings reduce the amount of light that is reflected from a given surface. Reflectance for an uncoated glass surface is ~4%, which yields ~8% for the two surfaces of a single pane. Antireflective coatings can reduce the total reflectance to ~2% or less.
Stakeholder	An individual or organization having an interest (or stake) in the outcome or deliverable of a program or project.

Standard	<p>The definition of a “standard” is described as follows:</p> <p>a. The term “standard,” or “technical standard,” includes all of the following: (1) Common and repeated use of rules, conditions, guidelines or characteristics for products or related processes and production methods, and related management systems practices. (2) The definition of terms; classification of components; delineation of procedures; specification of dimensions, materials, performance, designs, or operations; measurement of quality and quantity in describing materials, processes, products, systems, services, or practices; test methods and sampling procedures; or descriptions of fit and measurements of size or strength.</p> <p>b. “Performance standard” is a standard as defined above that states requirements in terms of required results with criteria for verifying compliance but without stating the methods for achieving required results. A performance standard may define the functional requirements for the item, operational requirements, and/or interface and interchangeability characteristics. A performance standard may be viewed in juxtaposition to a prescriptive standard, which may specify design requirements, such as materials to be used, how a requirement is to be achieved, or how an item is to be fabricated or constructed.</p> <p>c. “Non-government standard” is a standard as defined above that is in the form of a standardization document developed by a private sector association, organization, or technical society that plans, develops, establishes, or coordinates standards, specifications, handbooks, or related documents.</p>
Striae	<p>Spatially short range variations (0.1 mm to 2 mm) in the index of refraction of a transparent material, usually of glass, especially when it is formed into panes. Striae are different from spatially global index of refraction inhomogeneities that affect the complete material piece. Striae induce wavefront errors.</p>
Suited	<p>Wearing clothing that is designed to protect the crewmember from differences in aspects of the environment such as pressure, atmosphere, gravity, or temperature. Suited can refer to a pressurized or unpressurized suit.</p>
Surgical care	<p>The level of medical care that provides the capability to treat internal medical conditions resulting from illness or injury that require intervention beyond pharmaceuticals. Local, regional, or systemic anesthesia may be required for successful administration of care. Examples of “surgical care” hardware are surgical instruments, endoscopic equipment, and high-intensity focused ultrasound.</p>

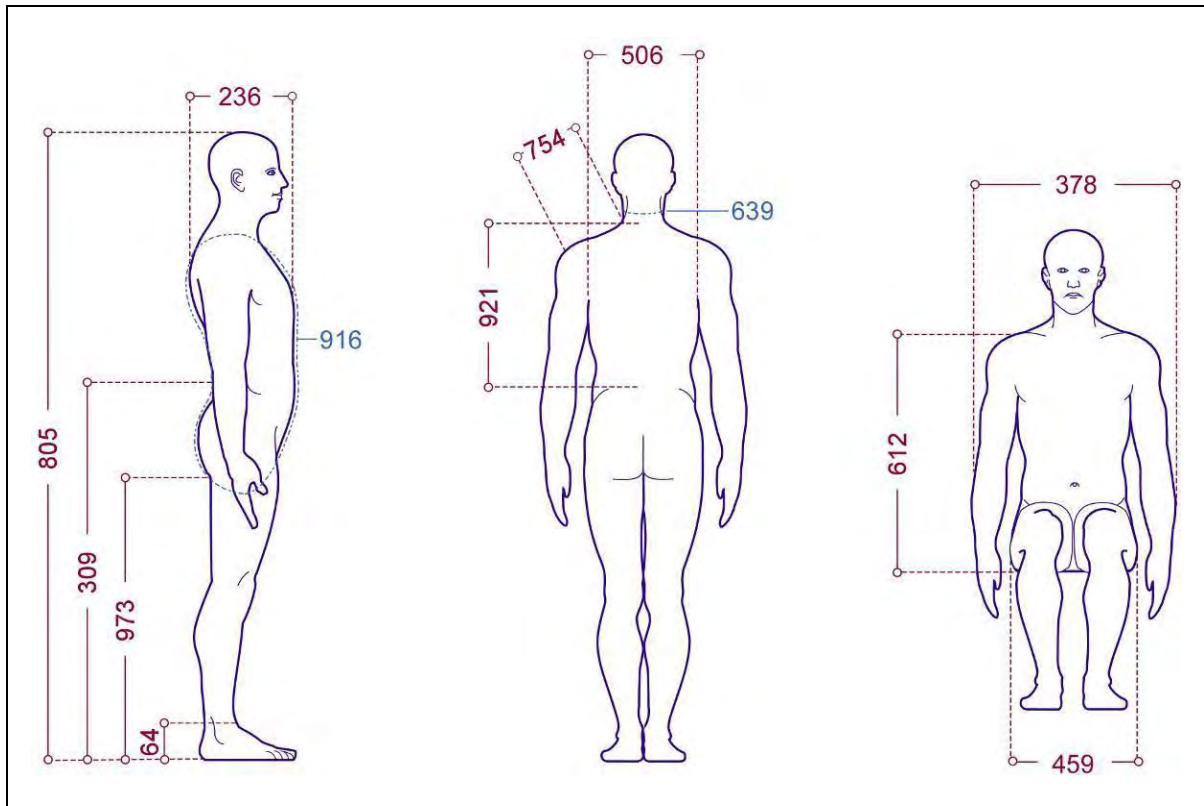
Sustained acceleration	An acceleration event, linear or rotational, with duration greater than 0.5 second. For sustained acceleration events during which acceleration peaks more than once and dwells at a lower acceleration between, the following rule is used to determine if the event is considered to be one combined event or two separate events. For each acceleration level, if the duration between two sustained events is longer than the duration of the first event, then the event is considered two separate events. If the duration between the two events is less than or equal to the duration of the first acceleration event, they are considered one event. This rule is to be used for each axis in the event separately.
System	The combination of elements that function together to produce the capability to meet a need. The elements include all hardware, software, equipment, facilities, personnel, processes, and procedures needed for this purpose.
Task	A specific piece or amount of work. A subset of an activity or job that is called out in a procedure.
Task analysis	Task analysis is an activity that breaks a task down into its component levels. It involves 1) the identification of the tasks and subtasks involved in a process or system and 2) analysis of those tasks (e.g., who performs them, what equipment is used, under what conditions, the priority of the task, dependence on other tasks). The focus is on the humans and how they perform the task, rather than on the system. Results can help determine the displays or controls that should be developed or used for a particular task, the ideal allocation of tasks to humans vs. automation, and the criticality of tasks, which will help drive design decisions.
Telemedicine	The level of medical care that provides the capability for real-time or store-and-forward consultation with a flight surgeon and/or medical consultants for the purpose of enhancing the quality of medical diagnosis and treating an ill or injured crewmember.
Transient acceleration	An acceleration event, linear or rotational, with a duration of less than or equal to 0.5 second.
Transmittance	The fraction or percentage of incident light at a specified wavelength that passes through a medium.
Trauma care	The level of medical care that provides the capability to stabilize a crewmember injured by blunt or penetrating trauma. Examples of “trauma care” hardware are suturing capability, parenteral antibiotics, splints, chest tube and closed drainage, and intravenous fluids.

Unimpeded access	Access that allows something to be immediately visible and accessible without being blocked or constrained by other equipment. Unimpeded access is important for emergency systems and other critical items.
Unsuited	Wearing the type of clothing that is ordinarily worn inside a spacecraft.
Visual annunciation	A visual, computer-generated text- or graphics-based signal. Examples are warning messages and flashing icons.
Wavefront	Light travels as an electromagnetic wave. A wavefront is defined as a surface joining all adjacent points on a wave that have the same phase.
Wavefront error	The total optical path difference induced into a wavefront with respect to the wavelength of light, usually referenced to a HeNe laser wavelength of 632.8 nm. For planar waves, wavefront error occurs when the wavefront is distorted so that an individual wavefront is no longer in phase. This occurs when different parts of the wavefront travel different optical path lengths. In an ideal window, a planar wave will pass through it so that the optical path length at each point on the window is the same, and the wavefront retains the same phase. Wavefront error is aperture dependent. In an imperfect window, the wavefront is distorted; that is, the phase is not maintained. Wavefront error can be distorted by surface imperfections (the window is not “flat”) or by material inhomogeneities (the index of refraction varies across the window).
Wedge	The angle formed by and between the two surfaces of an individual window pane.
Window	The same as and used interchangeably with window port.
Window cover	See “Protective cover.”
Window filter	An internal, non-pressure-containing, transparent sheet or pane, usually of a material different from the window panes, such as polycarbonate or other material, intended to filter non-ionizing radiation hazards to safe levels. A window filter is not considered an integral part of the window assembly. Window filters are easily removed and reinstalled by one crewmember without the use of tools. A window filter may also serve as a protective cover.

Window port	The finished assembly including the frame structure (includes all gaskets, bolts, spacers, and other such parts) and all window panes that would normally be used at a specific location with any protective panes, permanent coatings, polycarbonate films, or laminates applied or in place.
Window shade	Usually an internal, non-pressure-containing, opaque sheet intended to block external light from entering the interior of a crew cabin. A window shade may or may not be an integral part of the window assembly. Non-integral window shades are easily removed and reinstalled by one crewmember without the use of tools. Window shades that are an integral part of the window assembly can also act as window shutters.
Window shutter	An internally and remotely operable external cover intended to prevent natural and induced environmental degradation (e.g., contamination, erosion, and impacts) of the outboardmost window pane with open and close indicators that are readable from the remote operating location. Window shutters can be operated through their full range of motion in less than 10 seconds and can serve as window shades.
Workload	The amount of work expected in a unit of time. Physical workload refers to the number of individual physical activities that are conducted simultaneously or in close succession. Similarly, mental or cognitive workload refers to the number of mental operations or activities that are conducted simultaneously or in close succession.
Workstation	A place designed for a specific task or activity, from which work is conducted or operations are directed. Workstations include cockpits, robotics control stations, and other work areas that have work surfaces, tools, equipment, or computers.
Zero gravity (0g)	For the purposes of this document, 0g is used as a synonym for microgravity.

APPENDIX B – Example Data for Anthropometry, Biomechanics and Strength

Table 1a Anthropometric Dimensional Data for American Female and Male

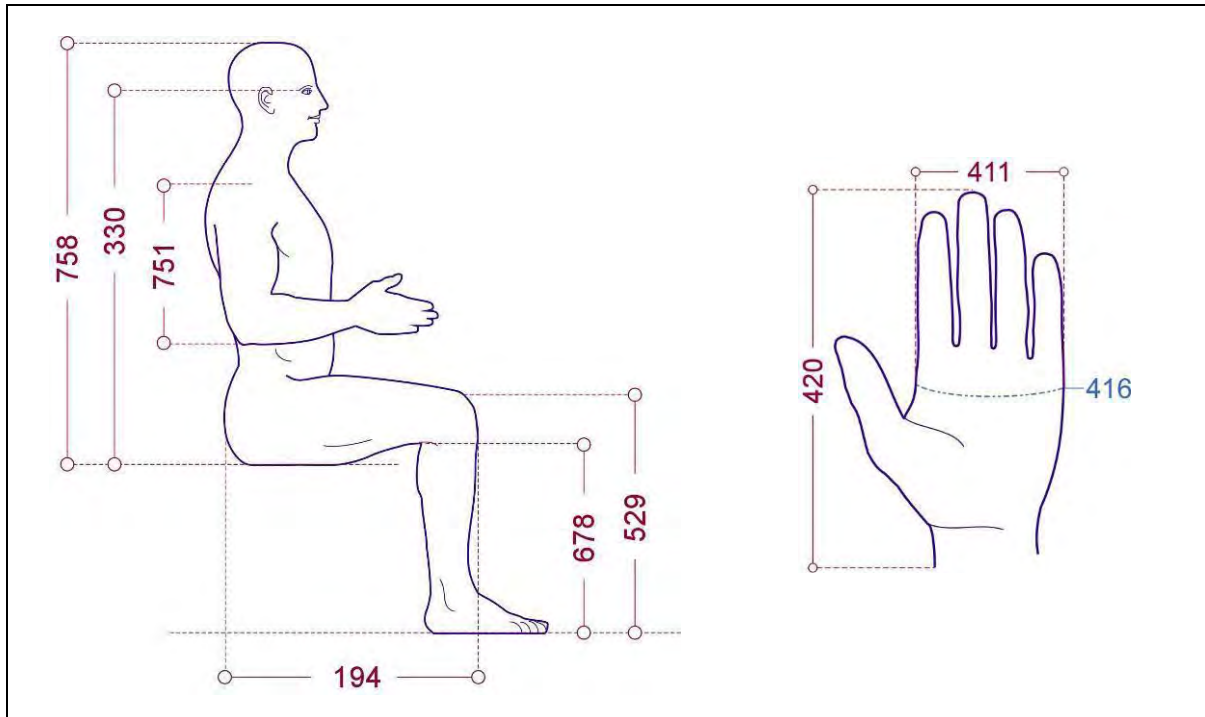


No.	Dimension	Min (cm, (in))	Max (cm, (in))
805	Stature	148.6 (58.5)	194.6 (76.6)
973	Wrist height	70.3 (27.7)	96.3 (37.9)
64	Ankle height	4.8(1.9)	8.1 (3.2)
309	Elbow height (rest height standing)	89.9 (35.4)	120.7 (47.5)
236	Bust depth (chest depth)	19.1 (7.5)	30.2 (11.9)
916	Vertical trunk circumference	134.9 (53.1)	181.9 (71.6)
612	Mid-shoulder height, sitting	52.6 (20.7)	71.1 (28.0)
459*	Hip breadth, sitting	31.5 (12.4)	46.5 (18.3)
921	Waist back	39.1 (15.4)	55.9 (22.0)
506	Interscye	29.3 (11.5)	48.0 (18.9)
639	Neck circumference	27.8 (10.9)	43.4 (17.1)
754	Shoulder length (side neck-to-acromion horizontal distance)	12.0 (4.7)	18.0 (7.1)
378	Forearm-forearm breadth	38.9 (15.3)	66.0 (26.0)

*For seated measurements, the largest female hip breadth is larger than the largest male hip breadth and the smallest male hip breadth is smaller than the smallest female hip

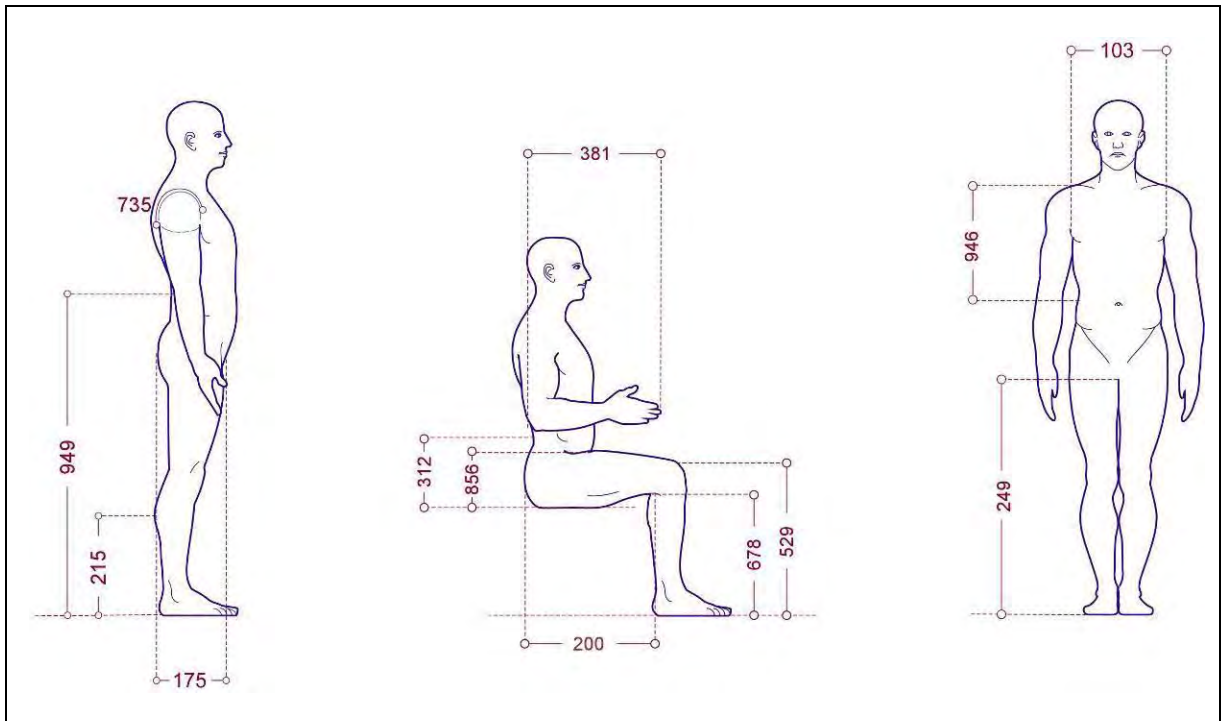
breadth; therefore, male data is used for the Min dimension and female data is used for the Max dimension.

Table 1b Anthropometric Dimensional Data for American Female and Male



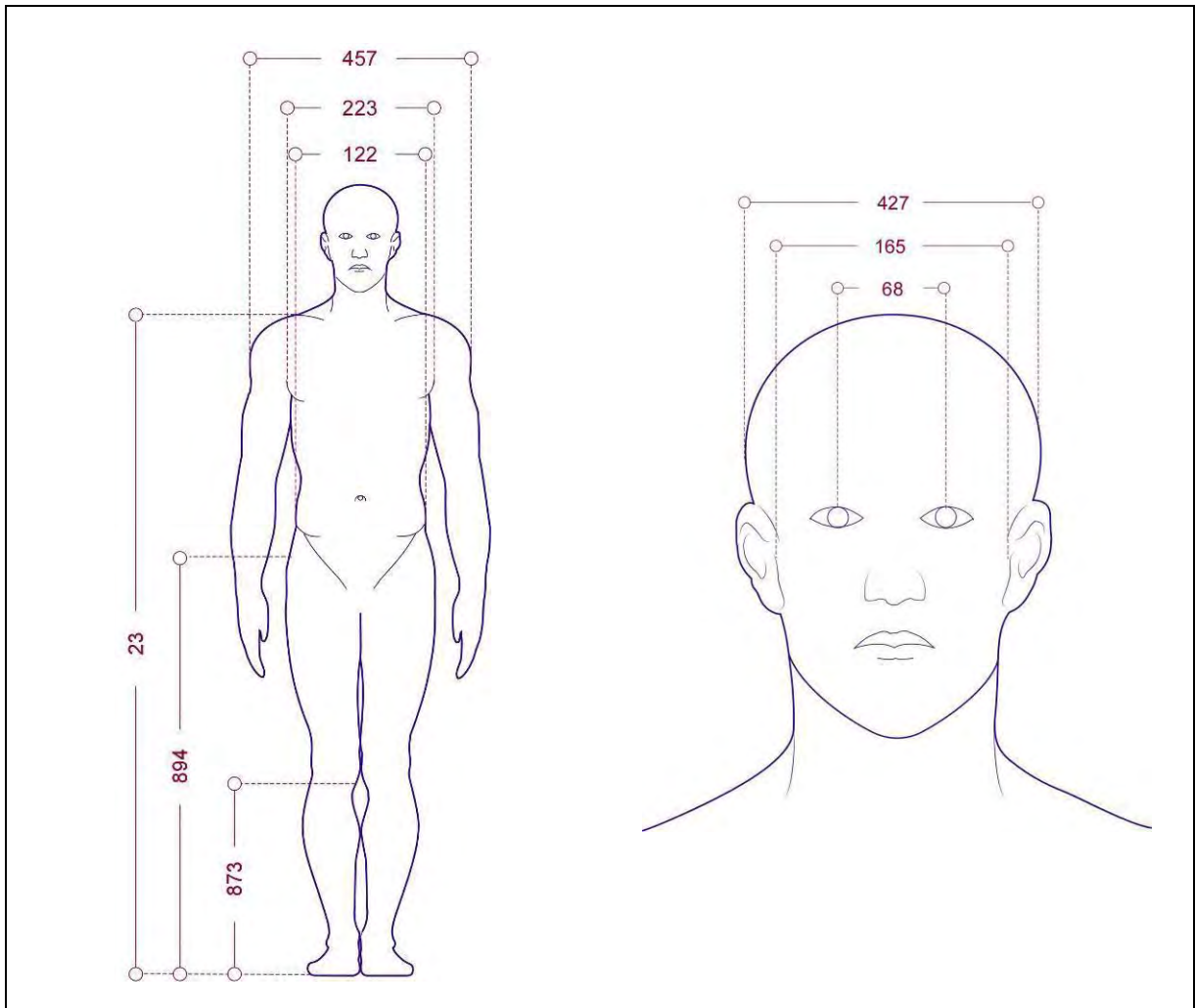
No.	Dimension	Min (cm, (in))	Max (cm, (in))
758	Sitting height	77.7 (30.6)	101.3 (39.9)
330	Eye height, sitting	66.5 (26.2)	88.9 (35.0)
529	Knee height, sitting	45.5 (17.9)	63.5 (25.0)
678	Popliteal height	33.0 (13.0)	50.0 (19.7)
751	Shoulder-elbow length	29.6 (11.6)	41.9 (16.5)
194	Buttock-knee length	52.1 (20.5)	69.9 (27.5)
420	Hand length	15.8 (6.2)	22.1 (8.7)
411	Hand breadth	7.1 (2.8)	10.2 (4.0)
416	Hand circumference	16.8 (6.6)	24.1 (9.5)

Table 1c Anthropometric Dimensional Data for American Female and Male



No.	Dimension	Min (cm, (in))	Max (cm, (in))
949	Waist height	86.6 (34.1)	119.6 (47.1)
249	Crotch height	66.5 (26.2)	95.8 (37.7)
215	Calf height	25.9 (10.2)	41.4 (16.3)
103	Biacromial breadth	32.3 (12.7)	44.5 (17.5)
946	Waist front	34.1 (13.4)	48.8 (19.2)
735	Scye circumference	31.9 (12.6)	52.1 (20.5)
178	Buttock circumference	84.1 (33.1)	114.8 (45.2)
312	Elbow rest height	16.2 (6.4)	30.0 (11.8)
856	Thigh clearance	13.0 (5.1)	20.1 (7.9)
381	Forearm hand length	38.7 (15.2)	54.6 (21.5)
200	Buttock-popliteal length	42.2 (16.6)	57.2 (22.5)

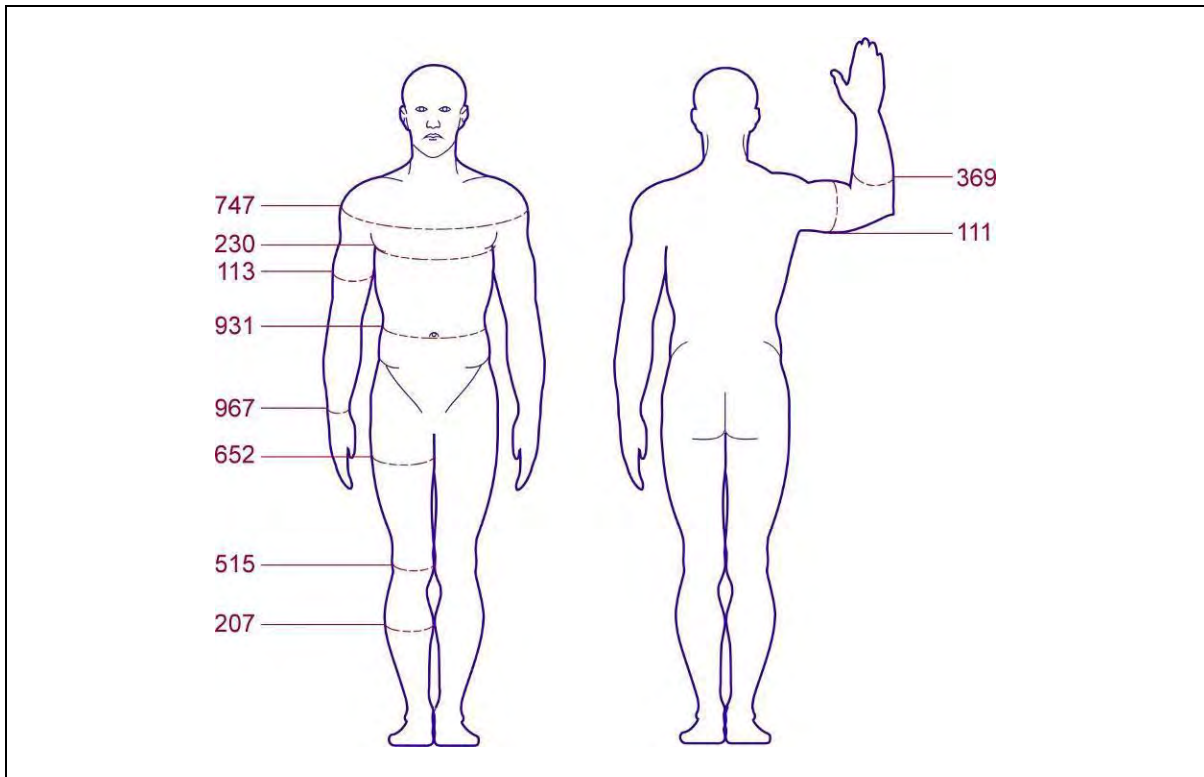
Table 1d Anthropometric Dimensional Data for American Female and Male



No.	Dimension	Min (cm, (in))	Max (cm, (in))
23	Acromial (shoulder) height	120.4 (47.4)	161.8 (63.7)
894	Trochanteric height	75.2 (29.6)	105.4 (41.5)
873	Knee Height, Midpatella	39.6 (15.6)	57.9 (22.8)
122	Bideltoid (shoulder) breadth	37.8 (14.9)	56.1 (22.1)
223	Chest breadth	23.5 (9.3)	39.4 (15.5)
457*	Hip breadth	29.8 (11.7)	40.6 (16.0)
165	Bizgomatic (face) breadth	12.0 (4.7)	15.5 (6.1)
427	Head breadth	13.3 (5.2)	16.5 (6.5)
68	Interpupillary Breadth	5.3 (2.1)	7.4 (2.9)

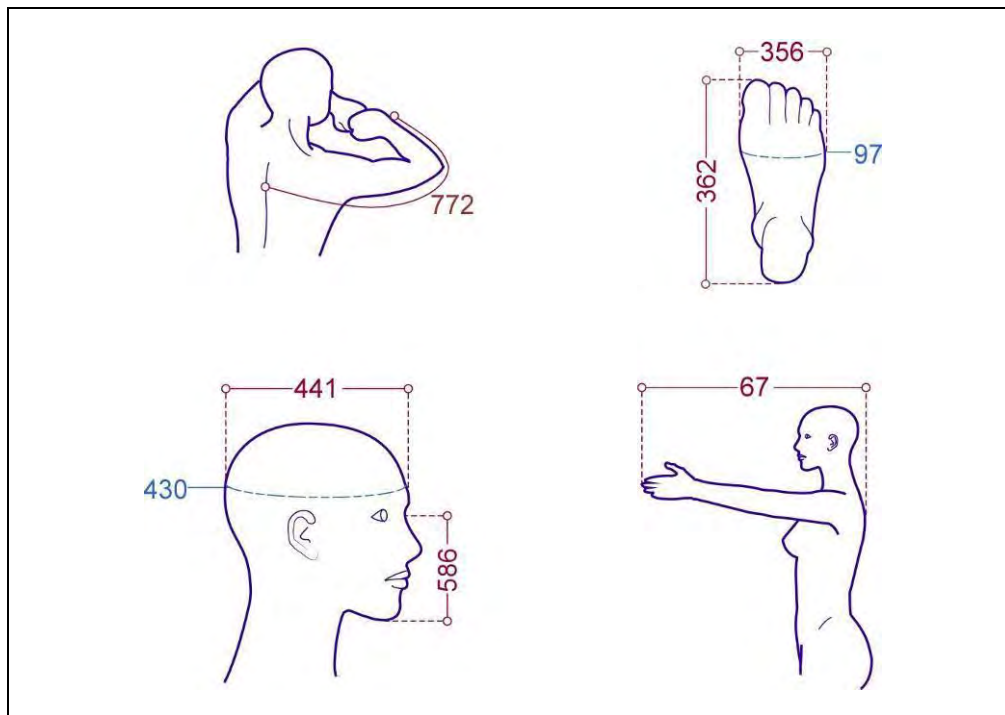
*For standing measurements, the largest female hip breadth is larger than the largest male hip breadth; therefore, female data is used for both the Min dimension and the Max dimension.

Table 1e Anthropometric Dimensional Data for American Female and Male



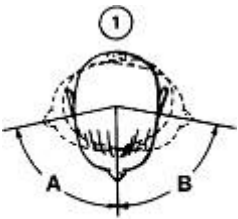
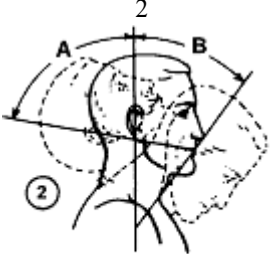
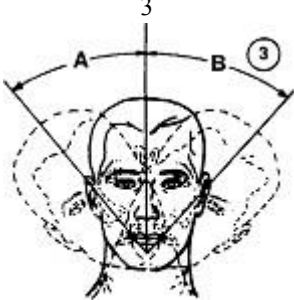
No.	Dimension	Min (cm, (in))	Max (cm, (in))
747	Shoulder circumference	90.4 (35.6)	133.9 (52.7)
230	Chest circumference	75.7 (29.8)	118.6 (46.7)
931	Waist circumference	61.2 (24.1)	110.5 (43.5)
852	Thigh circumference	47.8 (18.8)	71.9 (28.3)
515	Knee circumference	30.7 (12.1)	44.5 (17.5)
207	Calf circumference	29.5 (11.6)	44.5 (17.5)
967	Wrist circumference	13.5 (5.3)	19.8 (7.8)
111	Biceps circumference, flexed	22.9 (9.0)	40.4 (15.9)
369	Forearm circumference, flexed	21.6 (8.5)	35.3 (13.9)

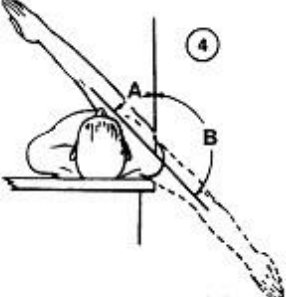
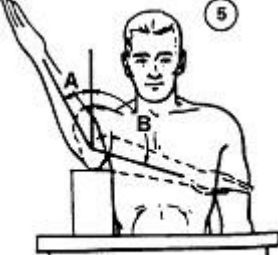
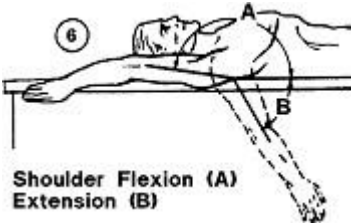

Table 1f Anthropometric Dimensional Data for American Female and Male

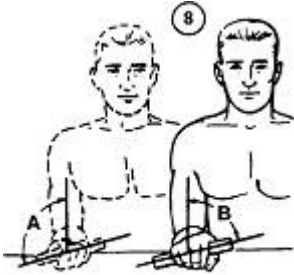
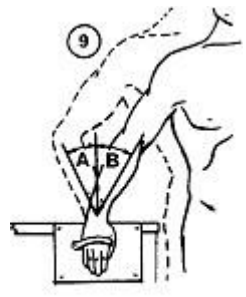
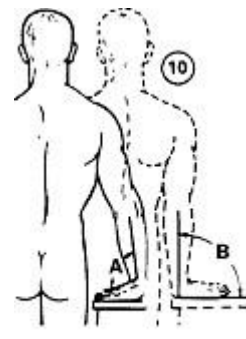
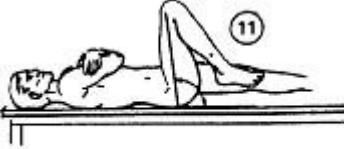


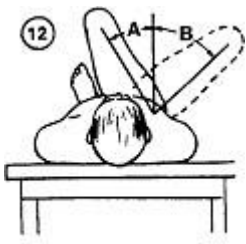
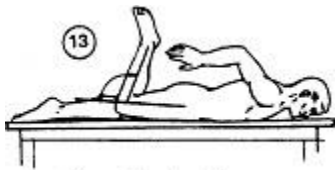

No.	Dimension	Min (cm, (in))	Max (cm, (in))
67	Thumb-tip reach	65.0 (25.6)	90.9 (35.8)
772	Sleeve length	72.4 (28.5)	99.1 (39.0)
441	Head length	17.3 (6.8)	21.6 (8.5)
430	Head circumference	51.3 (20.2)	61.0 (24.0)
586	Menton-sellion (face) length	9.9 (3.9)	14.0 (5.5)
362	Foot length	21.6 (8.5)	30.5 (12.0)
356	Foot breadth	7.9 (3.1)	11.4 (4.5)
97	Ball of foot circumference	19.6 (7.7)	28.2 (11.1)

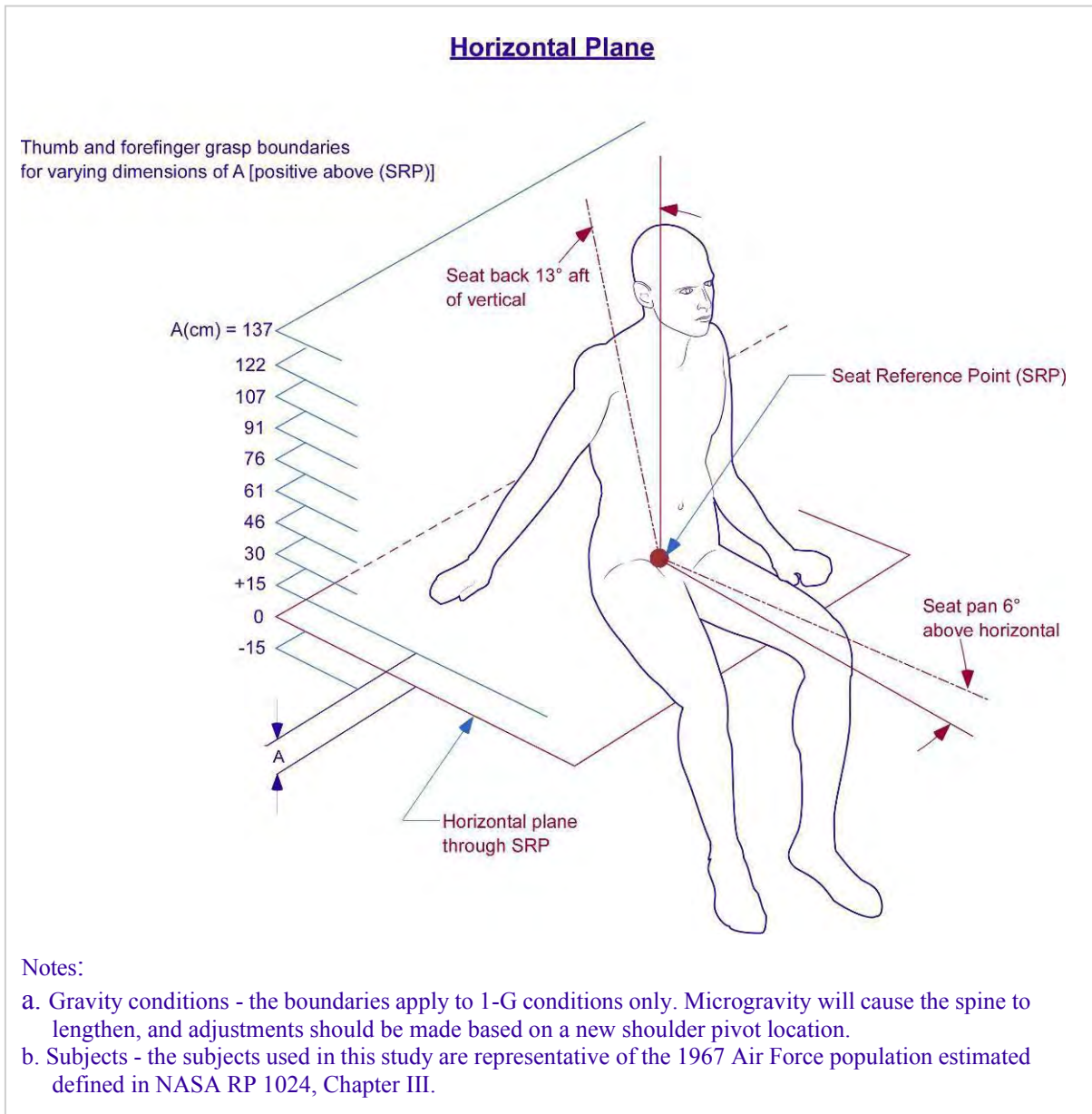
Table 2 Joint Movement Ranges for Males and Females

Figure	Joint movement (note b)	Range of motion (degrees) (note a)
<p style="text-align: center;">1</p>  <p style="text-align: center;">Neck Rotation Right (A) Left (B)</p>	<p>Neck, rotation right (A)</p> <p>Neck, rotation left (B)</p>	<p style="text-align: center;">73</p> <p style="text-align: center;">72</p>
<p style="text-align: center;">2</p>  <p style="text-align: center;">Neck Extension [A] Flexion (B)</p>	<p>Neck, extension (A)</p> <p>Neck, flexion (B)</p>	<p style="text-align: center;">34</p> <p style="text-align: center;">65</p>
<p style="text-align: center;">3</p>  <p style="text-align: center;">Neck Lateral Bend Right (A) Left (B)</p>	<p>Neck, lateral bend right (A)</p> <p>Neck, lateral bend left (B)</p>	<p style="text-align: center;">35</p> <p style="text-align: center;">29</p>

<p style="text-align: center;">4</p>  <p>Horizontal Adduction (A) Horizontal Abduction (B)</p>	<p>Shoulder, abduction (B)559</p> <p>Shoulder, adduction (A)559</p>	<p style="text-align: right;">135*</p> <p style="text-align: right;">45*</p>
<p style="text-align: center;">5</p>  <p>Shoulder Rotation Lateral (A) Medial (B)</p>	<p>Shoulder, rotation lateral (A)</p> <p>Shoulder, rotation medial (B)</p>	<p style="text-align: right;">46</p> <p style="text-align: right;">91</p>
<p style="text-align: center;">6</p>  <p>Shoulder Flexion (A) Extension (B)</p>	<p>Shoulder, flexion (A)</p> <p>Shoulder, extension (B)</p>	<p style="text-align: right;">152</p> <p style="text-align: right;">33</p>
<p style="text-align: center;">7</p>  <p>Elbow Flexion (A)</p>	<p>Elbow, Flexion (A)</p>	<p style="text-align: right;">141</p>

<p style="text-align: center;">8</p>  <p style="text-align: center;">Forearm Supination (A) Pronation (B)</p>	<p>Forearm, supination (A)</p> <p>Forearm, pronation (B)</p>	<p style="text-align: center;">83</p> <p style="text-align: center;">78</p>
<p style="text-align: center;">9</p>  <p style="text-align: center;">Wrist Ulnar Bend (A) Radial Bend (B)</p>	<p>Wrist, ulnar bend (A)</p> <p>Wrist, radial bend (B)</p>	<p style="text-align: center;">19</p> <p style="text-align: center;">16</p>
<p style="text-align: center;">10</p>  <p style="text-align: center;">Wrist Flexion (A) Extension (B)</p>	<p>Wrist, flexion (A)</p> <p>Wrist, extension (B)</p>	<p style="text-align: center;">62</p> <p style="text-align: center;">40</p>
<p style="text-align: center;">11</p>  <p style="text-align: center;">Hip Flexion</p>	<p>Hip, flexion</p>	<p style="text-align: center;">117</p>

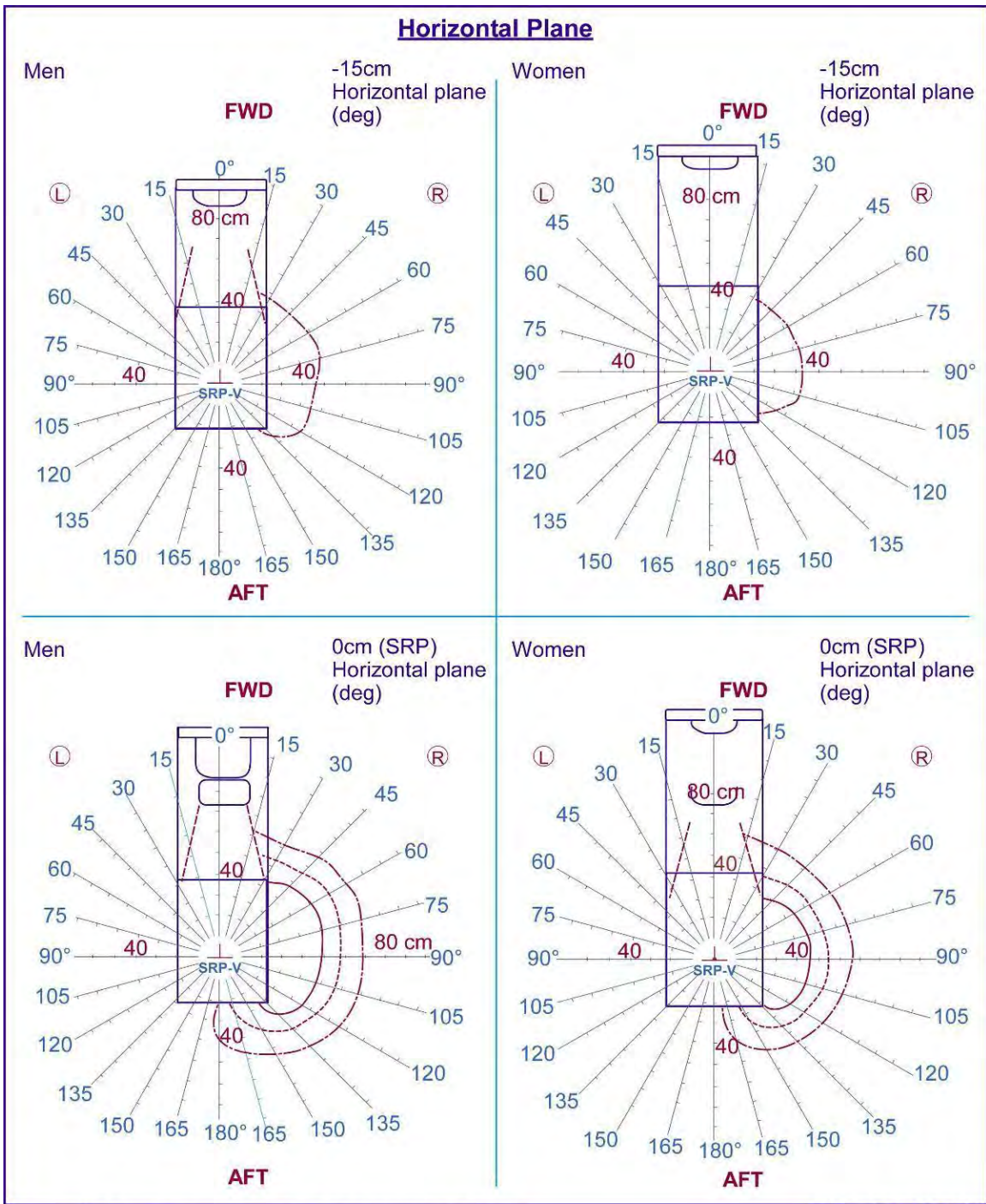
<p style="text-align: center;">12</p>  <p style="text-align: center;">Hip Adduction (A) Abduction (B)</p>	<p>Hip, adduction (A)</p> <p>Hip, abduction (B)</p>	<p style="text-align: center;">30</p> <p style="text-align: center;">35</p>
<p style="text-align: center;">13</p>  <p style="text-align: center;">Knee Flexion, Prone</p>	<p>Knee, flexion</p>	<p style="text-align: center;">118</p>
<p style="text-align: center;">14</p>  <p style="text-align: center;">Ankle Plantar Extension (A) Dorsi Flexion (B)</p>	<p>Ankle, plantar extension (A)</p> <p>Ankle, dorsi flexion (B)</p>	<p style="text-align: center;">36</p> <p style="text-align: center;">7</p>
<p>* Indicates data was missing or unclear and substituted with range of motion calculations from Thompson, 2001.</p> <p>Notes:</p> <p>a. Data was taken during 1979 and 1980 at NASA-JSC by Dr. William Thornton and John Jackson. The study was performed using 192 male (mean age 33) and 22 female (mean age 30) astronaut candidates.</p> <p>b. Limb range is average of right and left limb movement.</p>		



NASA-STD-3000 288a

Figure 3a

Grasp Reach Limits with Right Hand for American Male and Female Populations (1 of 19)



— 5th percentile outer boundary and inner boundary (inner curve)
 - - - 50th percentile outer boundary
 - - - 95th percentile outer boundary

NASA-STD-3000 288b

Figure 3a Grasp Reach Limits with Right Hand for American Male and Female Populations (2 of 19)

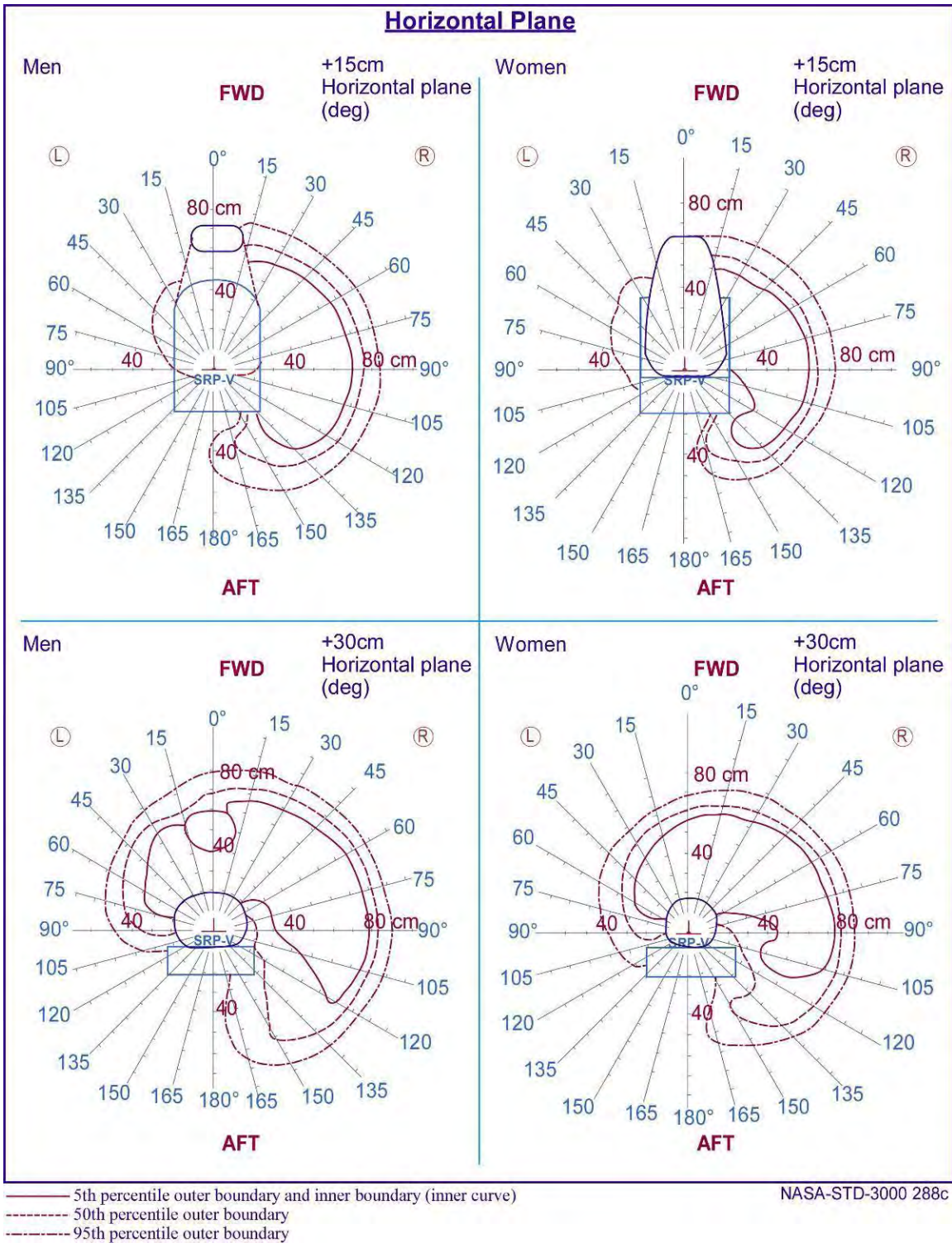


Figure 3a

Grasp Reach Limits with Right Hand for American Male and Female Populations (3 of 19)

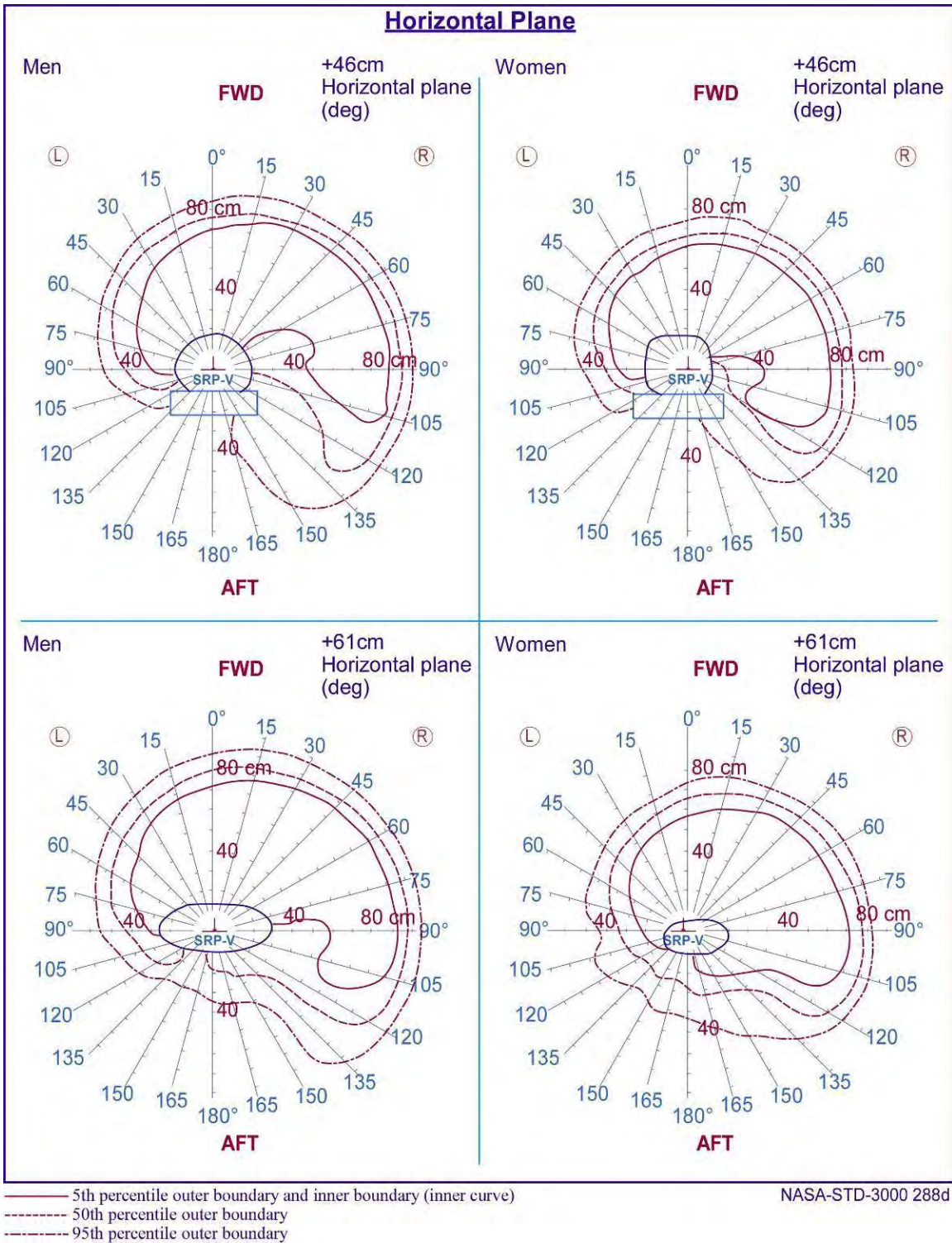
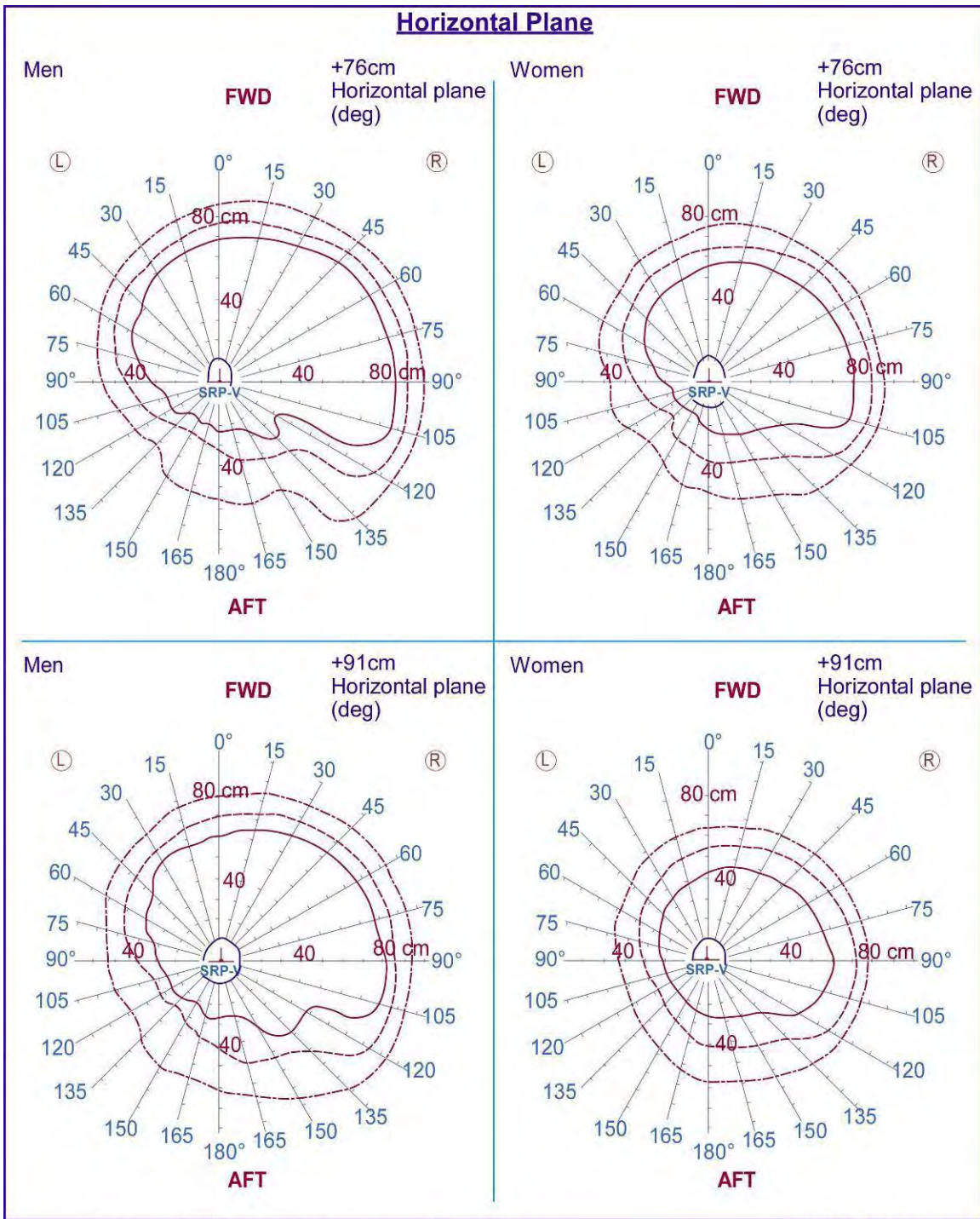


Figure 3a

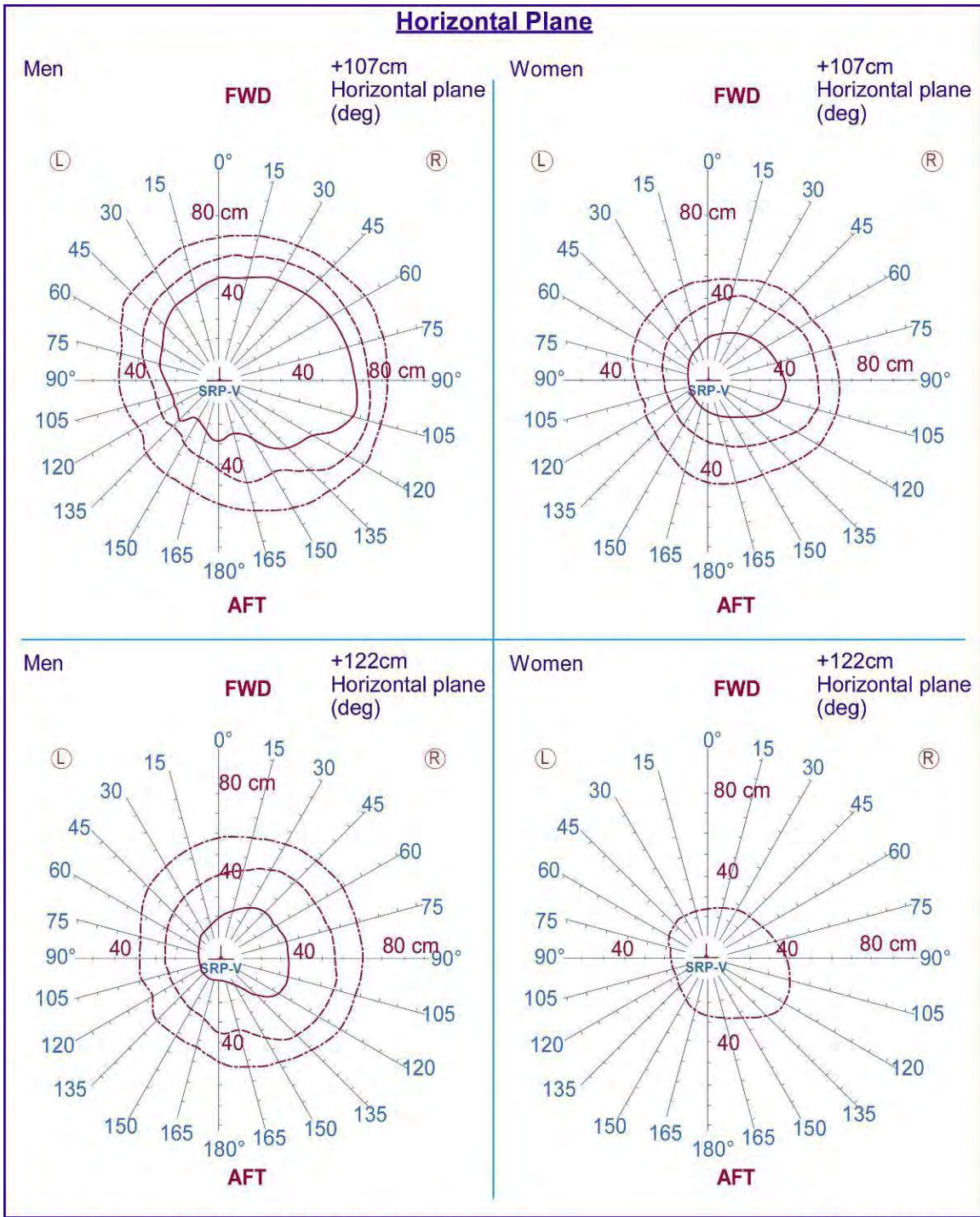
Grasp Reach Limits with Right Hand for American Male and Female Populations (4 of 19)



— 5th percentile outer boundary and inner boundary (inner curve)
 - - - 50th percentile outer boundary
 ···· 95th percentile outer boundary

NASA-STD-3000 288e

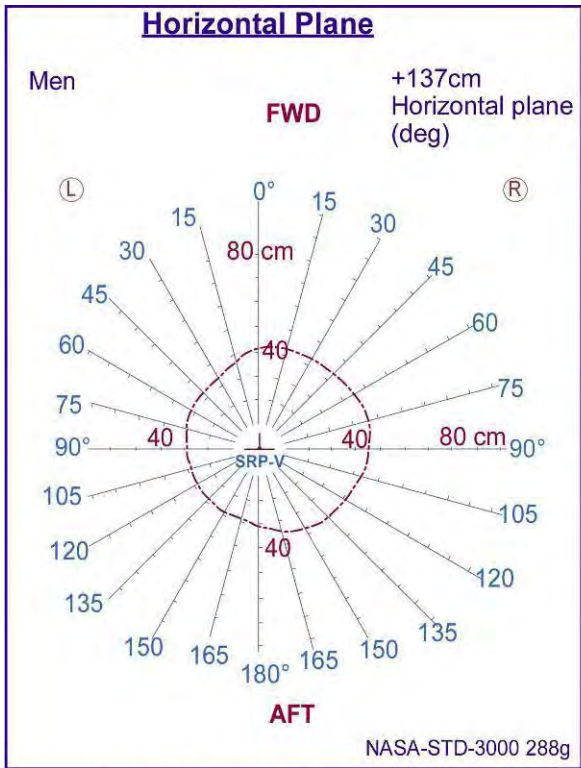
Figure 3a Grasp Reach Limits with Right Hand for American Male and Female Populations (5 of 19)



——— 5th percentile outer boundary and inner boundary (inner curve)
 - - - - - 50th percentile outer boundary
 - · - · - 95th percentile outer boundary

NASA-STD-3000 288f

Figure 3a Grasp Reach Limits with Right Hand for American Male and Female Populations (6 of 19)



- 5th percentile outer boundary and inner boundary (inner curve)
- - - 50th percentile outer boundary
- · - · 95th percentile outer boundary

Figure 3a **Grasp Reach Limits with Right Hand for American Male and Female Populations (7 of 19)**

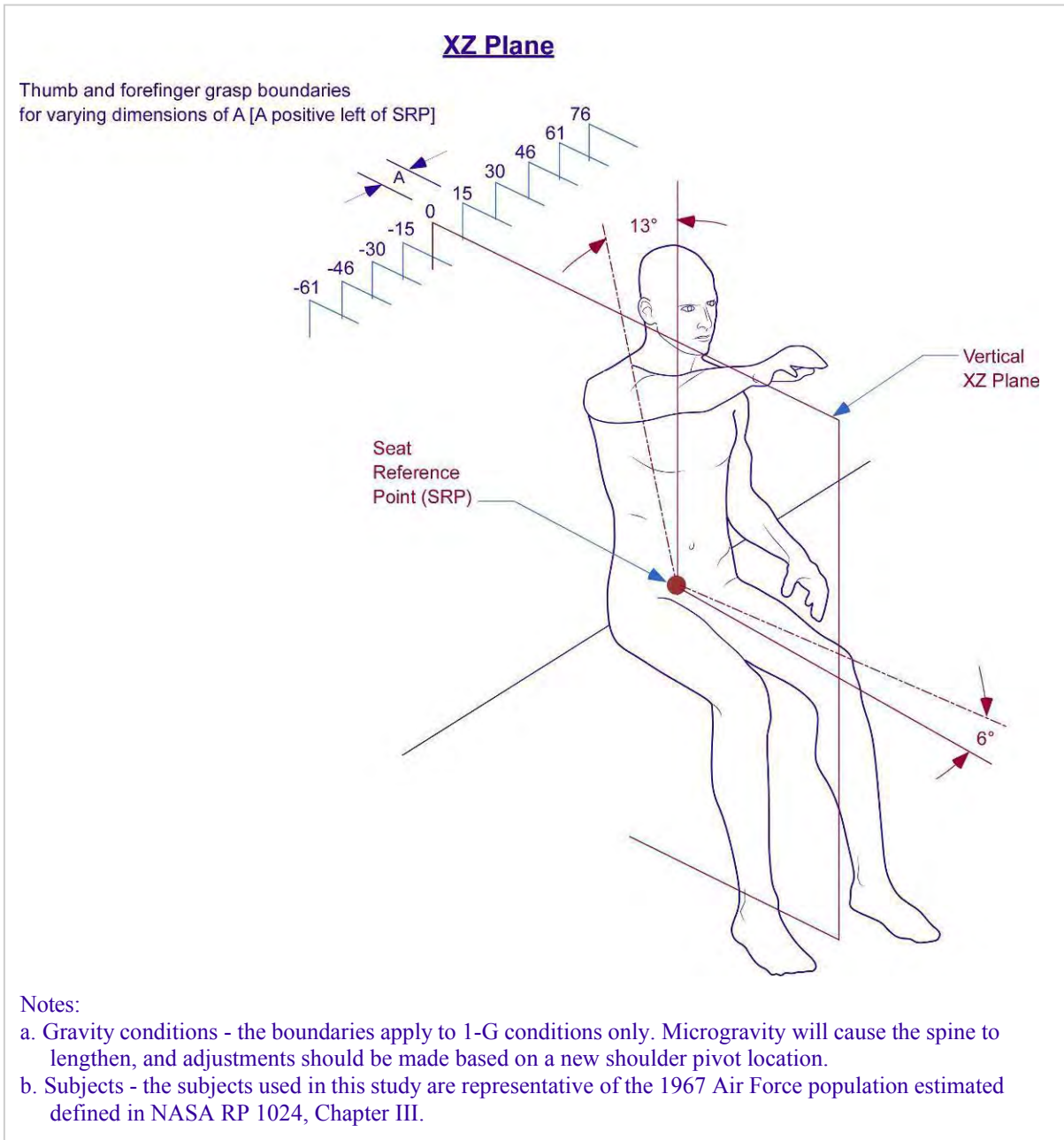


Figure 3b

Grasp Reach Limits with Right Hand for American Male and Female Populations (8 of 19)

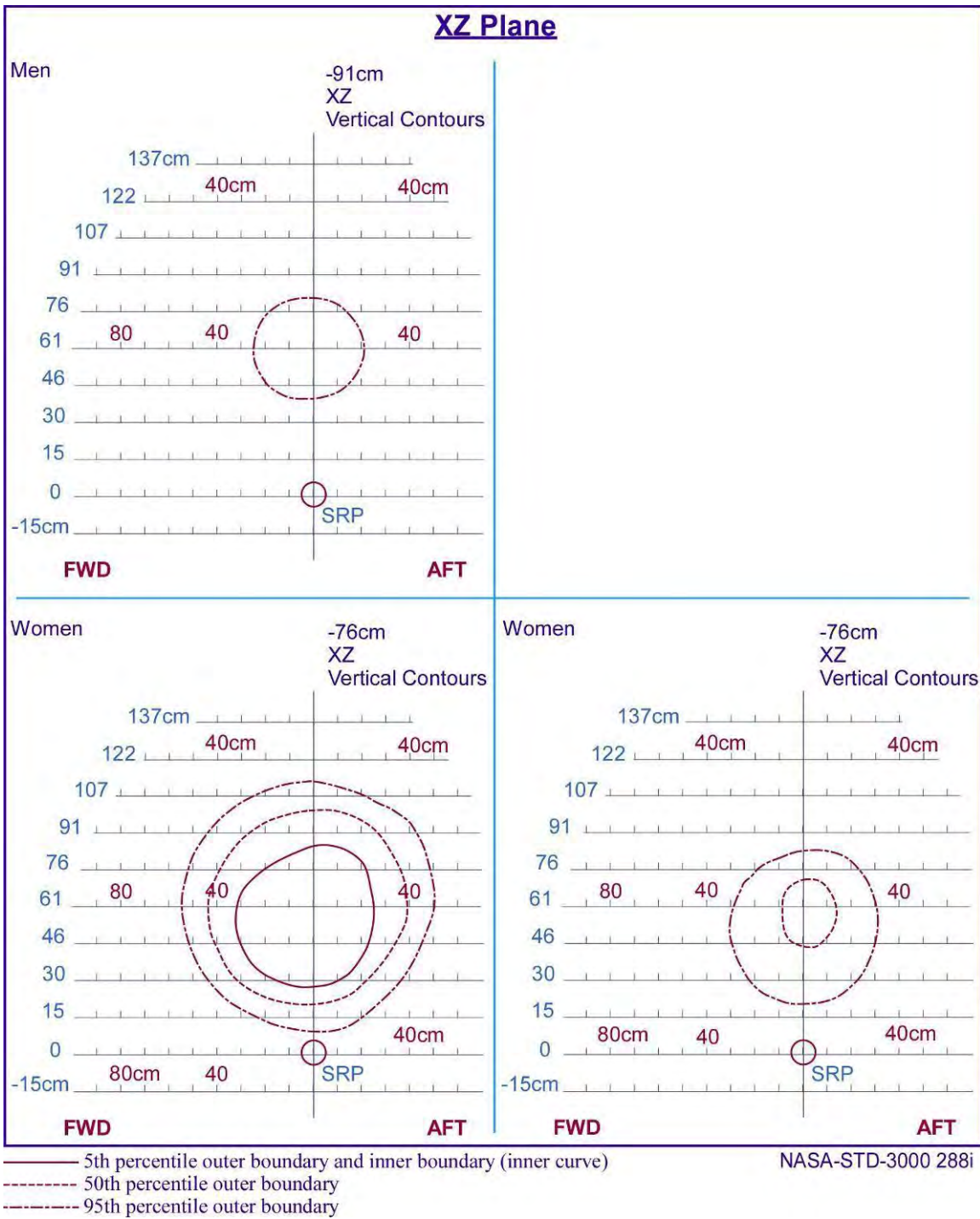


Figure 3b Grasp Reach Limits with Right Hand for American Male and Female Populations (9 of 19)

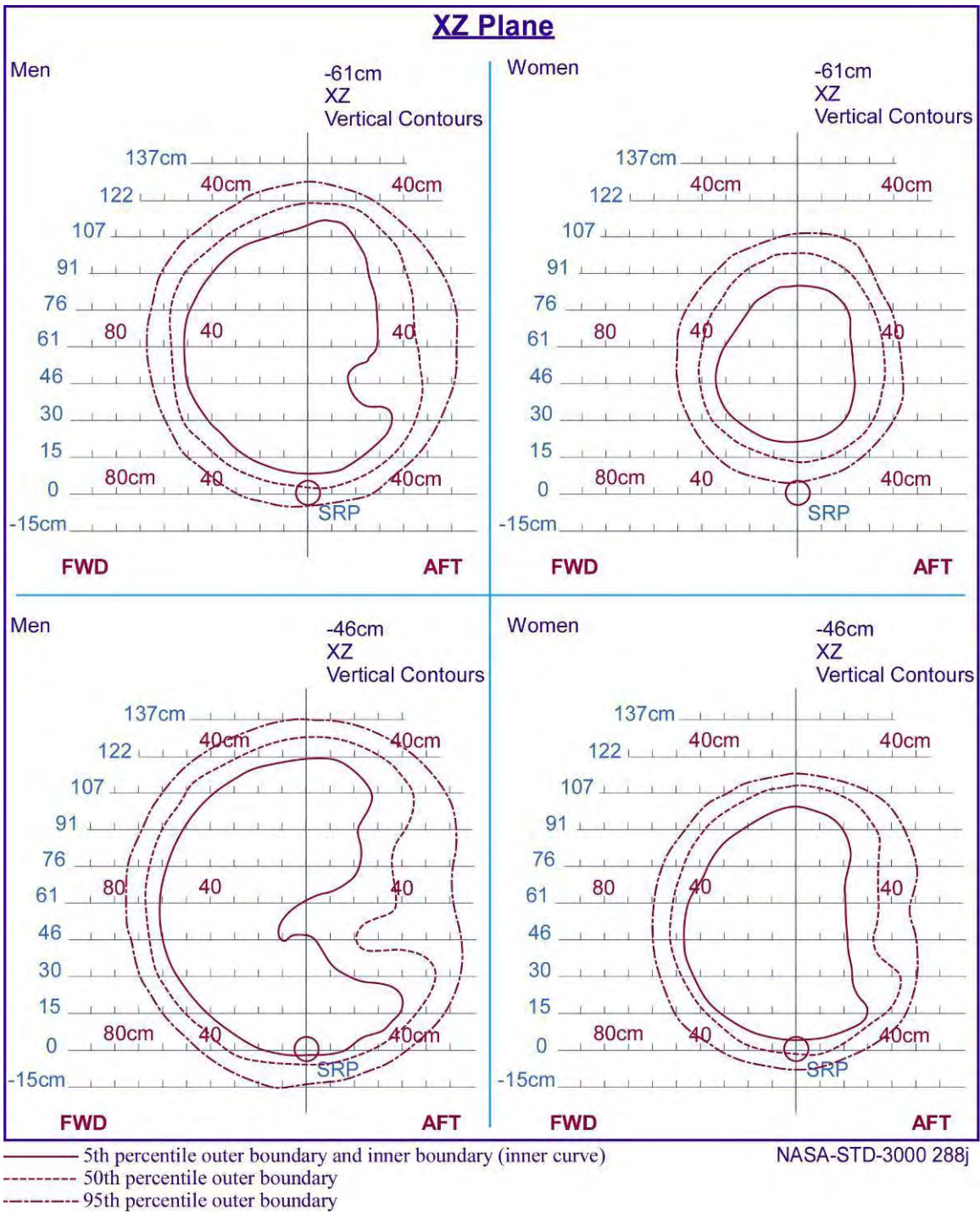


Figure 3b Grasp Reach Limits with Right Hand for American Male and Female Populations (10 of 19)

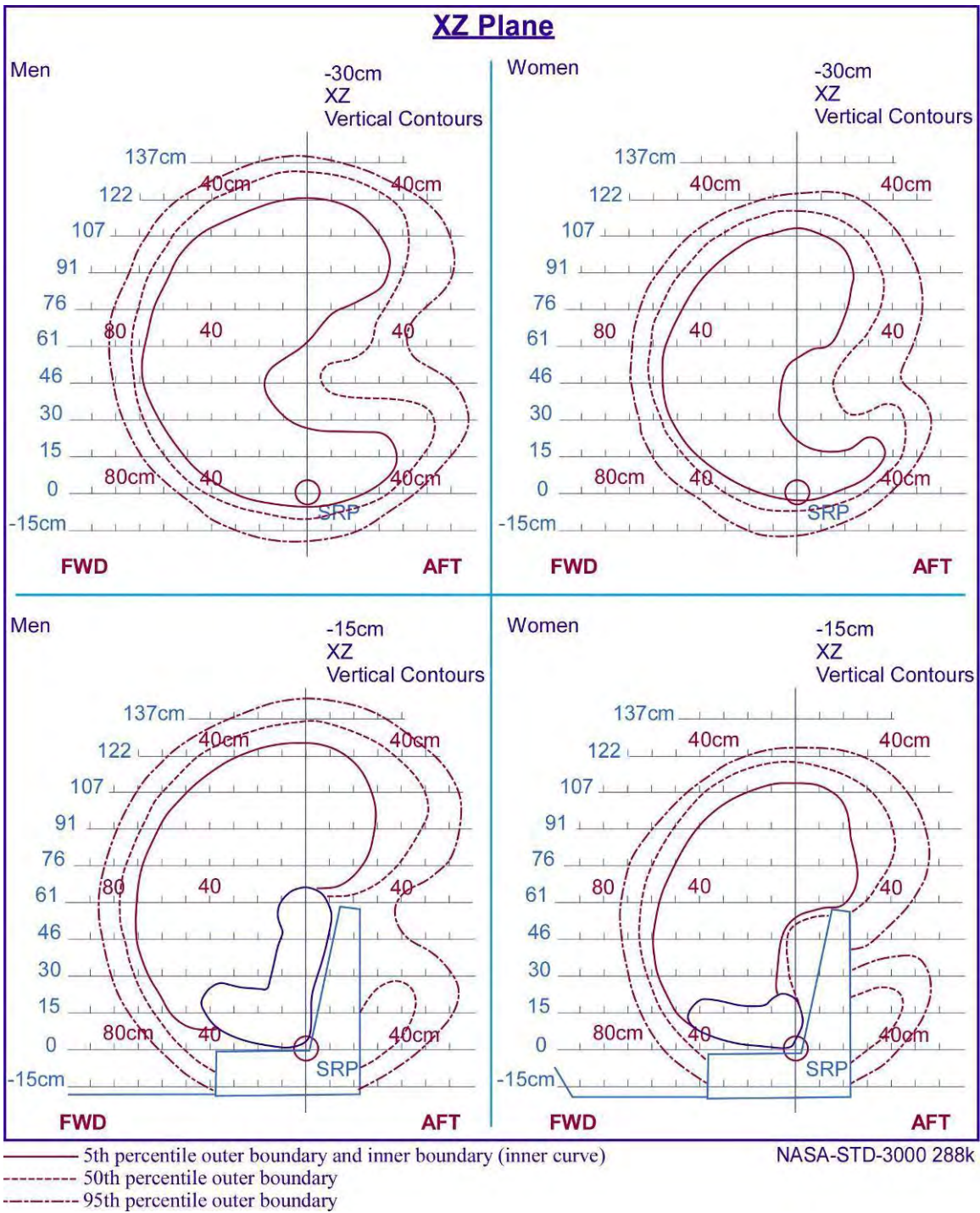


Figure 3b Grasp Reach Limits with Right Hand for American Male and Female Populations (11 of 19)

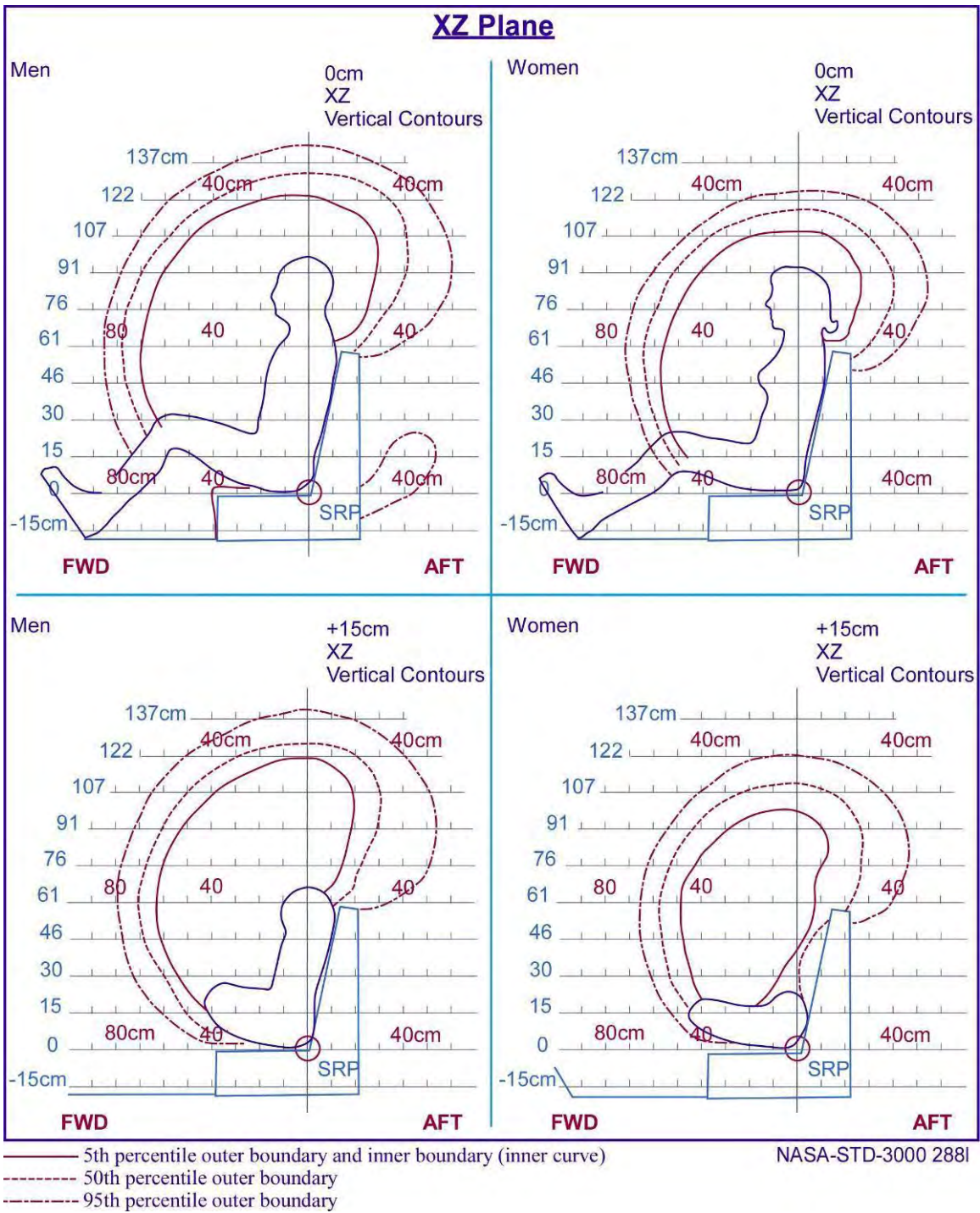


Figure 3b Grasp Reach Limits with Right Hand for American Male and Female Populations (12 of 19)

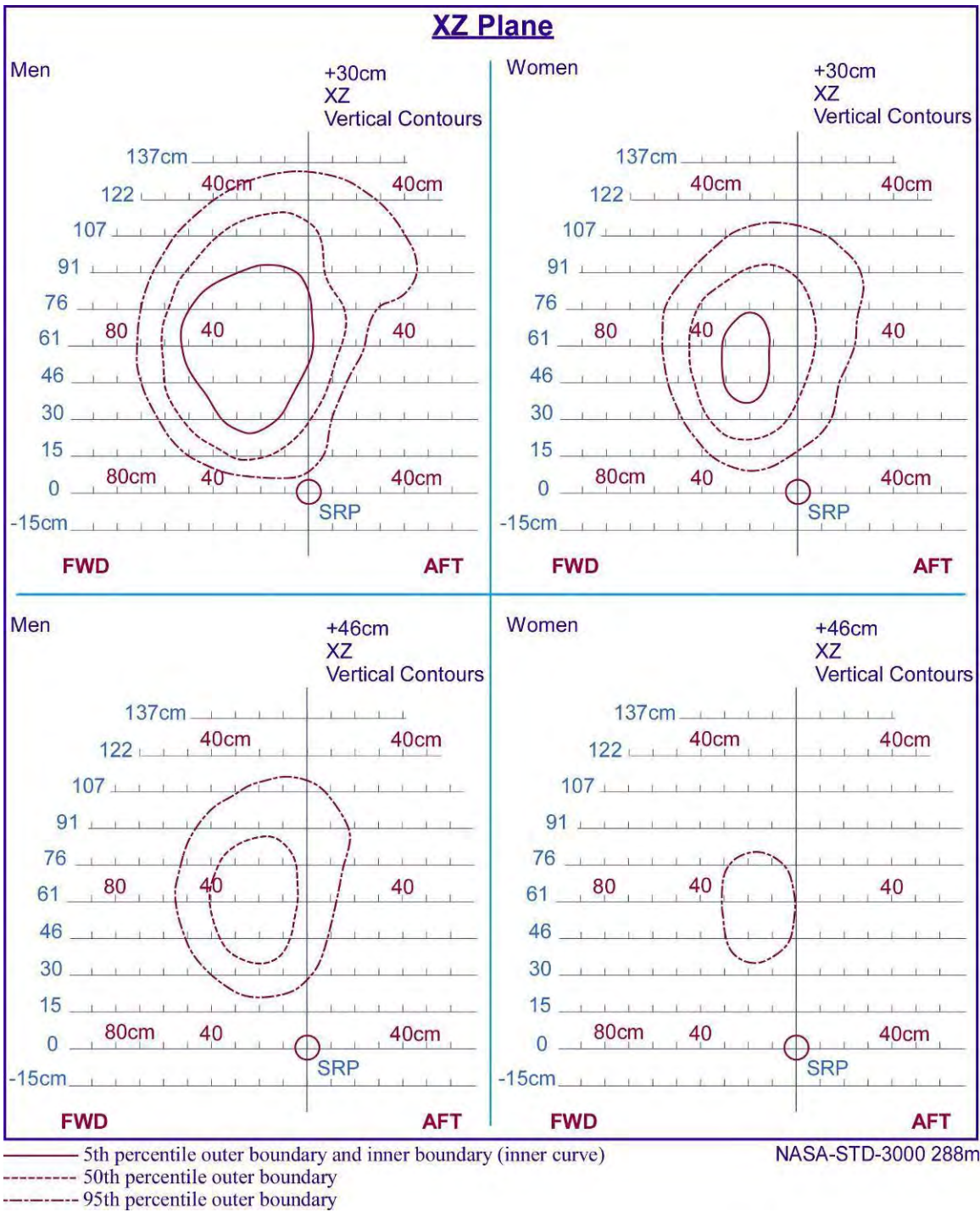
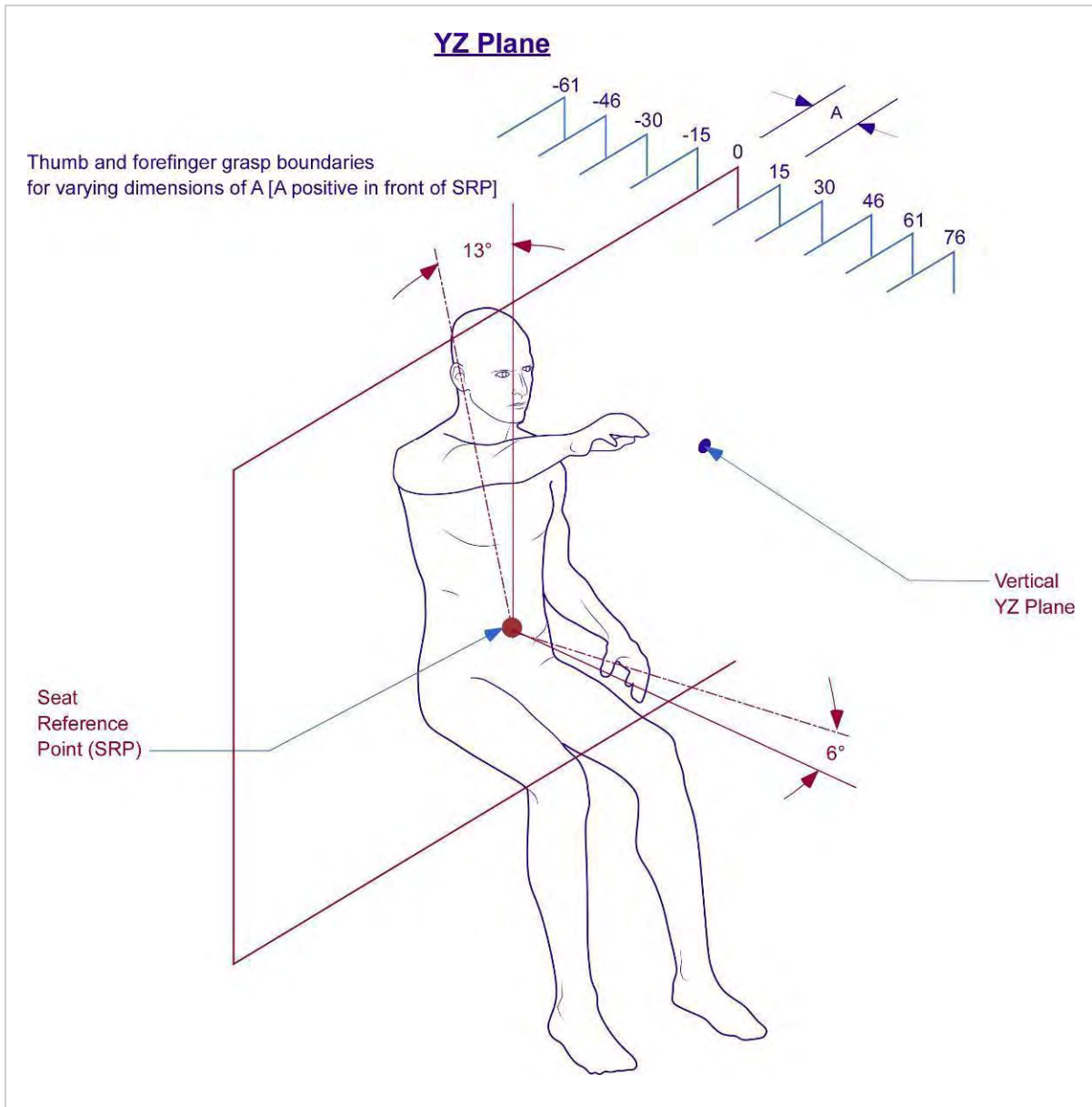


Figure 3b Grasp Reach Limits with Right Hand for American Male and Female Populations (13 of 19)



NASA-STD-3000 288n

Figure 3c Grasp Reach Limits with Right Hand for American Male and Female Populations (14 of 19)

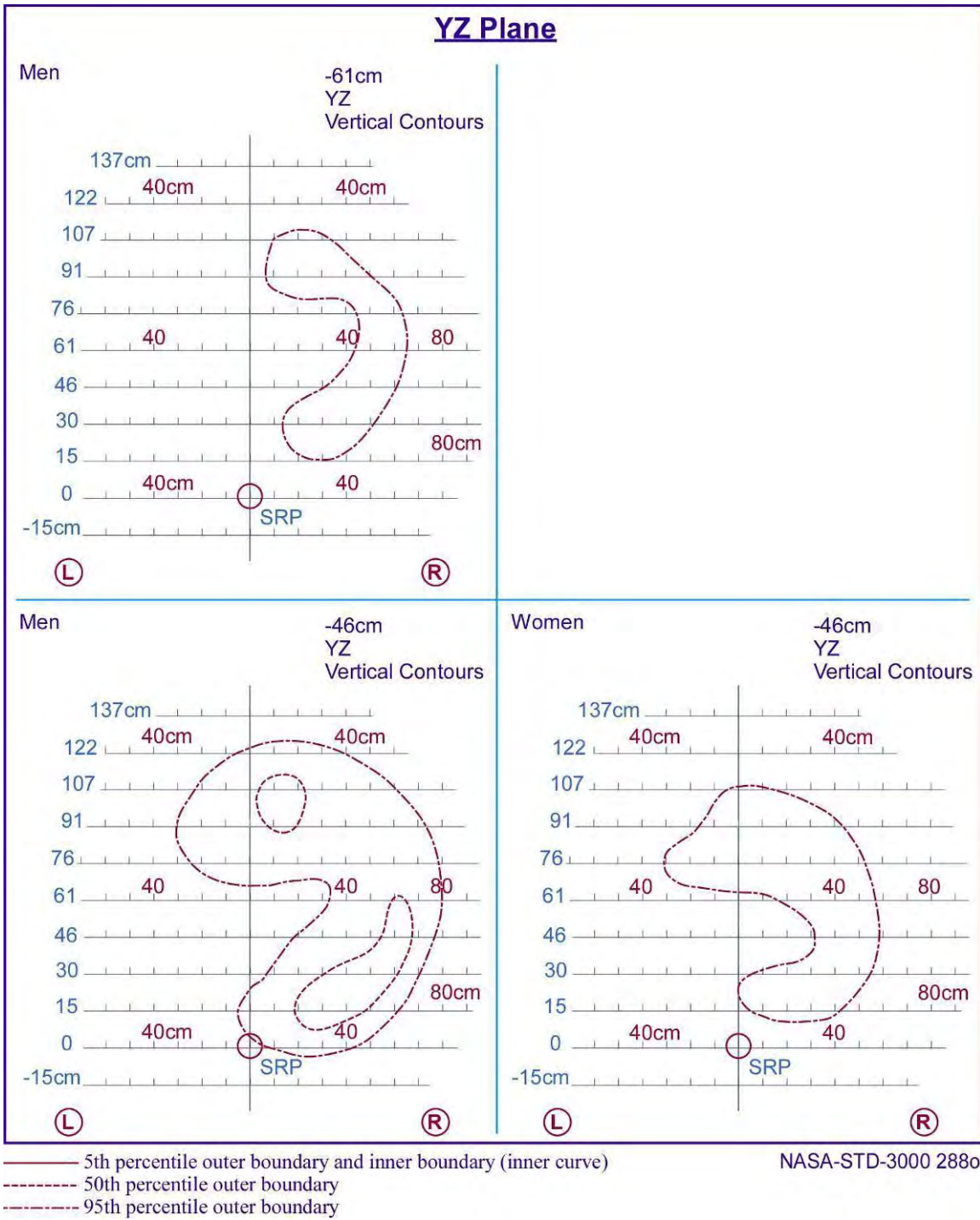
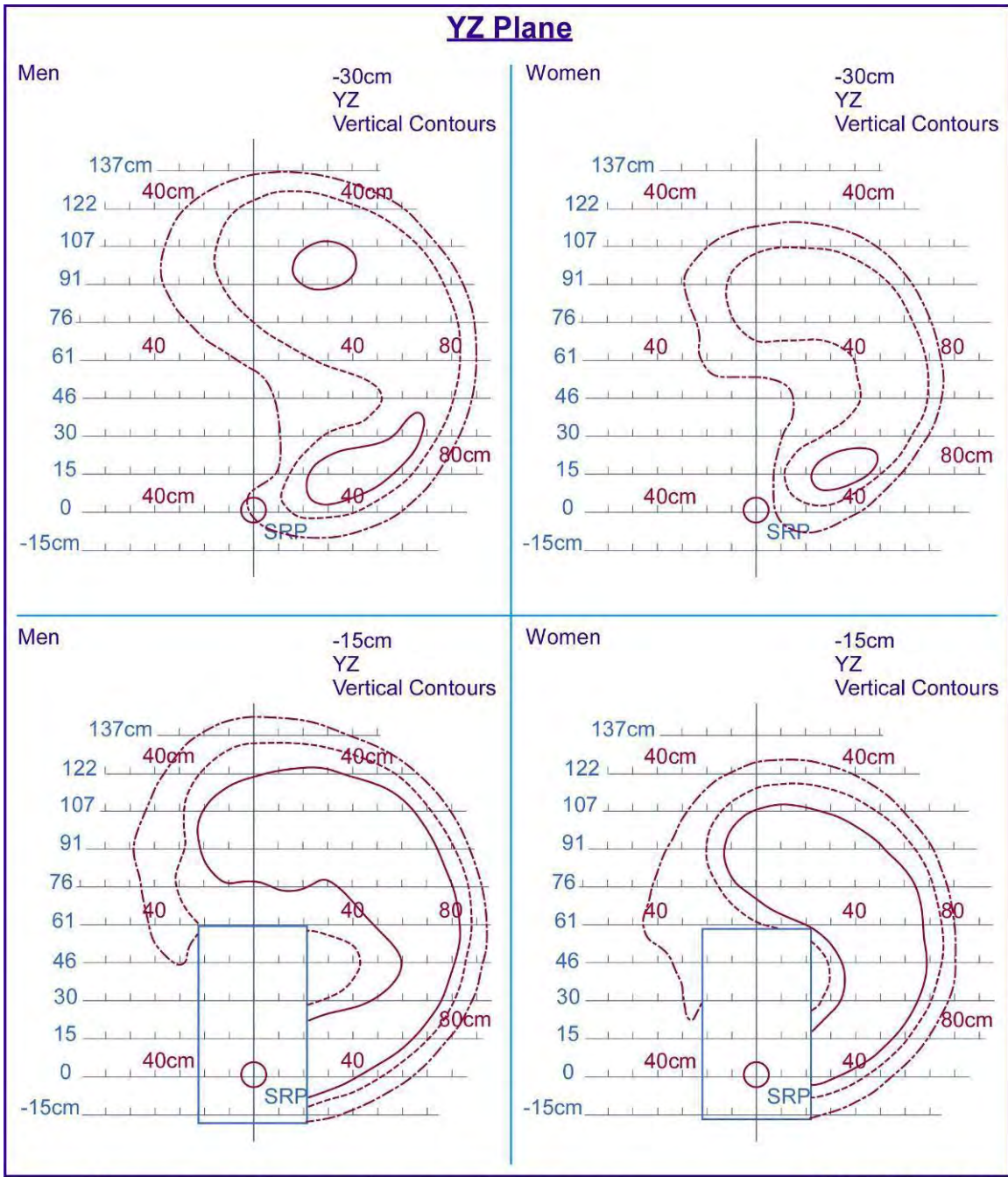


Figure 3c Grasp Reach Limits with Right Hand for American Male and Female Populations (15 of 19)



——— 5th percentile outer boundary and inner boundary (inner curve)
 - - - - - 50th percentile outer boundary
 - · - · - 95th percentile outer boundary

NASA-STD-3000 288p

Figure 3c Grasp Reach Limits with Right Hand for American Male and Female Populations (16 of 19)

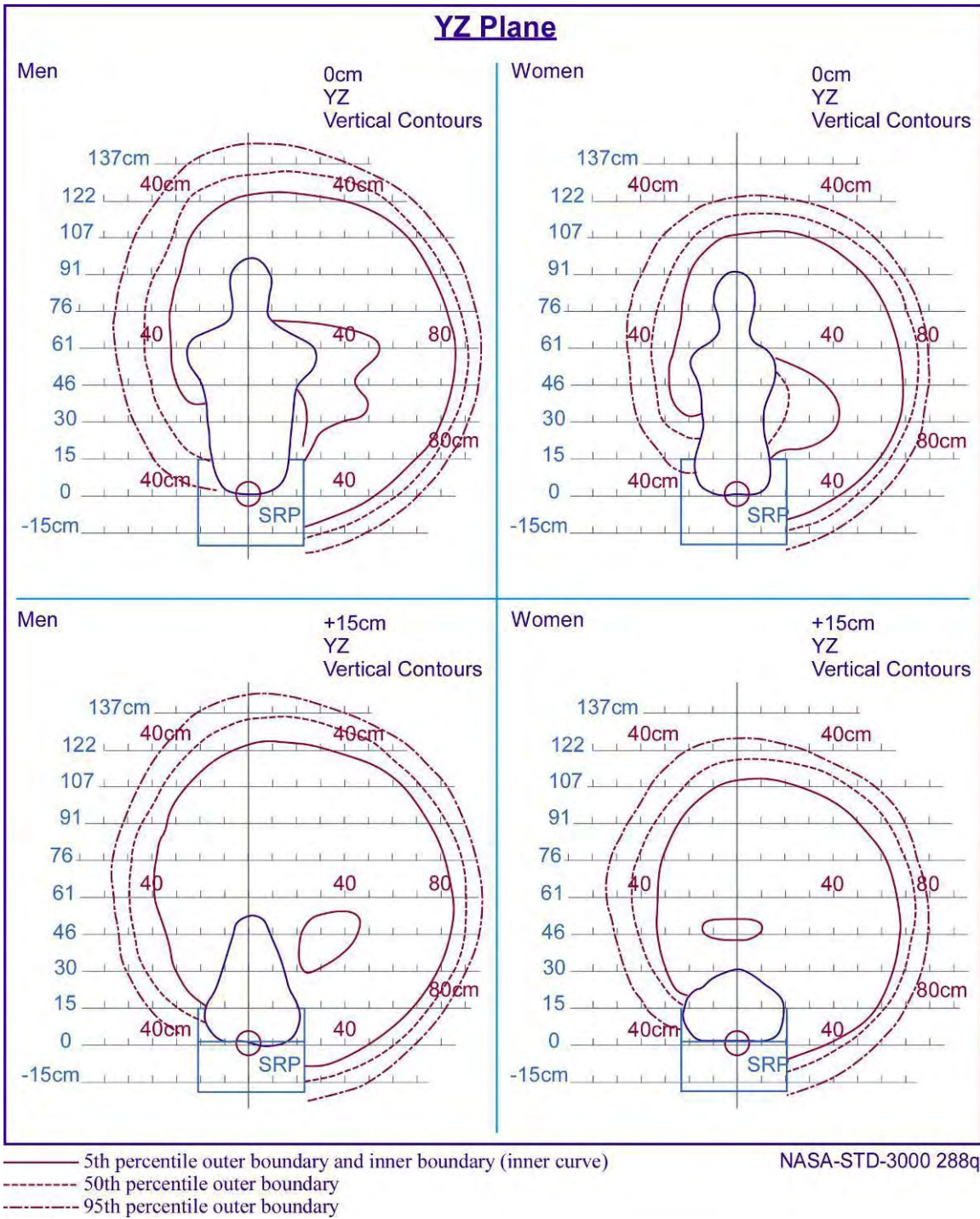
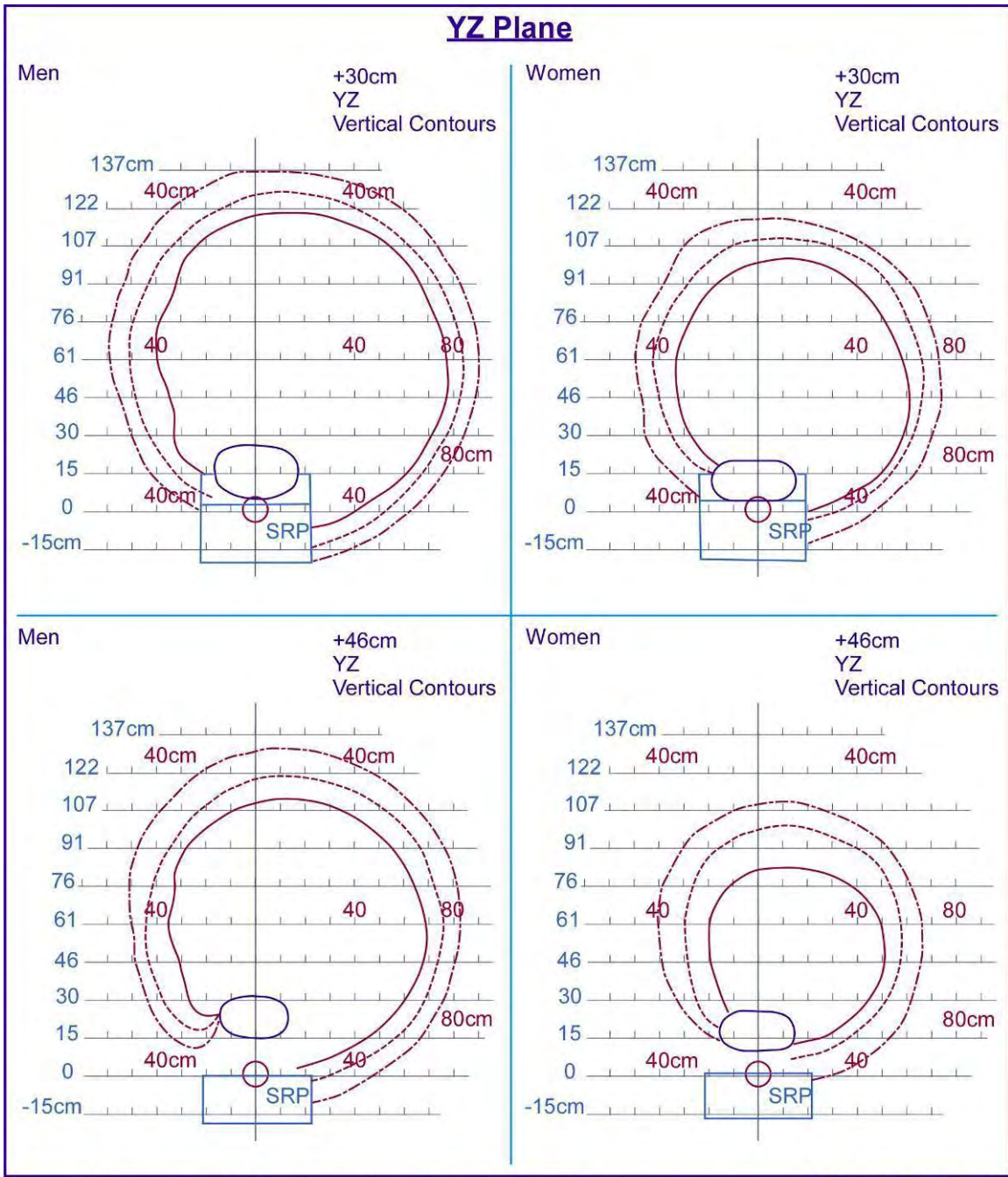
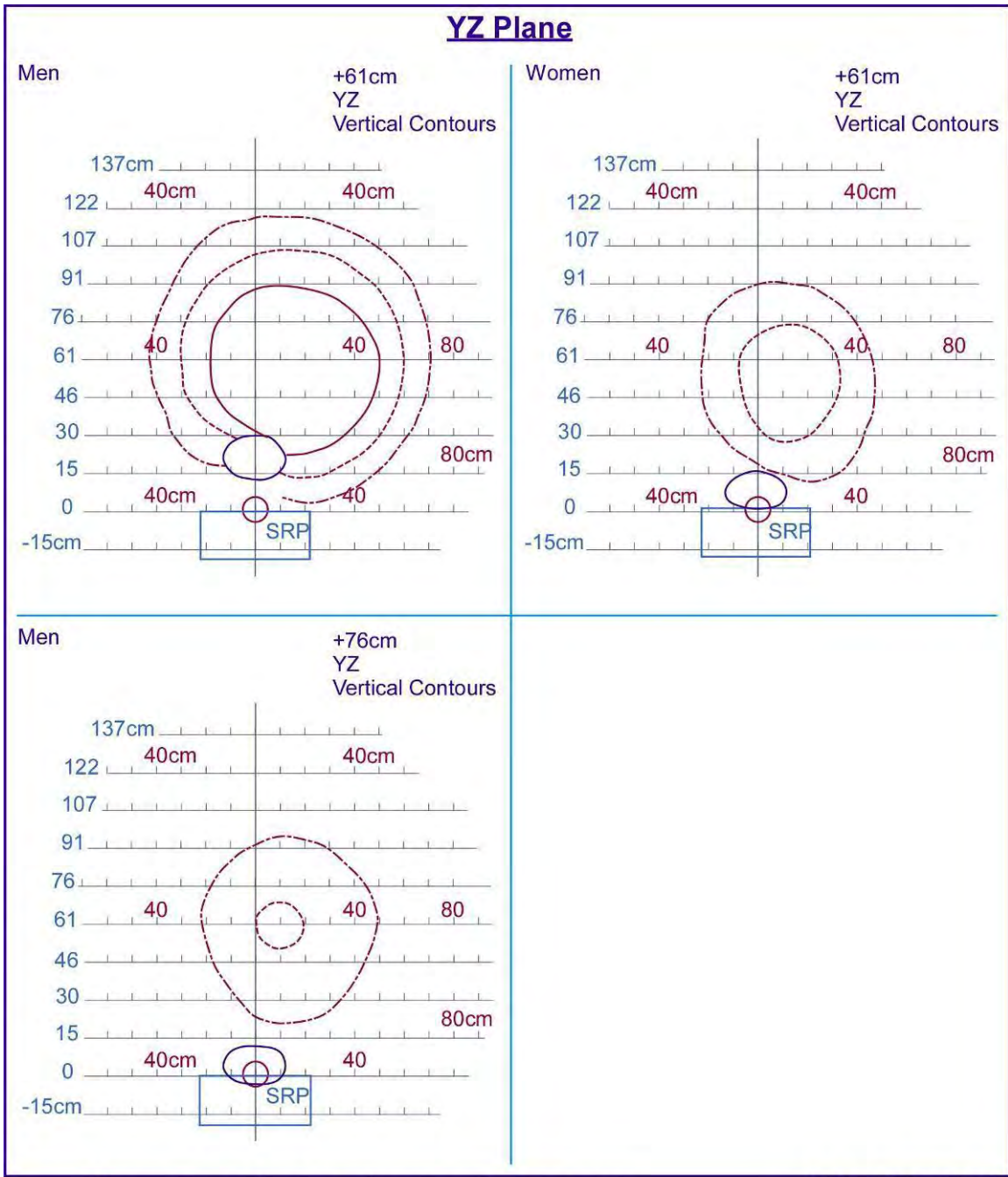


Figure 3c Grasp Reach Limits with Right Hand for American Male and Female Populations (17 of 19)



——— 5th percentile outer boundary and inner boundary (inner curve) NASA-STD-3000 288r
 - - - - - 50th percentile outer boundary
 - . - . - 95th percentile outer boundary

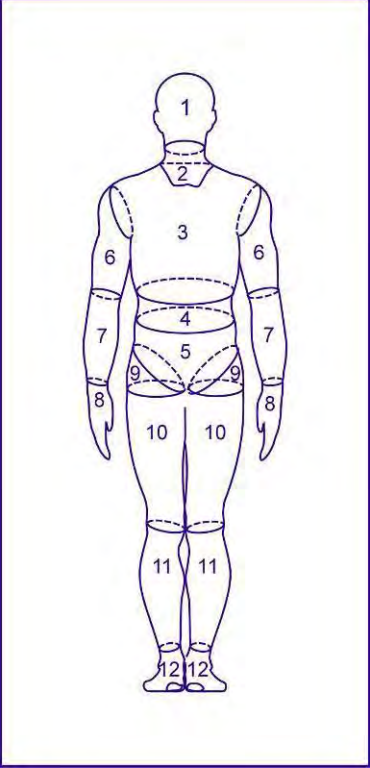
Figure 3c Grasp Reach Limits with Right Hand for American Male and Female Populations (18 of 19)



——— 5th percentile outer boundary and inner boundary (inner curve) NASA-STD-3000 288s
 - - - - - 50th percentile outer boundary
 - · - · - 95th percentile outer boundary

Figure 3c Grasp Reach Limits with Right Hand for American Male and Female Populations (19 of 19)

Table 4 Body Segments Volume of the Male and Female Crewmember

	Segment	Volume, cm ³	
		Female (5th percentile in Height and light Weight)	Male (95th percentile in Height and heavy Weight)
	1 Head	3761	4517
	2 Neck	615	1252
	3 Thorax	14282	30887
	4 Abdomen	2700	2921
	5 Pelvis	7083	14808
	6 Upper arm	1137	2461
	7 Forearm	730	1673
	8 Hand	298	588
	9 Hip flap	2808	4304
	10 Thigh minus flap	4645	7628
	11 Calf	2449	4598
	12 Foot	554	1132
Torso (5 + 4 + 3)	24065	48620	
Thigh (9 + 10)	7454	11930	
Forearm plus hand (7+8)			
		1028	2263

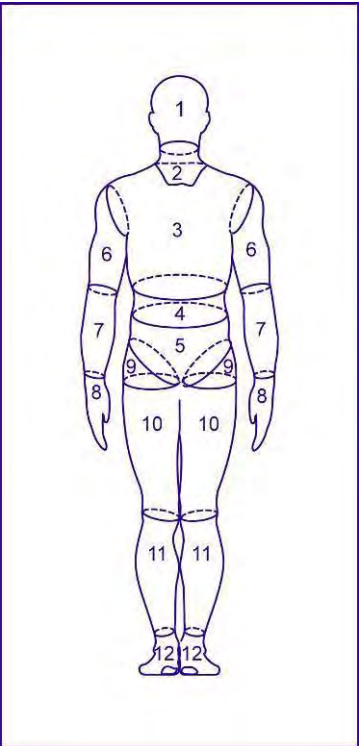
Notes:

1. These data apply to 1-G conditions.
2. American crewmember population is defined in Paragraph X.X.X.X, Anthropometric Database Design requirements.
3. Density assumed constant at 1g-cm-3

References:

1988 Anthropometric Survey of U.S. Army Personnel: Methods and Summary Statistics pp. 32-79; Anthropometric Relationships of Body and Body Segment Moments of Inertia. pp. 18-65; Anthropometrics and Mass Distribution Characteristics of the Adult Female

Table 5 Body Segment Mass Properties for the Male and Female Crewmember

	Segment	Mass, g	
		Female (5th percentile in Height and light Weight)	Male (95th percentile in Height and heavy Weight)
	1 Head	3761	4517
	2 Neck	615	1252
	3 Thorax	14282	30887
	4 Abdomen	2700	2921
	5 Pelvis	7083	14808
	6 Upper arm	1137	2461
	7 Forearm	730	1673
	8 Hand	298	588
	9 Hip flap	2808	4304
	10 Thigh minus flap	4645	7628
	11 Calf	2449	4598
	12 Foot	554	1132
	Torso (5 + 4 + 3)	24065	48620
	Thigh (9 + 10)	7454	11930
	Forearm plus hand (7+8)	1028	2263

Notes:

1. These data apply to 1-G conditions.
2. Density assumed constant at 1g-cm-3

References for Table X.X.X.X.X-X:

1988 Anthropometric Survey of U.S. Army Personnel: Methods and Summary Statistics pp. 32-79; Anthropometric Relationships of Body and Body Segment Moments of Inertia. pp. 18-65; Anthropometrics and Mass Distribution Characteristics of the Adult Female

Table 6 Body Segment Center of Mass Location of the Crewmember

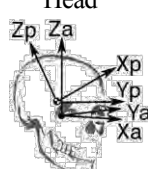
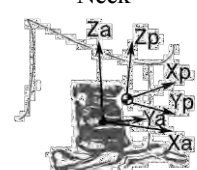
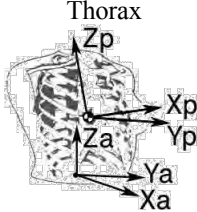

Segment	Axis	Female (5th percentile in Height and light Weight) (cm)	Male (95th percentile in Height and heavy Weight) (cm)
Head 	X	-2.43	0.53
	Y	-0.60	0.60
	Z	2.24	4.05
Neck 	X	3.41	7.31
	Y	-0.56	0.59
	Z	2.93	6.05
Thorax 	X	3.76	7.07
	Y	-0.81	0.49
	Z	13.43	21.98
Abdomen 	X	-1.48	1.54
	Y	-1.65	2.25
	Z	-4.85	-1.15

Table 6 Body Segment Center of Mass Location of the Crewmember (continued)

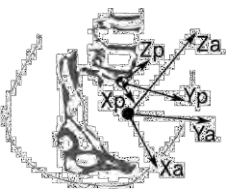
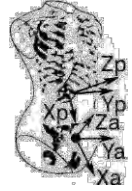
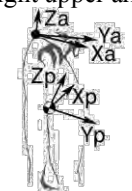
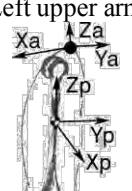
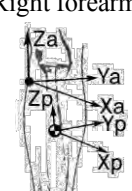
Segment	Axis	Female (5th percentile in Height and light Weight) (cm)	Male (95th percentile in Height and heavy Weight) (cm)
Pelvis 	X	-12.16	-6.96
	Y	-1.32	.74
	Z	-.76	5.18
Torso 	X	-10.42	2.49
	Y	-1.53	1.72
	Z	16.32	25.61
Right upper arm 	X	-0.72	-0.92
	Y	1.85	-2.28
	Z	-18.59	-14.28
Left upper arm 	X	-.64	2.58
	Y	-3.69	-1.80
	Z	-18.73	-14.32
Right forearm 	X	1.01	0.07
	Y	-2.11	4.14
	Z	-9.85	-8.87

Table 6 Body Segment Center of Mass Location of the Crewmember (continued)

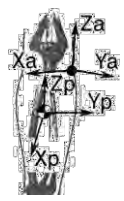
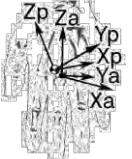
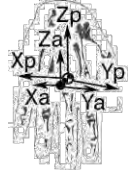
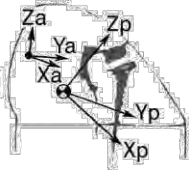
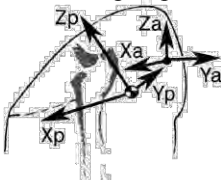
Segment	Axis	Female (5th percentile in Height and light Weight) (cm)	Male (95th percentile in Height and heavy Weight) (cm)
Left forearm 	X	1.17	0.13
	Y	-0.23	-2.45
	Z	-9.86	-9.08
Right hand 	X	-0.54	0.03
	Y	0.43	0.12
	Z	0.71	1.92
Left hand 	X	-0.71	-0.22
	Y	-1.34	0.90
	Z	0.85	2.04
Right hip flap 	X	-7.78	1.70
	Y	5.67	7.37
	Z	-6.74	-6.04
Left hip flap 	X	-8.20	2.42
	Y	-10.67	-5.18
	Z	-6.96	-6.21

Table 6 Body Segment Center of Mass Location of the Crewmember (continued)



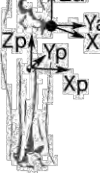
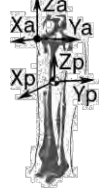
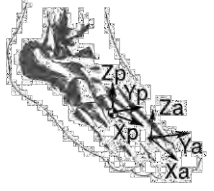
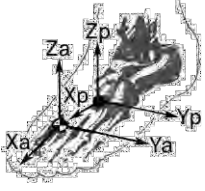

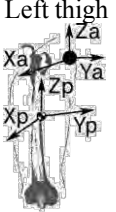
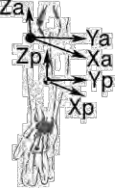

Segment	Axis	Female (5th percentile in Height and light Weight) (cm)	Male (95th percentile in Height and heavy Weight) (cm)
Right thigh minus flap 	X	-3.28	2.36
	Y	5.19	8.38
	Z	-24.84	-23.33
Left thigh minus flap 	X	-3.10	2.22
	Y	-9.59	-5.28
	Z	-24.86	-23.61
Right calf 	X	-4.23	-0.11
	Y	-6.38	-4.85
	Z	-16.17	-12.02
Left calf 	X	-4.34	0.68
	Y	4.04	6.83
	Z	-16.00	-12.31
Right foot 	X	-8.50	-6.62
	Y	-0.27	0.44
	Z	0.45	-0.05

Table 6 Body Segment Center of Mass Location of the Crewmember (continued)

Segment	Axis	Female (5th percentile in Height and light Weight) (cm)	Male (95th percentile in Height and heavy Weight) (cm)
Left foot 	X	-8.70	-6.47
	Y	-0.86	0.88
	Z	0.32	-0.11
Right thigh 	X	-4.88	2.11
	Y	5.63	8.01
	Z	-17.55	-17.54
Left thigh 	X	-4.75	2.29
	Y	-9.64	-5.26
	Z	-17.91	-17.82
Right forearm plus hand 	X	0.44	-0.35
	Y	-2.28	4.51
	Z	-15.55	-14.98
Left forearm plus hand 	X	0.44	-0.01
	Y	0.79	-2.81
	Z	-15.37	-15.00

Notes for Table X.X.X.X.X-X:

1. These data apply to 1-G conditions.
2. Density assumed constant at 1g-cm-3

References:

1988 Anthropometric Survey of U.S. Army Personnel: Methods and Summary Statistics pp. 32-79; Anthropometric Relationships of Body and Body Segment Moments of Inertia. pp. 18-65; Anthropometrics and Mass Distribution Characteristics of the Adult Female

Table 7 **Body Segment Moment of Inertia of the Crewmember**

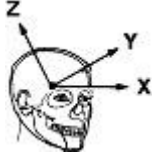
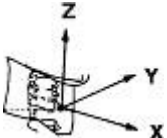
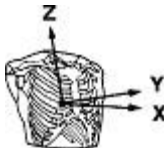
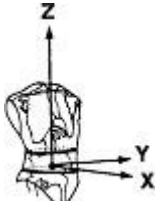
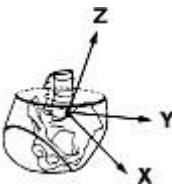
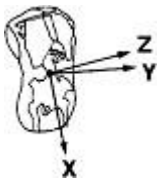
Segment	Axis	5th percentile Light Female X 10 ⁻³ (kg-m ²)	95th percentile Heavy Male X 10 ⁻³ (kg-m ²)
Head 	Xp	14.81	21.56
	Yp	17.85	24.74
	Zp	13.58	15.97
Neck 	Xp	0.72	2.25
	Yp	0.98	2.69
	Zp	1.06	3.41
Thorax 	Xp	183.14	679.88
	Yp	135.10	505.00
	Zp	119.39	431.33
Abdomen 	Xp	14.61	22.74
	Yp	10.17	13.01
	Zp	21.08	34.79
Pelvis 	Xp	46.01	148.07
	Yp	34.12	137.28
	Zp	60.68	172.94
Torso 	Xp	638.13	2030.22
	Yp	577.40	1839.60
	Zp	205.01	643.61

Table 7 Body Segment Moment of Inertia of the Crewmember (continued)


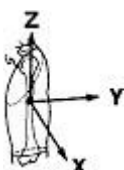
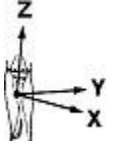
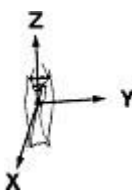
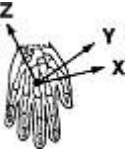
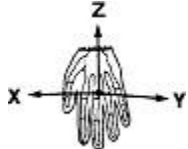
Segment	Axis	5th percentile Light Female X 10 ⁻³ (kg-m ²)	95th percentile Heavy Male X 10 ⁻³ (kg-m ²)
Right upper arm 	Xp	5.42	18.11
	Yp	5.62	19.48
	Zp	1.00	3.86
Left upper arm 	Xp	5.31	17.68
	Yp	5.47	18.94
	Zp	0.94	3.75
Right forearm 	Xp	2.84	11.64
	Yp	2.75	11.87
	Zp	0.48	1.83
Left forearm 	Xp	2.78	10.83
	Yp	2.66	11.18
	Zp	0.46	1.64
Right hand 	Xp	0.57	1.61
	Yp	0.48	1.31
	Zp	0.17	0.53
Left hand 	Xp	0.62	1.57
	Yp	0.53	1.30
	Zp	0.17	0.51

Table 7 Body Segment Moment of Inertia of the Crewmember (continued)



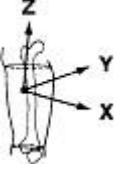
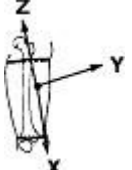
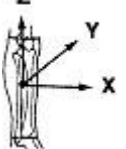
Segment	Axis	5th percentile Light Female X 10-3 (kg-m ²)	95th percentile Heavy Male X 10-3 (kg-m ²)
Right hip flap 	Xp	8.03	17.37
	Yp	10.36	22.35
	Zp	13.38	29.34
Left hip flap 	Xp	7.91	16.77
	Yp	10.73	21.86
	Zp	13.67	28.29
Right thigh minus flap 	Xp	33.71	79.45
	Yp	33.10	81.79
	Zp	13.76	31.74
Left thigh minus flap 	Xp	33.63	75.19
	Yp	33.25	79.14
	Zp	13.34	30.74
Right calf 	Xp	25.90	75.44
	Yp	25.85	76.50
	Zp	3.06	8.84

Table 7 Body Segment Moment of Inertia of the Crewmember (continued)

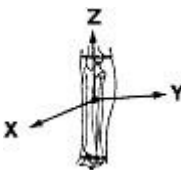
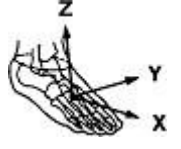

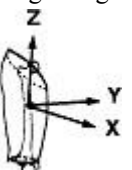
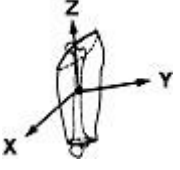
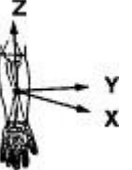
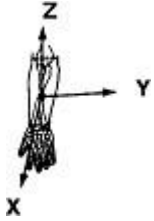
Segment	Axis	5th percentile Light Female X 10 ⁻³ (kg-m ²)	95th percentile Heavy Male X 10 ⁻³ (kg-m ²)
Left calf 	Xp	25.87	76.95
	Yp	25.92	78.16
	Zp	2.97	9.06
Right foot 	Xp	0.37	1.03
	Yp	1.58	5.47
	Zp	1.66	5.80
Left foot 	Xp	0.37	1.00
	Yp	1.63	5.36
	Zp	1.72	5.63
Right thigh 	Xp	84.64	208.18
	Yp	86.94	219.78
	Zp	27.43	59.03
Left thigh 	Xp	85.2	200.48
	Yp	88.00	211.73
	Zp	27.36	56.87
Right forearm plus hand 	Xp	11.02	39.56
	Yp	10.81	39.42
	Zp	0.68	2.43

Table 7 Body Segment Moment of Inertia of the Crewmember (continued)

Segment	Axis	5th percentile Light Female X 10-3 (kg-m ²)	95th percentile Heavy Male X 10-3 (kg-m ²)
Left forearm plus hand 	Xp	10.96	37.38
	Yp	10.78	37.13
	Zp	0.65	2.23

Notes for Table 3.5.3.5.2-1:

1. These data apply to 1-G conditions.
2. American crewmember population is defined in Paragraph 3.2.3.1, Anthropometric Database Design requirements.
3. Density assumed constant at 1g-cm-3
4. The X, Y, and Z in these figures refer to the principal axes.

References:

1988 Anthropometric Survey of U.S. Army Personnel: Methods and Summary Statistics
 pp. 32-79; Anthropometric Relationships of Body and Body Segment Moments of Inertia.
 pp. 18-65; Anthropometrics and Mass Distribution Characteristics of the Adult Female

Table 8 Unsuit Strength Data

- Criticality 1 load limits to be used for crew safety situations and the design of items where a single failure could result in loss of life or vehicle.
- Criticality 2 load limits to be used for the design of items where a single failure could result in a loss of mission.



Type Of Strength		Minimum Crew Operation Loads (N(Lbf))			Maximum Crew Operational Loads (N(Lbf))
		Crit 1 Operations	Crit 2 Operations	Other Operations	
One Handed Pulls		One Handed Pulls			
Seated Horizontal Pull In ² [Subject in a seated position pulls towards his/her body. Unilateral/Isometric measurement]		111 (25)	147 (33)	276 (62)	449 (101)
Seated Vertical Pull Down ² [Subject in a seated position pulls downwards. Unilateral/Isometric measurement]		125 (28)	165 (37)	311 (70)	587 (132)

Table 8 Unsuiting Strength Data - continued




Type Of Strength		Minimum Crew Operation Loads (N(Lbf))			Maximum Crew Operational Loads (N(Lbf))
		Crit 1 Operations	Crit 2 Operations	Other Operations	
Seated Vertical Pull Up ² [Sitting erect with feet apart, dominant hand grasping D-ring located directly to the front above the floor, pulling upward while keeping shoulder squares & other arm in lap]		49 (11)	67 (15)	125 (28)	756 (170)
Standing Vertical Pull Up ² [Standing erect with feet apart, dominant hand grasping underside of D-ring located directly to the side above standing surface, pulling upward while keeping shoulders square and other arm relaxed at side]		53 (12)	71 (16)	133 (30)	725 (163)
Two Handed Pulls		Two Handed Pulls			
Standing Vertical Pull Down ² [Standing erect with feet apart, with both hands holding handle located above shoulders, pulling downward]		138 (31)	182 (41)	343 (77)	707 (159)

Table 8 Unsuiting Strength Data - continued




Type Of Strength		Minimum Crew Operation Loads (N(Lbf))			Maximum Crew Operational Loads (N(Lbf))
		Crit 1 Operations	Crit 2 Operations	Other Operations	
Standing Pull in ² [Standing erect with feet apart, with both hands holding handle located in front, pulling inward towards body]		58 (13)	80 (18)	147 (33)	391 (88)
Standing Vertical Pull Up ² [Standing with feet apart with a slight bend at the knees and waist, grasping a handle with both hands located directly in front and pulling upward]		89 (20)	116 (26)	218 (49)	1437 (323)
Seated Vertical Pull Up ² [Sitting erect with feet apart, grasping both sides of handle located directly to the front above the floor, pulling upward using arms and shoulders]		93 (21)	125 (28)	236 (53)	1188 (267)

Table 8 Unsuiting Strength Data - continued




Type Of Strength		Minimum Crew Operation Loads (N(Lbf))			Maximum Crew Operational Loads (N(Lbf))
		Crit 1 Operations	Crit 2 Operations	Other Operations	
One Handed Push		One Handed Push			
Seated Horizontal Push Out ² [Subject in a seated position pushing away from his/her body. Unilateral/Isometric measurement]		89 (20)	116 (26)	218 (49)	436 (98)
Seated Vertical Push Up ² [Subject in a seated position pushing upward in a vertical direction. Unilateral/Isometric measurement]		67 (15)	85 (19)	160 (36)	280 (63)
Two Handed Push		Two Handed Push			
Standing Vertical Push Down ² [Standing with feet apart with a slight bend at the knees and waist, grasping a handle with both hands located directly in front and pushing downwards]		102 (23)	133 (30)	254 (57)	525 (118)

Table 8 Unsuiting Strength Data - continued



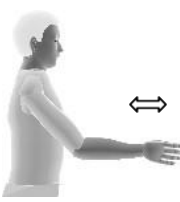
Type Of Strength		Minimum Crew Operation Loads (N(Lbf))			Maximum Crew Operational Loads (N(Lbf))
		Crit 1 Operations	Crit 2 Operations	Other Operations	
One Handed Push		One Handed Push			
Standing Horizontal Push Out ¹ [Standing erect with feet apart, with both hands holding handle located in front, pushing out away from body]		62 (14)	85 (19)	165 (37)	596 (134)
Standing Vertical Push Up ² [Standing erect with feet apart, grasping from below, both sides of handle located directly in front above standing surface. Pushing upwards using arms and shoulders]		76 (17)	98 (22)	187 (42)	1094 (246)
Arm		Arm			
Arm Pull ² [Subject pulls handle forward and backward]		44 (10)	58 (13)	107 (24)	249 (56)
Arm Push ² [Subject pushes handle forward and backward]		40 (9)	53 (12)	98 (22)	222 (50)

Table 8 Unsuiting Strength Data - continued

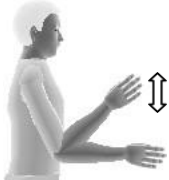
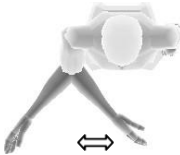
Type Of Strength		Minimum Crew Operation Loads (N(Lbf))			Maximum Crew Operational Loads (N(Lbf))
		Crit 1 Operations	Crit 2 Operations	Other Operations	
One Handed Push		One Handed Push			
Arm Up ² [Subject pushes and pulls handle in a various directions as shown by the figures]		18 (4)	22 (5)	40 (9)	107 (24)
Arm Down ² [Subject pushes and pulls handle in a various directions as shown by the figures]		22 (5)	31 (7)	58 (13)	116 (26)
Arm		Arm			
Arm In ² [Subject moves handle medially]		22 (5)	31 (7)	58 (13)	98 (22)
Arm Out ² [Subject moves handle laterally]		13 (3)	18 (4)	36 (8)	76 (17)

Table 8 Unsuiting Strength Data - continued



Type Of Strength		Minimum Crew Operation Loads (N(Lbf))			Maximum Crew Operational Loads (N(Lbf))
		Crit 1 Operations	Crit 2 Operations	Other Operations	
One Handed Push		One Handed Push			
Lifting		Lifting			
Lifting Strength ² [Standing with feet apart with a slight bend at the knees and waist, grasping a handle with both hands located directly in front and pulling upward using primarily arms and shoulders, and legs]		36 (8)	49 (11)	93 (21)	1228 (276)
Elbow		Elbow			
Flexion ² [Subject moves forearm in a sagittal plane around the elbow joint]		13 (3)	18 (4)	36 (8)	347 (78)
Extension ² [Subject moves forearm in a sagittal plane around the elbow joint]		27 (6)	36 (8)	67 (15)	249 (56)

Table 8 Unsited Strength Data - continued

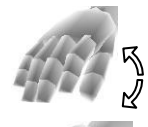


Type Of Strength		Minimum Crew Operation Loads (N(Lbf))			Maximum Crew Operational Loads (N(Lbf))
		Crit 1 Operations	Crit 2 Operations	Other Operations	
One Handed Push		One Handed Push			
Pronation ² [Subject rotates hands and forearms medially]		165 (37)	222 (50)	414 (93)	876 (197)
Supination ² [Subject rotates hands and forearms laterally]			160 (36)	214 (48)	405 (91)
Wrist & Hand		Wrist & Hand			
Wrist Flexion ² [Subject bends wrist in a palmar direction]		31 (7)	40 (9)	76 (17)	209 (47)
Wrist Extension ² [Subject bends the wrist in a dorsal direction]		13 (3)	18 (4)	36 (8)	85 (19)

Table 8 Unsuiting Strength Data - continued






Type Of Strength		Minimum Crew Operation Loads (N(Lbf))			Maximum Crew Operational Loads (N(Lbf))
		Crit 1 Operations	Crit 2 Operations	Other Operations	
Pinch ¹ [Subject squeezes together the thumb and finger]		9 (2)	13 (3)	18 (4)	200 (45)
Grasp ¹ [Subject maintains an eccentric tight hold of an object]		347 (78)	463 (104)	694 (156)	1219 (274)
Grip ¹ [Subject maintains a concentric tight hold of an object t]		49 (11)	67 (15)	102 (23)	783 (176)
Leg		Leg			
Hip Flexion ² [Subject moves leg in the sagittal plane around the hip joint toward the front of the body]		116 (26)	156 (35)	289 (65)	645 (145)
Hip Extension ² [Subject moves upper and lower leg in a sagittal plane around the hip joint]		191 (43)	254 (57)	476 (107)	658 (148)

Table 8 Unsuiting Strength Data - concluded

Type Of Strength		Minimum Crew Operation Loads (N(Lbf))			Maximum Crew Operational Loads (N(Lbf))
		Crit 1 Operations	Crit 2 Operations	Other Operations	
Leg Press ¹ [Subject moves leg in a sagittal plane around the hip joint toward the back of the body]		618 (139)	827 (186)	1552 (349)	2584 (581)
Knee Flexion ¹ [Subject moves lower leg in a sagittal plane around the knee joint]		53 (12)	71 (16)	138 (31)	325 (73)
Knee Extension ¹ [Subject moves lower leg in a sagittal plane around the knee joint]		142 (32)	191 (43)	383 (86)	783 (176)

¹ Post-space flight maximal measured strength decrement.

² Post-space flight estimated strength decrement. Range is 0%-26%. Average estimated is 20%. Based on max EDOMP Data. Not all motions were measured on EDOMP.

Table 9 UnPressurized suited Strength Data





Type of Strength		Minimum Crew Operational Loads- N (lbf)			Maximum Crew Operational Loads- N (lbf)
		Crit 1 Operations	Crit 2 Operations	Other Operations	
One Handed Pulls		One Handed Pulls			
Seated Horizontal Pull In ² [Subject in a seated position pulls towards his/her body. Unilateral/Isometric measurement]		78(18)	103(23)	193(43)	314(71)
Seated Vertical Pull Down ² [Subject in a seated position pulls downwards. Unilateral/Isometric measurement]		88(20)	116(26)	218(49)	411(92)
Seated Vertical Pull Up ² [Sitting erect with feet apart, dominant hand grasping D-ring located directly to the front above the floor, pulling upward while keeping shoulder squares & other arm in lap]		34(8)	47(11)	88(20)	529(119)
Standing Vertical Pull Up ² [Standing erect with feet apart, dominant hand grasping underside of D-ring located directly to the side above standing surface, pulling upward while keeping shoulders square and other arm relaxed at side]		37(8)	50(11)	93(21)	508(114)

Table 9 UnPressurized suited Strength Data - continued





Type of Strength		Minimum Crew Operational Loads- N (lbf)			Maximum Crew Operational Loads- N (lbf)
		Crit 1 Operations	Crit 2 Operations	Other Operations	
Two Handed Pulls		Two Handed Pulls			
Standing Vertical Pull Down ² [Standing erect with feet apart, with both hands holding handle located above shoulders, pulling downward]		97(22)	127(29)	240(54)	495(111)
Standing Pull in ² [Standing erect with feet apart, with both hands holding handle located in front, pulling inward towards body]		41(9)	56(13)	103(23)	274(62)
Standing Vertical Pull Up ² [Standing with feet apart with a slight bend at the knees and waist, grasping a handle with both hands located directly in front and pulling upward]		62(14)	81(18)	153(34)	1006(226)
Seated Vertical Pull Up ² [Sitting erect with feet apart, grasping both sides of handle located directly to the front above the floor, pulling upward using arms and shoulders]		65(15)	88(20)	165(37)	832(187)

Table 9 UnPressurized suited Strength Data - continued





Type of Strength		Minimum Crew Operational Loads- N (lbf)			Maximum Crew Operational Loads- N (lbf)
Two Handed Pulls		Two Handed Pulls			
Seated Vertical Push Up ² [Subject in a seated position pushing upward in a vertical direction. Unilateral/Isometric measurement]		47(11)	60(13)	112(25)	196(44)
Two Handed Push		Two Handed Push			
Standing Vertical Push Down ² [Standing with feet apart with a slight bend at the knees and waist, grasping a handle with both hands located directly in front and pushing downwards]		71(16)	93(21)	178(40)	368(83)
Standing Horizontal Push Out ¹ [Standing erect with feet apart, with both hands holding handle located in front, pushing out away from body]		43(10)	60(13)	116(26)	417(94)
Standing Vertical Push Up ² [Standing erect with feet apart, grasping from below, both sides of handle located directly in front above standing surface. Pushing upwards using arms and shoulders]		53(12)	69(15)	131(29)	766(172)

Table 9 UnPressurized suited Strength Data - continued

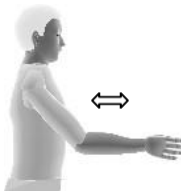

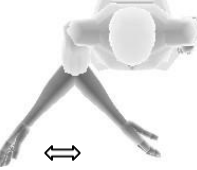

Type of Strength		Minimum Crew Operational Loads- N (lbf)			Maximum Crew Operational Loads- N (lbf)
Arm		Arm			
Arm Pull ² [Subject pulls handle forward and backward]		31(7)	41(9)	75(17)	174(39)
Arm Push ² [Subject pushes handle forward and backward]		28(6)	37(8)	69(15)	155(35)
Arm Up ² [Subject moves handle up]		13(3)	15(4)	28(6)	75(17)
Arm Down ² [Subject moves handle down]		15(4)	22(5)	41(9)	81(18)
Arm In ² [Subject moves handle medially]		15(4)	22(5)	41(9)	69(15)
Arm Out ² [Subject moves handle laterally]		9(2)	13(3)	25(6)	53(12)
Lifting		Lifting			
Lifting Strength ² [Standing with feet apart with a slight bend at the knees and waist, grasping a handle with both hands located directly in front and pulling upward using primarily arms and shoulders, and legs]		25(6)	34(8)	65(15)	860(193)

Table 9 UnPressurized suited Strength Data - continued


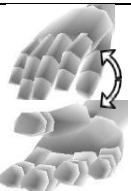
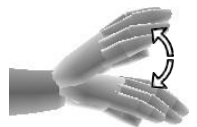


Type of Strength		Minimum Crew Operational Loads- N (lbf)			Maximum Crew Operational Loads- N (lbf)
Elbow		Elbow			
Flexion ^{2,3} [Subject moves forearm in a sagittal plane around the elbow joint]		9 (2)	13 (3)	25 (6)	243 (55)
Extension ^{2,3} [Subject moves forearm in a sagittal plane around the elbow joint]		19 (4)	25 (6)	47 (11)	174 (39)
Wrist & Hand					
Pronation ^{2,3} [Subject rotates hands and forearms medially]		116 (26)	155 (35)	290 (65)	613 (138)
Wrist Flexion ^{2,3} [Subject bends wrist in a palmar direction]		22 (5)	28 (6)	53 (12)	146 (33)
Wrist Extension ^{2,3} [Subject bends the wrist in a dorsal direction]		9 (2)	13 (3)	25 (6)	60 (13)
Pinch ¹ [Subject squeezes together the thumb and finger]		14 (3)	20 (5)	27 (6)	300(68)
Grasp ^{1,3} [Subject maintains an eccentric tight hold of an object]		243 (55)	324 (73)	486 (109)	853 (192)
Grip ¹ [Subject maintains a concentric tight hold of an object]		25 (6)	34 (8)	51 (12)	392 (88)

Table 9 UnPressurized suited Strength Data - concluded


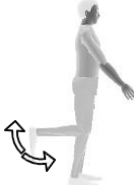
Type Of Strength		Minimum Crew Operation Loads (N(Lbf))			Maximum Crew Operational Loads (N(Lbf))
		Crit 1 Operations	Crit 2 Operations	Other Operations	
Leg		Leg			
Hip Flexion ^{2,3} [Subject moves leg in the sagittal plane around the hip joint toward the front of the body]		81 (18)	109 (25)	202 (46)	452 (102)
Knee Flexion ^{1,3} [Subject moves lower leg in a sagittal plane around the knee joint, decreasing the angle between the upper and lower leg]		37 (8)	50 (11)	97 (22)	228 (51)
Knee Extension ^{1,3} [Subject moves lower leg in a sagittal plane around the knee joint, increasing the angle between the upper and lower leg]		99 (22)	134 (30)	268 (60)	548 (123)
<p>1. Post space flight maximal measured strength decrement.</p> <p>2. Post space flight estimated strength decrement. Range is 0%-47%. Average estimated is 33%. Based on CRV Requirements Document.</p> <p>3. Suit decrement not measured directly, but estimated based on functional strength testing of other movements</p>					

Table 10 Pressurized Suited Strength Data




Type Of Strength		Minimum Crew Operation Loads (N(Lbf))			Maximum Crew Operational Loads (N(Lbf))
		Crit 1 Operations	Crit 2 Operations	Other Operations	
One Handed Pulls		One Handed Pulls			
Seated Horizontal Pull In ² [Subject in a seated position pulls towards his/her body. Unilateral/ Isometric measurement]		56(13)	74(17)	138(31)	225(51)
Seated Vertical Pull Down ² [Subject in a seated position pulls downwards. Unilateral/Isometric measurement]		63(14)	83(19)	156(35)	294(66)
One Handed Pulls		One Handed Pulls			
Seated Vertical Pull Up ² [Sitting erect with feet apart, dominant hand grasping D-ring located directly to the front above the floor, pulling upward while keeping shoulder squares & other arm in lap]		25(6)	34(8)	63(14)	378(85)

Table 10 Pressurized Suited Strength Data - continued




Type Of Strength		Minimum Crew Operation Loads (N(Lbf))			Maximum Crew Operational Loads (N(Lbf))
		Crit 1 Operations	Crit 2 Operations	Other Operations	
Standing Vertical Pull Up ² [Standing erect with feet apart, dominant hand grasping underside of D-ring located directly to the side above standing surface, pulling upward while keeping shoulders square and other arm relaxed at side]		27(6)	36(8)	67(15)	363(82)
Two Handed Pulls		Two Handed Pulls			
Standing Vertical Pull Down ² [Standing erect with feet apart, with both hands holding handle located above shoulders, pulling downward]		69(16)	91(21)	172(39)	354(80)
Standing Pull In ² [Standing erect with feet apart, with both hands holding handle located in front, pulling inward towards body]		29(7)	40(9)	74(17)	196(44)

Table 10 Pressurized Suited Strength Data - continued




Type Of Strength		Minimum Crew Operation Loads (N(Lbf))			Maximum Crew Operational Loads (N(Lbf))
		Crit 1 Operations	Crit 2 Operations	Other Operations	
Standing Vertical Pull Up ² [Standing with feet apart with a slight bend at the knees and waist, grasping a handle with both hands located directly in front and pulling upward]		45(10)	58(13)	109(25)	719(162)
Two Handed Pulls		Two Handed Pulls			
Seated Vertical Pull Up ² [Sitting erect with feet apart, grasping both sides of handle located directly to the front above the floor, pulling upward using arms and shoulders]		47(11)	63(14)	118(27)	594(134)
One Handed Push		One Handed Push			
Seated Horizontal Push Out ² [Subject in a seated position pushing away from his/her body. Unilateral/Isometric measurement]		45(10)	58(13)	109(25)	218(49)

Table 10 Pressurized Suited Strength Data - continued




Type Of Strength		Minimum Crew Operation Loads (N(Lbf))			Maximum Crew Operational Loads (N(Lbf))
		Crit 1 Operations	Crit 2 Operations	Other Operations	
Seated Vertical Push Up ² [Subject in a seated position pushing upward in a vertical direction. Unilateral/Isometric measurement]		34(8)	43(10)	80(18)	140(32)
Two Handed Push		Two Handed Push			
Standing Vertical Push Down ² [Standing with feet apart with a slight bend at the knees and waist, grasping a handle with both hands located directly in front and pushing downwards]		51(12)	67(15)	127(29)	263(59)
Standing Horizontal Push Out ¹ [Standing erect with feet apart, with both hands holding handle located in front, pushing out away from body]		31(7)	43(10)	83(19)	298(67)

Table 10 Pressurized Suited Strength Data - continued


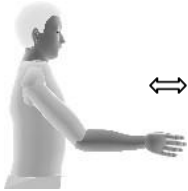
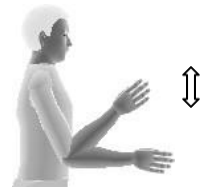
Type Of Strength		Minimum Crew Operation Loads (N(Lbf))			Maximum Crew Operational Loads (N(Lbf))
		Crit 1 Operations	Crit 2 Operations	Other Operations	
Standing Vertical Push Up ² [Standing erect with feet apart, grasping from below, both sides of handle located directly in front above standing surface. Pushing upwards using arms and shoulders]		38(9)	49(11)	94(21)	547(123)
Arm		Arm			
Arm Pull ² [Subject pulls handle forward and backward]		22(5)	29(7)	54 (12)	125 (28)
Arm Push ² [Subject pushes handle forward and backward]		20(5)	27(6)	49 (11)	111 (25)
Arm Up ² [Subject moves handle up]		9(2)	11(3)	20 (5)	54(12)

Table 10 Pressurized Suited Strength Data - continued

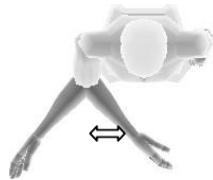

Type Of Strength		Minimum Crew Operation Loads (N(Lbf))			Maximum Crew Operational Loads (N(Lbf))
		Crit 1 Operations	Crit 2 Operations	Other Operations	
Arm Down ² [Subject moves handle down]		11(3)	16(4)	29(7)	58(13)
Arm In ² [Subject moves handle medially]		11(3)	16(4)	29(7)	49 (11)
Arm Out ² [Subject moves handle laterally]		7(2)	9(2)	18 (4)	38 (9)
Lifting		Lifting			
Lifting Strength ² [Standing with feet apart with a slight bend at the knees and waist, grasping a handle with both hands located directly in front and pulling upward using primarily arms and shoulders, and legs]		18(4)	25(6)	47(11)	614(138)

Table 10 Pressurized Suited Strength Data - continued

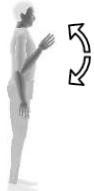

Type Of Strength		Minimum Crew Operation Loads (N(Lbf))			Maximum Crew Operational Loads (N(Lbf))
		Crit 1 Operations	Crit 2 Operations	Other Operations	
Elbow		Elbow			
Flexion ^{2,3} [Subject moves forearm in a sagittal plane around the elbow joint]		7 (2)	9 (2)	18 (4)	174 (39)
Extension ^{2,3} [Subject moves forearm in a sagittal plane around the elbow joint]		14 (3)	18 (4)	34 (8)	125 (28)
Pronation ^{2,3} [Subject rotates hands and forearms medially]		83 (19)	111 (25)	207 (47)	438 (99)
Supination ^{2,3} [Subject rotates hands and forearms laterally]		80 (18)	107 (24)	203 (46)	381 (86)

Table 10 Pressurized Suited Strength Data - continued




Type Of Strength		Minimum Crew Operation Loads (N(Lbf))			Maximum Crew Operational Loads (N(Lbf))
		Crit 1 Operations	Crit 2 Operations	Other Operations	
Wrist & Hand		Wrist & Hand			
Wrist Flexion ^{2,3} [Subject bends wrist in a palmar direction]		19 (4)	25 (6)	37 (8)	101 (23)
Wrist Extension ^{2,3} [Subject bends the wrist in a dorsal direction]		7 (2)	9 (2)	14 (3)	33 (7)
Pinch ¹ [Subject squeezes together the thumb and finger]		14 (3)	20 (5)	27 (6)	300(68)
Grasp ^{1,3} [Subject maintains an eccentric tight hold of an object]		174 (39)	232 (52)	347 (78)	610 (137)
Grip ¹ [Subject maintains a concentric tight hold of an object]		25 (6)	34 (8)	51 (12)	392 (88)

Table 10 Pressurized suited Strength Data - continued


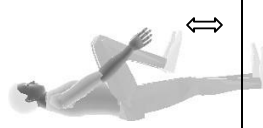

Type Of Strength		Minimum Crew Operation Loads (N(Lbf))			Maximum Crew Operational Loads (N(Lbf))
		Crit 1 Operations	Crit 2 Operations	Other Operations	
Leg		Leg			
Hip Flexion ^{2,3} [Subject moves leg in the sagittal plane around the hip joint toward the front of the body]		58 (13)	78 (18)	145 (33)	323 (73)
Hip Extension ^{2,3} [Subject moves leg in a sagittal plane around the hip joint toward the back of the body]		96 (22)	127 (29)	238 (54)	329 (74)
Leg Press ^{1,3} [Subject pushes a weight away from them using their legs]		309 (70)	414 (93)	776 (175)	1292 (291)

Table 10 Pressurized suited Strength Data - concluded

Type Of Strength		Minimum Crew Operation Loads (N(Lbf))			Maximum Crew Operational Loads (N(Lbf))
		Crit 1 Operations	Crit 2 Operations	Other Operations	
Knee Flexion ^{1,3} [Subject moves lower leg in a sagittal plane around the knee joint]		27 (6)	36 (8)	69 (16)	163 (37)
Knee Extension ¹ [Subject moves lower leg in a sagittal plane around the knee joint]		71 (16)	96 (22)	192 (43)	392 (88)

- . 1. Post space flight maximal measured strength decrement.
- . 2. Post space flight estimated strength decrement. Range is 0%-47%. Average estimated is 33%. Based on CRV Requirements Document.
- . 3. Suit decrement not measured directly, but estimated based on functional strength testing of other movements

Basic Optical Theory Applied to Windows

Light Wave Propagation

Light travels as an electromagnetic wave. Throw a stone into a pond, spherical waves radiate from the point of entry. Like this example, a point source (a star) radiates spherical (electromagnetic) waves in all directions (Figure 1). A wavefront is defined as a surface joining all adjacent points on a wave that have the same phase. The path of a point on the wavefront is called a ray. If we trace the path of a hypothetical point on the surface of a wavefront as it moves through space, the point progresses as a straight line. A light ray is a line that runs perpendicular to the wavefront and in the direction that the wavefront is traveling. They are used extensively in geometrical optics.

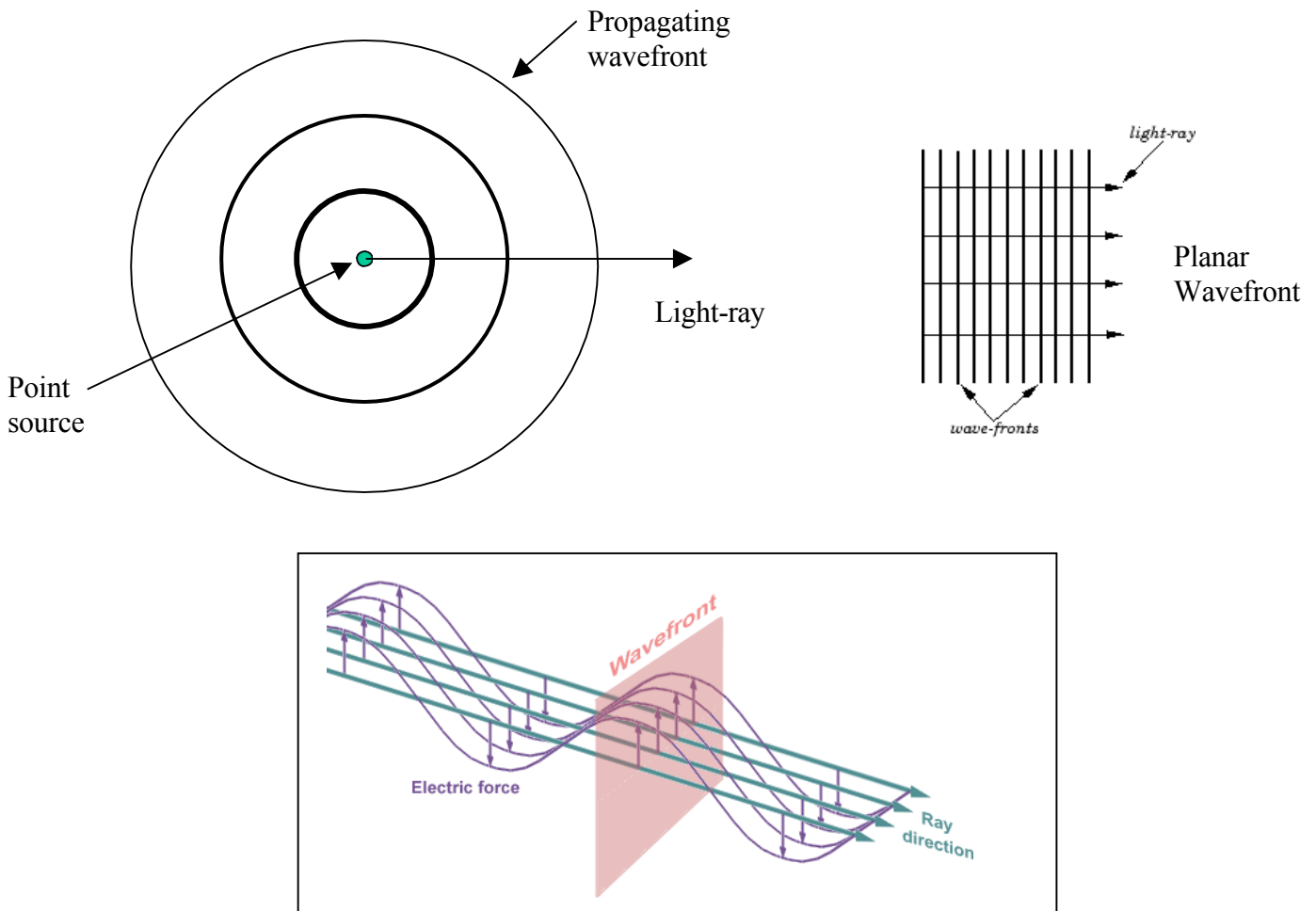


Figure 1: Light waves radiating from a point source

As the wavefront of light travels far from the point source, the curvature of the once spherical waves becomes very small such that the waves can be considered planar (Figure 1). When one sees a star, one is collecting only a very small portion of the light that was emanated from that star (since light is being radiated in all directions). A telescope collects more light from a star because it has a larger aperture than when viewed with the naked eye (Figure 2). Every part of the wavefront contains information about the whole object whether you collect it with a large aperture, or a small aperture, optical system. A larger aperture system produces a brighter and more detailed image because more light is collected.

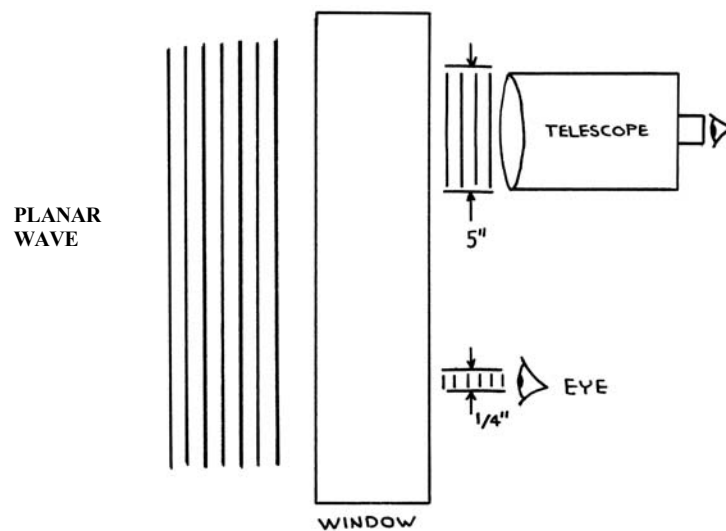


Figure 2: Observing light with different size apertures

Snell's Law

When a planar wavefront is incident upon a surface separating two mediums, part of the wavefront will be reflected, and part of the wavefront will be transmitted (Figure 3). The transmitted wavefront will be refracted in the amount which is described by Snell's Law.

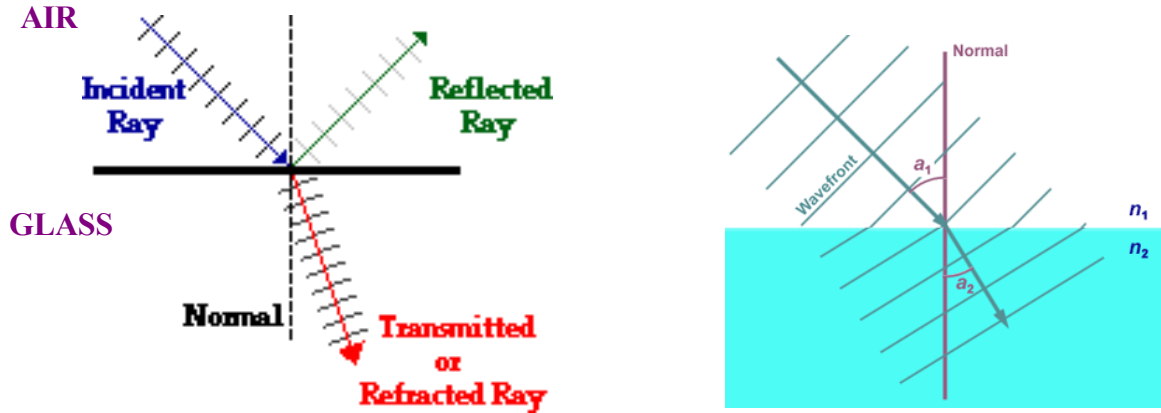


Figure 3: Refraction and Reflection of a Planar Wave at a material boundary.

For an air –glass interface, the light refracts towards the normal of the surface. The law of refraction or Snell’s Law states that the amount the planar wave is refracted, is dependent on the index of refraction (n_1 and n_2) of each medium, and the angle of incidence of the incident light (θ_i). The angle θ_r is the resulting angle to the normal after refraction.

$$\text{Snell's Law: } n_1 \sin\theta_i = n_2 \sin\theta_r$$

The index of refraction is a fundamental property of a material and is defined as the ratio of the speed of light in vacuum with the speed of light in the material. For air and vacuum, $n = 1$. For water, $n = 1.33$. The index of refraction for glass varies with type but is usually between 1.45 and 1.6. The denser the material, the more light will refract (Figure 4).

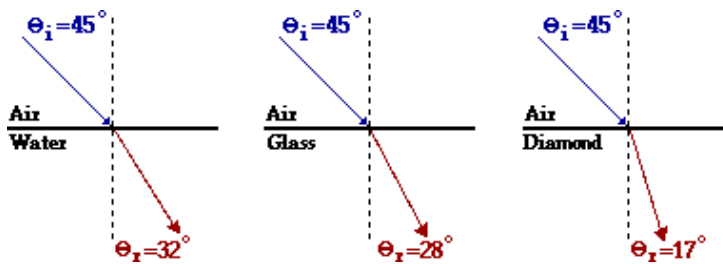


Figure 4: Refraction for different materials

When light passes through a window at an angle, it refracts when entering the glass (towards the normal), and then refracts again (away from the normal) when it re-emerges into air (Figure 5). The light returns to traveling in the same direction it had before it entered the glass. Maintaining ray direction is very important as will be seen later.

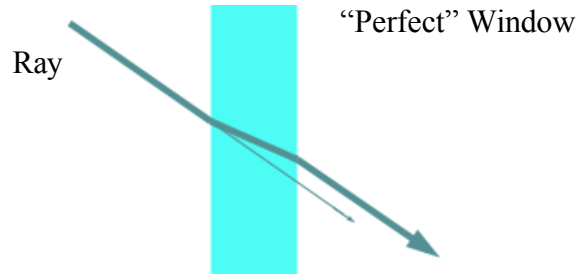


Figure 5: Light traveling through a window emerges traveling in the same direction

Image Formation

The basic operation of an optical system is to collect energy from a wavefront radiating from an object (like a point source) and refocusing it into an image of the object. Every point in object space will be represented in image space, and hence the image looks like the object. To understand how a lens produces an image, a very simple example is given. A camera lens usually contains several lenses, but the same basic theory still applies. When a planar wavefront illuminates a lens such that the ray direction is parallel to the lens axis, the light will be focused at the focal point of the lens (Figure 6).

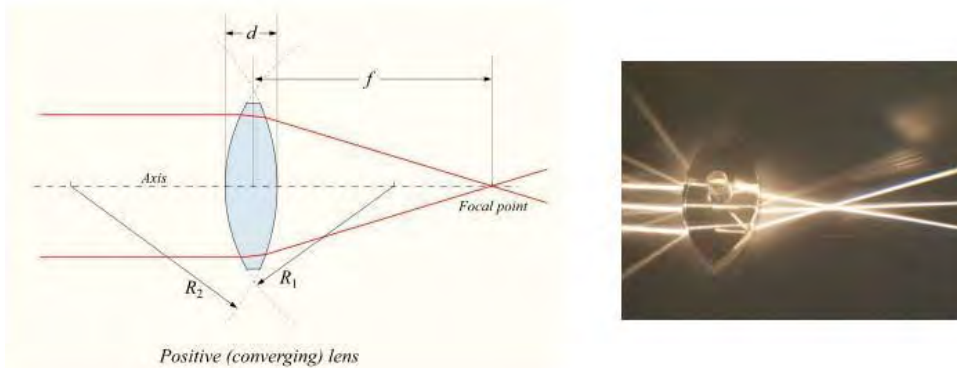


Figure 6: A positive lens focusing light at its focal point.

The thin lens formula specifies the distance behind the lens (i) where the image will be formed which depends on the distance of the object (o) and the focal length of the lens (f). For an object that is far away (at infinity), the image is found at the focal length of the lens.

Thin lens formula:
$$\frac{1}{o} + \frac{1}{i} = \frac{1}{f}$$

For an object that is not located along the optical axis, it will be focused on the focal plane (Figure 7). The focal plane is the imaging plane perpendicular to the optical axis that includes the imaging point (an example is the film plane of a camera).

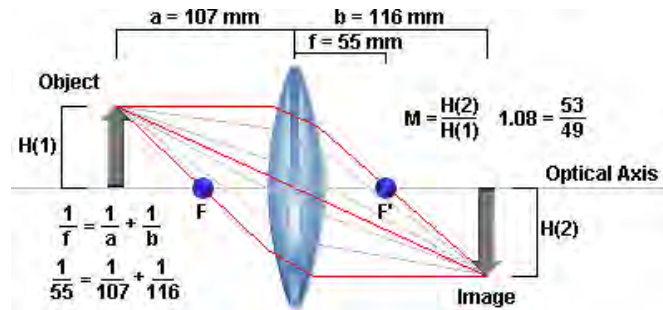


Figure 7: Imaging an extended object

Imaging Extended Sources

An extended source (a tree, car, most everything in this world) can be regarded as an array of millions of point sources. So when an astronaut views the Earth from the Orbiter, many overlapping point sources of different colors and brightness's are each emitting spherical waves that when they reach the Orbiter, are many planar waves coming from many directions (Figure 8).

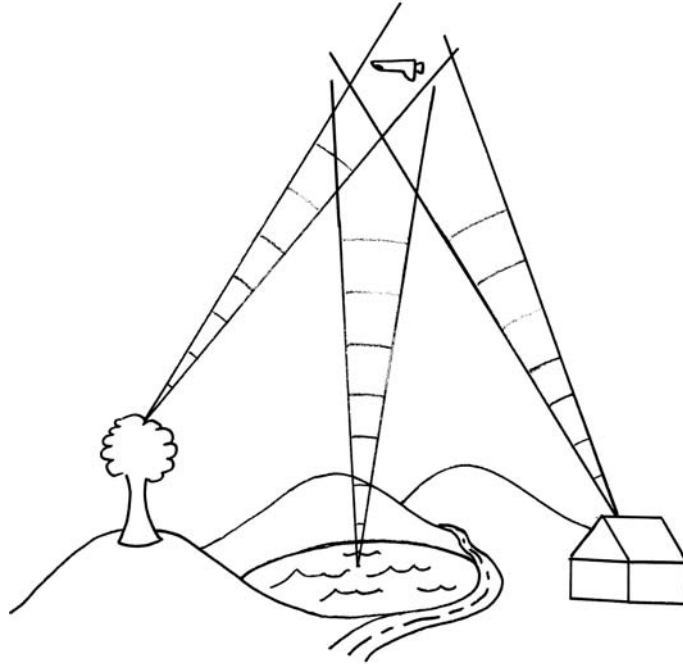


Figure 8: A scene of extended sources

The amount of detail recorded by an optical system from an extended scene depends on the ability of the optical system to map each point of each object into the appropriate place in the image plane. As discussed earlier, only a small part of each one of the spherical waves will reach the optical system. Furthermore, energy from each one of the waves (now planar since the object is far away) will traverse every part of the aperture of the receiving optical instrument. The optical instrument then must collect the energy of these millions of overlapping waves and map each one of these waves to the correct place in the image plane. One small part of each wave will enter the center of the aperture, whereas another part of each wave will enter at different places along the edge of the aperture, and everywhere in between (Figure 9).

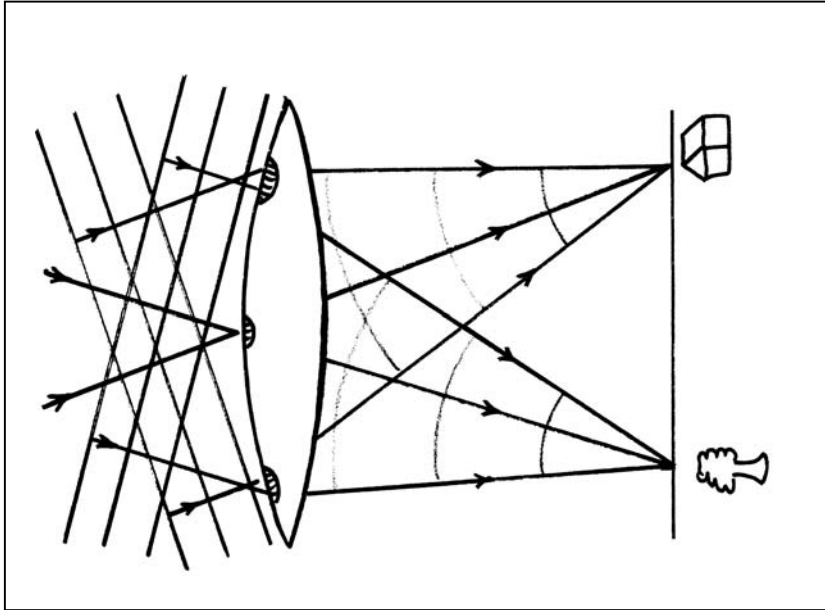


Figure 9: An extended scene being imaged

Notice that the *direction* of the light-rays (perpendicular to the wavefront) determines where on the image plane the image will appear.

Wavefront Error

Wavefront error occurs when the planar waves from an object are distorted such that the individual wavefront is no longer all in phase. This occurs when different parts of the wavefront travel different optical path lengths. Optical path length (OPL) refers to the path that the light travels and is described as follows:

$$\text{OPL} = nt$$

where n is the index of refraction and t is the physical length of the path.

In an ideal window, a planar wave will pass through the window such that the optical path length at each point on the window is the same, and the wavefront retains the same phase.

In an imperfect window, the wavefront is distorted (the phase is not maintained). The wavefront can be distorted because of surface errors (the window is not 'flat') or by material inhomogeneities (the index of refraction varies) (Figure 10).

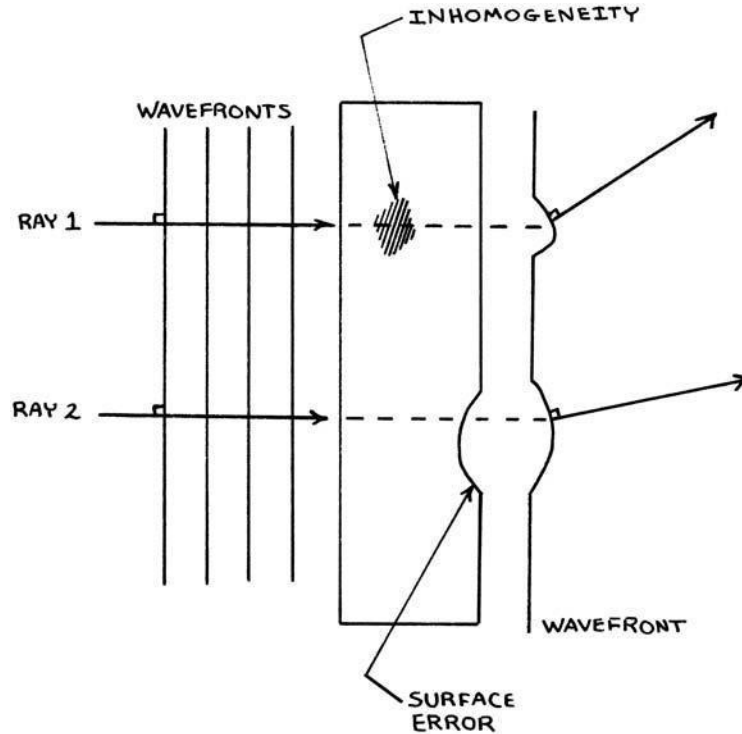


Figure 10: An imperfect window distorts the wavefront

Notice that the two rays that were once traveling in one direction before transmitting through the window are now traveling in different directions (they remain perpendicular to that part of the wavefront). As discussed in the previous section, the *direction* of the light ray determines where the light will be imaged on the image plane by an optical system. Hence, for that section of the wavefront (that amount of energy), when imaged by an optical system, will be focused into the wrong location in the image plane. Each small area on the wavefront represents a copy of the entire object and is imaged as a whole on the image plane. Imaging a large area of the wavefront results in many overlapping copies of the object focused on to the image plane (Figure 11). If too much energy is focused in the wrong place, the image will look blurry. The degree for which the image is degraded depends on the amount of energy diverted from its intended place. This diversion of energy is collectively known as optical aberrations.

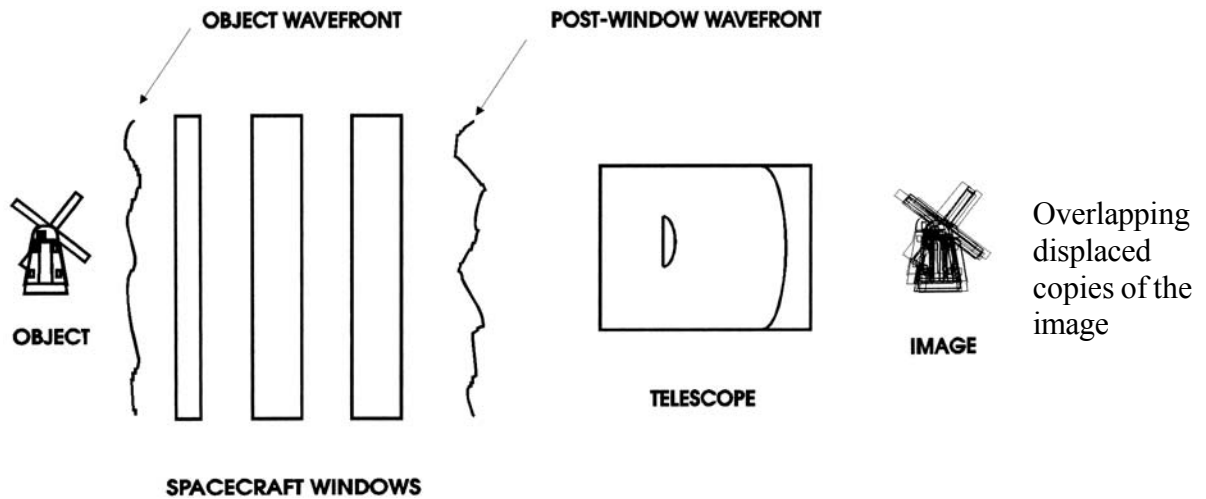


Figure 11: A distorted wavefront results in the diversion of energy and blurriness in the image

Wavefront error is aperture dependent. The more area of a wavefront that is imaged, the more likely that some of the wavefront will be distorted, resulting in energy diversion in the image. Large aperture systems will provide higher resolution, but only if the wavefront quality is sufficient. If there is too much diversion of energy, all of the small detail will be washed out (Figure 12). One would be better off using a smaller aperture system (but lower resolution) because the wavefront quality will likely be better over the smaller area.

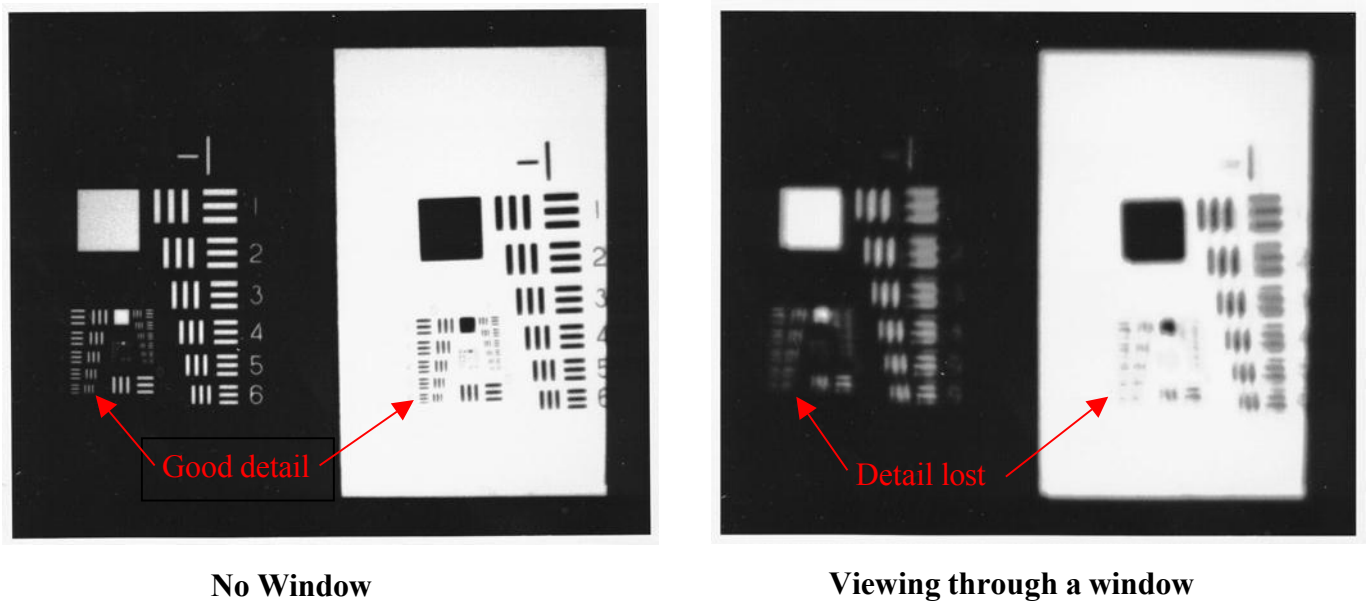


Figure 12: Washing out of detail when imaging an Air Force tribar target with a large aperture system due to window induced wavefront error

Wavefront error is described as the total optical path difference induced into the wavefront with respect to the wavelength of light (usually described with respect to the HeNe laser wavelength of 632.8 nm) (Figure 13). So a $1/2$ wave of wavefront error indicates that there is a 316 nm difference between the path traveled by one part of the wavefront, and another part of the wavefront, for a given aperture (wavefront error is aperture dependent).

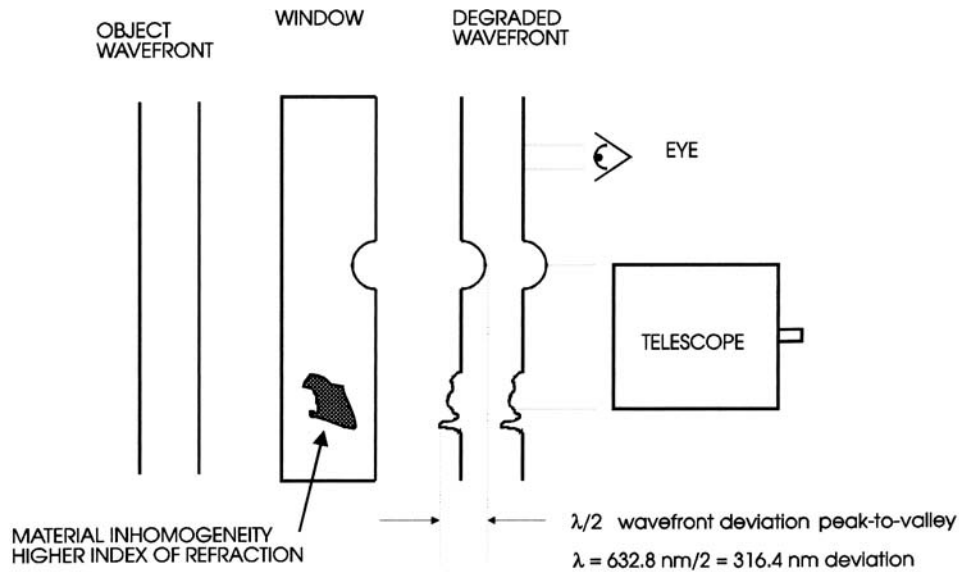


Figure 13: Measuring wavefront error and aperture dependence

The optical path length difference may be due to a surface error that makes the window 316 nm less thick at a particular point, or it could be an index of refraction variation that changes the optical path length by that amount. Optical path length differences, and therefore wavefront error, can be induced by any material, not just glass. Plastics, adhesives, and laminates are problematic because they cannot be polished flat, and the index of refraction of the materials is not well controlled.

Rayleigh Limit

Wavefront error degrades image quality. Hence, how much error is too much? There is a rule of thumb for smaller aperture systems (standard cameras, binoculars etc) that says that if the amount of optical aberrations is maintained below the Rayleigh Limit, that most systems will perform well. The Rayleigh Limit refers to an optical path difference of 1/4 wave. The rule of thumb originated from a famous paper by A. Marechal titled "Etude des effets combines de la diffraction et des aberrations geometriques sur l'image d'un point lumineux", Rev. Opt. 26:257 (1947). The Rayleigh Limit is discussed in many textbooks including "Modern Optical Engineering" by W. Smith. In reference to the Rayleigh Limit, Smith states the following:

"...it is apparent that an amount of aberration corresponding to one Rayleigh Limit does cause a small but appreciable change in the characteristic of the image. For most systems, however one may assume if the aberrations are

DRAFT

reduced to the Rayleigh Limit, the performance will be first class and that it will take a determined investigator a considerable amount of effort to detect the resultant difference in performance. An occasional system does require correction to a fraction of the Rayleigh Limit...

The systems that require better correction than the Rayleigh Limit are telescopes and microscopes.

Optical Design Guidelines For Good Windows

A spacecraft window port is the first optical element to any optical system that is used in the crew cabin. Depending on the optical system used, the window can have a serious effect on the quality of the imagery collected. The optical quality of the window port is as important as any lens in the camera using the window.

There are two sections to this document. The first section addresses the fundamentals of spacecraft window optical design by answering key questions. The second section provides “rule of thumb” guidelines to window port design.

Theory Questions

A good window is optically uniform over the aperture diameter that it will be used. The optical path length is the same across the aperture size.

Aperture diameter is very important. What is the aperture diameter for typical cameras and the eye?

The aperture diameter of a camera is dependent on the focal length and $f/\#$. Aperture Size = focal length/ $f/\#$.

Example

Focal length = 400 mm (the lens the inspection folks like)

$f/\# = 4$

Aperture Size = 400 mm / 4 = 100 mm

Aperture

F/2.8



F/8



F/11



Table: Aperture Sizes For Different Cameras

	Lens Focal Length	Aperture Size at different $f/\#$ s	Comments
The Eye (pupil size)	17 mm	2 mm daytime 8 mm dark adapted	Pupil size of the eye is usually very small
Cannon Power Shot G6 “point and shoot”	7.2 mm	$f/2.8 - 2.6$ mm $f/8 - 0.9$ mm	Point and shoot cameras have small apertures
Nikon DCS 760	50 mm	$f/2 - 25$ mm $f/8 - 6.25$ mm	
	180 mm	$f/2.8 - 64$ mm $f/8 - 22.5$ mm	
	400 mm	$f/2.8 - 142$ mm $f/4 - 100$ mm $f/5.6 - 71$ mm $f/8 - 50$ mm	The 400 mm lens is the favorite lens for inspection tasks.

The less light there is, the more the aperture size needs to be increased to collect more light, hence, a lower $f/\#$ must be used.

What does wavefront refer to?

Sound travels as acoustic waves, energy in water travels as water waves, light travels as electromagnetic waves. A wavefront is defined as a surface joining all adjacent points on a wave that have the same phase. So in the water example, a wave crashing on a beach would be one single wavefront, with the next wave being the next wavefront. The distance between those waves is the wavelength.

What does the index of refraction of a material refer to?

The index of refraction (n) is a material property. It refers to the ratio of how light travels in vacuum to how it travels in a material. Simplistically (but not quite correct) it is the ratio of the difference of the velocity of light in vacuum to the velocity in the material (light travels slower in a material). The larger the index value, the “denser” the material and the more it will bend light entering it. For air and vacuum, $n = 1$. For water, $n = 1.33$. The index of refraction for glass varies with type but is usually between 1.45 and 1.6. For sapphire $n = 1.76$, and for diamond $n = 2.419$. Index of refraction does vary with wavelength and temperature.

The optical path length through a window needs to be uniform across the lens aperture size to achieve good imagery. What is the optical path length?

The optical path length is the path that the light collected by the lens travels through the window prior to entering the lens. It is a product of the index of refraction of the material, and the physical thickness of the panes.

The optical path length (OPL) is: $OPL = nt$

n – is the index of refraction of the material

t – is the physical length the light travels

If parts of a wavefront travel different optical path lengths, then the entire wavefront is not in phase. In the water wave example, it would be like a wave on the beach crashing at slightly different times as seen in the image below. The middle part of the wave has been delayed (probably because of greater friction on the beach floor). In optics, this type of phase delay in one part of the wavefront can make images look blurry.



Phase Difference along the wavefront

Figure: Non-uniform wavefront

What causes a window to be optically nonuniform?

A window is optically nonuniform for only two reasons:

1. The thickness of the pane varies
2. The index of refraction varies across the pane

The index of refraction can vary across the pane for a number of reasons:

- f* The material itself is inhomogeneous (the index of refraction is different over different parts of the pane)
- f* There are large temperature gradients (index of refraction in a material is a function of temperature)
- f* There is significant stress that varies across the pane (index of refraction changes as a function of stress).

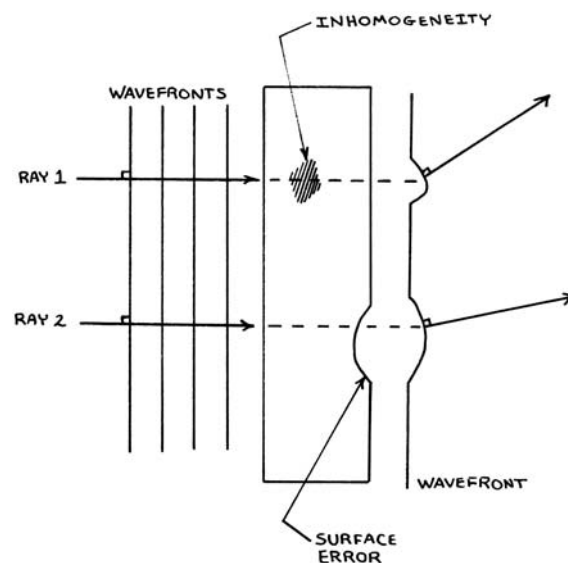


Figure: Material and surface imperfections cause phase changes to the wavefront

A very good index of refraction homogeneity is one part per million. A significant index of refraction variation would be 10 parts per million. Hence, if the index of refraction varies between 1.500000 and 1.500010, that's bad. That would equate to an optical path different in a one inch pane of: $OPD = (1.50001 - 1.50000) * (25.4\text{mm}) = \lambda/2.5$.

In addition, using tempered materials that cause a non-uniform stress distribution in the pane will lead to a non-uniform index of refraction. For example, the area near the tong marks on the Orbiter overhead windows is worse optically than the areas far from the tong marks probably due to stress.

Why is aperture diameter important?

The aperture diameter defines the area of the window that must be uniform. That means that the entire window need not be uniform, but just uniform over sub-sampled areas the size of the aperture that will be used. Uniformity over a small aperture diameter (1 inch or less) is much easier to achieve than over a very large diameter (6 inches). A wavefront requirement always includes the aperture for which it is to be applied. The aperture size is the reason a window can "look" fine, but cause poor image quality in cameras. The eye has an aperture of 2 mm, so the window need only be optically uniform over a 2 mm aperture. A camera may have an aperture of 150 mm, hence a window area 5000 times larger needs to be uniform.

How much wavefront variation is a problem?

The amount of variation permissible depends on the instruments (and the apertures of those instruments) that will be used through the window. The wavefront requirement is the single most important requirement to ensure that the required optical uniformity is met. An ideal window would induce no errors into a transmitting wavefront (i.e. the light would travel the same optical path length through all parts of the window). However, since there is no such thing, the next best thing to use is the Rayleigh Limit. The Rayleigh Limit addresses how much wavefront error can be introduced by a window, but not affect the image quality of a very good optical system viewing through it. The Rayleigh Limit allows for not more than 1/4 wave optical path difference (OPD) with the reference wavelength typically being 632.8 nm. If the total optical aberrations are limited to less than one Rayleigh Limit, then smaller aperture systems (standard cameras, binoculars etc) will perform well. The wavefront requirements for Category B, C, and D windows rely on the Rayleigh Limit. For larger aperture systems such as for telescopes and other high performance systems, the Rayleigh Limit is not sufficient to ensure that noticeable degradation is not introduced by the window. Hence, Category A windows require an OPD of no more than $\lambda/10$ wave because telescopes are corrected to at least $\lambda/8$.

What does 1/4 wave or $\lambda/4$ mean?

Wavefront error is given in fractions of a wavelength. The wavelength of light used in most interferometers is 632.8 nanometers (nm) which is the wavelength of a helium-neon laser (also used in many laser pointers, its red in color). So when the reference wavelength

is $\lambda = 632.8 \text{ nm}$, a wavefront error of $\lambda/4$ means that $632.8 \text{ nm} / 4 = 158 \text{ nm}$ of error exists in the optical path length. If all of the error come from a surface error, that means that one part of the window is 158 nm (0.000006 inches) thicker or thinner than another part of the window. That is, one part of the wavefront traveled 158 nm more of glass than another part of the wavefront. The figure shows an example of a $\lambda/2$ error. One part of the wavefront traveled an optical path length that was 316 nm different than another part of the wavefront.

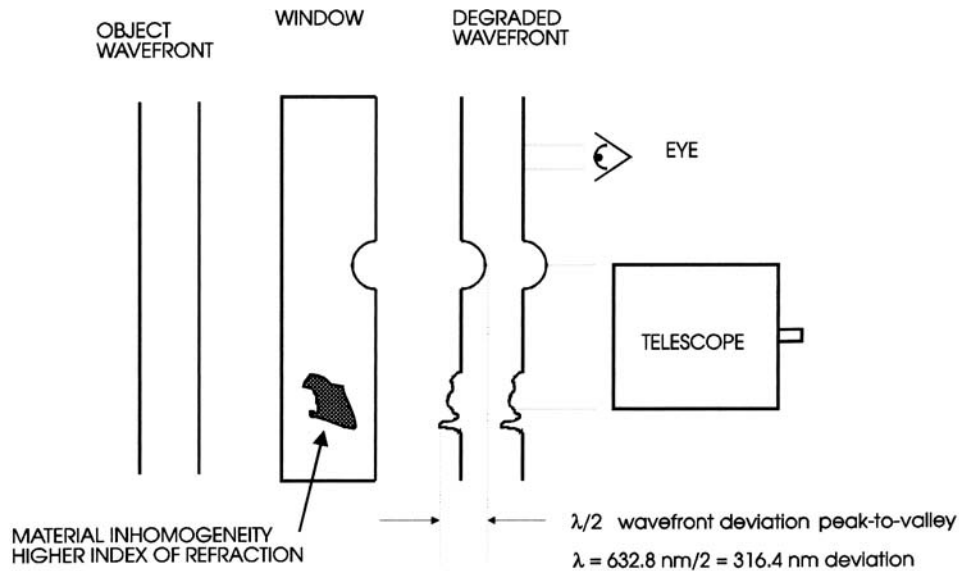


Figure: Different parts of the wavefront travel different optical paths because of material and surface imperfections

What measures wavefront, and how long does it take to measure wavefront?

Interferometers measure wavefront. Every optics company has multiple interferometers (Corning, Zygo, etc.) as do most companies that have optics departments (including Aerospace). MSFC and Goddard have lots of them. Once the window ports are positioned in the instrument, the measurements can be performed in minutes. Below is the photo of the Destiny windows being tested at Zygo.

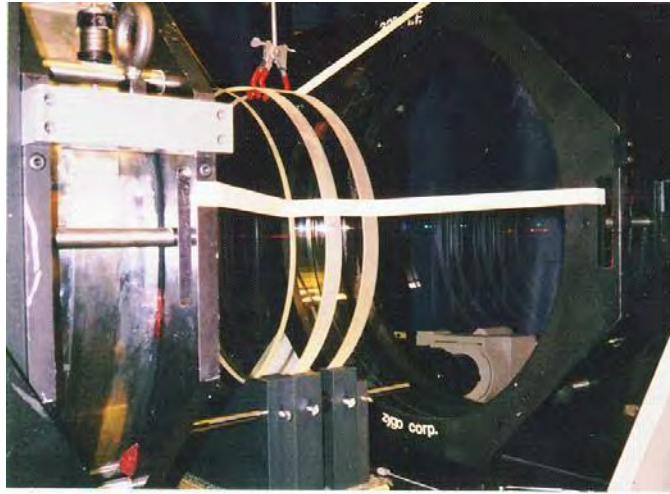


Figure: Destiny Windows Tested By Interferometer

After the data is collected, the interferometer software automatically provides wavefront error values and a wavefront map that shows the peaks and valleys over the entire window. Below is the typical output which shows the wavefront values over different parts of the window for a single aperture size (i.e. the window is sampled over different 6 inch diameter areas to see the wavefront error does not exceed the requirements).

Total Wavefront:
 $0.082 = \lambda/12$

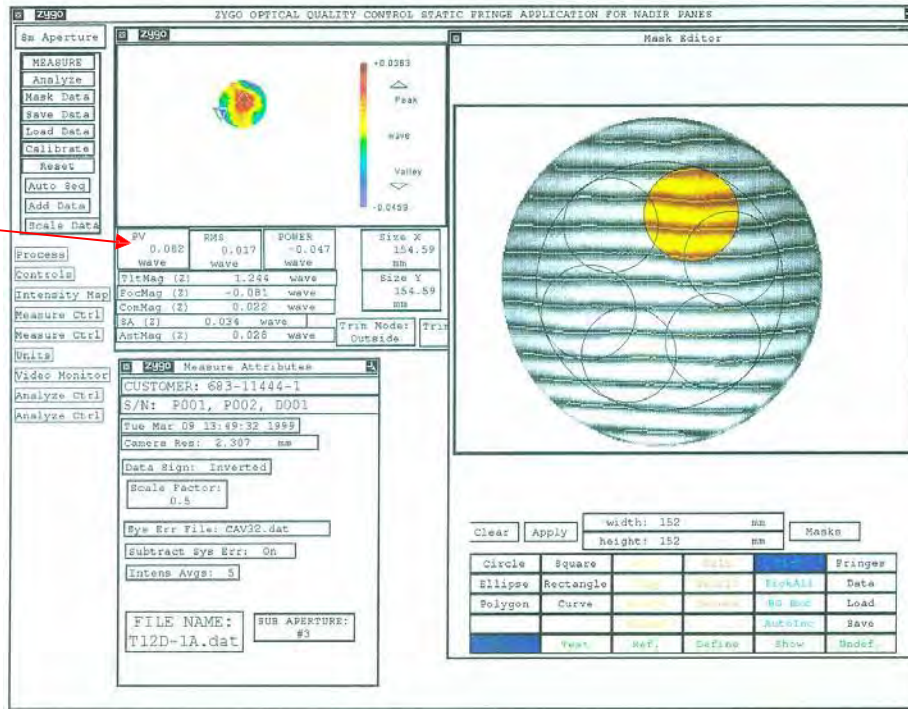


Figure: Interferometer Output

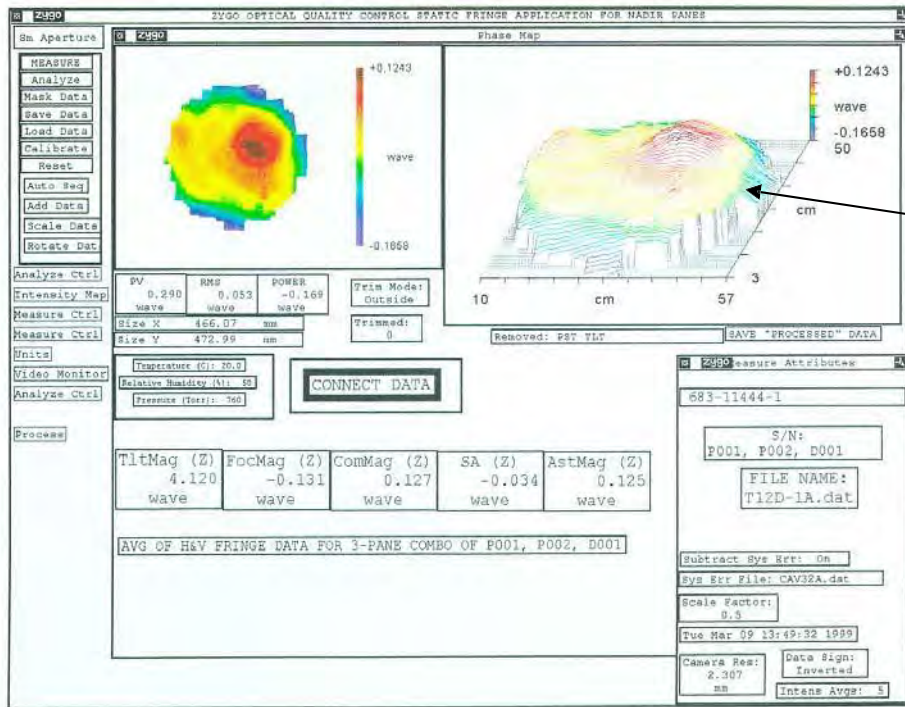


Figure: Wavefront Map

Design Guidelines

What are things that don't affect wavefront quality (i.e. optical uniformity)?

- Pane parallelism of a multi-pane window port for the most part does not affect image quality. It is not necessary to position panes exactly right with respect to each other.
- Pane wedge, which is the angle the two surfaces make with respect to each other, does not affect image quality unless the angle is severe (something really obvious like 30 degrees). There are other issues with wedge which is why there are requirements, but it typically doesn't affect image quality.
- The medium between the panes, whether air or the vacuum of space, does not affect image quality unless there is moisture which would cause fogging.
- Optical coatings do not affect wavefront quality unless they are really thick and applied really non-uniformly. Typical anti-reflection coatings usually cause no problems.
- Pressure which causes an internal pane to bend slightly on a window port is typically not a problem unless possibly the window pane is really thin, or there is a great deal of stress. The wavefront error caused by pressure on the Destiny window was $\lambda/100$, not very much.

What are some good optical rules of thumb when designing windows?

- Use optically uniform materials that can be polished so the surfaces are very flat. Glass or other ceramics work best because they can be polished, and the index of refraction is well controlled.
- Avoid laminates, adhesives, and plastics. These materials don't have well controlled index of refraction values, and the thicknesses are hard to control to 0.000006 inches (necessary to meet a $\frac{1}{4}$ wave requirement). There may be some optical grade plastics that might be good enough for covers, but without testing, it's not clear.
- Thinner windows are typically better in that there is less material that needs to be homogeneous. Thinner windows are cheaper.
- Avoid tempered windows because the induced stress in the window port is typically non-uniform, and hence that leads to non-uniformity in the material index of refraction. Plastics can also have significant stress present.
- Wavefront is the most important requirement to ensure good image quality. Do not compromise on wavefront quality even if it means giving up other requirements (which shouldn't be necessary). The contractor should not be allowed to proceed with any design for which they can't show that the materials will meet wavefront quality.

- Make sure that the materials near the window panes are not going to outgas on them. Seals, especially silicone seals (even baked out) can be a problem in an enclosed volume. Some paints and all adhesives (even small amounts applied to bolt heads) should not be applied near any window.
- Ensure the materials selected for the window ports will not darken quickly from exposure to radiation and the ultraviolet. Fused silica has excellent resistance, standard plastics do not (they will turn yellow or brown).
- Shutters that can protect windows when not in use should be encouraged. Even a small iris type shutter would protect them from contamination and darkening from ultraviolet exposure.
- Window frame components should be black to reduce scattered light.
- Avoid putting non-durable coatings on surfaces exposed to the crew, unless the panes can be changed often. A removable protective pane that supports some photography is the best way that windows can be protected.
- Providing anti-reflection coatings on every surface that one can be applied is important. Reflection losses depend on the index of refraction value of the pane. The larger the index of refraction of the material, the larger the reflection loss. Reflection losses off glass are typically 4% per surface, so each pane that is not coated does not transmit 8% of the incident light. Sapphire and diamond have much larger losses because of their large index of refraction values.
- In speaking with some plastic optics experts, plastic windows are not going to optically perform as well as glass windows over large apertures. However, if an optical grade plastic is used (available from GE and perhaps some Japanese manufacturers), the optical performance will be better than found in a standard plastic material. The key is to anneal the material to reduce stress. One expert thought that one wave per inch is about the best that can be achieved. This would be okay for a protective cover that can be removed. Testing is the only way to determine for sure what is available. Since stress in plastic can be a major contributor to optical errors, plastic windows need to be mounted without induced stress. Warping and clamping a plastic window will induce optical errors and therefore needs to be avoided.
- If a laminate needs to be used, consider a design that only uses laminate materials at the edges so that optical path homogeneity can be preserved through the middle of the window port. Be sure to use antireflection coatings to minimize reflection losses through the middle of the window port.

Appendix D

OPTICAL PERFORMANCE REQUIREMENTS FOR WINDOWS IN HUMAN SPACE FLIGHT APPLICATIONS

For research and technical assistance contact the authors:

Mario Runco, Jr. (Astronaut: STS-44, 54, & 77)
Lead, Spacecraft Window Optics and Utilization
Human Exploration Science Office (KX)
Astromaterials Research and Exploration Sciences
Directorate (KA) and
Habitability and Human Factors Branch (SF3)
Habitability and Environmental Factors Division (SF)
Space and Life Sciences Directorate (SA)

Karen P. Scott, Ph.D., (The University of Arizona,
Optical Sciences Center, 1998)
Senior Engineering Specialist

Lyndon B. Johnson Space
Center
2101 NASA Road 1
Houston, Texas 77058-3696
mario.runco-1@nasa.gov
(281) 244-8882

The Aerospace Corporation
Author of over 30 scientific
and technical papers on
spacecraft window design
karen.p.scott@aero.org
(281) 283-6457

Valuable assistance and support in helping to prepare this document is gratefully acknowledged from:

The Late David Amsbury (JSC)
Janis Connolly (JSC-SF3)
Dean B. Eppler (SAIC-JSC-ZX)
Kamlesh P. Lulla (JSC-KX)
Gary A. Fleming (LRC)
Howard A. Wagner (JSC)
Charles Allton (JSC)

Susan K. Runco (JSC-KX)
David Warren (Aerospace Corp.)
Stephen K. Wilcken (The Boeing Corp.)
W. Thomas Morrow (JSC)
Mary J. Taylor (Bastion Technologies-JSC)
Ricardo J. Villareal (JSC)
Paul March (Barrios Technologies-JSC)

Section 1 lists the specific optical performance requirements levied on spacecraft windows.

Section 2 lists the corresponding verification methodologies for the above optical performance requirements.

Section 3 lists the verification methodologies for the specifications in Chapter 8 of this handbook. The “3.0” paragraph numbering in this appendix corresponds to the “8.0” paragraph numbering in Chapter 8.

The Glossary at the end of this appendix contains a list of Optical Terms, Definitions, and Conventions

Order of Precedence:

In the event of a conflict between the text of this specification and an applicable document cited herein, the text of this specification takes precedence. All specifications, standards, exhibits, drawings or other documents that are invoked as "applicable" in this specification are incorporated as cited.

Applicable Documents

ASTM D1003, Procedure A	2000 June 10	<i>Standard Test Method for Haze and Luminous Transmittance of Transparent Plastics</i>
ASTM D1044	2005 November 01	<i>Standard Test Method for Resistance of Transparent Plastics to Surface Abrasion</i>
ASTM E1559	2003 May 10	<i>Standard Test Method for Contamination Outgassing Characteristics of Spacecraft Materials</i>
ISO 10110-7	1996	<i>Optics and optical instruments - Preparation of drawings for optical elements and systems- Part 7: Surface imperfection tolerances</i>
MIL-C-48497	1980 September 08	<i>Coating, Single or Multilayer, Interference: Durability Requirements for</i>
MIL-E-12397B	1954 November 18	<i>Eraser, Rubber Pumice (For Testing Coated Optical Elements)</i>
MIL-G-174	1986 December 05	<i>Glass, Optical</i>
MIL-PRF-13830B	1997 January 9	<i>Optical Components for Fire Control Instruments; General Specification Governing the Manufacture, Assembly, and Inspection of</i>
<i>NASA-STD-6016</i>	<i>2006 September 11</i>	<i>Standard Materials and Processes Requirements for Spacecraft</i>

Reference Documents

Document Number /	Revision/	<i>Document Title</i>
Source	Release Date	
U.S. Lab Window Operational Constraints	Final 2005	<i>ISS Generic Operational Flight Rules Volume B, Section B2-19</i>
Koontz, K.L. et al ISS Subsystem Environments Team	22.Apr.05	<i>STS-114 DTO-848 Non-Oxide Adhesive Experiment (NOAX) Contamination (Internal & External) Risk Assessment (SORR)</i>
Scott, K.P. et al	14.Oct.03	<i>International Space Station Destiny Module Science Window Optical Characterization, 13th International Symposium on the Remote Sensing of Environment</i>
ATR-2003(7828)-1 (Aerospace Corporation)	17.Jan.03	<i>International Space Station Cupola Scratch Pane Window Optical Test Results</i>
JSC/CB-01-140 Crew Consensus Report	31.Dec.01	<i>Second Intravehicular Activity (IVA) Human Factors/Ergonomic Evaluation of the International Space Station (ISS) Cupola</i>
Visintine, J.T. ISS/Boeing External Contamination Analysis and Integration Team	09.May.01	<i>Shuttle Orbiter Condensable Outgassing Rate Measurements</i>
ATR 2000(2112)-1 (Aerospace Corporation)	Mar.00	<i>International Space Station Destiny Module Science Window Optical Properties and Wavefront Verification Test Results</i>
JSC/CB-00-009 Crew Consensus Report	31.Jan.00	<i>Intravehicular Activity (IVA) Human Factors/Ergonomic Evaluation of the International Space Station (ISS) Cupola</i>
ATM No. 99(2110)-1 (Aerospace Corporation)	31.Oct.99	<i>ISS Window Observational Research Facility Dynamic Stability Analysis</i>
KA/SH(WSTF) ISS/Attached Payloads External Contamination Technical Interchange Meeting	06.May.99	<i>Passive Contamination Monitor - Alpha Magnetic Spectrometer and ESCA Analysis of Witness Plates</i>
JSC-STIC-VITO Window Testing Report	26.Feb.99	<i>JSC Scientific and Technical Information Center-Vehicle Integration and Test Office Window Testing Report (Pilkington)</i>
LLIS-0754: PD-ED-1233 & 1263, & PT-TE-1410	01.Feb.99	<i>NASA Technical Memorandum 4322A, NASA-GSFC Reliability Preferred Practices for Design and Test, Contamination Control Program.</i>
LLIS 0670 & 0778	01.Feb.99	<i>GSFC Public Lessons Learned Entry 0670 & 0778</i>

AIAA 98-0391	Jan.98	<i>Development of the International Space Station High Optical Quality Science Window, AIAA-Reno, Nevada</i>
ATR-97(7434)-49 (Aerospace Corporation)	Sep.97	<i>Test and Analysis of Russian and U.S. Materials Utilized on ISS</i>
MIL-PRF-13830B	09.Jan.97	<i>Optical Components for Fire Control Instruments; General Specification Governing the Manufacture, Assembly, and Inspection of</i>
SSPO 96(7434)-59 (Aerospace Corporation)	Sep.96	<i>Analysis of the Laboratory Module Nadir Science Window for Optical Degradation Due to Thermal Gradients and Stress</i>
SSPO 96(7434)-55	Sep.96	<i>Analysis of External Contamination on the ISS</i>
LLIS 0352	08.Dec.94	<i>NASA-GSFC Public Lessons Learned Entry 0352</i>
TR-0091(6508-21)-1 (Aerospace Corporation)	1991	<i>Space Shuttle Overhead Window Optical Tests, Final Report</i>
AIAA No. 71-472	Apr.71	<i>Light Scatter From Contaminated Spacecraft Windows</i>
NASA TN D-6721	1971	<i>Apollo Experience Report - Window Contamination</i>
<i>Science of Advanced Materials and Process Engineering Series, Vol. 11</i>	1967	<i>Gemini Window Contamination Due to Outgassing of Silicones</i>

Window Optical Performance Requirements

1.0 Window Optical Characteristics

The optical quality of a window port determines the types of instruments that can be used effectively with it as well as the quality of viewing available to the crew. Unless otherwise specified, the following requirements shall apply to all window categories. Requirements in this section are not required to be verified under flight loads, pressure loads, and temperature gradients unless otherwise specified.

1.1 Striae

Striae shall be per MIL-G-174 Grade A or better for all categories of windows.

Rationale: It is important for window materials to have excellent index of refraction homogeneity. Striae are spatially short range variations in the index of refraction thereby causing localized wavefront errors. Using quality materials easily avoids issues with striae.

1.2 Finished Window Performance

Requirements stated in this section shall be met after all optical coatings have been applied and, if applicable, after all tempering and laminating steps have been completed.

1.2.1 Parallelism

Each surface of a multi-element window shall be within 0.2 degrees minimum and 1.5 degrees maximum of being parallel to all other element surfaces.

1.2.2 Wedge

The wedge of individual window panes shall be as specified in Table 1-1 Wedge Requirements for Window Panes.

Table 1-1 Wedge Requirements for Window Panes

Category	Wedge
A	<i>No more than 2.5 arc-seconds in any direction.</i>
B	<i>No more than 10 arc-seconds in any direction.</i>
C	<i>No more than 1 arc-minute in any direction.</i>
D	<i>No more than 5 arc minutes in any direction</i>

1. The wedge orientation shall be marked on each pane in an inconspicuous area such as on the edge of the pane or within 13 mm (~0.5 in) of the perimeter of the clear viewing area.
2. The individual window panes shall be assembled and positioned in the frame for a window assembly such that line of sight deviation is minimized wherever possible.

Rationale: Wedge is the degree that two window pane surfaces are parallel to each other. Wedge causes line of sight deviation when viewing through the window as well as distortion for larger aperture optical systems. Instruments such as range finders, sextants, stadimeters, and pointing lasers are sensitive to the amount of line of sight deviation errors induced by a window port. If such instruments are going to be used, the wedge requirement should be reviewed to ensure that these instruments can be supported. Minimizing line of sight deviation is straightforward for circular window ports in that each pane can be rotated to an optimal position; however, minimizing line of sight deviation may be problematic for non-circular window ports because the shape of the window itself and the window frame structure limit the possible installation orientations (e.g.: a rectangular pane can be installed in only a limited number of orientations).

1.2.3 Birefringence

Birefringence for all categories of window ports shall be less than 12 nm/cm or the wavefront error contribution due to birefringence shall be measured and included when calculating the total wavefront error specified in Wavefront Quality section of this standard.

Rationale: Stress within optical materials generates an anisotropic index of refraction. The effect of stress is most pronounced in transmissive optics, where it can severely affect functional performance. Transmitted wavefront error includes contributions from each window pane surface, the window material, and the birefringence. Birefringence causes a material inhomogeneity that results in an optical path difference that is dependent on the polarization of the incident light. Because of birefringence, the transmitted wavefront of the window will have different profiles for different orientations of polarization. This requirement allows for use of standard annealed window materials that generally have a birefringence of less than 10 nm/cm, or other materials for which the birefringence may be higher, but that the total wavefront error specified in the Wavefront Quality section of this standard can be met.

1.2.4 Reflectance

Specular reflectance of normally incident light between 450 and 800 nanometers from each window surface shall not exceed 2% absolute. Even though specular reflectance from an individual surface can be as high as 2% absolute, transmittance requirements may require a lower specular reflectance on one or more panes. The external-most surfaces of windows on vehicles exposed to terrestrial atmospheric reentry and windows not exposed to external illumination such as hatch windows between modules are exempt from this requirement.

Rationale: Whenever light illuminates an interface where the refractive index changes, partial reflection occurs. Approximately a 4% loss due to reflection occurs at an air-glass interface. A single pane will reflect as much as 8% or more of the incident light. When using multiple panes this number can be as high as 24% or more in a three pane configuration and 32% or more in a four pane configuration.

If a material such as sapphire were used, a 3 pane window port would have reflection losses of up to 46%. Anti-reflective (AR) coatings applied to surfaces where index of refraction differences are present reduce the amount of light that is reflected to about 1% per surface, increasing transmittance and permitting not only the use of many types of camera lenses but also optical (laser) and infrared range finding devices.

Viewing for piloting is also vastly improved. Common, readily available AR coatings meet the 2% requirement. External window panes are exempted from having an AR coating on reusable terrestrial reentry vehicles to accommodate issues with re-entry heating and to permit ease of cleaning for vehicle turnaround. Observation, photography, and viewing tasks, particularly piloting, require clear viewing through the window. Limiting reflectance permits viewing through the window without interference from interior items reflected in the window.

1.2.5 Transmittance

Transmittance for window assemblies shall be per Table 1-2 Transmittance Requirements in the Visible Spectrum and Table 1-3 Transmittance Requirements in the Infrared Spectrum.

Table 1-2 Transmittance Requirements in the Visible Spectrum

Category	A	B	C	D
Wavelength Band (nm)	425 ≤ □ ≤ 800		425 ≤ □ ≤ 700	
Transmittance	≥ 90%		≥ 80%	

Table 1-3 Transmittance Requirements in the Infrared Spectrum

Category	A	B	C	D
Wavelength Band (nm)	800 ≤ □ ≤ 1100		700 ≤ □ ≤ 1100	
Transmittance	≥ 50%		≥ 50%	

1.2.6 Transmittance over the Life of the Window

During the operational life of the window radiation and ultraviolet exposure as defined by the applicable program/mission, shall not reduce the transmittance of any window below the transmittance requirements stated in Table 1-2 Transmittance Requirements in the Visible Spectrum and in Table 1-3 Transmittance Requirements in the Infrared Spectrum.

Rationale: Hostile environments created by short wavelength electromagnetic radiation such as ultra-violet, X-ray, and gamma-ray radiation or from particle fluxes such as alpha particles, beta particles, protons, and neutrons can produce discoloration and absorption losses in transparent materials particularly optical glasses. Ionizing radiation can produce free holes and electrons that can then become trapped, thus forming defect centers. These defect centers cause an increase in optical absorption in the visible portion of the spectrum leading to a darkening of the material. The associated loss in transmission is detrimental to the optical performance of a window and any optical system used with it and

must, therefore, be minimized. In order to optimize window optical performance especially over the life of the window, optical materials that have been stabilized for applications within the particular radiation environment expected must be used or replacement panes provided. Radiation stabilized transparent materials have been developed for use in such hostile environments.

1.2.7 Color Balance

For a D65 Standard Illuminant each finished pane shall exhibit a color shift that stays within a rectangular color space on the 1931 CIE Chromaticity Diagram whose boundaries defined as the x coordinate between 0.312 and 0.321 (inclusive) and the y coordinate between 0.329 and 0.340 inclusive. The bounding rectangular box representing the allowable color shift, along with the location of the unshifted D65 Standard Illuminant, are in Figure 1-1 Chromaticity Diagram.

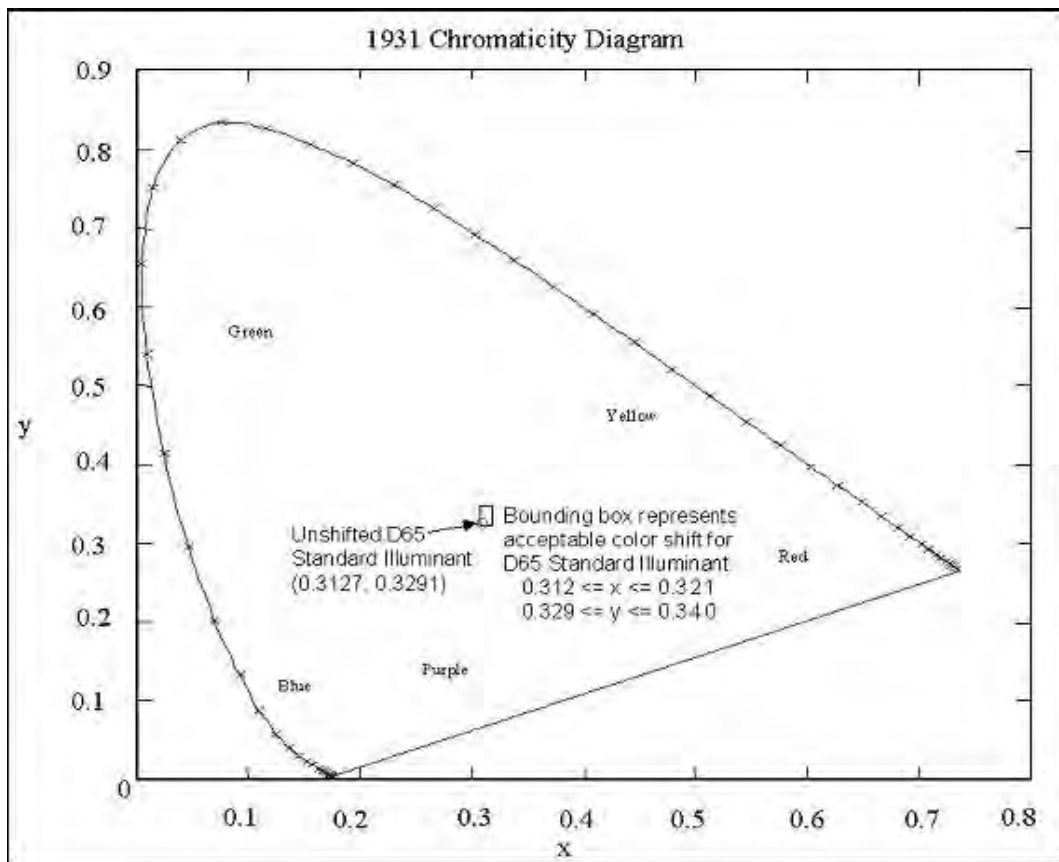


Figure 1-1 Chromaticity Diagram

1.2.8 Wavefront Quality

1.2.8.1 Wavefront Quality at Normal Incidence

For viewing angles at normal incidence where the reference wavelength is 632.8 nm, the peak-to-valley transmitted wavefront error through the combination of all window panes for the window port shall not exceed the limits specified in Table 1-4 Peak-to-Valley Transmitted Wavefront Error Limits for Normal Incidence Viewing (excluding flight loads, pressure loads, and temperature gradients).

Table 1-4 Peak-to-Valley Transmitted Wavefront Error Limits for Normal Incidence Viewing

Category A windows	1/10 wave over any 150 mm (~6 in) diameter sub-aperture within the central 80% (minimum) of the physical area of the window.
Category B windows	1/4 wave over any 100 mm (~4 in) diameter sub-aperture within the central 80% (minimum) of the physical area of the window.
Category C windows	1/4 wave over any 50 mm (~2 in) diameter sub-aperture within the central 80% (minimum) of the physical area of the window.
Category D windows	1/4 wave over any 25 mm (~1 in) diameter sub-aperture within the central 50% (minimum) of the physical area of the window.

Rationale: See Rayleigh Limit in the Glossary of Terms and Definitions

1.2.8.2 Wavefront Quality for Acute Angle Viewing for Windows

For viewing angles at normal incidence where the reference wavelength is 632.8 nm, the peak-to-valley transmitted wavefront error through all window panes of the window port shall not exceed the limits as specified in Table 1-5 Peak-to-Valley Transmitted Wavefront Error Limits for Acute Angle Viewing (excluding flight loads, pressure loads, and temperature gradients).

Table 1-5 Peak-to-Valley Transmitted Wavefront Error Limits for Acute Viewing

Category A windows	1/4 wave over any 150 mm (~6 in) inch diameter sub-aperture within the central 60 percent (minimum) of the physical area of the window.
Category B windows	1/2 wave over any 100 mm (~4 in) diameter sub-aperture within the central 60 percent (minimum) of the physical area of the window.
Category C windows	1 wave over any 50 mm (~2 in) diameter sub-aperture within the central 60 percent (minimum) of the physical area of the window.
Category D windows	1 wave over any 25 mm (~1 in) diameter sub-aperture within the central 60 percent (minimum) of the physical area of the window.

Rationale: See Rayleigh Limit in the Glossary of Terms and Definitions

1.2.8.3 Induced Wavefront Errors

For Category A windows, the effect of the thermal and stress environments on wavefront for the normal and worse case operational configurations and conditions to which the window will be exposed shall be determined and the data provided.

Rationale: Thermal and stress variations across a window can detrimentally affect optical systems viewing through it because the index of refraction of materials changes with temperature and stress. Except in the case of windows made of tempered materials and possibly windows made of thin panes, wavefront induced degradation due to stress is not typically a significant issue. For thermally induced variations, there are two types to consider, axial and radial. With axial temperature gradients, the temperature varies through the thickness of each pane causing uniform bending and generally introduces only a negligible power term (defocus). With a radial temperature gradient, the window to first order acts like a lens with the optical path difference symmetrically changing with radius from the center. When utilizing the window at the center spherical aberration and defocus are the most common aberrations for which significant correction can be made by applying defocus corrections (refocusing) to the optical instrument being used. The report of the analysis conducted for the ISS Laboratory Module Nadir Science Window is listed in the references and is cited here as an example of the type of analysis and report that are required for this purpose.

1.2.9 Haze

1.2.9.1 Haze Specification for A and B Windows

Haze shall be less than 0.5% per ASTM D1003, Procedure A after all coatings and laminates are applied.

1.2.9.2 Haze Specification for C and D Windows

Haze shall be less than 1% per ASTM D1003, Procedure A after all coatings and laminates are applied.

1.2.10 Visual Uniformity and Coatings

The visual uniformity and durability of the window surfaces and coatings shall be per MIL-C-48497 as amended in Table 1-6 Modifications to MIL-C-48497 with the exception of surface defects which shall meet the requirements of section 1.3.2.

Table 1-6 Modifications to MIL-C-48497

Substrate		Modifications by Substrate
Exposed to Internal Crew Contact or the External Environment	Glass or Ceramic	Sections 3.4 3.4.2.1 and 4.5.4.1 are amended to add respectively -20°F and +20°F to the minimum and maximum exposure temperatures specified.
	Other Materials	Sections 3.4.2.1 and 4.5.4.1 are amended to add respectively -20°F and +20°F to the minimum and maximum exposure temperatures specified. Section 3.4.2.2 is eliminated Section 3.4.3.1 is eliminated and instead the coating shall be required to pass a Taber abrasion resistance test per ASTM D1044 with no more than 3.0% haze after 500 revolutions of a CS10F wheel under a load of 500 grams.
Not exposed to Crew Contact or the External Environment	All Materials	Sections 3.4.2.1 and 4.5.4.1 are amended to add respectively -20°F and +20°F to the minimum and maximum exposure temperatures specified. Section 3.4.3.1 is eliminated.

Rationale: Coatings are typically applied to window surfaces to manage reflectance and transmittance, and, like the window surfaces and substrate materials to which they are applied, these coatings will negatively affect color balance and wavefront quality if they are not uniform or become marred, pitted, or damaged with use.

1.3 Allowable Defects

1.3.1 Inclusions

Inclusions are defects such as seeds, bubbles, small culetts, and dust or dirt particles within the window material itself or in an interlayer in a pane assembled of laminates and substrate. Inclusions class for any window material and any interlayer shall be per Table 1-7 Required Inclusion Number per MIL-G-174.

Table 1-7 Required Inclusion Number per MIL-G-174

Category	A	B	C	D
Inclusion number	2	2	3	3

1.3.2 Surface Defects

1.3.2.1 Surface Imperfection Tolerances for All Window Categories

ISO 10110-7 shall be used to limit surface imperfections. No more than one surface imperfection of grade size A = 0.40 mm per 20 mm diameter area of the window port shall be allowed except for open inclusions which are specified below. Any combination of imperfections is allowed but imperfections with a grade number greater than 0.04 shall have a total projected area of less than 0.25mm² per 20 mm diameter of area (i.e., A" = 0.25) where A" is scratch width per ISO 10110-7. No more than one thin surface imperfection longer than 2 mm and a maximum width of 0.08 mm or less per 20 mm diameter of area shall be permitted. No scratches longer than 2 mm are permitted. The sum of the lengths of all scratches shall not exceed 10mm.

Rationale: The above specification is nominally equivalent to an 80-40 scratch-dig specification as described in MIL-O-13830A, but clears up the ambiguity present in the Mil-Standard. An 80-40 equivalent specification was selected as appropriate for windows where the focal plane is typically greater than 15 diopters from the window for the majority of instruments that would be used. Only very short focal length ("point and shoot") cameras could be affected if the cameras are used against the window. Since long scratches are more visible to the eye, a separate requirement is specified.

1.3.2.2 Open Inclusions for Category A and B Windows

1. The maximum number of open inclusions per surface or interlayer shall not exceed three.
2. No single open inclusion shall exceed 0.50 mm (~0.02 in) in diameter.
3. Open inclusions shall be separated by not less than 50 mm (~1.97 in).
4. Open inclusions equal or less than 0.08 mm (~0.00315 in) in diameter may be disregarded.

1.3.2.3 Open Inclusions for Category C and D Windows

1. The maximum number of open inclusions per surface or interlayer shall not exceed five.
2. No single open inclusion shall exceed 1.0 mm (~0.04 in) in diameter.

3. Open inclusions shall be separated by not less than 75 mm (~2.95 in).
4. Open inclusions equal to or less than 0.1 mm (~0.004 in) in diameter may be disregarded.

1.3.3 Polycarbonates, Acrylics, and General Plastics Including Laminates

Polycarbonates, acrylics, and general plastics including laminates shall meet the Allowable Defect requirements in this section as specified respectively for other materials.

Window Optical and Functional Performance Verification Methods

The verification methodologies specified throughout this appendix refer to ground test conditions. On-orbit or extraterrestrial surface conditions need not be simulated except where specified or required for specialized tasks. All verifications shall be performed on flight articles except where specified. All test procedures, data, and reports shall be delivered to the customer upon delivery of the product.

2.0 Window Optical Characteristics

Window optical characteristics shall be verified as specified below and summarized in a test report. The verifications that follow shall be used.

2.1 Striae

Striae shall be verified by test. Testing shall be performed on witness samples.

2.2 Finished Window Performance

Verification that all tests have been performed on the finished ports shall be done by analysis of the data packs provided from the tests below.

2.2.1 Parallelism

Parallelism shall be verified by analysis of the window assembly hardware (e.g., springs, seals, frames, etc.) as configured with its prospective panes to ensure component tolerances do not allow exceedance of the requirement. If the analysis shows that the design tolerances may be close to being exceeded, then parallelism shall be verified by measurement and test of the flight article.

2.2.2 Wedge

Wedge shall be verified by inspection of individual panes. Vendor measurements of wedge are acceptable for this purpose and shall be provided in a data pack. Inspection of the data pack will verify that the requirement is met.

2.2.3 Birefringence

Birefringence shall be verified by test of the finished panes

2.2.4 Reflectance

Reflectance shall be verified by test as follows:

1. The reflectance for all categories of windows shall be measured for each surface of each pane between at least 450 and 800 nm in 1 nm increments.
2. A spreadsheet of all measured reflectance values shall be provided.

Witness samples may be used in lieu of actual flight panes.

2.2.5 Transmittance

Transmittance for all categories of windows shall be verified by test as follows:

1. The transmittance shall be measured between at least 180 and 2500 nm in 1 nm increments except that for Category C and D windows that will not be exposed to external illumination the transmittance shall be measured between at least 425 and 1100 nm in 1 nm increments.
2. A spreadsheet of these transmittance values shall be provided.
3. For all categories of windows, the transmittance may be characterized using witness samples in lieu of actual flight panes if the samples are large enough to capture the enhanced transmittance realized from multi-pane reflections otherwise testing/inspection shall be performed on flight articles.

Rationale: The extended bandwidth for transmittance data beyond that specified in the sections on transmittance is required for ocular and skin hazard evaluations.

Transmittance Requirements shall also be verified by test and analysis as specified below.

A. Additional Transmittance Verification for Category A Windows

1. Category A window transmittance shall also be verified by additional measurements of transmittance through the actual flight window panes in the normal flight configuration.
2. The measurements shall be sampled across the spectrum specified in the Transmittance section of this standard in 20 nm or narrower increments.
3. A minimum of 15 samples shall be taken and compared with the witness sample results.
4. The transmittance for Category A windows shall be measured for view angles between 0 degrees (normal to the plane of the window) and plus and minus 45 degrees of the normal in 5 degree increments in one plane.

B. Additional Transmittance Verification for Category B Windows

The transmittance for Category B windows shall also be verified by additional measurements of transmittance through the actual flight panes according to the procedures in the Additional Transmittance Verification for Category A Windows section of this standard if hyper- or multi-spectral instruments are to be used with the Category B window or where calibration is required for other purposes.

2.2.6 Transmittance over the Life of the Window

Transmittance over the life of the window shall be verified by analysis and test. Testing shall be performed on witness samples.

An analysis shall be performed to determine the effect of the natural and induced environments on window transmittance. If properties of the selected window material are not well known or defined, an accelerated life test shall be performed to determine the effect of natural and induced environments on window transmittance.

Rationale: Natural and induced environments can affect the material properties of the window and cause degradation of transmittance.

Color balance shall be verified by test. Witness samples may be used in lieu of flight articles for this testing.

2.2.7 Color Balance

Color balance shall be verified by test. Witness samples may be used in lieu of flight articles for this testing.

2.2.8 Wavefront Quality

2.2.8.1 Wavefront Quality at Normal Incidence

For Category A and B window ports wavefront shall be verified by test and analysis of flight articles per Method A and Method B below:

(A) Method A of Wavefront Verification

1. Each individual pane shall be tested over at least six sub-apertures distributed within the test area, defined as a minimum of 80% of the physical area of the pane, with one test aperture being located in the center of this area, and with one test aperture being located over the optically worst part of the pane within the test area. This test will measure the wavefront error at an angle of zero degrees from the normal for the six sub-apertures.

Note: The transmitted wavefront error shall be tested over the full test area defined, but may be tested over smaller sub-apertures if the wavefront errors are too large, or instrumentation is not available to test over the entire test area.

2. An additional test shall be conducted to measure wavefront of four sub-apertures distributed over the central 60% of the physical area of the pane for a view angle of ± 30 degrees.

(B) Method B of Wavefront Verification

1. An interferometric test shall be performed on all panes together that make up each flight window assembly, including any protective panes and laminates that are used. If the protective pane is easily removable within one minute without the use of tools and reinstallable within one minute without the use of tools by one crew member, then separate tests shall be performed with it in place and removed. This test shall measure the wavefront error over at least six sub-apertures distributed within the test area of the window port (defined as a minimum of 80% of the physical area of the window port) with one test aperture being located in the center of the clear aperture, and with one test aperture being located over the optically worst area of the pane within the test area.

Note: The transmitted wavefront error shall be tested over the full test aperture defined, but may be tested over smaller sub-apertures if the wavefront errors are too large, or instrumentation is not available to test the entire area.

(C) Data Requirements

1. For Category A and B window ports each surface of all individual panes shall be tested in reflectance at normal incidence over at least the test area defined and the surface figures recorded.
2. Wavefront Data Packs shall include images of the interferograms recorded at all test apertures (including the large apertures), the total peak-to-valley wavefront error measured at each test aperture, and a breakdown of the total wavefront error measured at each test aperture into the individual third order aberrations (tilt, power, coma, spherical aberration, and astigmatism). Any spare panes fabricated shall also be tested.

For Category C and D window ports wavefront shall be verified by test and analysis using either Method A or Method B above.

2.2.8.2 Wavefront Quality for Acute Angle Viewing for Category A and B Windows

For Category A and B window ports, wavefront shall be verified by test and analysis of flight articles as specified below. .

1. An interferometric test shall be performed on all panes together that make up each flight window assembly, including any protective panes and laminates that are used. If the protective pane is easily removable within one minute without the use of tools and reinstallable within one minute without the use of tools by one crew member, then separate tests shall be performed with it in place and removed. This test shall measure the wavefront error over at least four sub-apertures distributed within the test area of the window port (defined as a minimum of 60% of the physical area of the window port) for view angles of +/-30 degrees from the normal to the plane of the window with one test aperture being located in the center of the clear aperture, and with one test aperture being located over the optically worst area of the pane within the test area.

Note: The transmitted wavefront error shall be tested over the full test aperture defined, but may be tested over smaller sub-apertures if the wavefront errors are too large, or instrumentation is not available to test entire test area.

2. Wavefront Data Packs shall include images of the interferograms recorded at all test apertures (including the large apertures), the total peak-to-valley wavefront error measured at each test aperture, and a breakdown of the total wavefront error measured at each test aperture into the individual third order aberrations (tilt, power, coma, spherical aberration, and astigmatism). Any spare panes fabricated shall also be tested.

2.2.8.3 Induced Wavefront Errors

Induced wavefront errors caused by thermal and stress environments under the normal and worse case operational conditions and configurations to which the window will be exposed shall be determined by analysis.

Rationale: An individual program will need to review the analysis to determine whether some operational configurations and attitudes shall be avoided when using the window with any planned optical instruments to ensure that they can be properly refocused; that is, a defocus correction can be applied to correct for environmentally induced degradations. A detailed example of a thermal and stress analysis can be found in the References Section (SSPO 96(7434)-59).

2.2.9 Haze

2.2.9.1 Haze Specification for A and B Windows

Haze shall be verified by inspection and test of flight articles per ASTM D1003, Procedure A and by analysis.

2.2.9.2 Haze Specification for C and D Windows

Haze shall be verified by inspection and test of flight articles per ASTM D1003, Procedure A and by analysis.

2.2.10 Visual Uniformity and Coatings

1. Window coating durability shall be verified by test of coated witness samples per MIL-C-48497, Sections 3.4 and 3.5, as amended in Table 2-1 below and by analysis.
2. The eraser to be used for the purpose specified in MIL-C-48497 shall be per MIL-E12397.
3. Visual Uniformity shall be verified by test on witness samples per MIL-C-48497, paragraphs 4.5.2.1, 4.5.2.2, 4.5.2.3, 4.5.2.4, and 4.5.2.5.1 except that surface defects shall be verified per the Allowable Defects verification section of this document.

Table 2-1 Coating Durability Requirements per MIL-C-48497

Substrate		Section 3.4
Exposed to Internal Crew Contact	Glass or Ceramic	Section 3.4.2.1 is amended to add respectively +20 °F and -20 °F to the maximum and minimum temperatures specified.
	Other Material	Section 3.4.2.1 is amended to add respectively +20 °F and -20 °F to the maximum and minimum temperatures specified. Section 3.4.2.2 is eliminated Section 3.4.3.1 is eliminated The coating shall be required to pass a Taber abrasion resistance test per ASTM D1044 with no more than 3.0% haze after 500 revolutions of a CS10F wheel under a load of 500 grams.
Not exposed to crew contact	All materials	Section 3.4.2.1 is amended to add respectively +20 °F and -20 °F to the maximum and minimum temperatures specified. Section 3.4.3.1 is eliminated.

2.3 Allowable Defects

2.3.1 Inclusions

Testing / inspection shall be performed on flight articles as follows:

1. Inclusion class requirements for each pane shall be verified by inspection.
2. A spreadsheet shall be maintained for each pane delivered to the customer compiling inspection results that identify every defect in each pane.
3. The defects shall be classified as inclusions, open inclusions or seeds, or other anomalous marks.
4. The data on the spreadsheet shall be used to perform the appropriate calculations to identify panes that pass or fail the specified requirements.
5. The spreadsheet shall be delivered as part of the pane’s acceptance data package.

2.3.2 Surface Defects.

2.3.2.1 Surface Imperfection Tolerances for All Window Categories

Surface imperfections shall be verified per Method 1 of ISO 10110-7.

Rationale: Surface imperfections are localized blemishes such as scratches that are any marking or tearing of the glass surface, and digs which are small rough spots on

the glass surface similar to pits in appearance. An open bubble is considered a dig. Surface imperfections degrade performance because they scatter light. The light scattered is in proportion to the area of the imperfection relative to the area of the optical clear aperture.

2.3.2.2 Open Inclusions for Category A and B Windows

Testing / inspection shall be performed on flight articles as follows:

1. For Category A and B windows open inclusions requirements for each pane shall be verified by inspection.
2. A spreadsheet shall be maintained for each pane delivered to the customer compiling inspection results that identify every defect in each pane.
3. The defects shall be classified as open inclusions or seeds, or other anomalous marks.
4. The data in the spreadsheet shall be used to perform the appropriate calculations to identify panes that pass or fail the specified requirements.
5. The spreadsheet shall be delivered as part of the pane's acceptance data package.

2.3.2.3 Open Inclusions for Category C and D Windows

Testing / inspection shall be performed on flight articles as follows:

1. For Category C and D windows open inclusions requirements for each pane shall be verified by inspection.
2. A spreadsheet shall be maintained for each pane delivered to the customer compiling inspection results that identify every defect in each pane.
3. The defects shall be classified as open inclusions or seeds, or other anomalous marks.
4. The spreadsheet shall perform the appropriate calculations to identify panes that pass or fail the specified requirements.
5. The spreadsheet shall be delivered as part of the pane's acceptance data package.

2.3.3 Polycarbonates, Acrylics, and General Plastics Including Laminates

For polycarbonates, acrylics, and general plastics including laminates allowable defects shall be verified as specified respectively for other materials in this section.

3.0 Windows

No Requirement to be verified under this heading.

3.0.1 Introduction

No Requirement to be verified under this heading.

3.0.2 Window Design and Task Support

No Requirement to be verified under this heading.

3.0.2.1 Window Categories

The design parameters that match window viewing area size and performance to the required tasks shall be verified by inspection and test of the flight window port and by analysis.

3.0.2.2 Minimum Number of Windows

The minimum number of windows shall be verified by inspection of the drawings and the flight article.

3.0.2.3 Multipurpose Windows

The design parameters for multipurpose windows that match window viewing area size and optical performance to the required tasks shall be verified by inspection and test of the flight window port and by analysis.

3.0.2.4 Special Purpose Windows

The design parameters for special purpose windows that match window viewing area size and optical performance to the required tasks shall be verified by inspection and test of the flight window port and by analysis.

3.0.3 Window Location and Orientation

Window Location and Orientation shall be verified by inspection of the drawings and the flight article.

3.0.3.1 Window Visual Field Window visual field shall be verified by analysis.

3.0.3.2 Window Vision (Fields of View) for Piloting

Window vision (Fields of View) for piloting shall be verified by analysis.

3.0.3.2.1 Winged Vehicles

Windows for Winged Vehicles shall be verified inspection and by analysis.

3.0.3.2.1.1 The Window Forward Vision Area

The window forward vision area shall be verified by analysis.

3.0.3.2.1.1.1 Forward Vision Area Up-vision Minimums

The forward vision area up-vision minimums shall be verified by analysis.

3.0.3.2.1.1.2 Forward Vision Area Down-vision Minimums

The forward vision area down-vision minimums shall be verified by analysis. The forward vision area down-vision minimums shall be verified by analysis.

3.0.3.2.1.1.3 Forward Vision Area Inboard-vision Minimums

The forward vision area inboard-vision minimums shall be verified by analysis.

3.0.3.2.1.1.4 Forward Vision Area Outboard-vision Minimums

The forward vision area outboard-vision minimums shall be verified by analysis.

3.0.3.2.1.2 The Window Lateral Vision Area

The window lateral vision area shall be verified by analysis.

3.0.3.2.1.2.1. Lateral Vision Area Up-vision Minimums

The lateral vision area up-vision minimums shall be verified by analysis.

3.0.3.2.1.2.2 Lateral Vision Area Down-vision Minimums

The lateral vision area down-vision minimums shall be verified by analysis.

3.0.3.2.1.3 The Window Side Vision Area

The window side vision area shall be verified by analysis.

3.0.3.2.1.3.1 Side Vision Area Up-vision Minimums

The side vision area up-vision minimums shall be verified by analysis.

3.0.3.2.1.3.2 Side Vision Area Aft-vision Minimums

The side vision area aft-vision minimums shall be verified by analysis.

3.0.3.2.1.4 Upward Vision

Window upward vision shall be verified by inspection and by analysis.

3.0.3.2.1.5 Rearward Vision

Window rearward vision shall be verified by inspection and by analysis.

3.0.3.2.2 Non-Winged Vehicles

Windows for non-winged vehicles shall be verified by inspection and by analysis.

3.0.3.2.2.1 The Window Forward Vision Area

The window forward vision area shall be verified by analysis.

3.0.3.2.2.1.1 Forward Vision Area Up-vision Minimums

The forward vision area up-vision minimums shall be verified by analysis.

3.0.3.2.2.1.2 Forward Vision Area Down-vision Minimums

The forward vision area down-vision minimums shall be verified by analysis.

3.0.3.2.2.1.3 Forward Vision Area Inboard-vision Minimums

The forward vision area inboard-vision minimums shall be verified by analysis.

3.0.3.2.2.1.4 Forward Vision Area Outboard-vision Minimums

The forward vision area outboard-vision minimums shall be verified by analysis.

3.0.3.3 Inboard Window Obscuration Exclusion Zone

The inboard window obscuration exclusion zone shall be verified by analysis.

3.0.3.4 Outboard Window Obscuration Exclusion Zone

The outboard window obscuration exclusion zone shall be verified by analysis.

3.0.3.5 Optical Uniformity

Optical uniformity shall be verified by test on flight articles as follows to verify that all finished window panes meet the requirements in the Optical Uniformity section of this standard.

1. A grid target shall be constructed that contains horizontal and vertical black lines on a white background that extend over the entire target. Each of the horizontal lines shall be 30.5 cm apart (+/- 0.5 cm). Each of the vertical lines shall be 30.5 cm (+/- 0.5 cm) apart. The size of the target shall be at least three times as large as the window pane being tested.
2. A dot target shall be constructed that contains a series black dots 0.635 cm (+/- 0.35 cm) in size that are separated by a distance of 30.5 cm (+/- 0.5 cm) and placed in uniform rows and columns that extend over the entire target. The target shall be at least three times as large as the window pane being tested.
3. For each test described below, NASA shall select three observers who shall each meet the visual acuity requirements of a pilot-astronaut and who in turn shall be at a distance of 30.5 cm (+/- 0.5 cm) from the window and viewing through it at the target placed 122 cm (+/- 2 cm) on the opposite side of the window from the observer with the centers of the window and the target in line.
4. The following tests shall be performed by each observer without their having prior knowledge of any possible optical defects on the pane being tested:
 - a. When viewing each target, the observer is to focus on the target and not on the surface or body of the pane of the window.

- b. The observer is to scan the target through the designated quality area of the pane over its entire area.
 - c. The observer shall perform a minimum of two scans. One using the eyes only without moving the head and another while moving the head side to side and then up and down.
 - d. If the vision of any one observer is pulled to, focuses on, or detects an optical defect because of size, intensity, non-uniformity, grouping, or distortion; the pane will be evaluated further as described in Item 6 below.
 - e. If the lines on the grid target appear wavy or appear to curve or move non-uniformly across the target when viewed either statically (scanning using the eyes only) or when moving the head by any one observer, the pane will be evaluated further as described in Item 6 below.
 - f. If the dots on the dot target disappear and reappear, appear to blur, or produce double images either when viewed statically or when moving the head by any one observer, the pane shall be evaluated further as described in Item 6 below.
5. An optical deviation test shall be performed. Each optical defect greater than 30 arc seconds shall be further evaluated per Item 6 below.
 6. Any defect identified shall be measured to determine whether the defect violates requirements in the Window Optical Characteristics section of this standard. The verification is successful when no defects that violate requirements are identified.

Rationale: Windows must be optically uniform so as not to degrade use of the window. Windows that are composed of or that include materials other than glass such as laminates, plastic layers, and adhesives often have non-uniformities. Laminates, plastic layers, and adhesives applied non-uniformly will negatively affect optical performance. Very large defects can go undetected in wavefront measurements because they are too large to be measured by an interferometer. As reported in the references, both verifications are required to preclude deficiencies encountered with previous deliveries.

3.0.3.6 Window Shape

3.0.4 Surface Finish for Window Frame and Surrounding Structure

Surface Finish shall be verified by test on witness samples by lot for each coating or finish used. Wavelength scaling of the specular reflectance may be established by hemispheric reflectance measurements.

3.0.5. Window Surface Contamination

No Requirement to be verified under this heading.

3.0.5.1 Material Selection and Contamination Protection for Window Assembly and Installation

To prevent degradation of window performance, only materials that have passed testing per ASTM-E1559 Method B with the additions listed below shall be used in the manufacture of all window assemblies, particularly seals and shutter components. This

includes all external materials within 3 meters (~10 ft) of any window. Materials may be baked out to meet these requirements. A hardware functionality bench test shall be performed to re-verify performance after baking. Testing shall be performed on witness samples.

1. One of the three Quartz Crystal Microbalances (QCMs) used in the testing shall be at a temperature equal to or less than the coldest temperature the window is expected to attain in its operating environment.
2. The output of the E1559 tests is a condensable outgassing rate for each of the sample and collector temperatures. These rates shall be entered into a contamination model with modifications that takes into account view factors such that the degradation that the contamination would have on window transmittance is determined.
3. Exposure to UV shall be required such that the synergistic interaction between solar UV and molecular contamination, which can lead to photochemically enhanced deposition and darkening of the contaminants, is included in the model or determined by test.
4. The model shall accurately model materials that are expected to operate in a closed volume (e.g., seals) such that outgassed materials that are constrained by the volume are addressed differently than materials that outgas to space.
5. This requirement is met when the transmittance of all categories of windows are predicted to meet or exceed the requirements specified in the Transmittance and Haze sections of this standard after exposure to the outgassed materials.
6. All materials within line of sight of any window but outside the 3 meter area on the completed architectural element as configured for mission use shall be screened per NASA-STD-6016 using a CVCM level of 0.01% that is defined for sensitive surfaces. An evaluation shall be performed to determine whether a QCM temperature colder than 77° F (25° C) is needed to prevent using materials that would meet the CVCM level at 77° F (25° C), but would fail if the actual window temperature was used.
7. Photochemical deposition effects on contamination rate shall also be evaluated.

3.0.5.2 Molecular Contamination Removal for Category A, B, and C Windows

1. The provision of a means to remove contamination shall be verified by inspection of the flight article.
2. The effectiveness of the means to remove contamination for thermal contamination removal systems shall be verified by demonstration (that the heat will remove contamination) and analysis (that the system is adequate to remove contamination over the entire area of the window).
3. The effectiveness of the means to remove contamination for non-thermal contamination removal systems shall be verified by test.
4. Mockups containing substrate material that is the same as that of the flight article may be used for this purpose; however, the substrate material need not meet the optical or durability requirements contained herein.

5. Use of witness samples and engineering units where appropriate is acceptable but not necessary for this purpose.
6. Flight articles shall not be used for this purpose except for inspection of the flight article to verify provision of the contamination removal system.

3.0.5.3 Particulate Contamination Removal for Category A, B, and C Windows

1. The provision of the means to remove particulates shall be verified by inspection of the flight article.
2. The effectiveness of the means to remove particulates shall be verified by demonstration.
3. Mockups containing substrate material that is the same as that of the flight article may be used for this purpose. The substrate material used in any such mockup need not meet the optical requirements contained herein.
4. Use of witness samples and engineering units where appropriate is acceptable but not necessary for this purpose.
5. Flight articles shall not be used for this purpose except for inspection of the flight article to verify provision of the contamination removal system.

3.0.5.4 External Contamination Monitoring for Category A, B, and C Windows

1. The provision of a means to monitor contamination shall be verified by inspection of the flight article.
2. The effectiveness of the means to monitor contamination shall be verified by test for a range and sensitivity specified by an individual program.

3.0.6 Other Sources of Window Contamination and Damage

No Requirement to be verified under this heading.

3.0.6.1 Protective Panes and Covers

No Requirement to be verified under this heading.

3.0.6.1.1 External Window Protection

External protection of the outboard-most window pane shall be verified by inspection of the flight article and by demonstration as follows:

3.0.6.1.1.1 Transparent External Protection

1. Optical requirements of transparent external protection shall be by test and analysis.
2. The ability to remove external transparent protection in less than one hour with the use of standard EVA tools by one EVA crew member and the ability to reinstall external transparent protection in less than 1 hour with the use of standard EVA tools by one EVA crew member shall be verified by demonstration.

3.0.6.1.1.2 Opaque External Protection

1. Onboard manual operability of opaque external protection from fully closed to fully open in less than 10 seconds and from fully open to fully closed in less than 10 seconds shall be verified by demonstration.
2. Remote operability from onboard and a location not onboard of opaque external protection from fully closed to fully open in less than 10 seconds and from fully open to fully closed in less than 10 seconds shall be verified by demonstration.
3. Remote determination from onboard and a location not onboard of shutter or device state, either open or closed, shall be verified by demonstration.
4. Provision of a light seal as part of a shutter or device shall be verified by inspection of the flight article. Light seal efficacy shall be verified by demonstration.
5. Provision of a particulate/contamination seal as part of a shutter or device shall be verified by inspection of the flight article. Particulate/contamination seal efficacy shall be verified by analysis or demonstration using a test article. The test article need not be equipped with flight like window panes.
6. Provision of or incorporation of micrometeoroid and foreign object debris protection with the shutter or device shall be verified by inspection of the flight article. Micrometeoroid and foreign object debris protection efficacy shall be verified by analysis or demonstration using a test article. The test article need not be equipped with flight like window panes.
7. Intermediate positioning of the shutter or device between fully closed and fully open shall be verified by demonstration.
8. Manual movement of the shutter or device in either direction toward open or close by some means through its entire range of motion from the exterior of an architectural element shall be verified by demonstration.
9. The ability to remove and replace a shutter or other operable opaque external window protection device in less than two hours with the use of standard EVA tools by one EVA crewmember shall be verified by demonstration.
10. The ability to remove and replace shutter or device drive mechanisms in less than two hours with the use of standard hand tools by one crewmember shall be verified by demonstration.

3.0.6.1.2 Internal Window Protection

1. Protective pane and cover transparency shall be verified by demonstration.
2. Protective pane and cover optical requirements shall be verified by test.
3. The ability to remove internal protective panes in less than ten minutes with no more than the use of standard hand tools by one crew member and to reinstall internal protective panes in less than ten minutes with no more than the use of standard hand tools by one crew member shall be verified by demonstration.
4. Wavefront requirements of removable internal protective panes used on Category A and B windows shall be verified by test.

5. The ability to remove protective covers in less than ten seconds and to reinstall protective covers in less than ten seconds by one crew member without the use of tools or the ability to operate internal protective covers from fully closed to fully open in less than 10 seconds and from fully open to fully closed in less than 10 seconds by one crew member without the use of tools as appropriate shall be verified by demonstration.
6. Wavefront requirements of internal protective covers used on Category A and B windows that are not operable from fully closed to fully open in less than 10 seconds and from fully open to fully closed in less than 10 seconds or removable in less than ten seconds and reinstallable in less than ten seconds by one crew member without the use of tools shall be verified by test.

3.0.7 Condensation Prevention

The provision of a condensation prevention system shall be verified by inspection of the flight article.

1. The effectiveness of condensation prevention systems for exposure to the normally expected range of environmental conditions and for the interior most surfaces on Category A and B windows from human breath condensation at a mouth-to-pane distance of 10 cm (metabolic rate = 30 (+/-5) breaths/minute, single person) shall be verified by test.
2. The effectiveness of condensation prevention systems during interpane venting and pressurization shall be verified by demonstration.

3.0.7.1 Manual operation of condensation prevention systems

Manual operation of condensation prevention systems shall be verified by demonstration.

3.0.8 Window Transmittance and Non-Ionizing Radiation

Crew safety requirements will be verified by analysis per the requirements of NASA Standard 3000, Section 5.7.3, Human System Integration Standards, Section 5.7.3.1, and Spaceflight Human Systems Standard Volume II, Section 5.8.2 which are considered to have been met if the window port being considered has transmittance values that yield acceptable viewing times that are less than or equal to those specified in the tables within the referenced standards. If the window port does not meet the specified values, then additional means such as sunglasses, protective filters, etc. may be used to meet the required attenuation. An analysis shall be performed to show that the attenuation provided by any additional means in combination with the windows satisfies the crew safety requirements.

3.0.8.1 Attenuation and Filtering of Non-ionizing Radiation

1. The provision of the means to attenuate or filter non-ionizing radiation shall be verified by inspection of the flight article.
2. Non-permanent attachment of non-ionizing radiation attenuation devices or filters shall be verified by demonstration.

3. The ability to remove non-ionizing radiation attenuation devices or filters in less than 10 seconds without the use of tools and to reinstall non-ionizing radiation filters in less than 10 seconds without the use of tools by one crew member shall be verified by demonstration.
4. Optical performance requirements of non-ionizing radiation attenuation devices or filters shall be verified by test and analysis.

3.0.9 Window Support

3.0.9.1 Electronic Connectivity for Window Support

3.0.9.2 Window Support in Microgravity

3.0.10 Research Needs

No Requirement to be verified under this heading.

3.0.11 References

No Requirement to be verified under this heading.

GLOSSARY OPTICAL OF TERMS AND CONVENTIONS

Term	Definition
Birefringence	Birefringence in a material refers to the difference in index of refraction that is a function of incident light polarization. Birefringence can be an intrinsic material property such as in sapphire, or be induced by stress in a material that otherwise does not display birefringence.
Bubbles	Gaseous voids entrapped within a bulk material such as in glass, plastics, laminates, etc. of generally circular cross section which are usually the result of the manufacturing process.
Clear Viewing Aperture	The area of window that is not covered by the window assembly frame or other structure that would block incident light rays.
Deviation	Deviation refers to the change in angle that an emergent ray of light makes with the incident ray as it passes through a window pane or port, or other optical device.
Diffuse Reflectance	The fraction of incident light or other type of wave within a specified wavelength band that is reflected from a surface uniformly in all directions, regardless of the angle of incidence of the incident light (rays) or wave. A truly diffusely (Lambertian) reflective surface has the same luminance (appears to have the same brightness) from all viewpoints, regardless of the direction of the source relative to the surface. This type of reflection is associated with matte or "flat" surface treatments on objects, and is contrasted with specular reflectance. Most surfaces exhibit a combination of specular and diffuse reflectance.
Diffuse Reflection	The fraction of incident light power within a specified wavelength band that is reflected from a surface uniformly in all directions, regardless of the angle of incidence of the incident light rays. A truly diffuse (Lambertian) reflective surface has the same luminance (appears to have the same brightness) from all viewpoints, regardless of the direction of the source relative to the surface. This type of reflection is associated with matte or "flat" surface treatments on objects, and is contrasted with specular reflectance. Most object surfaces exhibit a combination of specular and diffuse reflectance.
Dig	A small rough spot or short scratch on a polished surface, generally residuals of subsurface damage caused by grinding that did not polish out or from bubbles that opened up, whose dimensions are sufficient to be measured.
Distortion	A general term referring to the situation in which an image is not a true-to-scale reproduction of an object where the resultant image looks misshapen caused by a changing wedge angle between two window pane surfaces or by material inhomogeneities or irregularities in the optical surface.

Term	Definition
Field of View for Windows	All points through a window that can be viewed directly by at least one eye, given the combination of achievable eye, head, and body movement. The field of view is restricted by obstructions imposed by the facial structure around the eye and/or placed in front of the eye such as the crewmember's helmet if worn, mullions, structure, and/or other equipment. Achievable movement will vary for different flight phases and operational tasks and is dependent upon any constraints to movement that are extant such as being suited, seated, and/or restrained, and any g-loads present. With respect to line of sight phenomena such as contamination deposition and pluming, any point outboard of the window that is above the plane of the outer surface of the outer-most pane of the window port is considered within the field of view of the window.
Haze	The fogged appearance of a window or lens which occurs when light rays deviate from the incident beam by forward scattering as they pass through the window, measured as a percentage of the transmitted light that is deviated. Haze is caused by fine surface roughness, contamination, scratches, or internal inhomogeneities and inclusions.
Inclusions	A generic term used to denote the presence of all localized defects within bulk materials of essentially circular cross section including bubbles, seeds, striae knots, small stones, sand, and crystals. Inclusions scatter light in proportion to their area. Near an image plane, inclusions can be objectionable because of their visibility in images.
Index of refraction	The index of refraction or refractive index is a material property. It refers to the ratio of the speed of light in a vacuum with the phase velocity in the material. It is wavelength and temperature dependent. The index of refraction of vacuum is 1.0. The index of refraction of air is 1.0003. The index of refraction of fused silica varies from 1.469 to 1.455 across the visible spectrum at 20 C.
Open inclusions	Open inclusions are bulk material inclusions that have become exposed at the surface due to polishing or other processing steps. The bottom of an open inclusion is usually more pristine than a dig that typically is fractured. Hence, the depth of damage is usually less for an open inclusion than for a dig.
Optical path length	Optical path length (OPL) refers to the path that light actually travels within a medium and is described as follows: $OPL = nt$ where n is the index of refraction of the material or medium and t is the physical length of the path. OPL is wavelength dependent.

Term	Definition
Protective Cover	<p>An internal non-pressure containing, transparent sheet or pane, usually of a different material than the window panes such as acrylic or other material, intended to protect the underlying window pressure and/or protective pane(s) from incidental crew contact. A protective cover is normally not an integral part of the window assembly and in such cases where it is not an integral part of the window assembly, a protective cover has at least Category D optical properties except with respect to wavefront and in cases where a protective cover also serves as a window filter. In such cases with respect to wavefront the transmitted wavefront error for protective covers is at least 1 wave over any 25 mm (~1 in) diameter sub-aperture within the central 80% (minimum) of the physical area of the window where the reference wavelength is 632.8 nm (excluding flight loads, pressure loads, and temperature gradients) and where a protective cover also acts as a window filter, the transmittance for hazardous, non-ionizing radiation wavelengths is reduced to safe levels. Non-integral or removable protective covers are easily removable without the use of tools in less than 10 seconds by one crew member and reinstallable in less than 10 seconds without the use of tools by one crew member or operable from fully closed to fully open in less than 10 seconds without the use of tools by one crew member and from fully open to fully closed in less than 10 seconds without the use of tools by one crew member. Non-integral protective panes can be considered temporary; that is, replaceable after some period of time after which their optical quality has degraded below the category level for which they were designed.</p>
Protective Pane	<p>Either an external or internal, non-pressure containing, transparent pane that is intended to protect the underlying window pressure pane(s) from natural and induced environmental degradation such as contamination, erosion, debris impacts, and incidental crew contact. A protective pane is normally considered an integral part of the window assembly and is at least of the same optical quality as the window pane(s) it protects. Non-integral protective panes are easily removable from the window assembly and reinstallable onto the window assembly within 1 hour EVA or 10 minutes IVA with the use of a minimal set of EVA tools (EVA) or standard hand tools (IVA) by one crew member. Protective panes can be considered temporary; that is, replaceable after some period of time after which their optical quality has degraded below the category level for which they were designed. External protective panes can be considered sacrificial.</p>

Term	Definition
Quartz Crystal Microbalance (QCM)	A device that uses a piezoelectric quartz crystal to detect the presence of contamination. A QCM compares the resonance frequency of a shielded quartz crystal, which remains contamination free, with one that is exposed to the environment and experiences deposition of contamination. By calibrating the QCM, the amount of mass deposition can be determined.

Term	Definition															
Rayleigh Limit	<p>An ideal window would induce no errors into a transmitting wavefront. Wavefront error (optical path difference) degrades image quality when subsequently imaged by an optical system. The Rayleigh Limit addresses how much wavefront error can be introduced by a window and not affect the image quality of a near diffraction limited optical system viewing through it. The Rayleigh Limit allows for not more than 1/4 wave peak-to-valley optical path difference (OPD) with the reference wavelength typically being 632.8 nm. If the total optical aberrations are limited to less than one Rayleigh Limit then smaller aperture systems (standard cameras, binoculars etc) will perform well. When an optical system images a point source (like a star), a diffraction limited (perfect) system will produce an image of the point source, but because of diffraction, the image will have a central bright disc and a series of concentric rings surrounding the central disk (called an Airy disc). In a perfect system, 84% of the energy will be located in the central disk, and 16% of the energy in the surrounding rings. As the wavefront error is increased, there becomes a noticeable shift of energy from the central disc to the rings. This energy shift makes the image start looking blurry. For small amounts of wavefront error, the energy distribution is as follows:</p> <table border="1" data-bbox="500 1016 1369 1339"> <thead> <tr> <th data-bbox="500 1016 954 1123">Wavefront Error ($\lambda = 632.8\text{nm}$)</th> <th data-bbox="954 1016 1198 1123">Energy in Central Disk</th> <th data-bbox="1198 1016 1369 1123">Energy in Rings</th> </tr> </thead> <tbody> <tr> <td data-bbox="500 1123 954 1178">Perfect Lens (OPD = 0)</td> <td data-bbox="954 1123 1198 1178">0.84</td> <td data-bbox="1198 1123 1369 1178">0.16</td> </tr> <tr> <td data-bbox="500 1178 954 1232">OPD = $\lambda/16$</td> <td data-bbox="954 1178 1198 1232">0.83</td> <td data-bbox="1198 1178 1369 1232">0.17</td> </tr> <tr> <td data-bbox="500 1232 954 1287">OPD = $\lambda/8$</td> <td data-bbox="954 1232 1198 1287">0.8</td> <td data-bbox="1198 1232 1369 1287">0.2</td> </tr> <tr> <td data-bbox="500 1287 954 1339">OPD = $\lambda/4$ [one Rayleigh Limit]</td> <td data-bbox="954 1287 1198 1339">0.68</td> <td data-bbox="1198 1287 1369 1339">0.32</td> </tr> </tbody> </table> <p>It is apparent that the amount of aberration corresponding to one Rayleigh Limit does cause a small but appreciable change in the characteristics of the image. However, for most small aperture systems, particularly cameras, the performance is more than acceptable. For larger aperture systems such as for telescopes and other high performance systems, the Rayleigh Limit is not sufficient to ensure that noticeable degradation is not introduced by the window. Hence, Category A windows require an OPD of no more than 1/10th wave.</p> <p>The Rayleigh Limit originated from a famous paper by A. Marechal titled "Etude des effets combines de la diffraction et des aberrations geometriques sur l'image d'un point lumineux", Rev. Opt. 26:257 (1947). The Rayleigh Limit is also discussed in many textbooks including "Modern Optical Engineering" by W. Smith.</p>	Wavefront Error ($\lambda = 632.8\text{nm}$)	Energy in Central Disk	Energy in Rings	Perfect Lens (OPD = 0)	0.84	0.16	OPD = $\lambda/16$	0.83	0.17	OPD = $\lambda/8$	0.8	0.2	OPD = $\lambda/4$ [one Rayleigh Limit]	0.68	0.32
Wavefront Error ($\lambda = 632.8\text{nm}$)	Energy in Central Disk	Energy in Rings														
Perfect Lens (OPD = 0)	0.84	0.16														
OPD = $\lambda/16$	0.83	0.17														
OPD = $\lambda/8$	0.8	0.2														
OPD = $\lambda/4$ [one Rayleigh Limit]	0.68	0.32														

Term	Definition
Reflectance	The fraction or percentage of incident light or other type of wave at a specified wavelength that is reflected from a surface (see also specular and diffuse reflectance).
Scratches	Any marking or tearing of the native surface material, substrate, surface coating, or surface laminate along the line of the surface appearing as though caused by the movement of a rough or a hard, sharp object which leaves a roughened depression. Scratches scatter light and can introduce visual and image distortion, and would be objectionable if near an image plane.
Seeds	A term used to denote a gaseous inclusion having an extremely small diameter in glass.
Specular Reflection	The perfect, mirror-like reflection of a wave such as light from a surface, in which the light from a single incoming direction is reflected into a single outgoing direction as described by Snell's Law ($\theta_i = \theta_r$). Diffuse reflection, on the other hand, refers to light that is reflected in a broad range of directions (see diffuse reflectance). The most familiar example of the distinction between specular and diffuse reflection in the case of light waves would be glossy and matte paints or photo prints. While both finishes exhibit a combination of specular and diffuse reflectance, glossy paints and photo prints have a greater proportion of specular reflectance and matte paints and photo prints have a greater proportion of diffuse reflectance. Anti-reflection coatings reduce the amount of light that is reflected from a given surface. Reflectance for an uncoated glass surface is ~4%, which yields ~8% for the two surfaces of a single pane. Antireflective coatings can reduce the total reflectance to ~2% or less.
Striae	Spatially short range variations (0.1 mm to 2 mm) in the index of refraction of a transparent material, usually of glass especially when formed into panes. Striae are different from spatially global index of refraction inhomogenieties that affect the complete material piece. Striae induce wavefront errors.
Transmittance	The fraction or percentage of incident light at a specified wavelength that passes through a medium.
Wavefront	Light travels as an electromagnetic wave. A wavefront is defined as a surface joining all adjacent points on a wave that have the same phase.

Term	Definition
Wavefront Error	<p>Wavefront error is the total optical path difference induced into a wavefront with respect to the wavelength of light, usually referenced to a HeNe laser wavelength of 632.8 nm. For planar waves, wavefront error occurs when the wavefront is distorted such that an individual wavefront is no longer in phase. This occurs when different parts of the wavefront travel different optical path lengths. In an ideal window, a planar wave will pass through it such that the optical path length at each point on the window is the same, and the wavefront retains the same phase.</p> <p>Wavefront error is aperture dependent. In an imperfect window, the wavefront is distorted; that is, the phase is not maintained. Wavefront error can be distorted by surface imperfections (the window is not 'flat') or by material inhomogeneities (the index of refraction varies across the window).</p>
Wedge	The angle formed by and between the two surfaces of an individual window pane.
Window	A non-electronic means for direct through the hull viewing using a transparent material; the same as and used interchangeably with window port.
Window Cover	See Protective Cover
Window filter	<p>An internal, non-pressure containing, transparent sheet or pane, usually of a different material than the window panes such as polycarbonate or other material, intended to filter non-ionizing radiation hazards to safe levels. A window filter is not considered an integral part of the window assembly. Window filters are easily removed and reinstalled without the use of tools by one crew member. A window filter may also serve as a protective cover.</p>
Window port	The finished assembly including the frame structure (includes all gaskets, bolts, spacers, and other such parts) and all window panes that would normally be used at a specific location with any protective panes, permanent coatings, polycarbonate films, or laminates applied or in place.
Window shade	<p>Usually an internal, non-pressure containing, opaque sheet intended to block external light from entering the interior of a crew cabin. A window shade may or may not be integral part of the window assembly. Nonintegral window shades are easily removable and reinstallable without the use of tools in less than 10 seconds by one crew member. Window shades that are an integral part of the window assembly can also act as window shutters.</p>
Window shutter	<p>An internally and remotely operable, external cover intended to prevent natural and induced environmental degradation of the outboard-most window pane (e.g.: contamination, erosion, and impacts) with open and close indicators that are readable from the remote operating location. Window shutters can be operated through their full range of motion in less than 10 seconds and can serve as window shades.</p>

For research and technical assistance contact the authors:

Mario Runco, Jr. (Astronaut: STS-44, 54, & 77)
Lead, Spacecraft Window Optics and Utilization
Human Exploration Science Office (KX)
Astromaterials Research and Exploration Sciences
Directorate (KA) and
Habitability and Human Factors Branch (SF3)
Habitability and Environmental Factors Division (SF)
Space and Life Sciences Directorate (SA)

Lyndon B. Johnson Space
Center
2101 NASA Road 1
Houston, Texas 77058-3696
mario.runco-1@nasa.gov
(281) 244-8882

Karen P. Scott, Ph.D., (The University of Arizona,
Optical Sciences Center, 1998)
Senior Engineering Specialist

The Aerospace Corporation
Author of over 30 scientific
and technical papers on
spacecraft window design
karen.p.scott@aero.org
(281) 283-6457

Valuable assistance and support is in helping to prepare this document is gratefully acknowledged from:

The Late David Amsbury (JSC)
Janis Connolly (JSC-SF3)
Dean B. Eppler (SAIC-JSC-ZX)
Kamlesh P. Lulla (JSC-KX)
Gary A. Fleming (LRC)
Howard A. Wagner (JSC)
Charles Allton (JSC)

Susan K. Runco (JSC-KX)
David Warren (Aerospace Corp.)
Stephen K. Wilcken (The Boeing Corp.)
W. Thomas Morrow (JSC)
Mary J. Taylor (Bastion Technologies-JSC)
Ricardo J. Villareal (JSC)
Paul March (Barrios Technologies-JSC)
