

# Probabilistic Assessment of Treatment Success for Hypobaric Decompression Sickness

*Johnny Conkin, PhD<sup>1</sup>*

*Andrew F.J. Abercromby, PhD<sup>2</sup>*

*Joseph P. Dervay, MD<sup>3</sup>*

*Alan H. Feiveson, PhD<sup>3</sup>*

*Michael L. Gernhardt, PhD<sup>3</sup>*

*Jason R. Norcross, MS<sup>2</sup>*

*Robert Ploutz-Snyder, PhD<sup>1</sup>*

*James H. Wessel, III, MS<sup>2</sup>*

<sup>1</sup>*Universities Space Research Association, Houston, TX 77058*

<sup>2</sup>*Wyle Science, Technology & Engineering Group, Houston, TX 77058*

<sup>3</sup>*NASA Johnson Space Center, Houston, TX 77058*

## NASA STI Program ... in Profile

Since its founding, NASA has been dedicated to the advancement of aeronautics and space science. The NASA scientific and technical information (STI) program plays a key part in helping NASA maintain this important role.

The NASA STI program operates under the auspices of the Agency Chief Information Officer. It collects, organizes, provides for archiving, and disseminates NASA's STI. The NASA STI program provides access to the NASA Aeronautics and Space Database and its public interface, the NASA Technical Reports Server, thus providing one of the largest collections of aeronautical and space science STI in the world. Results are published in both non-NASA channels and by NASA in the NASA STI Report Series, which includes the following report types:

- **TECHNICAL PUBLICATION.** Reports of completed research or a major significant phase of research that present the results of NASA Programs and include extensive data or theoretical analysis. Includes compilations of significant scientific and technical data and information deemed to be of continuing reference value. NASA counterpart of peer-reviewed formal professional papers but has less stringent limitations on manuscript length and extent of graphic presentations.
- **TECHNICAL MEMORANDUM.** Scientific and technical findings that are preliminary or of specialized interest, e.g., quick release reports, working papers, and bibliographies that contain minimal annotation. Does not contain extensive analysis.
- **CONTRACTOR REPORT.** Scientific and technical findings by NASA-sponsored contractors and grantees.

- **CONFERENCE PUBLICATION.** Collected papers from scientific and technical conferences, symposia, seminars, or other meetings sponsored or co-sponsored by NASA.
- **SPECIAL PUBLICATION.** Scientific, technical, or historical information from NASA programs, projects, and missions, often concerned with subjects having substantial public interest.
- **TECHNICAL TRANSLATION.** English-language translations of foreign scientific and technical material pertinent to NASA's mission.

Specialized services also include organizing and publishing research results, distributing specialized research announcements and feeds, providing information desk and personal search support, and enabling data exchange services.

For more information about the NASA STI program, see the following:

- Access the NASA STI program home page at <http://www.sti.nasa.gov>
- E-mail your question to [help@sti.nasa.gov](mailto:help@sti.nasa.gov)
- Fax your question to the NASA STI Information Desk at 443-757-5803
- Phone the NASA STI Information Desk at 443-757-5802
- Write to:  
STI Information Desk  
NASA Center for AeroSpace Information  
7115 Standard Drive  
Hanover, MD 21076-1320

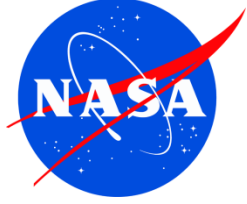

# Probabilistic Assessment of Treatment Success for Hypobaric Decompression Sickness

*Johnny Conkin, PhD<sup>1</sup>*

*Andrew F.J. Abercromby, PhD<sup>2</sup>*

*Joseph P. Dervay, MD<sup>3</sup>*

*Alan H. Feiveson, PhD<sup>3</sup>*

*Michael L. Gernhardt, PhD<sup>3</sup>*

*Jason R. Norcross, MS<sup>2</sup>*

*Robert Ploutz-Snyder, PhD<sup>1</sup>*

*James H. Wessel, III, MS<sup>2</sup>*

<sup>1</sup>*Universities Space Research Association, Houston, TX 77058*

<sup>2</sup>*Wyle Science, Technology & Engineering Group, Houston, TX 77058*

<sup>3</sup>*NASA Johnson Space Center, Houston, TX 77058*

Available from:

NASA Center for AeroSpace Information  
7115 Standard Drive  
Hanover, MD 21076-1320

National Technical Information Service  
5301 Shawnee Road  
Alexandria, VA 22312

Available in electric form at <http://ston.jsc.nasa.gov/collections/TRS>

Johnny Conkin, PhD, Andrew F.J. Abercromby, PhD, Joseph P. Dervay, MD, Alan H. Feiveson, PhD,  
Michael L. Gernhardt, PhD, Jason R. Norcross, MS, Robert Ploutz-Snyder, PhD, and James H. Wessel, III, MS.

Universities Space Research Association  
3600 Bay Area Boulevard, Houston, TX 77058-2769  
[johnny.conkin-1@nasa.gov](mailto:johnny.conkin-1@nasa.gov)  
281-244-1121 office  
281-483-3058 fax

Wyle Science, Technology & Engineering Group  
1290 Hercules Avenue, Houston, TX 77058  
[andrew.abercromby-1@nasa.gov](mailto:andrew.abercromby-1@nasa.gov)  
281-532-5091

NASA Johnson Space Center  
Mail Code SD2  
2100 NASA Parkway, Houston, TX 77058  
[joseph.p.dervay@nasa.gov](mailto:joseph.p.dervay@nasa.gov)  
281-483-7302

NASA Johnson Space Center  
Mail Code SK311  
2100 NASA Parkway, Houston, TX 77058  
[alan.h.feiveson@nasa.gov](mailto:alan.h.feiveson@nasa.gov)  
281-483-6603

NASA Johnson Space Center  
Mail Code EA321  
2100 NASA Parkway, Houston, TX 77058  
[michael.l.gernhardt@nasa.gov](mailto:michael.l.gernhardt@nasa.gov)  
281-244-8977

Wyle Science, Technology & Engineering Group  
1290 Hercules Avenue, Houston, TX 77058  
[jason.norcross-1@nasa.gov](mailto:jason.norcross-1@nasa.gov)  
281-483-7114

Universities Space Research Association  
3600 Bay Area Boulevard, Houston, TX 77058-2769  
[robert.ploutz-snyder-1@nasa.gov](mailto:robert.ploutz-snyder-1@nasa.gov)  
281-483-6296

Wyle Science, Technology & Engineering Group  
1290 Hercules Avenue, Houston, TX 77058  
[james.wessel-1@nasa.gov](mailto:james.wessel-1@nasa.gov)  
281-244-1128

## Abstract

The Hypobaric Decompression Sickness (DCS) Treatment Model links a decrease in computed bubble volume from increased pressure ( $\Delta P$ ), increased oxygen ( $O_2$ ) partial pressure, and passage of time during treatment to the probability of symptom resolution [P(symptom resolution)]. The decrease in offending volume is realized in 2 stages: a) during compression via Boyle's law and b) during subsequent dissolution of the gas phase via the  $O_2$  window. We established an empirical model for the P(symptom resolution) while accounting for multiple symptoms within subjects. The data consisted of 154 cases of hypobaric DCS symptoms along with ancillary information from tests on 56 men and 18 women. Our best estimated model is  $P(\text{symptom resolution}) = 1 / (1 + \exp(-(\ln(\Delta P) - 1.510 + 0.795 \times \text{AMB} - 0.00308 \times T_s) / 0.478))$ , where  $\Delta P$  is pressure difference (psid);  $\text{AMB} = 1$  if ambulation took place during part of the altitude exposure, otherwise  $\text{AMB} = 0$ ; and  $T_s$  is the elapsed time in mins from the start of altitude exposure to recognition of a DCS symptom. To apply this model in future scenarios, values of  $\Delta P$  as inputs to the model would be calculated from the Tissue Bubble Dynamics Model based on the effective treatment pressure:  $\Delta P = P_2 - P_1 \mid = P_1 \times V_1 / V_2 - P_1$ , where  $V_1$  is the computed volume of a spherical bubble in a unit volume of tissue at low pressure  $P_1$  and  $V_2$  is computed volume after a change to a higher pressure  $P_2$ . If 100% ground-level  $O_2$  (GLO) was breathed in place of air, then  $V_2$  continues to decrease through time at  $P_2$  at a faster rate. This calculated value of  $\Delta P$  then represents the effective treatment pressure at any point in time. Simulation of a "pain-only" symptom at 203 min into an ambulatory extravehicular activity (EVA) at 4.3 psia on Mars resulted in a P(symptom resolution) of 0.49 (0.36 to 0.62 are 95% confidence limits) on immediate return to 8.2 psia in the Multi-Mission Space Exploration Vehicle. The P(symptom resolution) increased to near certainty (0.99) after 2 h of GLO at 8.2 psia or with less certainty on immediate pressurization to 14.7 psia [0.90 (0.83 – 0.95)]. Given the low probability of DCS during EVA and the prompt treatment of a symptom with guidance from the model, the symptom and the gas phase are likely to resolve with minimal resources and minimal impact to astronaut health, safety, and productivity.

## Executive Summary

Decompression sickness (DCS) is an occupational hazard for astronauts as long as extravehicular activity (EVA) is performed at spacesuit pressure less than tissue inert gas tension. Efforts to eliminate DCS in astronauts through engineering control of the habitat atmosphere to minimize atmospheric nitrogen partial pressure will reduce the probability of DCS [P(DCS)] and severity of symptoms related to evolved gas. Prudent planning requires that DCS treatment resources be provided for exploration-class missions where EVAs will be numerous and energetic, and where a return to definitive medical care is not possible.

Two statistical regression models are described that enable mission managers to quantify the P(DCS) associated with future EVAs and to quantify the probability of symptom resolution [P(symptom resolution)] given options for treatment. A biophysical Tissue Bubble Dynamics Model that models bubble growth and dissolution is linked to the 2 probability regression models. The regression models are quantitative descriptions of data collected during NASA-funded research on DCS from 1983 to 2014, based on 969 altitude exposures from 497 subjects that evaluated 47 different denitrogenation protocols preceding simulated EVAs in hypobaric chambers.

A user of this “system” computes the P(DCS) and P(symptom resolution) given information about the denitrogenation (prebreathe) protocol, the suit pressure, the time to onset of a symptom during EVA, body mass index and age of the astronaut, and whether ambulation occurred during the EVA. The ambulation status is an important variable in the regressions, distinguishing between ambulation during EVA on a planetary surface and nonambulation during EVA in space. The user can also compute the P(DCS without symptom resolution), which combines information from P(DCS) and P(symptom resolution).

Treatment is effective in achieving a high P(symptom resolution) when treatment starts shortly after a symptom is recognized. Effective treatment is achieved through the application of pressure during repressurization of the suit to the habitat pressure, an increase in habitat pressure, additional pressurization of the suit above habitat pressure, and the use of 100% oxygen (O<sub>2</sub>) breathing to accelerate the natural process of bubble dissolution. Combinations of treatment pressure and 100% O<sub>2</sub> breathing through time to achieve  $\geq 0.75$  P(symptom resolution) at the lower 95% confidence limit is proposed as a requirement to establish minimum treatment resources that ensure a successful treatment outcome for exploration-class EVAs. A recommendation based on the P(DCS without symptom resolution) awaits further analysis. Adjunctive pharmaceutical and supportive critical-care therapy are also necessary, even given a low probability of serious DCS.

Options for DCS treatment after exploration-class EVAs must be based on evidence. An evidence-based approach ultimately matches the most effective treatment to the anticipated risks. Providing medical treatment at remote locations is costly and has an impact on the success of the mission, so it must be effective. The “system” described in this communication meets the requirement of an evidence-based approach.

## Table of Contents

Abstract .....	vi
Executive Summary .....	vii
Tables .....	x
Figures .....	xi
Abbreviations and Acronyms .....	xiii
Diver, Aviator, and Astronaut DCS .....	1
Hyperbaric DCS and Hypobaric DCS Are Different .....	2
NASA Classification of DCS .....	3
Type I DCS .....	3
Type II DCS .....	4
Cutis Marmorata .....	6
Arterial Gas Embolism .....	6
Air Diver Treatment Tables .....	6
USN Hyperbaric Oxygen TT V and Extended TT VI .....	7
USAF Hyperbaric Oxygen TT V and Extended TT VI .....	7
Ground-level Oxygen .....	7
Evolving Treatment Option: USAF TT VIII .....	8
Current Astronaut Treatment .....	8
Bends Treatment Apparatus .....	9
Adjunctive Pharmaceutical and Emergency Care Interventions .....	9
NASA DCS Data .....	10
$\Delta P$ in Air Force DCS Data .....	11
USAF Data Compared with NASA Data .....	13
NASA Symptom Data .....	14
Individual Perception of Pain .....	18
Symptom Intensity and P(DCS) .....	19
NASA Symptom Resolution Data .....	22
Symptoms .....	24
$\Delta P$ .....	26
HBO Treatment and Recurrent Symptoms .....	32
P(symptom resolution) .....	34
Computing Effective Treatment Pressure .....	36
O <sub>2</sub> Window and Bubble Dissolution .....	42
Tissue Bubble Dynamics Model Details .....	48
Denitrogenation .....	49
Example Applications of the TBDM for Treatment Scenarios .....	50
DCS Survival Model .....	51
Log-logistic Accelerated Survival Model for DCS with BGI .....	52
Accelerated DCS Survival Model .....	55
Accelerated VGE Survival Model .....	56
Hypobaric DCS Treatment Model .....	60
Simulations to Estimate P(symptom resolution) .....	65
Overall Risk Model for Future Missions .....	67
Time to Resolve Gas Phase .....	70



Partial Validation of Hypobaric DCS Treatment Model .....	72
Combined NASA and USAF Data on Symptom Resolution .....	73
Treatment Model Validation – Combined NASA and USAF Data .....	80
Visual Validation .....	80
Discussion .....	84
Acknowledgments .....	88
References .....	89
Appendix I: Aeromedical Flight Rule B13-259 .....	94
Appendix II: ISS Decompression Sickness Treatment Flow .....	97
Appendix III: Decompression Sickness Treatment Database Headings .....	104
Appendix IV: Case Descriptions of Hypobaric Decompression Sickness .....	108
Appendix V: Prebreathe and Test Details .....	191
Appendix VI: Summary of Protocols from 1982 to 2009 .....	217

## Tables

I.	Signs and Symptoms of Serious DCS .....	5
II.	Literature Data on Symptom Resolution .....	13
III.	NASA Data on Symptom Resolution .....	23
IV.	NASA Hyperbaric Oxygen Treatments .....	33
V.	Estimated O <sub>2</sub> Windows Related to MMSEV DCS Treatment .....	44
VI.	Regression Details about DCS Survival Model .....	55
VII.	Observed and Predicted DCS in Selected Large-Sample Protocols .....	56
VIII.	Regression Details about VGE Survival Model .....	58
IX.	Observed and Predicted VGE in Selected Large-Sample Protocols .....	59
X.	P(DCS) and P(VGE) for MMSEV .....	59
XI.	Regression Details about Symptom Resolution Model (No Dependency) .....	61
XII.	Regression Details about Symptom Resolution Model (Dependency) .....	61
XIII.	Comparison of Ambulatory and Nonambulatory Symptom Data .....	63
XIV.	Validation Data for Hypobaric DCS Treatment Model .....	73
XV.	Combined NASA and USAF Data on Symptom Resolution .....	74
XVI.	Regression Details about Symptom Resolution Model in Combined NASA and USAF Data (N = 1,707) .....	76
XVII.	Regression Details about Symptom Resolution Model in Combined NASA and USAF Data (N = 1,361) .....	78

## Figures

1. Cumulative percentage of symptoms. ....	12
2. Regression results of symptom resolution during repressurization. ....	14
3. Histogram distribution of symptom onset times. ....	15
4. Empirical cumulative distribution of symptom onset times. ....	16
5. Cumulative proportion of 138 symptoms that resolved during repressurization and at site pressure. ....	17
6. Incidence and mean grade of altitude DCS. ....	19
7. Association of maximum symptom intensity with symptom onset time, for 128 symptoms. ....	20
8. Maximum intensity score from 79 of 138 symptoms associated with the observed $\Delta P$ during repressurization to site pressure. ....	21
9. Number of 220 symptoms associated with group DCS incidence from 40 protocols. ..	22
10. Histogram distribution of age in 119 men and women with DCS. ....	23
11. Locations of 203 symptoms of Type I DCS. ....	24
12. Counts of 456 symptom attributes. ....	25
13. Type II DCS symptom attributes. ....	26
14. Relationship between the report of DCS symptoms and the $\Delta P$ for symptom resolution during repressurization to site pressure. ....	27
15. Relationship between the duration of 134 symptoms and the $\Delta P$ for symptom resolution during repressurization to site pressure. ....	28
16. Cumulative proportion of 138 symptoms that resolved at the given $\Delta P$ during or shortly after repressurization to site pressure. ....	29
17. Cumulative proportion of 195 symptoms that resolved at the given $\Delta P$ , including symptoms that resolved at the test altitude. ....	30
18. Cumulative proportion of 158 symptoms that resolved at the given $\Delta P$ , including symptoms that required HBO treatment. ....	31
19. P(symptom resolution) based on 158 symptoms that resolved at a $\Delta P$ between 0 and 37.1 psid. ....	35
20. P(symptom resolution) based on 138 symptoms that resolved at a $\Delta P$ between 0 and 10.4 psid. ....	36
21. Observed $\Delta P$ to resolve 138 symptoms compared to the computed $\Delta P$ based on Eq. 9. ....	38
22. Observed $\Delta P$ to resolve 138 symptoms compared to the computed $\Delta P$ based on Eq. 12. ....	39
23. Comparison of astronaut and diver repressurizations. ....	41
24. Examples of bubble growth and dissolution using the TBDM. ....	42
25. Relationship between $P_{Wnorm(1)}$ and BGI dissolution time. ....	48
26. Six simulated treatment cases in the MMSEV. ....	50
27. Cumulative proportion of DCS increased as exposure time increased in 47 protocols that totaled 969 altitude exposures. ....	52
28. Survival analysis results with BGI as the only explanatory variable for DCS failure time. ....	54
29. $P(DCS)_t$ as a function of time and maximum BGI in steps of 5 BGI units. ....	54
30. Cumulative proportion of VGE increased as exposure time increased in 40	

protocols that totaled 842 altitude exposures. ....	57
31. Comparison of the P(symptom resolution) based on 158 symptoms that resolved at a $\Delta P$ between 0 and 37.1 psid. ....	60
32. P(symptom resolution) for the ambulatory condition. ....	62
33. P(symptom resolution) for the nonambulatory condition. ....	63
34. Simulation with ambulatory (upper curve) and nonambulatory (lower curve) subjects without accounting for dependency among symptoms, where $T_s = 120$ min. ..	64
35. Simulation with ambulatory (upper curve) and nonambulatory (lower curve) subjects accounting for dependency among symptoms, where $T_s = 120$ min. ....	65
36. Simulation of BGI growth at 4.3 psia and dissolution at 14.7 psia given a short PB with $T_s = 60$ min and 66 min from start of ascent. ....	66
37. Application of Eq. 23 given a future hypothetical EVA similar to the example shown and described by Fig. 36. ....	68
38. Realistic simulation scenario of an EVA from the MMSEV. ....	69
39. Comparison of 2 repressurizations. ....	70
40. Four simulated treatment cases in the MMSEV. ....	72
41. Cumulative proportion of 1,709 symptoms from NASA and USAF that resolved at the given $\Delta P$ , the empirical CDF $[F_n(\Delta P)]$ . ....	74
42. P(symptom resolution) based on 1,709 symptoms from USAF and NASA that resolved at a $\Delta P$ between 0 and 37.9 psid. ....	75
43. P(symptom resolution) based on 1,707 symptoms that included 82 HBO treatments for symptoms at site pressure. ....	77
44. P(symptom resolution) based on 1,361 symptoms that included 36 HBO treatments for symptoms at site pressure. ....	79
45. P(symptom resolution) for a given $\Delta P$ is associated with the pressure at the onset of a symptom ( $P_1$ ). ....	80
46. The P(symptom resolution) with X-symbols compared to the empirical CDF $[F_n(\Delta P)]$ of 876 symptoms, with O-symbols from the training set that resolved at the given $\Delta P$ . ....	81
47. The observed empirical CDF $[F_n(\Delta P)]$ minus the predicted P(symptom resolution) over the range of $\Delta P$ from the 6-parameter treatment model, optimized to 876 symptoms in the training set. . ....	82
48. The P(symptom resolution) with X-symbols compared to the empirical CDF $[F_n(\Delta P)]$ of 831 symptoms, with O-symbols from the validation set that resolved at the given $\Delta P$ . ....	83
49. The observed empirical CDF $[F_n(\Delta P)]$ minus the predicted P(symptom resolution) over the range of $\Delta P$ from the 6-parameter treatment model, optimized to 831 symptoms in the validation set. ....	84

## Abbreviations and Acronyms

AGE	arterial gas emboli
AFB	Air Force Base
ATA	atmospheres absolute pressure
BGI	bubble growth index from the Tissue Bubble Dynamics Model
BMI	body mass index
BTA	Bends Treatment Apparatus
BTPD	gas volume expressed under body temperature (37°C), ambient pressure, and dry-gas conditions
BTPS	gas volume expressed under body temperature (37°C), ambient pressure, and saturated water vapor (47 mmHg) conditions
CDF	cumulative distribution function
CL	confidence limit(s)
CM	cutis marmorata
CMO	Crew Medical Officer
CNS	central nervous system
CO <sub>2</sub>	carbon dioxide
DCS	decompression sickness
$\Delta P$	pressure difference defined as the pressure at symptom resolution ( $P_2$ ) minus the altitude test pressure ( $P_1$ ), in units of psid
$\Delta P_{ss}$	supersaturation pressure
$\Delta V$	difference in gas volumes between two conditions that effect gas volumes
EVA	extravehicular activity
$F_n(\Delta P)$	empirical CDF of symptom resolution as a function of $\Delta P$
$F_n(t)$	empirical CDF of DCS as a function of exposure time t
fsw	feet of sea water
GLO	ground-level oxygen
h	hour(s)
HBO	hyperbaric oxygen
H <sub>2</sub> O	water
ISS	International Space Station
JSC	Johnson Space Center
LL	log likelihood
ln	natural logarithm
$\mu\text{m}$	micrometer
mHz	megahertz
min	minute
MO	medical officer
MMSEV	Multi-Mission Space Exploration Vehicle
mmHg	millimeters of mercury (unit of pressure)
NASA	National Aeronautics and Space Administration
N <sub>2</sub>	nitrogen
O <sub>2</sub>	oxygen
PB	prebreathe

$P_B$	any ambient pressure in units of psia, and $P_B = P_1$ when ambient pressure equals specific altitude test pressure
$P_{\text{bub}N_2}$	partial pressure of nitrogen in a bubble
$P_{\text{bub}X}$	bubble partial pressure of gas species x
$P(\text{DCS})$	probability of decompression sickness - general
$P(\text{DCS})_t$	probability of decompression sickness [ $P(T < t)$ ] - specific
PFO	patent foramen ovale
$P_{H_2O}$	partial pressure of water vapor
PRP	Prebreathe Reduction Program
psia	pounds per square inch absolute
psid	pounds per square inch delta
$P(\text{symptom resolution})$	probability of symptom resolution
$P_{\text{tis}N_2}$	tissue nitrogen tension
$P_{\text{tis}O_2}$	tissue oxygen tension
$P_{\text{tis}CO_2}$	tissue carbon dioxide tension
$P_{\text{tis}H_2O}$	tissue water vapor tension (47 mmHg at 37°C)
$P_{\text{tis}X}$	tissue tension of gas species x
$P_t$	computed total tissue inert gas tension throughout the exposure when computing $dr/dt$ when more than one inert gas is in breathing mixture, or equivalent to $P_{\text{tis}N_2}$ when nitrogen is the only inert gas in the breathing mixture
$P(\text{VGE})$	probability of venous gas emboli - general
$P(\text{VGE})_t$	probability of venous gas emboli [ $P(T < t)$ ] - specific
Q	probability of having DCS occur and fail to respond to treatment given a $\Delta P$
$r_c$	critical radius
SD	standard deviation
STPD	gas volume expressed under standard temperature (0°C), 1 ATA pressure, and dry-gas conditions
TBDM	Tissue Bubble Dynamics Model
TR	tissue ratio: $P_{\text{tis}N_2} / P_B$
TT	Treatment Table, a prescribed HBO treatment protocol
USAF	United States Air Force
USN	United States Navy
VGE	venous gas emboli

## Diver, Aviator, and Astronaut DCS

When a diver returns from a hyperbaric environment, or an aviator or astronaut travels to a hypobaric environment, the amount of inert gas in excess of what can be held in solution at the new, lower pressure has the potential to come out of solution to form gas spaces that can displace or otherwise damage tissues. Displacement of tissue by trapped gas spaces or disruption of metabolic function due to embolic obstruction of blood flow can cause a wide range of signs and symptoms. The many signs and symptoms that are consequences of evolved gas and a review of treatment options for afflicted divers, aviators, and astronauts are summarized below and in several publications (Norfleet 2008, Stepanek & Webb 2008, Stepanek 2002, Krause & Pilmanis 2000, Ryles & Pilmanis 1996, Muehlberger *et al.* 2004, Conkin *et al.* 2003, Jersey *et al.* 2010, Moon & Gorman 2003).

A fundamental axiom about decompression sickness (DCS) is that a transient gas supersaturation exists in a tissue region; the sum of all gas partial pressures in that region is greater than the ambient pressure opposing the release of the gas. Expressed as an equation, supersaturation exists when  $\Delta P_{ss}$  is positive:

$$\Delta P_{ss} = \left( \sum_{i=1}^n P_i - P_B \right) \quad \text{Eq. 1}$$

where  $P_i$  is the dissolved gas tension of the  $i^{\text{th}}$  gas of  $n$  species in the tissue and  $P_B$  is the ambient pressure after depressurization. The potential for bubble nucleation and rate of bubble growth are related to the magnitude of the time-dependent supersaturation.

While gas supersaturation in the tissue is not in itself harmful, it is a thermodynamically unstable condition between the tissue and the surrounding environment. The difference between tissue gas tension and ambient pressure can be resolved with a phase transition, and some of the excess mass (moles) of gas in the form of bubbles may be accommodated by the tissue and cause no symptoms. However, when a gas space is formed due to partial or complete desaturation of a supersaturated tissue, there is a probability of DCS [P(DCS)] (Weathersby *et al.* 1984). A necessary but insufficient condition for DCS is the formation of a gas phase in the tissue. The assumption that pain results from the deformation of tissue past a critical point by evolved gas may not account for symptoms other than the pain from pain-only DCS, but evolved gas is certainly the primary insult for all subsequent signs and symptoms. It is not the presence or even the volume of evolved gas in the tissue that is important in pain-only DCS; it is the pressure difference between the gas space and the tissue that is important. The pressure difference is termed “deformation pressure ( $\delta$ )” by Nims (1951). Reducing  $\delta$  is the key to effective symptom treatment in most cases. For example, inflation of a pressure cuff around a joint is effective to resolve a symptom, as compression of the gas phase through Boyle’s law reduces the  $\delta$  between the gas phase and sensory nerves in the joint. Resolution of a symptom caused by prolonged ischemic damage due to a gaseous embolus would also benefit from the application of pressure so as to reestablish perfusion. Longer term recovery of ischemic-related injury would benefit from intervals of 100% oxygen ( $O_2$ ) breathing and appropriate pharmaceutical support – to reduce pain and inflammation, stabilize cell membranes, promote healing, and so on.

Preventing DCS is preferred to treating DCS. Treatment with pressure, O<sub>2</sub>, and time are effective when a symptom occurs. Adjunctive pharmaceutical and emergency care interventions are also needed in extreme cases. One consistent observation about subjects at the NASA Johnson Space Center (JSC) is that pain-only DCS after significant denitrogenation, or prebreathe (PB), occurs predominately in the lower body, particularly in the part of the body associated with or around the patella of the knee (Ryles & Pilmanis 1996, Degner *et al.* 1965). Subjects often reported fullness, awareness, or a frank pain when the leg was horizontally flexed with the body in a supine position. This pain, fullness, or awareness would abate while the subject was standing or walking, only to return when the leg was once again horizontally flexed. Weight-induced compression temporarily counterbalanced or surpassed the offending deformation pressure, a condition that might present during EVA on a planetary surface but not during EVA in microgravity.

### **Hyperbaric DCS and Hypobaric DCS Are Different**

Diver DCS and aviator DCS have fundamental differences that suggest treatment strategies would be different. Piccard (1941) reminds us that the same 5-to-1 pressure reduction ratio for a saturation diver and an aviator does not result in the same evolved gas volume if there is not time in each case to reach equilibrium. He depressurized 2 equal volumes of water: 1 was equilibrated at 5 atmospheres absolute (ATA) before a depressurization to 1 ATA and the other was equilibrated at 1 ATA before a depressurization to 0.2 ATA. Piccard observed that the 5-to-1 ATA depressurization for the saturation diver cases caused many small bubbles to quickly form in the water, producing a “milky cloud.” A few large bubbles formed at a much slower rate in the 1-to-0.2 ATA depressurization for the aviator case. The total evolved volume was identical after both experiments came into equilibrium, but the time to reach the final evolved volume was shorter after the diver depressurization.

Now take this simple system into living tissue. Piccard knew that the evolved volume at 0.2 ATA for the aviator or 1.0 ATA for the diver, expressed as nitrogen (N<sub>2</sub>) volume or total gas volume, would be identical after both depressurizations. If the volume evolved is the critical variable, then both depressurizations would produce equally serious outcomes in a closed system. A closed system means that blood does not transport N<sub>2</sub> to or from the tissues. However, living tissue is not a closed system. In reality, the aviator breathes 100% O<sub>2</sub> at 0.2 ATA to prevent anoxia. The aviator has more time, due to slower gas evolution, for N<sub>2</sub> to exit the lungs at a faster rate than it exits the lungs of the diver, who is content to breathe air at 1.0 ATA.

The rate at which a distribution of stable micronuclei transforms into growing bubbles is greater in the diver than in the aviator. The diver produces many small bubbles whereas the aviator produces fewer larger bubbles. The initial size distribution of micronuclei in the tissues is also different for the diver and aviator and is based on the absolute pressure profile that each experienced (Yount 1979, Tikuisis & Gerth 2003). Piccard suggested that differences in the probability of bubble formation due to the critical radius ( $r_c$ ) concept, and the greater relative loss of N<sub>2</sub> from the tissues of the aviator than from the diver, account for the observed differences in outcome between the aviator and the diver.

The historical concept of  $r_c$  is that a bubble radius exists that would be in mechanical equilibrium with a given depressurization where it neither grows nor shrinks:  $r_c = 2\gamma / (P_2 - P_1)$ , where  $\gamma$  is



surface tension, and  $P_2$  and  $P_1$  are pressures such that  $P_2 - P_1 > 0$ . Tikuisis & Gerth 2003 summarizes contemporary thoughts about  $r_c$  and the reality of heterogeneous nucleation. Nuclei present in the tissue that have radii greater than  $r_c$  for a given depressurization would grow, and those that have smaller radii would remain stable. Surface tension, which is effective on very small bubbles, increases the bubble  $N_2$  partial pressure ( $P_{\text{bub}}N_2$ ) to reduce the  $P_{\text{tis}}N_2 - P_{\text{bub}}N_2$  difference, thus reducing diffusion of  $N_2$  into the bubble and slowing the initial bubble growth. Piccard's early experiment highlights the limits of the basic critical volume release hypothesis (Hennessy & Hempleman 1977) by introducing the complexities of bubble nucleation rate and bubble growth rate, and the reality of evolved gas in an open system.

The composition of gases in the bubble of a diver is different from the gas composition of an aviator's bubble (Van Liew & Burkard 1995). Because of physiological controls, the constancy of metabolic gas tensions of carbon dioxide ( $CO_2$ ),  $O_2$ , and water ( $H_2O$ ) vapor, about 132 mmHg for venous blood, dictates that the fraction of  $N_2$  in a bubble is much lower in the aviator than in the diver. Thus, a 5-to-1 pressure reduction has more consequences for the diver than for the aviator. During repressurization, the aviator has less of a burden of  $N_2$  to transform back into the dissolved state than the diver. Said another way, less repressurization is expected to resolve a symptom in the aviator than in the diver. A simple application of Boyle's law makes it clear that the aviator enjoys the same unit volume change on return to 1.0 ATA as the saturation diver on return to 5.0 ATA, but the pressure at symptom resolution minus the altitude test pressure ( $\Delta P$ ) for the aviator is only 0.8 ATA (1.0 - 0.2), compared to 4.0 ATA (5.0 - 1.0) for the diver. But for reasons described above, the gas composition of the offending unit volume of evolved gas is different, thus slowing the dissolution of the diver gas phase (see bubble model example in Fig. 24).

Providing DCS treatment options and adjunctive therapy for exploration-class missions must follow an evidence-based approach. The approach needs to ultimately match the most effective treatment to the anticipated risks, since providing proper medical treatment at remote locations not only is costly but also has an impact on the success of the mission (John-Baptiste *et al.* 2006, Rudge 1992, Krause & Pilmanis 2000, Dowell 1993, Dart & Butler 1998, and Butler *et al.* 2002).

## **NASA Classification of DCS**

Several classification schemes for signs and symptoms of DCS have been documented (Elliott & Moon 1993). At JSC, DCS symptom(s) are classified into Type I and Type II DCS, and it is necessary to define these categories since this terminology is used in various documents. Currently, the definitions for all evolved gas disorders reside in the Decompression Sickness Manual JPD 1800.3C. The effectiveness of treatment based on symptom classification has been challenged (Francis & Smith 1991), resulting in a new consensus to treat the sign or symptom and not the category. This symptom-based approach enables the medical officer (MO) to provide treatment options that are most effective instead of a one-size-fits-all approach.

### ***Type I DCS***

Symptoms of mild DCS (DCS Type I) are joint pain, involvement of the peripheral nervous system, or simple skin bends.

In Bends Test 1, Waligora *et al.* (1984) developed the following 4-point scale, which was used primarily to categorize the intensity and performance impact of pain-only Type I DCS:

- DCS Grade 1 – occasional, intermittent joint pain
- DCS Grade 2 – steady but tolerable joint pain
- DCS Grade 3 – severe and steady joint pain; not incapacitating
- DCS Grade 4 – severe joint pain with incapacitation of subject

After Bends 1 ended, Waligora *et al.* (1984) developed a 7-point symptom scale for Bends Tests 2–11. A pain scale above 3 was prevented by the test termination criteria in place for all testing at JSC. The complete scale can be found in Waligora *et al.* (1984). The first 3 grades were defined as follows:

- DCS Grade 1 – Joint awareness: Reports of awareness or fullness of joints. Subject does not experience discomfort and may not be certain that the sensation felt is other than the normal feeling arising from fatigue.
- DCS Grade 2 – Threshold of pain: Reports of discomfort, ache, or intermittent pain. The sensation does not interfere with activity. The subject may liken this feeling to a transient pain or stiffness that occurs during warm-up exercises.
- DCS Grade 3 – Pain: Reports of continuous pain rather than of ache or discomfort. Subject indicates that pain is just starting to interfere with activity. Some favoring of affected limb is reported or noticed by observers.

In Bends Test 11, the exposure was terminated at the diagnosis of DCS by the attending MO regardless of the degree of performance limitation or intensity of the Type I symptom(s). For Bends 11 and all subsequent NASA-sponsored tests, the exposure was terminated at the diagnosis of DCS, or for any persistent symptom even if DCS could not be diagnosed. The DCS case descriptions from JSC (see Appendix IV) include the grade of the Type I symptom.

### ***Type II DCS***

Symptoms of DCS Type II involve the central nervous system (CNS), the cardiovascular system (circulatory collapse/shock), and the pulmonary system (the chokes). A more complete discussion of symptoms that have been classified as Type II is in Conkin (2001). Symptoms related to unusual presentation of headache and inappropriate fatigue are also included under Type II DCS.

Type II DCS symptoms are considered serious DCS. This category includes but is not limited to the following: substernal disturbances (pulmonary chokes); involvement of the sensory, motor, and cognitive pathways of the brain and spinal cord; sudden collapse (neurocirculatory collapse); and even unexplained weakness. Pulmonary chokes make up a substantial percentage of this category. Signs and symptoms of serious DCS not specifically attributed to arterial gas emboli (AGE) would also appear in this category. Disturbances of the skin, such as rashes, mottling, paresthesia, and edema, which appeared as the only sign or symptom were not considered serious DCS in this analysis because there is no agreement on a classification of skin disturbances into either Type I or Type II DCS. Disturbances involving the skin were often placed into a separate

category. Also, the 20 or so cases of death (Dixon 1992, Fryer 1969) in research and operational aviation settings since 1940 certainly qualify as more than serious DCS, and therefore are not included in this category. Table I contains a sample of signs and symptoms that were classified as serious DCS from 73 reports. Adler (1964) provides an excellent description of serious DCS collected from the literature; also see Balldin *et al.* (2004).

**Table I. Signs and Symptoms of Serious DCS**

substernal disturbances	auditory disturbances
unproductive cough (chokes)	tinnitus
dyspnea	loss of hearing
neurocirculatory collapse	loss of balance
disruption of motor, sensory, and cognitive pathways in brain and spinal cord	generalized malaise (unexplained fatigue)
paralysis	diplopia
ataxia	nystagmus
dysmetria	distortion or blurring of vision
dysphagia	hemianopsia
vertigo	photophobia
dizziness	hyper- or hypoesthesia
numbness	hyper- or hypoalgesia
aphasia	hallucinations
amnesia	confusion
altered mood	depression
manic behavior	belligerence
disorientation	scotoma
severe headache (migraine-like)	nausea
bladder disturbances	loss of coordination
paresis in arms or legs	vomiting
cardiovascular disturbances	visual field disturbances
syncope	hypovolemic shock
hypotension	hyperkinesias
dyskinesia	pallor
cold sweat	

## ***Cutis Marmorata***

Cutis marmorata (CM) is a sign of DCS that appears on the skin as a mottled pattern.

Placing a sign or symptom of hypobaric DCS into Type I or Type II DCS is artificial and causes problems if a sign or symptom does not conveniently fit into one category or the other. The problem becomes acute when one is categorizing CM from a hypobaric exposure into Type I or Type II DCS. A categorization scheme lends itself to quick and effective treatment strategies only if it is specific. However, CM does not lend itself to a specific category. On the basis of the best medical advice available in 2002, CM was categorized as Type II DCS at JSC. As a result, case 149-01 in Appendix IV was classified as Type II DCS solely on the basis of the presence of CM. As the current definitions of DCS at JSC assign CM to a category by itself, CM is no longer deemed Type I or Type II DCS.

CM was thought to be initiated by a disturbance within the CNS, or a whole-body systemic response linked to a large volume of evolved gas. Therefore, a proper clinical response was initially to treat it according to the United States Navy (USN) Treatment Table (TT) V even when no other symptoms were present. This aggressive treatment of CM resulted from an incomplete understanding of its pathophysiology and the observation that CM is often associated with serious Type II symptoms. In essence, hyperbaric treatment was provided to mitigate a serious symptom not yet expressed. More information about CM is found in Conkin *et al.* (2002).

## ***Arterial Gas Embolism***

AGE is an evolved gas that produces the signs and the symptoms consistent with passage of that gas to the arterial circulation; that is, severe neurological manifestations.

We do not have a description of a diagnosed case of AGE. However, AGE cannot be definitively discounted as being 1 of 6 descriptions of Type II DCS described in this report because the rapid return to site pressure resolved symptoms that could have otherwise been used to diagnose AGE. Although information about patent foramen ovale (PFO) was collected from prospective and retrospective cases to better understand the risk of AGE, the results were inconclusive (Conkin *et al.* 2003).

## **Air Diver Treatment Tables**

Several USN TTs are used to treat Type I DCS, Type II DCS, and AGE using air or air and periods of 100% O<sub>2</sub> breathing in military, science, and recreational divers. There are also TTs for mixed-gas diving and saturation diving, and many variations of TTs exist in other countries, again all for divers. However, there has been little incentive to systematically evaluate new treatment paradigms for aviators and astronauts ever since the USN produced the current standard-of-care air and O<sub>2</sub> TTs that are applied to divers and aviators (Davis 1979).

### ***USN Hyperbaric Oxygen TT V and Extended TT VI***

Although symptoms of DCS were first identified in caisson workers, treatment protocols were not established until symptoms were routinely seen in divers. The most widely used tables are USN TT V and VI. These protocols include the use of 100% O<sub>2</sub>, so they are points of departure for aviator and astronaut treatment modifications. USN TT V is used for pain-only symptoms if symptoms resolve within 10 min at the maximum table depth of 60 feet of sea water (fsw), or 2.8 ATA. Using this protocol, ascending from maximum depth takes a total time of 135 min. Time is spent breathing 100% O<sub>2</sub>, alternating with 5-min periods of air breathing 3 times during the treatment to limit O<sub>2</sub> toxicity (Stepanek 2002). USN TT VI is used for treatment of Type II DCS symptoms, such as symptoms involving the CNS or cardiopulmonary systems; recurrence of previously treated DCS; or treatment of a patient already being treated with Table V whose pain did not resolve within 10 min on 100% O<sub>2</sub> at 60 fsw. The maximum depth in Table VI is also 60 fsw. However, the total treatment time is extended to 285 min and thus the patient spends a longer duration at each ascending depth (Stepanek 2002).

Diving is an integral part of astronaut training, conducted at NASA's Neutral Buoyancy Laboratory in Houston, Texas. In support of astronaut training, this facility also has hypobaric and hyperbaric chamber capabilities. The protocol currently used to treat a support diver or astronaut who has DCS is USN TT V or VI, depending on the severity of the symptom. The patient breathes 100% O<sub>2</sub> by mask, termed ground-level oxygen (GLO), while technicians prepare for hyperbaric oxygen (HBO) treatment. Regardless of whether DCS was induced by hyperbaric or hypobaric conditions, the patient is treated with HBO since a chamber is readily available.

### ***USAF Hyperbaric Oxygen TT V and Extended TT VI***

Hyperbaric DCS experienced by divers and hypobaric DCS experienced by aviators have several differences from each other, as described earlier. The current procedure for treating aviators with DCS is based on the United States Air Force (USAF) guidelines that are modifications of the USN TT V and VI. USAF TT V and VI incorporate modifications to the breathing schedule with additional air breathing to further decrease the risk of O<sub>2</sub> toxicity (Dart & Butler 1998). Any HBO therapy requires costly resources, and thus is a large limiting factor for aviators on missions distant from HBO chambers. It is therefore important to identify additional ways for treating hypobaric DCS in select populations that require fewer resources and are cost-effective. Dart & Butler (1998) suggested a more flexible treatment protocol for hypobaric-induced DCS in low-resource environments, with the aggressive use of GLO and lower pressurization. An aviator at altitude who descends to site pressure returns to a pressure at which all initial N<sub>2</sub> was dissolved in their tissues. So descent to ground alone satisfies the pressure component of the DCS treatment model. Additional treatment by breathing GLO incorporates all 3 DCS treatment components.

### ***Ground-level Oxygen***

GLO is an alternative to diver air or HBO TTs to treat aviators or astronauts. Standard diver HBO TTs intersperse periods of breathing air with periods of breathing 100% O<sub>2</sub> to maximize bubble dissolution, or are based only on air. So all current hyperbaric treatment option must

balance the reabsorption of a bubble through Boyle's law and the O<sub>2</sub> window (defined later) with the potential addition of N<sub>2</sub> to the tissues, since breathing HBO alone eventually causes pulmonary and CNS symptoms due to O<sub>2</sub> toxicity. Air breaks during diver or aviator DCS treatment add new N<sub>2</sub> to tissues, potentially working against otherwise effective treatment (Nikolaev 2013).

Modest treatment pressures with 100% O<sub>2</sub> to minimize O<sub>2</sub> toxicity and to eliminate N<sub>2</sub> uptake into tissues are options if symptoms are mild and if treatment starts early. *The effectiveness of limited treatment resources to successfully treat hypobaric DCS during EVA at a remote location is contingent on early recognition and prompt treatment of a symptom.* GLO is part of the USAF DCS treatment philosophy, particularly for Type I DCS. Limited validation is documented for the use of only GLO for Type I DCS patients who immediately descend upon symptom recognition (Krause & Pilmanis 2000, Muehlerberger *et al.* 2004, Rudge 1992). Krause & Pilmanis (2000) provide a comprehensive review and data about GLO. As expected, a large percentage of 728 exposures (97.2%) with Type I symptoms treated shortly after diagnosis had symptom resolution during descent while on 100% O<sub>2</sub>. They remained on GLO for 2 h and only 10 subjects (1.4%) had recurrent or delayed onset of symptoms. Those 21 subjects with symptoms at site pressure (2.8%) had symptom resolution during 2 h of GLO and no recurrent or delayed onset of symptoms. Unfortunately, there were no data permitting comparison of outcomes of subjects who had symptoms at site pressure and were allowed to breathe air with those who used GLO. On balance, GLO is an alternative for effective treatment of Type I DCS in remote locations where specialized equipment and medical training are not available.

### **Evolving Treatment Option: USAF TT VIII**

An attempt to lower the pressurization protocol is seen with USAF TT VIII, which was developed experimentally for hypobaric Type I DCS with onset of symptoms within 2 h of descent (Dart & Butler 1998, Butler *et al.* 2002). Treatment Table VIII uses a *lower* maximum pressurization of 33 fsw (2.0 ATA). In a remote location, this is advantageous in that O<sub>2</sub> toxicity and fire risk will be reduced, and fewer resources are needed. Although TT VIII is rarely used, this was a first attempt to validate a new DCS treatment protocol that addressed the needs of working with limited resources, akin to treatment protocols needed when working in space.

### **Current Astronaut Treatment**

A successful resolution of DCS symptoms in astronauts is conditional on early recognition and prompt treatment. Early recognition is through education and training, such as the use of the current EVA Cuff Classification system (see Appendix I for details). The DCS Treatment Flow (see Appendix II) ensures prompt treatment and minimizes the time required for return-to-duty. An EVA Cuff Classification system is used to classify symptoms during EVA and define actions necessary to minimize symptoms attributed to DCS. In brief, classes are categorized from 1 (mild pain) to 4 (serious symptoms). Classes 2-4 require termination of EVA and return to airlock for repressurization. With a suit pressure of 4.3 pounds per square inch absolute (psia) plus cabin pressure of 14.7 psia, the astronaut can pressurize to 19 psia just by returning to the International Space Station (ISS). A simple DCS medical examination is used at periodic intervals by the Crew Medical Officer (CMO) throughout DCS treatment. The exam involves both in-suit and out-of-suit questions assessing neurologic function and vital signs. If signs or

symptoms of DCS persist upon return to ISS, then the ISS DCS Treatment Flow algorithms are used to treat the astronaut with additional pressure, O<sub>2</sub>, and time. Details of this DCS treatment “system” for ISS EVAs are contained in MED EVAL DCS 31001 (rev. 6), 2012.

A significant difference between astronauts and aviators is in the availability of treatment resources. The majority of aviators who develop DCS at altitude must descent to site pressure and have access to HBO therapy provided by a trained medical staff. However, an astronaut must work with the materials available on the ISS, with a CMO and telemedicine support to experts. Currently it is not feasible or cost effective to transport a standard-of-care, dual-lock hyperbaric chamber to treat DCS in space. Various feasibility studies and evaluations of a hyperbaric airlock were documented, but plans to build, transport to the ISS, and maintain the treatment facility were abandoned due to budget constraints and other operational challenges (Norfleet 1992, Barratt 1996, John-Baptiste *et al.* 2006). One hundred percent O<sub>2</sub> and a lower pressurization to treat DCS are available for current space exploration. These resources currently balance the low risk of DCS during EVA with effective treatment, minimal cost, and limited resources.

### ***Bends Treatment Apparatus***

In the rare instance that DCS symptoms are serious, do not resolve with 100% O<sub>2</sub> at 19 psia (4.3 psia suit + 14.7 psia cabin pressure) regardless of symptom classification, or first appear after the EVA, then the Bends Treatment Apparatus (BTA) is used (Snow 2001). The BTA is a small mechanical device that allows pressurization of the spacesuit to 8.0 pounds per square inch delta (psid). It has small mass and volume that are ideal for storage. A suit pressure of 8.0 psid plus the 14.7 psia ISS cabin pressure allows a total pressurization of 22.7 psia (1.54 ATA). The suit is unavailable for EVA after this application as a treatment vessel, until it is recertified.

### **Adjunctive Pharmaceutical and Emergency Care Interventions**

As adjunctive therapy, the medical kit aboard the ISS has 4 liters of normal saline. A crewmember would first attempt to drink fluids orally, but intravenous normal saline at 1 liter per h can be administered. In addition, limited quantities of dexamethasone and lidocaine are available. The ISS is equipped with a respirator and automated external defibrillator for the most severe cases. Under extreme conditions, a return to Earth is possible, if the astronaut is deemed fit enough for the rigors of reentry.

Aspirin is currently used for prophylaxis. Crewmembers are instructed to take 1 tablet  $\geq$  180 mg the night before an EVA and then another before donning the spacesuit. Aspirin inhibits platelet aggregation that might occur on the surface of bubbles, leading to activation of the coagulation cascade. The medical kit for future exploration-class missions where return to Earth is not possible may contain the following items to support DCS treatment:

1. Isotonic fluid helps when a patient experiences loss of volume from transduction of plasma across damaged capillary walls (Stepanek & Webb 2008). Replacing fluids will increase central blood volume, increase preload to the heart, and accelerate inert gas washout (Moon & Gorman 2003). Currently 4 liters of normal saline are on the ISS.

2. Steroids may be useful for CNS edema but the evidence shows mixed results and additional research is required (Stepanek & Webb 2008).
3. The use of heparin to prevent deep vein thrombosis is recommended in cases of neurologic DCS affecting the spinal cord that results in immobility (Stepanek & Webb 2008).
4. Lidocaine has shown favorable results in the treatment of DCS as a neuroprotective agent, and investigation continues (Stepanek & Webb 2008).
5. Intravenous perfluorocarbon emulsion, which is an efficient O<sub>2</sub> and N<sub>2</sub> carrier, combined with 100% O<sub>2</sub> shows promising results to improve tissue oxygenation and N<sub>2</sub> excretion (Stepanek & Webb 2008), but O<sub>2</sub> toxicity is a concern (Moon & Gorman 2003).

## **NASA DCS Data**

Data for the Hypobaric DCS Treatment Model, hereafter called “treatment model”, and for the DCS and venous gas emboli (VGE) survival models described in this report come from the NASA Hypobaric Decompression Sickness Database. These data were assembled from 30 years of hypobaric chamber research from 5 laboratories on effective denitrogenation (prebreathe, PB) techniques from 47 protocols totaling 969 human exposures (786 male and 183 female). Subjects were volunteers who were informed of all risks to participate and could withdraw at any time without penalty. All protocols were approved in advance by an institutional review board at each test location. Subjects were prescreened for health issues and eliminated if unable to pass a NASA-modified Class III Air Force flight physical, or equivalent. Subjects received instructions about DCS and other risks associated with hypobaric exposure, were trained on equipment and procedures, and understood their responsibility to report symptoms during and after the hypobaric exposure. Test termination criteria were posted in the test area. Mean age  $\pm$  standard deviation (SD) for 969 exposures was  $31.9 \pm 7.7$  years.

Tests were performed in altitude chambers, often at 4.3 psia. Subjects either underwent a no-prebreathe protocol or breathed 100% O<sub>2</sub> by mask for some time before ascent. At altitude, all subjects breathed 100% O<sub>2</sub> or O<sub>2</sub>-enriched air. Exposure durations ranged from 3 to 24 h at ambient pressures of 4.3, 6.0, 6.5, 10.1, and 10.2 psia. Prescribed moderate and repetitive intervals of physical activity with or without ambulation was also performed from 3 to 6 h, depending on exposure duration. In tests without ambulation, subjects were seated or semi-recumbent and physical activity consisted of primarily upper-body exercise. In general, subjects were removed from the altitude chamber through an airlock after a report of a DCS symptom, thus permitting the test to continue with the remaining subjects. An exception is that ambulatory subjects in some early protocols were allowed to continue until a symptom(s) interfered with performance of the prescribed exercise.

Between 1 and 4 subjects participated in each test; multiple tests were run on each of 47 PB protocols to characterize the DCS and VGE outcomes of the protocols. The number of subjects participating in each protocol ranged from 3 to 56. Noninvasive precordial monitoring for VGE in the pulmonary artery blood flow (venous blood) was performed for 4 min at about 15-min intervals using various Doppler ultrasound bubble detectors (2.5 – 5.0 megahertz [mHz]) through the years. A VGE grade between 0 and IV was assigned to each limb region after the subject sequentially and rhythmically flexed the limb about 3 times. Other details about VGE



monitoring are described elsewhere (Waligora *et al.* 1984, Conkin *et al.* 1996a). Details of the DCS symptoms and VGE detected are provided as Appendix IV. Details of the PB protocols are provided as Appendix V, and a summary of all protocols is provided as Appendix VI.

The pressure at which the symptom resolved during the exposure, during repressurization to site pressure, or at site pressure was recorded. There was no requirement during initial protocol testing to provide post-test GLO breathing. However, 1 and then 2 h of GLO were eventually adopted to reduce the chance of post-test symptoms for those with symptoms that resolved during repressurization and for those with no symptoms but with VGE still present at the end of the hypobaric exposure. Subjects with persistent or residual symptoms at site pressure, unusual symptoms during the test, or new or recurrent symptoms after being released from the study were treated by the MO as a minimum with 2.8 ATA HBO USN TT V. Currently a subject with a mild Type I symptom that resolves during immediate repressurization is provided a prophylactic USN TT V as an intervention to reduce the chance of recurrent or new symptoms.

There were 220 symptoms from 119 cases of DCS in 969 exposures. The pressure at which these symptoms resolved was recorded for 195 symptoms, either at the test altitude, during the repressurization to site pressure, at site pressure, or during a 2.8-ATA HBO treatment. These 220 symptoms were entered into the NASA Hypobaric Decompression Sickness Treatment Database for analysis related to the treatment model. Details about the symptom data are provided in Appendix III. The difference between the pressure at which a symptom resolved ( $P_2$ , psia) and the pressure at which the symptom occurred ( $P_1$ , psia) is called the treatment pressure or  $\Delta P$ , in units of psid.

### **$\Delta P$ in Air Force DCS Data**

Fig. 1 from Muehlberger *et al.* (2004) is very important to our understanding of hypobaric DCS symptom resolution. The development of any probabilistic DCS treatment model must ultimately describe these data. The NASA data used in our analysis are, in essence, a smaller independent sample of the larger set of data used to create Fig. 1 (also see Fig. 41).

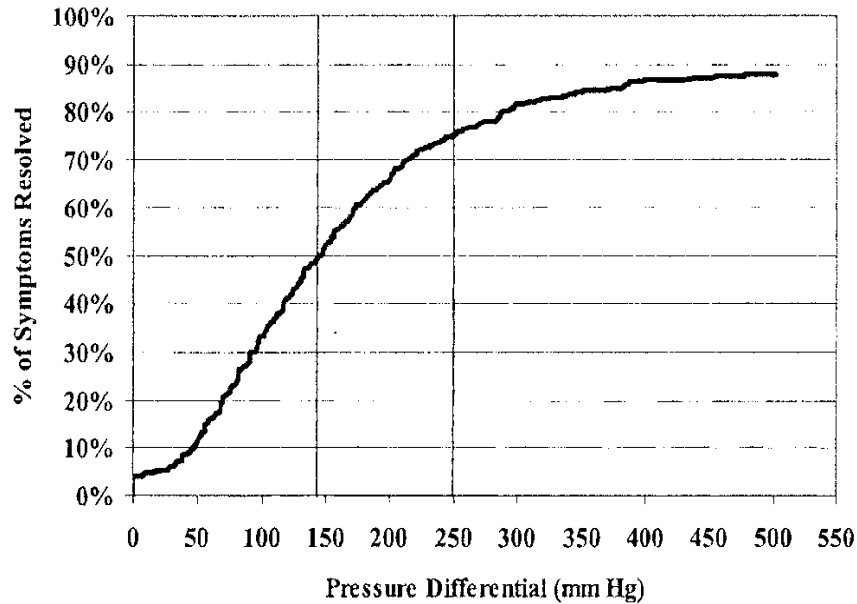

Fig. 1. Cumulative percent of symptoms (n = 1,499) that were resolved according to pressure increase in mmHg. Note: These 1,499 (88.2% of 1,699) symptoms resolved before total recompression to ground level.

Fig. 1 is based on 1,699 symptoms that resolved before, during, and after a repressurization to site pressure at Brooks Air Force Base (AFB). Sixty-six symptoms resolved at the test altitude and 1,516 resolved during repressurization; however, 83 symptoms had no documented treatment pressure. The curve shows the cumulative proportion of 1,499 symptoms that had documented treatment pressures and resolved before or during repressurization, out of 1,699 total symptoms that all eventually resolved at site pressure.

A better way to estimate the percentage of symptoms that resolved before or during repressurization would be to remove the 83 symptoms that had no treatment pressure from the denominator, giving 1,616 total symptoms with treatment pressures. Therefore, the last point on the figure would be 92.7% (1,499/1,616) instead of 88.2% (1,499/1,699). There were 117 symptoms that resolved at site pressure. Adding these 117 symptoms that resolved at site pressure to the 1,499 with treatment pressures accounts for 100% of 1,616 symptoms that resolved and had a treatment pressure. Most subjects continued with 2 h of GLO breathing even when a symptom resolved before, during, or after a repressurization to site pressure. This treatment intervention likely helped to resolve symptoms still present at site pressure and likely reduced the incidence and severity of recurrent symptoms.

Table II summarizes Muehlberger's data from 2,709 chamber exposures with 315 subjects that resulted in 1,699 individual symptoms that resolved at altitude, during repressurization, and at site pressure.

**Table II. Literature Data on Symptom Resolution**

<b>symptom category</b>	<b>symptom resolution details</b>	<b>treatment pressure data</b>	<b>% of total 1,669</b>
A	resolved at altitude	66	3.8
B	resolved on repressurization	1,433	84.3
C	resolved on repressurization but without documented treatment pressure	83	4.9
D	resolved at site pressure	117	6.9
	total symptoms resolved	1,699	100.0

Muehlberger reported that all 1,699 symptoms resolved at altitude, during repressurization, or at site pressure. Our experience is that some symptoms persist at site pressure. Muehlberger did not provide detailed information on the prevalence of persistent or recurrent symptoms that needed additional treatment pressure. He mentioned that, of 117 symptoms that resolved at site pressure, 112 were referred to HBO treatment (2.8 ATA) with no explanation. Of the 1,433 symptoms that resolved during repressurization to site pressure, 52 were referred to HBO treatment for various reasons, such as the symptom being serious (pulmonary) or recurring. For 93% of the 1,433 symptoms that resolved before reaching site pressure the subjects continued with 2 h of GLO treatment at site pressure. About 56% (89 of 158) of symptoms in the NASA dataset were subsequently treated with a period of GLO, most often 1-h. Additional details not available from Muehlberger are available from the Air Force Research Laboratory Altitude Decompression Sickness Research Database archived at Wright-Patterson AFB (<https://biodyn.istdayton.com/CBDN>). We summarize and analyze these 1,699 symptoms later in this report.

### **USAF Data Compared with NASA Data**

Fig. 2 shows results from a regression of 121 of 136 (88%) symptoms that resolved during repressurization to site pressure in our limited NASA data. The additional 17 symptoms that resolved at site pressure plus the 121 that resolved during repressurization are the denominator for computing the cumulative proportion of symptoms that resolved just during repressurization. Our 37 symptoms that resolved before repressurization are not considered here. After the 66 symptoms that resolved at altitude were removed, the data from Muehlberger were comparable to the NASA data; 92.8% (1,516/1,633) of symptoms resolved during repressurization.

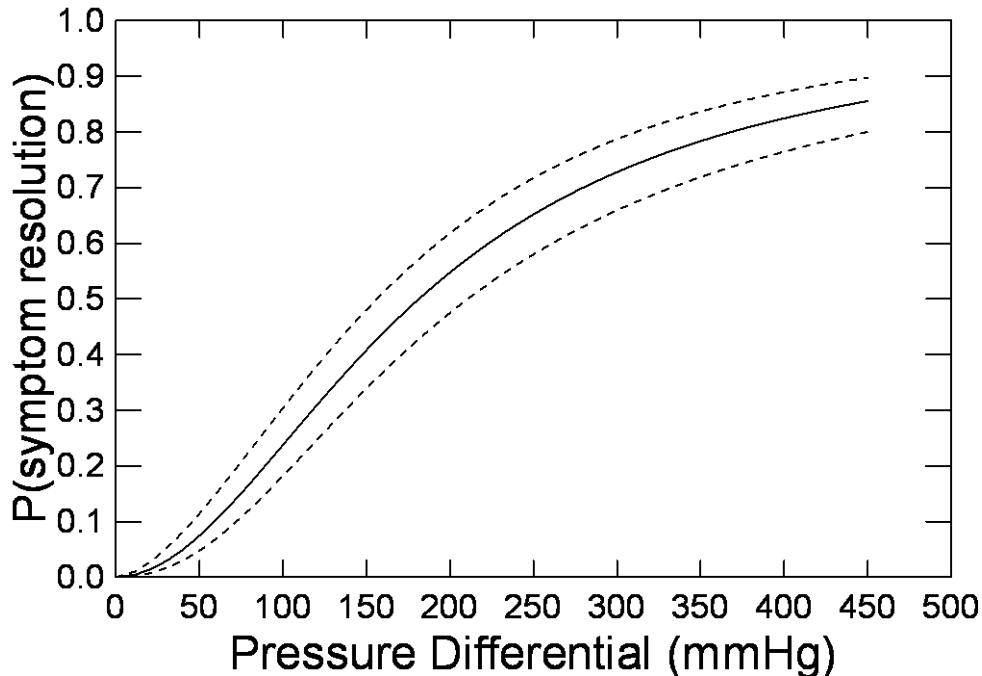
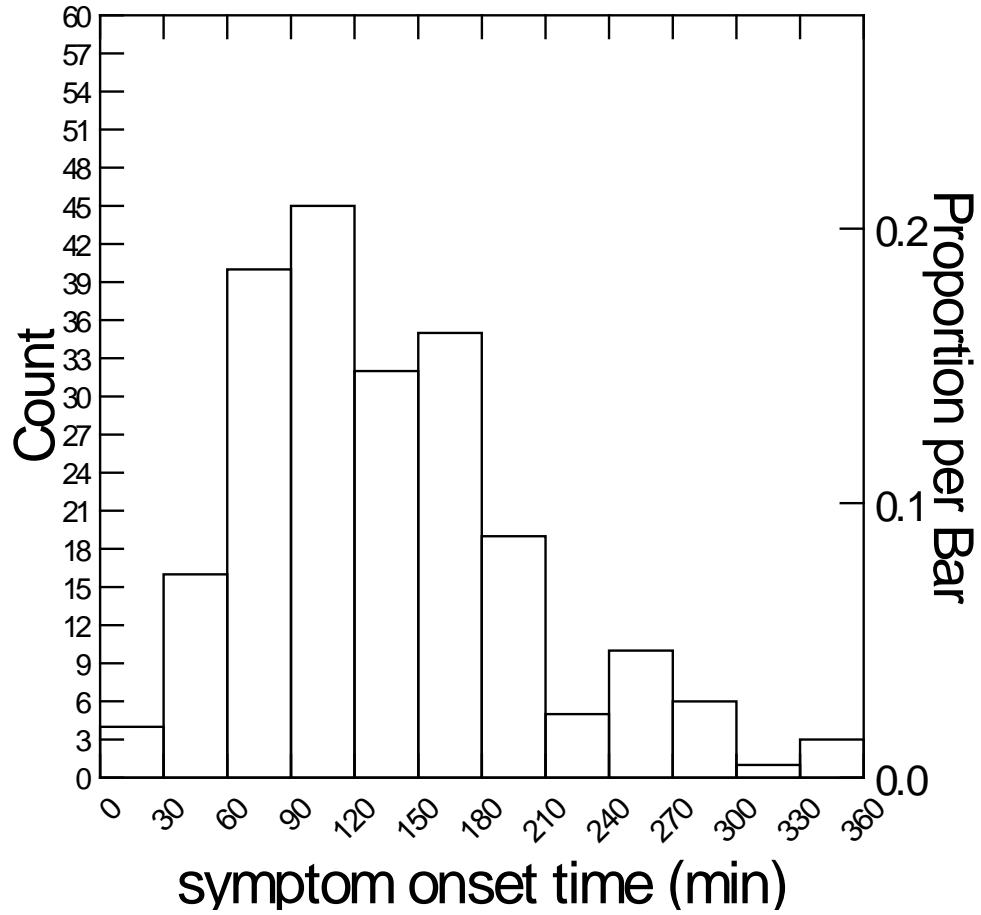

**Fig. 2. Regression results of symptom resolution during repressurization. Out of 138 symptoms, 121 resolved during repressurization to site pressure and 17 symptoms resolved at site pressure. Regression model:  $P(\text{symptom resolution}) = 1 / (1 + \exp(-(\ln(\Delta P) - 5.20) / 0.511))$ , plus 95% upper and lower confidence limits, where  $\Delta P$  is pressure differential in units of mmHg.**

It is clear that the limited NASA data (121 of 138 symptoms) on symptom resolution during repressurization resembles the 12-fold more data (1,516 of 1,633 symptoms) from the USAF, particularly when considering the 95% CL on Fig. 2. An immediate return to site pressure after the onset of a DCS symptom from a wide variety of hypobaric exposure conditions has about a 90% probability of resolution. Additional GLO is expected to resolve symptoms still present at site pressure and reduce recurrence of symptoms, and in a small number of cases HBO treatment would be warranted.

### **NASA Symptom Data**

The observation that 2 cumulative distributions of symptom resolution are similar from NASA and USAF sources given a wide variety of hypobaric exposures suggests that a common underlying mechanism is present in the evolution and resolution of DCS symptoms. Fig. 3 shows the distribution of onset time for 216 symptoms in the NASA data. The cumulative distribution of those data in Fig. 4 shows the expected S-shaped curve. Compare this to the S-shaped cumulative distribution of the  $\Delta P$  data in Fig. 5. It is clear that an underlying mechanism links the onset time of a symptom and the  $\Delta P$  needed to resolve the symptom, even if the mechanism is not yet understood. We show this linkage later as we develop the treatment model.



**Fig. 3.** Histogram distribution of symptom onset times in 216 of 220 symptoms in 119 cases of DCS. The distribution is skewed to the right, with the largest number of reports at about 120 min into the exposures.

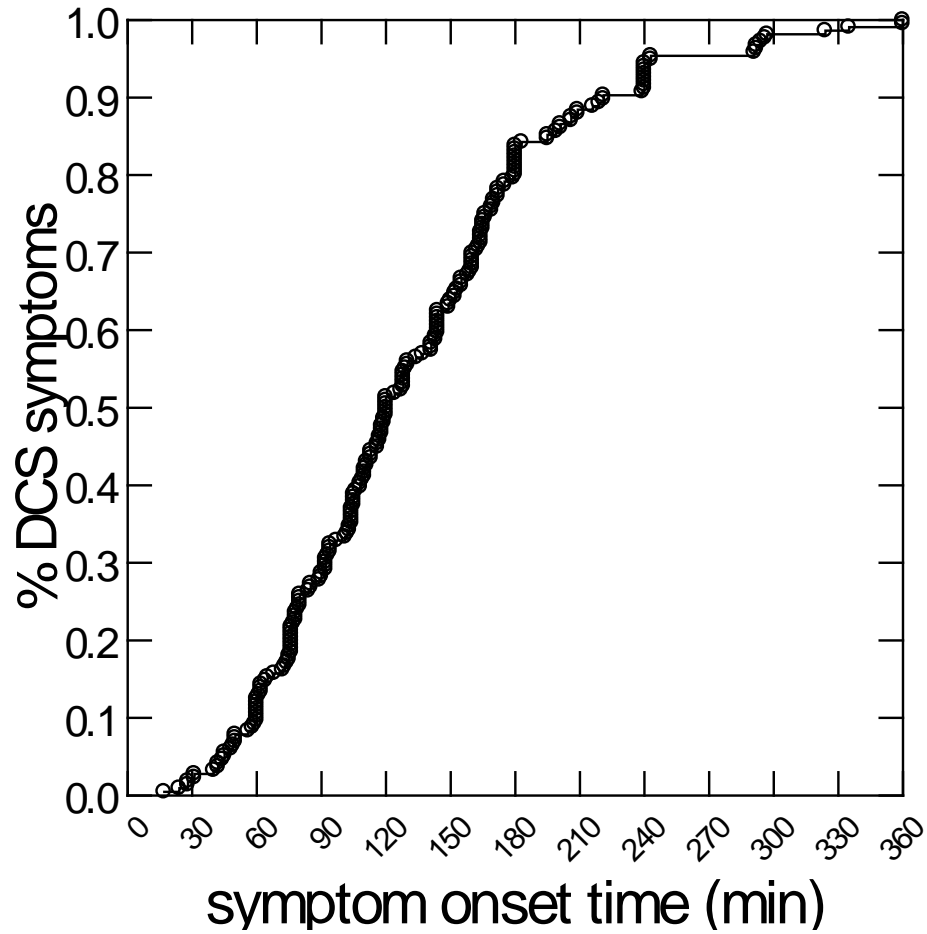

**Fig. 4. Empirical cumulative distribution  $[F_n(t)]$  of 216 symptom onset times in 119 cases of DCS. Four symptoms had no onset times. Onset (failure) time for the first symptom in each of the 119 cases of DCS was used in our survival analysis. Note the S-shape of the cumulative distribution.**

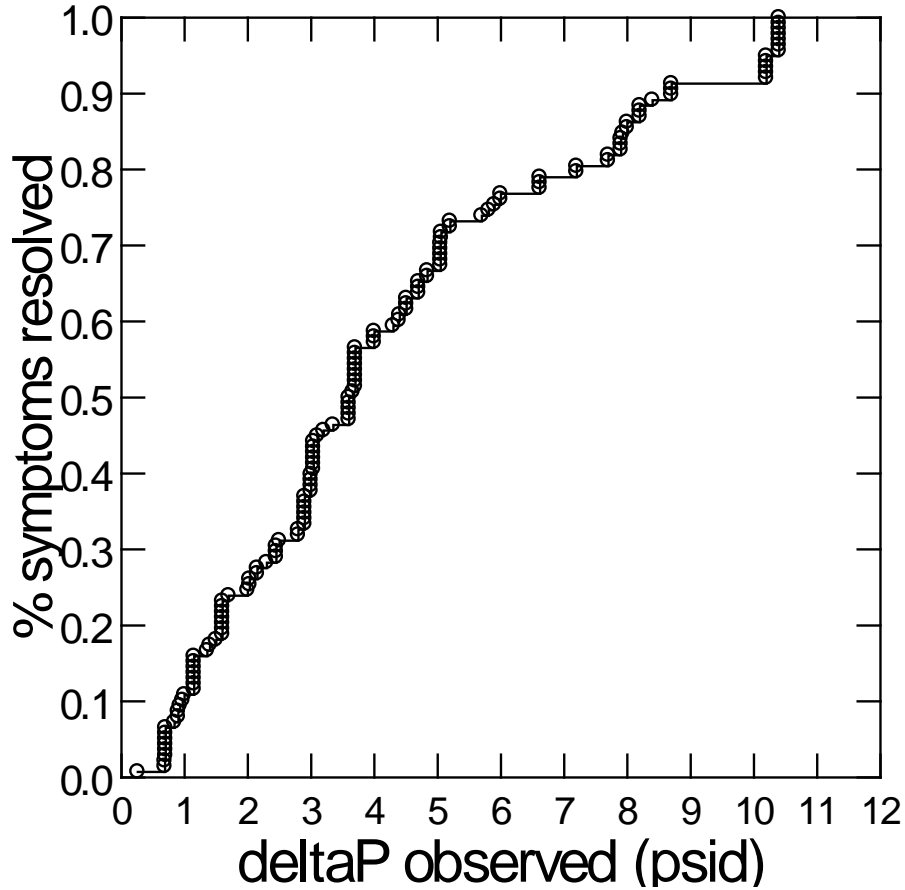

**Fig. 5. Cumulative proportion of 138 symptoms that resolved during repressurization and at site pressure. Not included are 37 symptoms that resolved at the test altitude, before repressurization. One hundred and twenty-one symptoms (88%) resolved during repressurization and 17 symptoms (12%) resolved at site pressure (between 14.5 and 14.7 psia). Twenty symptoms that persisted at site pressure and resolved during a 2.8 ATA HBO treatment are not included. Note that the S-shape is similar to the cumulative distribution of 216 symptom onset times in Fig. 4.**

It seems that regardless of the decompression stress, a few subjects will report a symptom, early or late, that then resolves with a modest increase in pressure, regardless of the pressure at which the symptom appears. This phenomenon is seen as the upward inflection of the cumulative distributions to the right of the origin on Figs. 4 and 5. A few subjects are particularly sensitive to the deformation pressure (see below) caused by evolved gas in a particular tissue and are equally responsive when deformation pressure is reduced with the application of pressure during repressurization.

The prevalence of symptoms from the knees and ankles is fortuitous as it narrows discussion to a particular anatomy and to a simple mechanical mechanism of symptom onset and resolution (Hills 1979). In addition to S-shaped cumulative distributions for onset times and  $\Delta P$ s for symptom resolution, it seems that there would also be an S-shaped cumulative distribution of deformation pressures caused by evolved gas, which dictates onset times and  $\Delta P$ s for symptom resolution.

## Individual Perception of Pain

The perception of pain is subject-specific in that each person has a threshold for perception of a noxious stimulus (Conkin *et al.* 1998), modified by many factors. Eq. 2 shows that the subjective intensity (I) of a sensation is equal to the difference between the intensity of the stimulus (S) and a threshold stimulus ( $S_o$ ) to a power ( $\xi$ ):

$$I = k_1 \times (S - S_o)^\xi, \quad \text{Eq. 2}$$

where  $k_1$  relates the magnitude of the stimulus to the intensity of the sensation. The same incremental increase of the stimulus has a greater influence on the intensity of the sensation when  $\xi$  is  $> 1$ , and other relationships are possible when  $\xi$  is  $\leq 1$ . Stimulus is not time-dependent in Eq. 2 and yet the rate and duration of the stimulus certainly influences the perceived intensity. The sensation  $[(S - S_o)^\xi]$  in our case is pain localized in or near a joint, purportedly caused by mechanical stimulation of sensory receptors (Hills 1979). The stimulus is a constrained volume of gas that produces a pressure difference or deformation pressure ( $\delta$ ) between the bubble and surrounding tissue. Deformation pressure and evolved gas in living tissue are functionally linked even though the exact relationship must be complex (Srinivasan & Gerth 2013). Eq. 3 defines  $\delta$  as equal to evolved gas in a volume of tissue:

$$\delta = k_2 \times V_{\text{tot(a)}} / V_t, \quad \text{Eq. 3}$$

where  $V_{\text{tot(a)}} / V_t$  is the volume of all gas released, expressed here at ambient pressure, per unit volume of tissue, and  $k_2$  is the bulk modulus of the tissue. Values for bulk modulus between 2 and  $11 \times 10^4$  dyne / cm<sup>2</sup> have been published for connective tissues and a value as high as  $2.5 \times 10^8$  dyne / cm<sup>2</sup> is documented for articular cartilage. Deformation pressure as the stimulus for pain is directly related to the evolved volume of gas per unit volume of tissue in Eq. 3.

Many environmental and subject-specific factors dictate the actual  $V_{\text{tot(a)}} / V_t$ , some of which we attempt later to mathematically describe with the Tissue Bubble Dynamics Model (TBDM) (Gernhardt 1991). The location of the evolving or resolving gas phase influences  $\delta$  through the particular properties of the tissue bulk modulus. The perception of pain, its onset or resolution, is influenced by someone's sensitivity, as dictated by the density and type of nerve fibers in the tissue that dictate the threshold and magnitude of response, as suggested in Eq. 4, the combination of Eqs. 2 and 3.

$$I = k_1 \times (\delta - \delta_o)^\xi, \quad \text{Eq. 4}$$

This line of discussion may explain the similarities between cumulative distributions of symptom resolution with  $\Delta P$  in the NASA and USAF data irrespective of sample sizes. There seem to be distributions of individual sensitivities as well as deformation pressures caused by evolved gas in the knees and ankles. This mechanistic framework would explain the particular and repeatable pattern of cumulative distribution for symptom resolution given the wide variety of hypobaric



conditions evaluated. Subjects respond differently to deformation pressure – some are sensitive to a small increase while others respond only to a larger increase. A probabilistic and not a deterministic process seems evident, both in the perception of a symptom and the resolution of a symptom. Variability is manifested in a probabilistic outcome as evident in the cumulative distribution of symptom resolution during repressurization. So both the likelihood and resolution of DCS are inherently probabilistic.

### Symptom Intensity and P(DCS)

It is observed that the greater the P(DCS), the greater the symptom intensity. The nonlinear relationship between group incidence [P(DCS)] and mean symptom intensity is seen in Fig. 6. A conservative PB protocol results in a lower P(DCS) and is clearly associated with less symptom intensity. It follows that an intensely painful symptom may require a greater  $\Delta P$  to resolve (Fig. 8). Conversely, less symptom intensity is expected to resolve with a modest  $\Delta P$ .

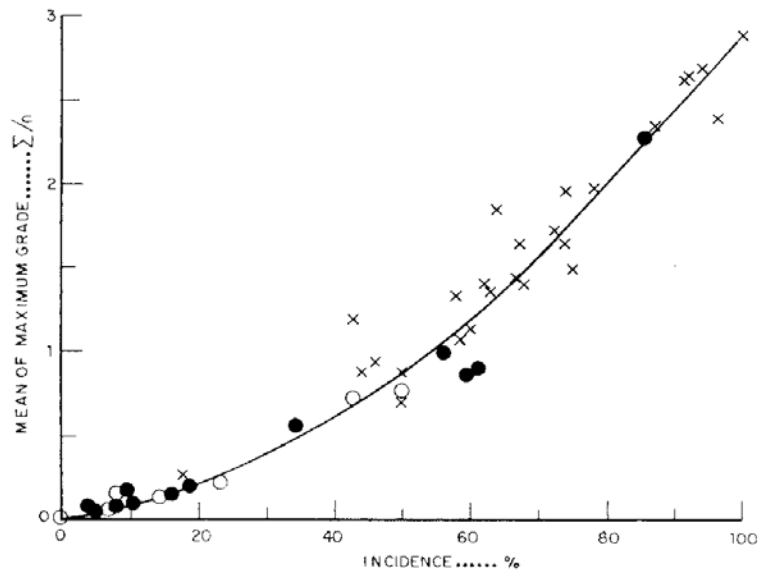
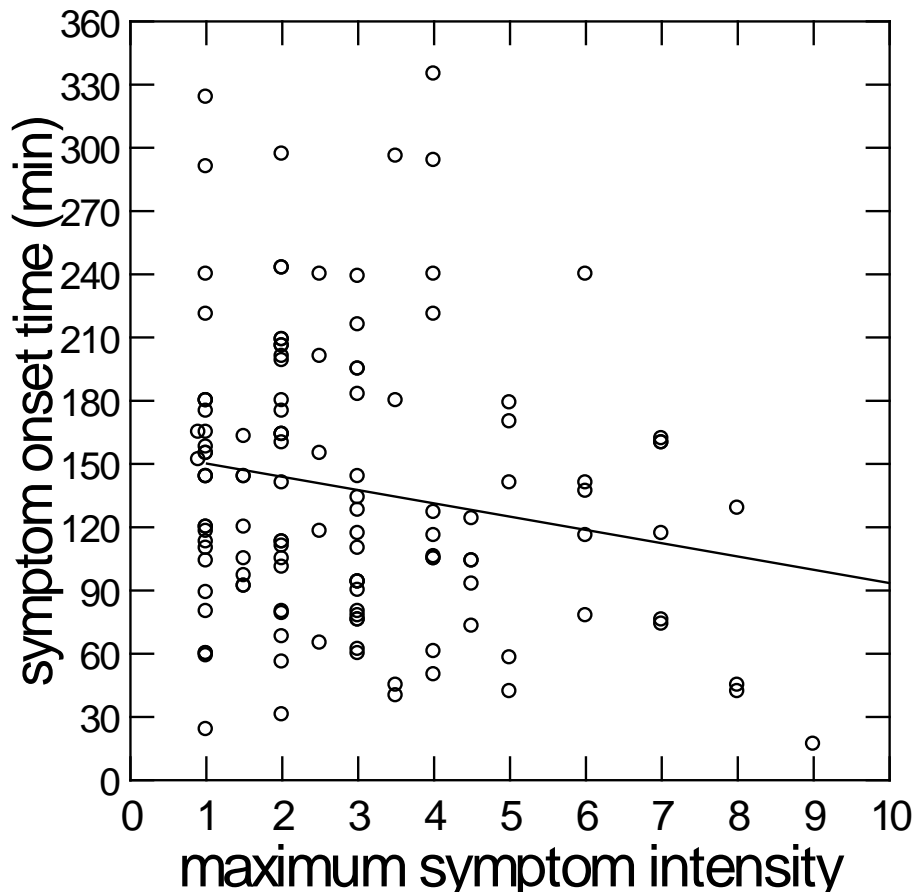

Fig. 4. Incidence and mean grade of altitude decompression sickness from 1942 to present: Crosses, 26 types of exposure with no information on body fat (Table II); Circles, 13 types of exposures (Table I), if filled F > 12 kg, if not filled F < 12 kg.

522 *Aerospace Medicine* • May, 1971

Fig. 6. Data from Allen *et al.* (1971). Grade 1 is mild, intermittent pain; Grade 2 is tolerable, continuous pain; and Grade 3 is intolerable pain that cleared on descent. If the P(DCS) is very low, then the intensity of pain is low and modest treatment intervention is expected to be effective.

Also, symptom intensity may be associated with symptom onset time, both of which could influence the P(symptom resolution). Fig. 7 shows the few NASA data pertaining to maximum symptom intensity and symptom onset time. Initial efforts to quantify a relationship between symptom intensity and onset time, P(DCS), and P(symptom resolution) for a given  $\Delta P$  are described in this report (see Overall Risk Model for Future Missions).



**Fig. 7. Association of maximum symptom intensity with symptom onset time, for 128 symptoms. Linear regression: symptom onset time =  $-6.4 \times (x) + 156$ , where  $x$  is maximum symptom intensity;  $r^2 = 0.033$ .**

Fig. 8 shows the relationship between maximum symptom intensity, available for 79 of 138 symptoms, and the  $\Delta P$  to used resolve the symptom. The relationship ( $r^2 = 0.032$ ) is not as strong as one might expect given the simple formulation of Eq. 4.

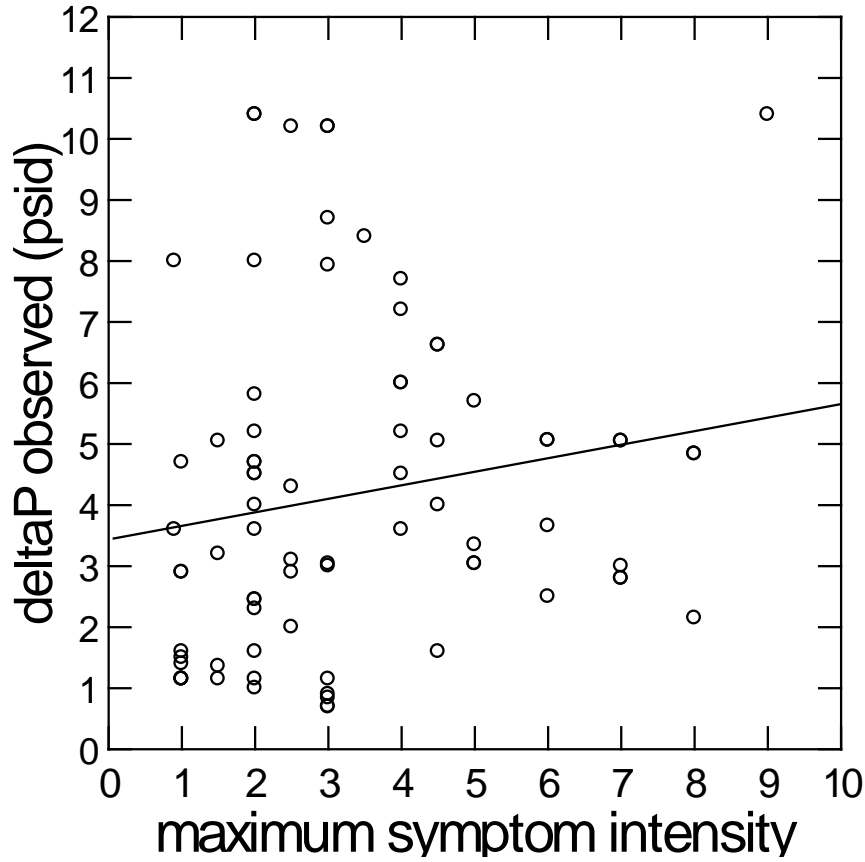

**Fig. 8. Maximum intensity score from 79 of 138 symptoms associated with the observed  $\Delta P$  during repressurization to site pressure. When a range of intensity was reported, the mean intensity was used. When intensity was reported as  $< 1$ , then 0.9 was used. Linear regression:  $\Delta P = 0.234 \times (x) + 3.44$ , where  $x$  is maximum symptom intensity;  $r^2 = 0.032$ .**

Finally, Fig. 9 shows that the number of symptoms generally increased as the group incidence of DCS increased in 40 NASA protocols from 1982 to 2009. The increase in symptom count was greater than it would have been with just the addition of one symptom for each new subject with DCS. More symptoms per subject were reported as group incidence increased. Several data points overlap; for example, 10 protocols had no DCS and no symptoms, and are all represented by a single point at the origin. Symbol size reflects the number of samples in the protocol, and the regression line is weighted to reflect the number of samples, for a total of 820 altitude exposures.

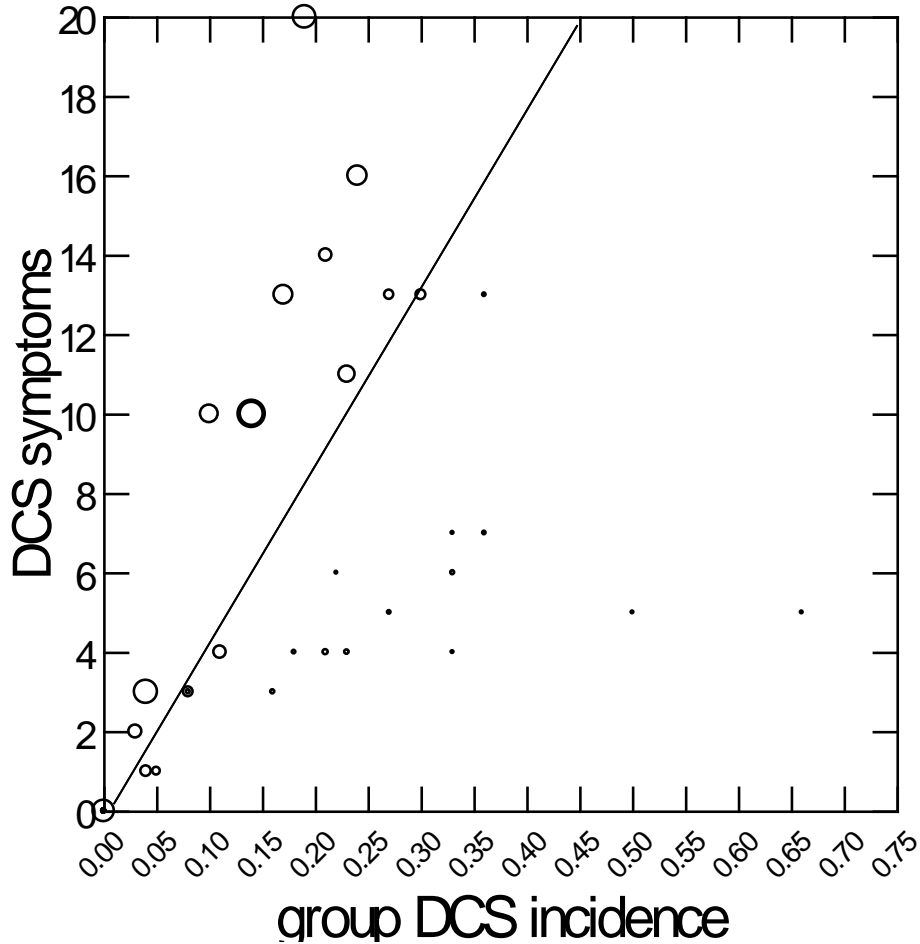

Fig. 9. Number of 220 symptoms associated with group DCS incidence from 40 protocols. Symbol (circle) size reflects the number of samples in the protocol.

### NASA Symptom Resolution Data

Table III shows 220 symptoms in 119 subjects with DCS parsed into 6 symptom categories, and 195 symptoms associated with a treatment pressure. The difference represents 25 symptoms that resolved but the treatment pressure was not recorded. About 17% of symptoms resolved at the test altitude, compared with about 4% for the USAF study of Muehlberger *et al.* (2004). Early testing at JSC allowed subjects to remain at 4.3 psia past the point of reporting a symptom, which was not the case in testing by the USAF. Breathing 100% O<sub>2</sub> at altitude is a treatment for a symptom, and given enough time with a mild symptom, 37 of 220 symptoms (17%) resolved before the start of repressurization. The majority of symptoms (70%) resolved during repressurization and shortly after reaching site pressure, near 14.7 psia at 4 testing sites. Twenty symptoms (9%) that were persistent at site pressure resolved after a course of HBO treatment at 41 psia (2.8 ATA), either USN TT V or VI. A clinical HBO treatment protocol was applied in totality regardless of whether the subject reported that the symptom resolved during any phase of treatment.

Table III. NASA Data on Symptom Resolution

symptom category	symptom resolution details	count	% of 220 symptoms	treatment pressure data	% of 195 symptoms with pressure data
A	resolved at altitude	37	16.8	37	19.0
B	resolved on repressurization	137	62.2	121	62.0
C	resolved at site pressure	17	7.7	17	8.7
D	resolved after HBO for a persistent symptom at site pressure	20	9.1	20	10.2
E	no treatment pressure information exits	9	4.1	0	0
	total	220	100.0	195	100
F	resolved but then reoccurred or was new and treated with HBO	13	+	+	+

+ Since repressurization resolved 13 cases, a treatment pressure already exists higher in the table even though an HBO treatment was later required.

Fig. 10 makes the point that gender and a wide range of age are present in the symptom data. Both gender and age are subsequently evaluated as explanatory variables in the treatment model. Similar distributions for age are evident between men and women even though women represented just 21% of the 119 cases of DCS.

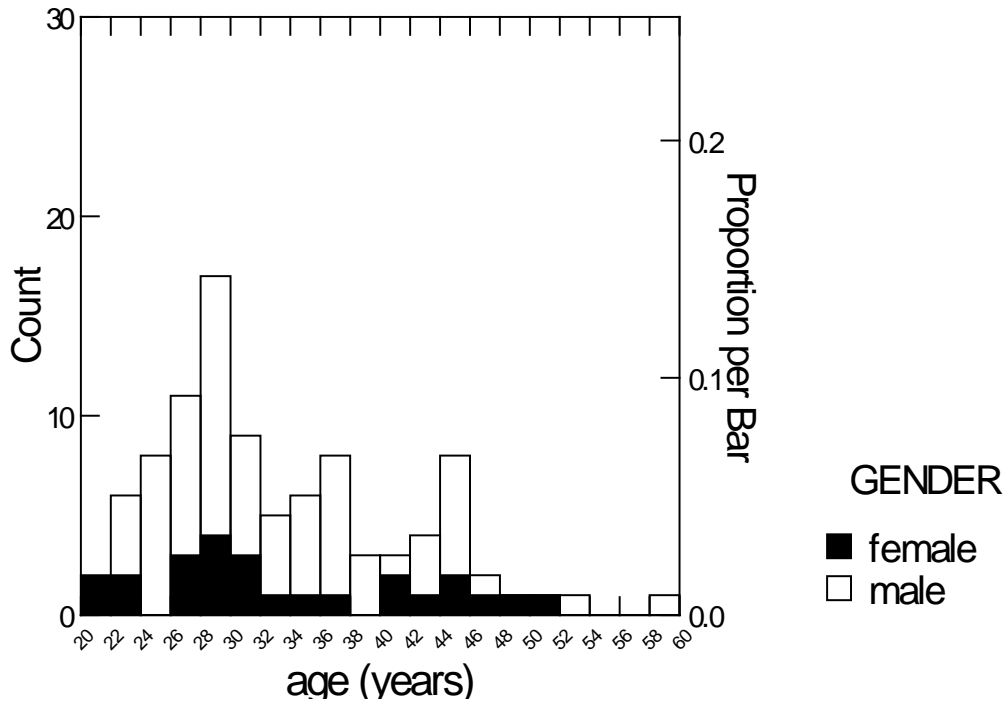

Fig. 10. Histogram distribution of age in 119 men and women with DCS.

## Symptoms

Figs. 11, 12, and 13 summarize the anatomical locations and attributes of 220 symptoms in our 119 cases of DCS. Fig. 11 shows that the lower body (knees and ankles) dominates the location of symptoms, but evolved gas was not restricted to the knees and ankles. A greater percentage of 220 total symptoms were in the knees and ankles of subjects who ambulated (70%) than in those who did not ambulate (50%),  $P = 0.004$  from Pearson  $\chi^2$ . Other variables besides ambulation status were not controlled and thus were assumed equivalent in this summary comparison. The symptom was often described as painful and constant in character (Fig. 12). Conservative PB protocols and test termination criteria limited our experience with Type II DCS (Fig. 13).

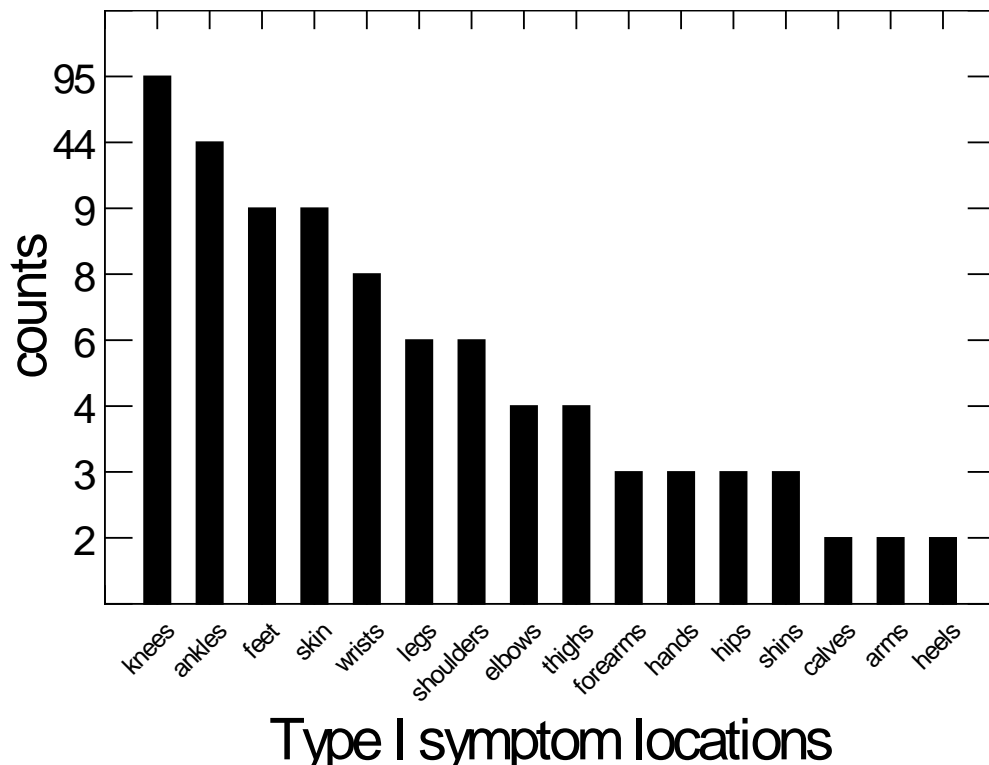
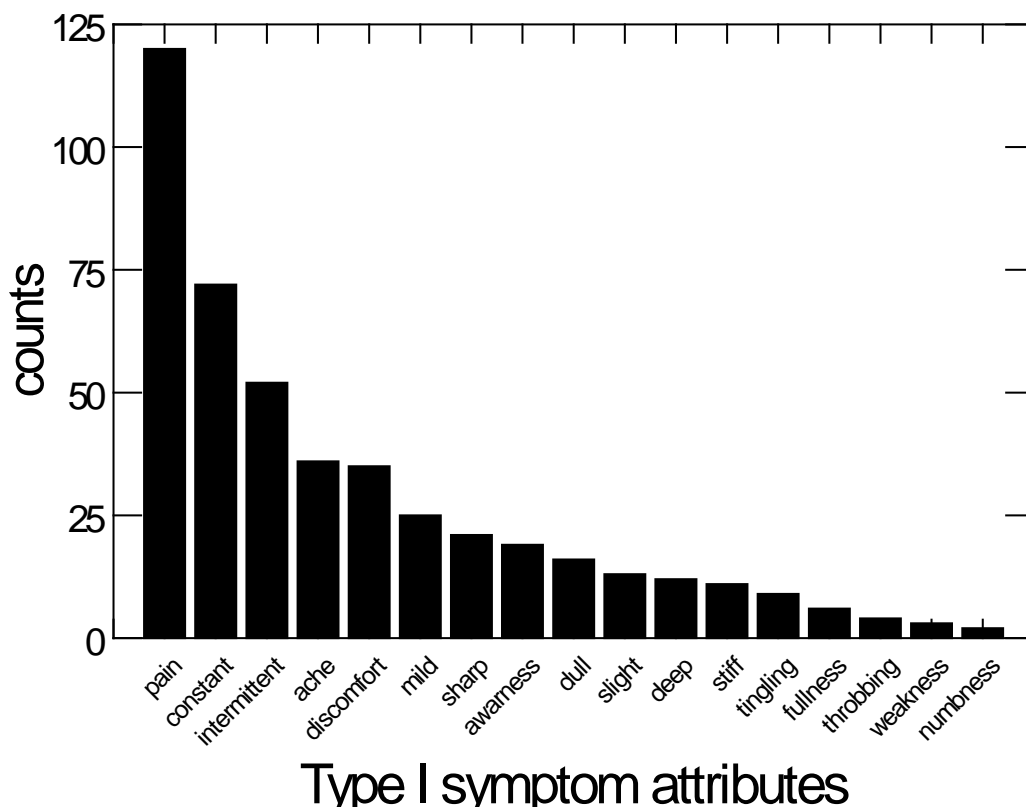
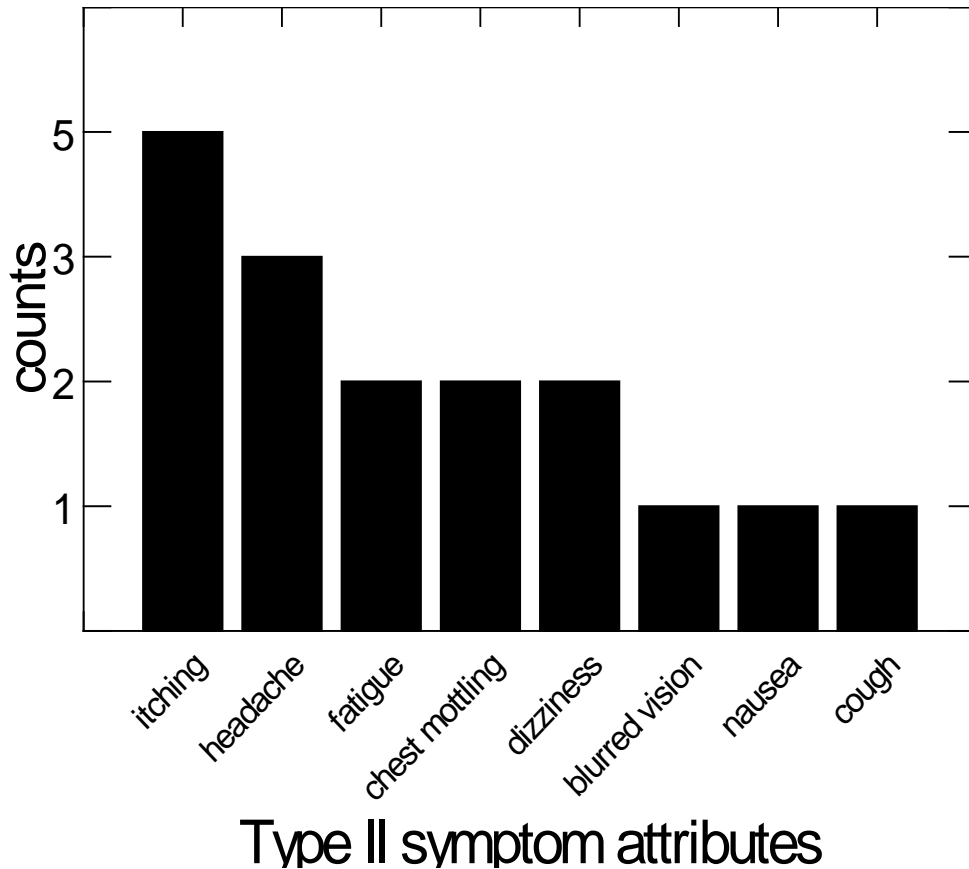

Fig. 11. Locations of 203 symptoms of Type I DCS. Symptoms in toes or fingers were included in feet or hands. One subject had skin symptoms (tingling) in 7 body locations.



**Fig. 12. Counts of 456 symptom attributes. Seven of the 9 records for “tingling” symptoms came from 1 subject. The 2 symptoms of numbness were attributed to impaired circulation and not to neurological causes.**

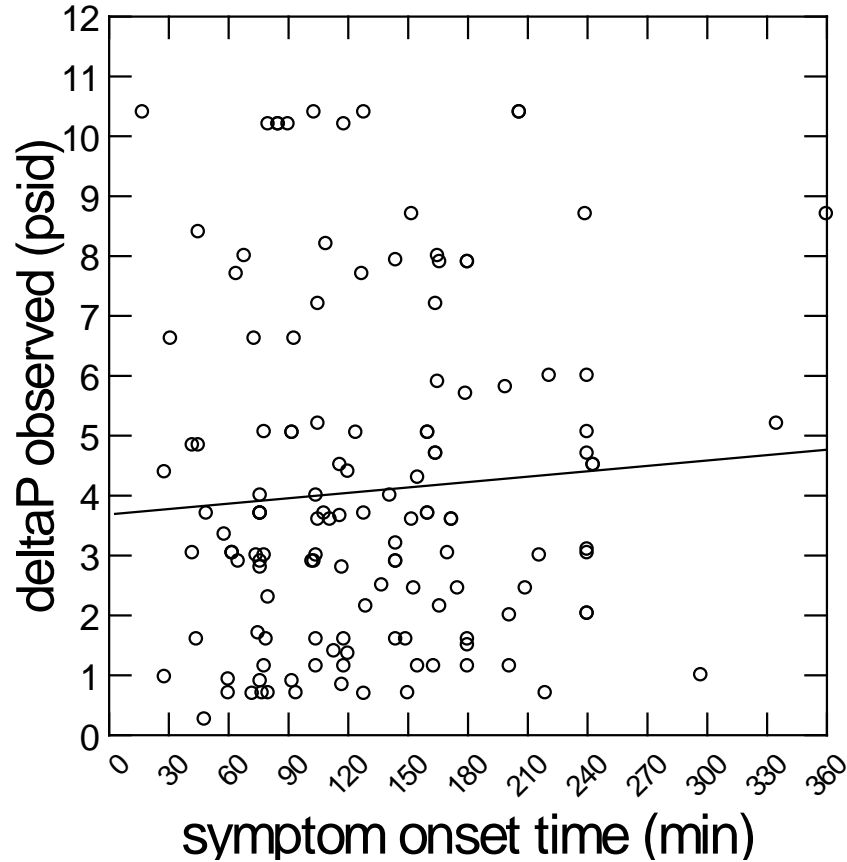

**Fig. 13. Type II DCS symptom attributes. One of the 3 headaches here was classified as Type I DCS. Headache and a sensation of being hot during an otherwise unremarkable 4-h test caused the symptom of “headache” to be classified as Type I DCS in a female subject. However, the subject later reported with Type I symptoms and underwent HBO treatment. Chest mottling (cutis marmorata) was initially classified as Type II DCS at JSC but now exists as its own category of DCS – not Type I or Type II. It is shown on this graph in its historical context.**

## $\Delta P$

Figs. 14 and 15 demonstrate the challenge of describing  $\Delta P$  with available explanatory variables, either an individual variable or combined with others in a multivariable linear regression. Fig. 14 shows that the onset time of a symptom during the hypobaric exposure was not associated with the  $\Delta P$  needed to resolve the symptom. A late report of a symptom did not require less treatment pressure, just as an early report of a symptom did not require more treatment pressure in this analysis. However, we show later that the onset time to report a symptom is useful to estimate the P(symptom resolution).





**Fig. 14. Relationship between the report of DCS symptoms and the  $\Delta P$  for symptom resolution during repressurization to site pressure. The relationship is not impressive. There is no correlation between subsequent  $\Delta P$ s for symptom resolution and onset times in 134 symptoms, a Pearson correlation of only 0.07. The near-horizontal slope indicates best-fit linear regression.**

A delay to repressurization might be expected to increase the  $\Delta P$  to resolve the symptom. However, Fig. 15 shows this is not the case. A persistent or residual symptom did not require a greater treatment pressure, as one might expect. Other variables such as tissue ratio (TR, defined later), age, the bubble growth index (BGI, defined later) at onset of a symptom, or BGI just before repressurization, alone or in combination, did not provide a satisfactory prediction of  $\Delta P$ . So the effort to predict  $\Delta P$  using explanatory variables in a multivariable linear regression was abandoned in favor of a probabilistic approach where  $\Delta P$  is the independent and not the dependent variable.

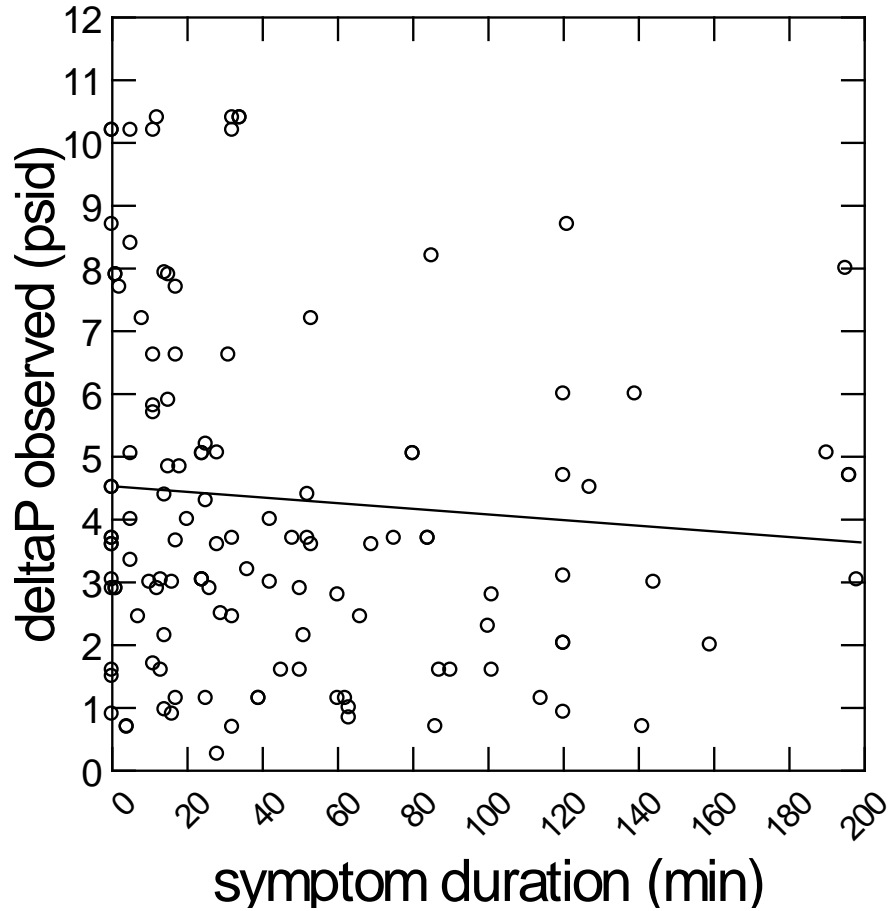

**Fig. 15. Relationship between the duration of 134 symptoms and the  $\Delta P$  for symptom resolution during repressurization to site pressure. There was no relationship, with a Pearson correlation coefficient of only -0.09. Symptom duration is defined as the difference between the elapsed time to the end of the exposure and the elapsed time when the symptom was reported. The near-horizontal slope indicates best-fit linear regression.**

A range of  $\Delta P$ s associated with symptom resolution defines the cumulative proportion of symptoms resolved, as seen in Fig. 16. The  $\Delta P$  data are the empirical representation of a cumulative distribution function (CDF) [ $F_n(\Delta P)$ ].

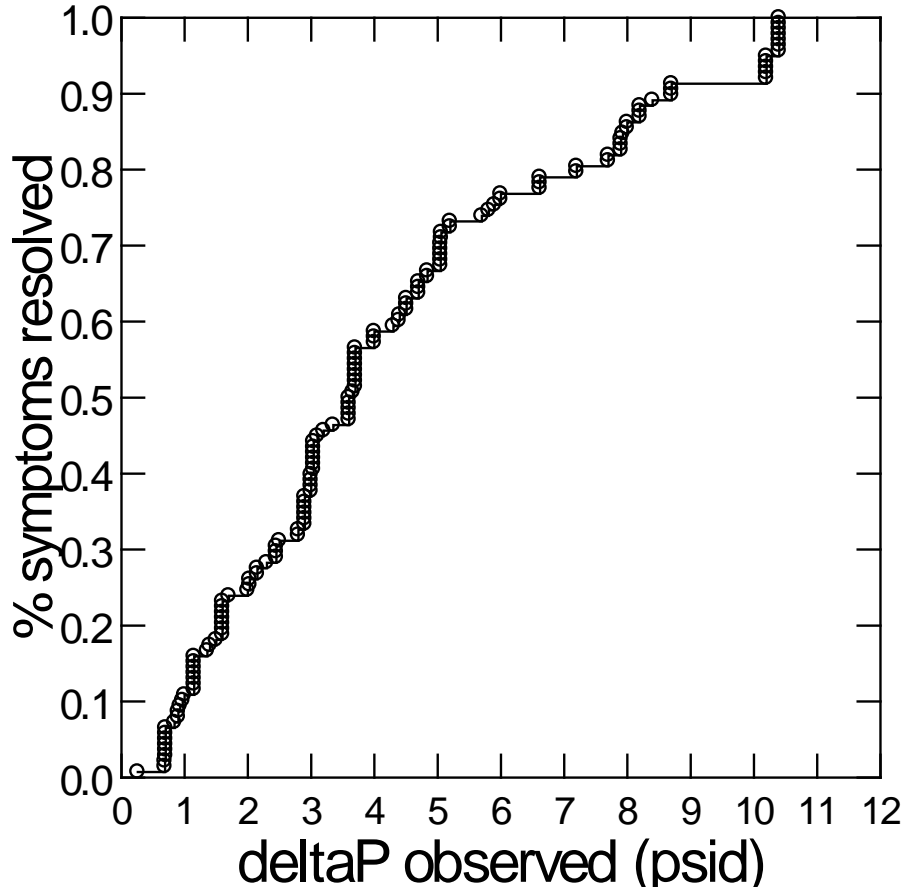

**Fig. 16. Cumulative proportion of 138 symptoms that resolved at the given  $\Delta P$  during or shortly after repressurization to site pressure.**

Fig. 17 shows the totality of information available on  $\Delta P$ , 195 symptoms that resolved either during the hypobaric exposure (37 symptoms with  $\Delta P = 0$ ), during repressurization to site pressure (121 symptoms), while at site pressure (17 symptoms), or during HBO treatment (20 symptoms). Thirty-seven symptoms (19%) resolved at the test altitude before repressurization, 121 symptoms (62%) resolved during repressurization, 17 symptoms (8.7%) resolved at site pressure (between 14.5 and 14.7 psia), and 20 symptoms (10.2%) persisted at site pressure and resolved during a 2.8-ATA HBO treatment. Not represented twice on the figure are 13 symptoms that initially resolved before the subject was released from the test but reoccurred later, or were new symptoms, both of which initiated a 2.8-ATA HBO treatment. Given the lengthy PB provided to NASA subjects, about 90% of 195 symptoms resolved over a  $\Delta P$  of 10.4 psia with about 50% resolution over a  $\Delta P$  of just 3 psia.

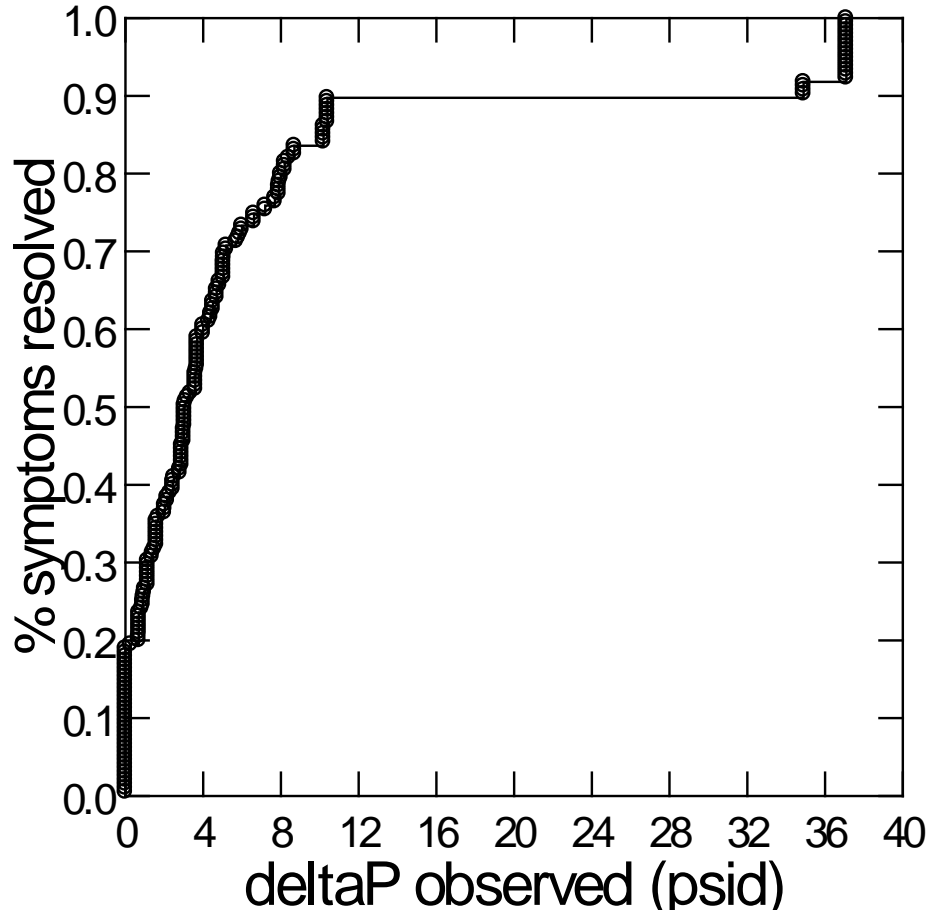

Fig. 17. Cumulative proportion of 195 symptoms that resolved at the given  $\Delta P$ , including symptoms that resolved at the test altitude.

Our aim is to create a probabilistic model for symptom resolution, given (conditional on) that a symptom is present just before repressurization. Therefore, those 37 symptoms that spontaneously resolved during the hypobaric exposure are informative but not germane to our goal. Because 100%  $O_2$  is breathed during EVA, an evolved gas phase is simultaneously growing and resolving, and the balance of the 2 processes at any given moment is the offending gas phase. Given enough time and the disposition to tolerate a symptom, the gas phase will eventually resolve along with the symptom. We do not consider this approach a prudent treatment option, so the 37 symptoms that resolved without repressurization are excluded from the treatment model. Resolved symptoms do not need a treatment intervention.

Fig. 18 shows the cumulative proportion of 158 symptoms that resolved under a positive  $\Delta P$ . Fig. 18 depicts the empirical mixture CDF over all values of the covariates in the data set. Of the 158 symptoms, 121 resolved during repressurization (76.5%), 17 (10.7%) resolved at site pressure (between 14.5 and 14.7 psia), and 20 (12.6%) persisted at site pressure and resolved during a 2.8-ATA HBO treatment. Also not represented on the figure are symptoms that reoccurred later, after the subject was released, or symptoms that were new, both of which initiated an HBO treatment.

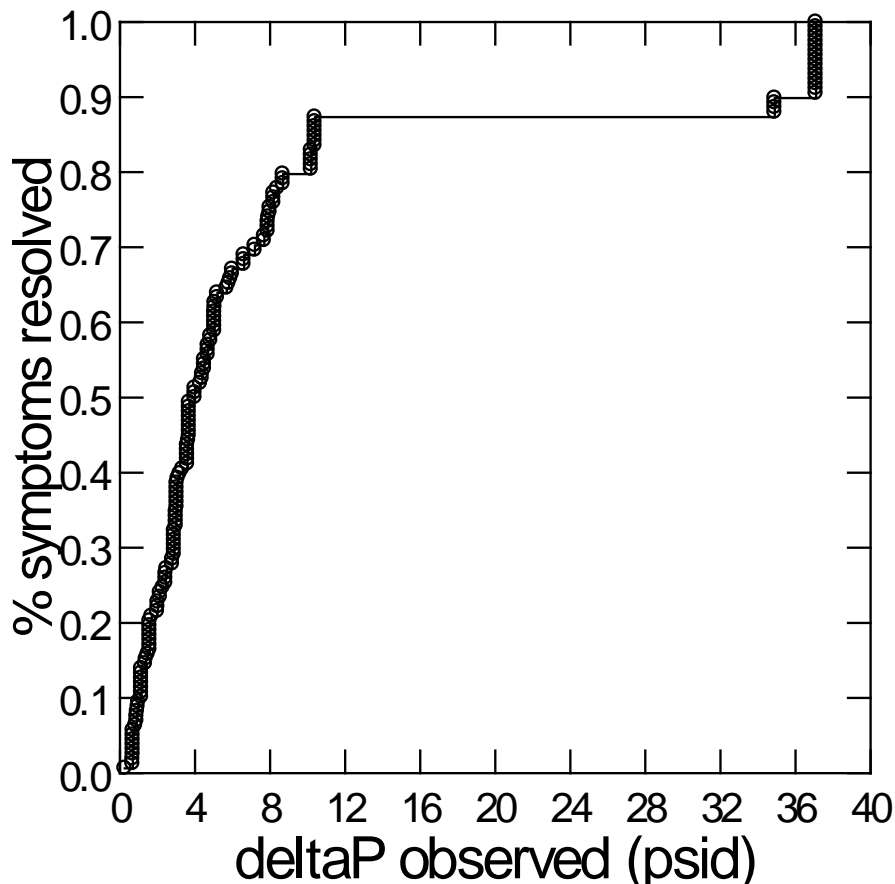

Fig. 18. Cumulative proportion of 158 symptoms that resolved at the given  $\Delta P$ , including symptoms that required HBO treatment.

The  $\Delta P$ s from 121 symptoms that resolved during repressurization, which are similar to the Muehlberger *et al.* (2004) data in Fig. 1, and the 17 symptoms that resolved shortly after reaching site pressure are explicit since the subject reported when the symptom(s) cleared and the investigator documented the corresponding  $\Delta P$ . The remaining 20 symptoms were persistent or residual at site pressure and compelled the MO to initiate an HBO treatment to resolve the symptom. However, the  $\Delta P$ s associated with HBO treatment are not explicit, but are interval censored. HBO treatment is a clinical intervention, not intended to further our detailed understanding of symptom resolution. The HBO treatment was to 2.8 ATA (approximately corresponding to  $\Delta P = 37$  psid for exposures conducted at 4.3 psia), regardless of when the symptom resolved during pressurization to 2.8 ATA. In other words, the subjects were not titrated to a  $\Delta P$  that resolved the symptom; instead, they underwent a standard-of-care HBO treatment originally designed to treat divers with DCS. Thus, the 20  $\Delta P$ s associated with a standard HBO treatment are considered interval-censored observations in the regression of the treatment model since we do not know the precise  $\Delta P$  that the symptom resolved.

## HBO Treatment and Recurrent Symptoms

The treatment model does include the  $\Delta P$  for initial symptom resolution in those few subjects with a recurrent symptom, but it does not include the  $\Delta P$  for HBO treatment for recurrent symptoms. Sufficient details are not available about symptoms that reoccurred after the subject was released from the test and that subsequently required HBO treatment. Recurrent symptoms are those that resolved before the subject was released from the test by the MO but reoccurred hours to days later. Late symptoms are new symptoms that never appeared during the test but appeared hours to days later and were treated with HBO. Symptoms reported days after a hypobaric exposure are always suspect as being attributable to a persistent gas phase. But these few cases were always treated with HBO and the subjects reported improvement or complete relief, be it through a placebo effect or some real benefit from HBO. The uncertainty and lack of details about recurrent and late symptoms prevent their inclusion in our treatment model. Also, prophylactic HBO treatment pressure is not included in the treatment model. There was no imminent reason to treat symptoms that resolved before or during GLO at site pressure with HBO. However, the judgment of the MO in several cases was to treat a nonsymptomatic subject, primarily to reduce the chance of a recurrent symptom hours or days later. Not all symptoms classified as Type II DCS automatically received HBO treatment. In several cases a prompt return to site pressure followed by GLO with the absence of symptoms at site pressure was deemed sufficient treatment by the MO.

Symptoms classified as Type I DCS that were persistent or residual at site pressure did receive HBO treatment. The treatment model does include HBO treatment pressure for 20 symptoms that were persistent at site pressure, which were referred to HBO treatment with or without previous GLO. Persistent symptoms at site pressure that were referred for HBO treatment are classified as interval-censored observations in our statistical analysis since the precise pressure at which the symptom resolved was not available; the only treatment pressure available was the 41 psia (2.8 ATA) provided by a TT V or VI.

Table IV lists all subjects who experienced an HBO treatment and provides summary information about the symptoms that precipitated the decision to treat with HBO. There were 46 symptoms associated with 24 subjects who received HBO treatment; not all symptoms were present at the start of HBO treatment. In several cases a prophylactic HBO treatment was provided for symptoms that resolved and were not present at the start of the HBO treatment. Only 9 subjects had symptoms that were persistent at site pressure. It is notable that of the 20 symptoms that persisted at site pressure, 9 symptoms were from 2 subjects: D980714C and D030327A (see Appendix III for details). The lack of information from case descriptions about some symptoms, either the same recurring symptom or a new symptom, prevented their inclusion in the treatment model.

Table IV. NASA Hyperbaric Oxygen Treatments

subject ID	persistent symptom(s) at site pressure	symptom(s) resolved before or at site pressure	new or recurrent symptom(s) hours to days later	one symptom as Type II	HBO treatment table	HBO used in DCS treatment model
34-01	0	1	1	0	V	0
34-02	0	1 at site	1	0	V	0
121-01	1	0	0	1	VI	1
138-01	0	1	1	0	V	0
133-02	0	1	1	0	V	0
149-01	1	0	0	1	V	1
136-01	0	1	1	0	VI	0
182-01	1	0	0	1	V	1
D980113C	0	1	0	0	V*	0
D980120B	0	1	1	0	VI**	0
D980203B	0	1	1	0	VI**	0
D980210A	unknown	unknown	1	0	VI**	0
D980303B	1	0	0	0	VI	1
D980714C	1	0	0	1	VI	1
H990615B	0	1	1	0	V**	0
D030327A	1	0	0	1	VI	1
D030825B	1	0	0	0	V	1
D031009B	0	1	0	0	V*	0
D031106B	1	0	0	0	V	1
D040817B	1	0	0	0	V	1
D040831A	0	1	0	0	V*	0
D040915A	0	1	0	0	V*	0
D070515A	0	1	0	0	V*	0
D070821A	0	1	0	0	V*	0

\*Prophylactic HBO treatment – no post-exposure symptom to treat.

\*\*New symptom(s) post-test was not first reported during test.

## P(symptom resolution)

The P(symptom resolution) during repressurization was modeled as an interval-censored log-logistic function of pressure difference ( $\Delta P$  as psid) for symptom resolution and other explanatory variables while accounting for multiple symptoms (dependency) within subjects, using STATA<sup>®</sup> version 13 software (StataCorp 2013). All symptoms resolved at a particular  $\Delta P$ ; however, subjects were not titrated to a  $\Delta P$  that resolved 20 symptoms during HBO treatment. We accounted for multiple symptoms in some subjects (dependency) by incorporating robust standard error calculations in the treatment models (Royall 1986).

A brief description of the regression model starts with the log-logistic survival function  $S(x)$ :

$$S(x) = 1 - [ 1 / ( 1 + \exp(-\omega) ) ], \quad \text{Eq. 5}$$

where  $\omega = [\ln(x) - \beta_2] / \beta_1$  and  $x$  is  $\Delta P$  in our application. With Eq. 5, as  $\Delta P$  increases the probability of unsuccessful treatment decreases.

The distribution is specified with 2 parameters and generalized to include the effects of covariates (explanatory variables) on  $\Delta P$ . The generalized log-logistic is called an accelerated model in which the logarithm of  $\Delta P$  is a linear function of the covariates:

$$\omega = [\ln(\Delta P) - \beta_2 - \beta_{x1} \times x_1 - \dots - \beta_{xn} \times x_n ] / \beta_1. \quad \text{Eq. 6}$$

Our preference to graph the log-logistic function is as the CDF  $F(x)$ :

$$F(\Delta P; z) = 1 - S(\Delta P; z) = 1 / ( 1 + \exp(-(\ln(\Delta P) - \beta_2 - \beta_{x1} \times x_1 - \dots - \beta_{xn} \times x_n) / \beta_1) ), \quad \text{Eq. 7}$$

where  $F(\Delta P; z)$  indicates the accelerated log-logistic model, and now as  $\Delta P$  increases the probability of successful treatment increases, our P(symptom resolution).

We start our evolution to the final treatment model by first understanding the contribution of the limited HBO treatment information. Fig. 19 shows the results of adding the 20 censored HBO treatment data points to 138 symptoms that resolved during repressurization and shortly after reaching site pressure in a regression with just  $\Delta P$  (univariate). The regression curve predicts almost complete symptom resolution at a  $\Delta P$  of 37 psid, which is our experience. All symptoms resolved during HBO treatment at  $\leq 41$  psia. The regression primarily reflect the contribution from ambulatory male subjects: 90 symptoms were from ambulatory and 33 from nonambulatory men compared to 12 from ambulatory and 23 from nonambulatory women.



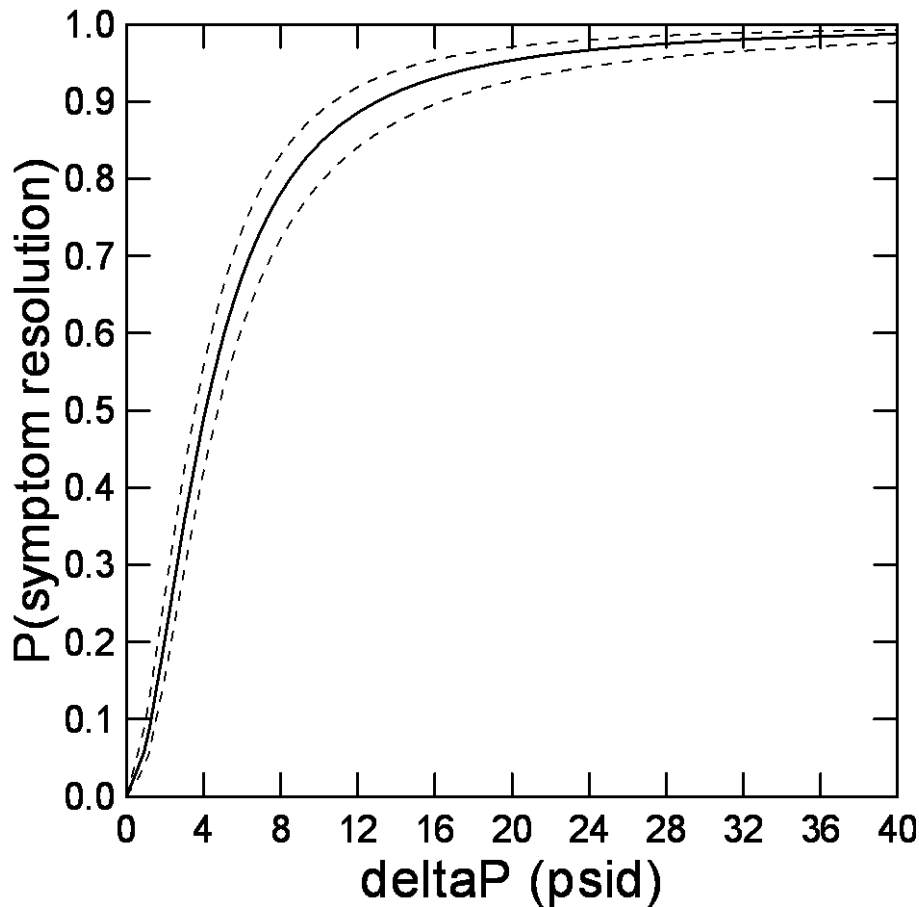

Fig. 19. P(symptom resolution) based on 158 symptoms that resolved at a  $\Delta P$  between 0 and 37.1 psid.  $P(\text{symptom resolution}) = 1 / (1 + \exp(-(\ln(\Delta P) - 1.411) / 0.524))$ , plus 95% upper and lower CL, assuming independence among symptoms.

An alternative regression is to select only the 138 symptoms that resolved during repressurization and shortly after reaching site pressure as the basis of the treatment model, then *extrapolate* to a P(symptom resolution) when  $\Delta P$  is  $> 11$  psid. Fig. 20 shows the regression results from data seen in Fig. 16 with the regression curve extrapolated to a  $\Delta P$  of 40 psid. Note that the extrapolated curve shows that symptom resolution at 40 psid is near 100% certainty, without considering the lower 95% confidence limit (CL). Also, the P(symptom resolution) is near 0.93 at site pressure, which reflects the reality that not all symptoms promptly resolve on repressurization to site pressure.

On balance, the regression results in Fig. 20 are more in accord with our experience than those in Fig. 19, given no explanatory variables in the regression. An *extrapolation* from 10.4 psid to about 40 psid provides an estimate of the additional  $\Delta P$  needed to resolve a symptom that does not promptly resolve at site pressure. As before, the regression primarily reflects the contribution from ambulatory men: 87 symptoms were from ambulatory and 23 from nonambulatory men compared to 12 from ambulatory and 16 from nonambulatory women.

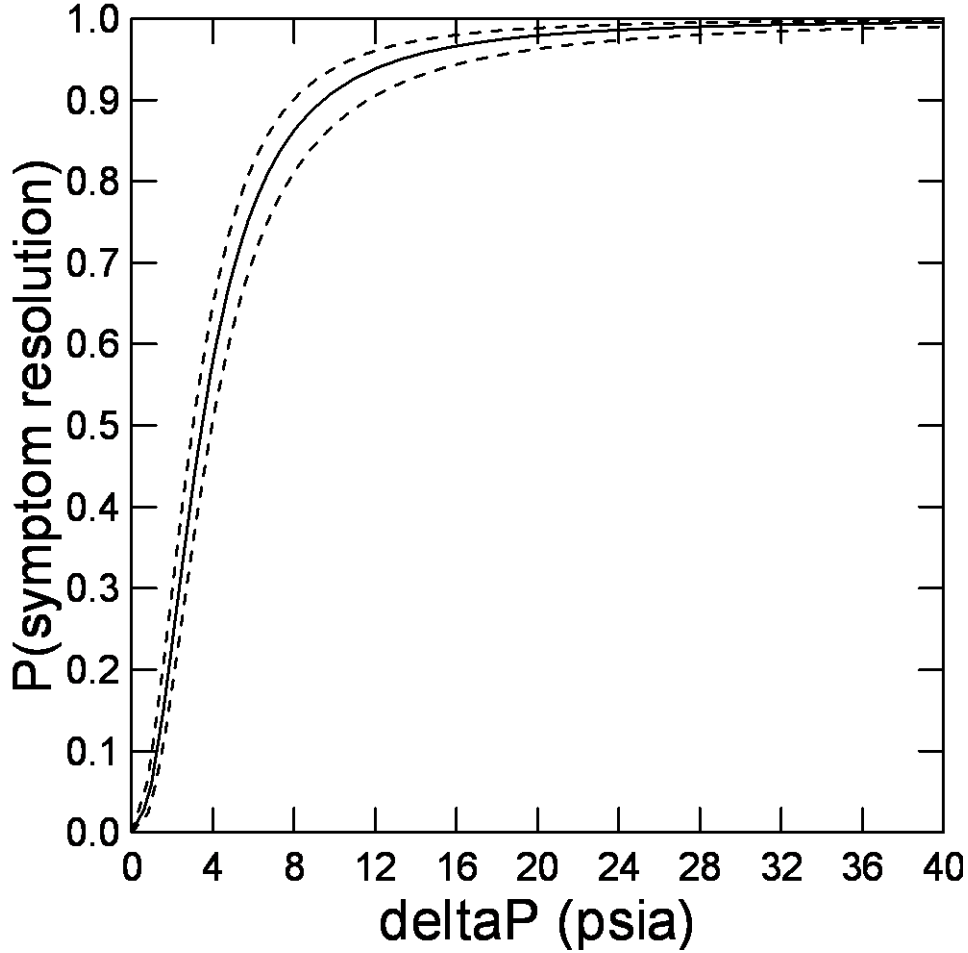

Fig. 20. P(symptom resolution) based on 138 symptoms that resolved at a  $\Delta P$  between 0 and 10.4 psid.  $P(\text{symptom resolution}) = 1 / (1 + \exp(-(\ln(\Delta P) - 1.239) / 0.457))$ , plus 95% upper and lower CL, assuming independence among symptoms.

We decided to keep the censored  $\Delta P$ s from HBO treatment in the treatment model and included explanatory variables that improved the treatment model. This approach eliminates the uncertainty (false certainty) of *extrapolating* the treatment model into a significant range of HBO. Even the 20 censored HBO symptoms provide some information to the treatment model, making it more conservative [lower P(symptom resolution)] at  $\Delta P$ s > 11 psid. The final form of the treatment model is described after first providing a necessary description of how effective treatment pressure ( $\Delta P$ ) is computed from the TBDM, a related discussion about the O<sub>2</sub> window, a brief description of the TBDM, and descriptions of DCS and VGE survival models for all NASA data to date. The background information is needed to properly interpret the P(symptom resolution) from the final treatment model.

### Computing Effective Treatment Pressure

Eq. 8 is Boyle's law for an isothermal system with a fixed amount of ideal gas (closed system).

$$P_1 \times V_1 = P_2 \times V_2,$$

Eq. 8

where  $V_1$  is dry-gas volume at pressure  $P_1$  and  $V_2$  is dry-gas volume at pressure  $P_2$ . The ratio of  $V_1$  to  $V_2$  is equivalent to the ratio of  $P_2$  to  $P_1$ . An initial unit volume of dry gas ( $V_1$ ) is reduced by half when initial pressure ( $P_1$ ) doubles. Eq. 9 is Eq. 8 solved for  $\Delta P$ . The pressure difference ( $\Delta P$ ) in this example is 1 unit. An increase of 1  $\Delta P$  unit results in 50% reduction in initial ideal gas volume.

$$P_2 - P_1 = \Delta P = V_1/V_2 \times P_1 - P_1. \quad \text{Eq. 9}$$

The volume of a sphere is

$$V = \frac{4}{3}\pi r^3. \quad \text{Eq. 10}$$

The TBDM accounts for the time-dependent change in the mass of  $N_2$  during compression and during the final reabsorption of the bubble. In the TBDM, the radius per unit volume of tissue that a spherical bubble achieves through time was computed for a particular PB protocol, ascent rate, exposure duration, and repressurization condition. Radii at the time of repressurization and at the time the symptom was resolved were converted to respective gas volumes through Eq. 10. Volumes in the TBDM were expressed at body temperature ( $37^\circ\text{C}$ ), ambient pressure, and dry-gas conditions (BTPD). Boyle's law dominates the volume change during any short repressurization because of the limited diffusion of  $N_2$  and metabolic gases out of the bubble in a short period of time. The very small loss of  $N_2$  during a short repressurization to site pressure, as well as the continued loss of  $N_2$  in a bubble driven by the magnitude of the  $O_2$  window, and other factors that influence bubble  $N_2$  partial pressure ( $P_{\text{bub}N_2}$ ) contribute to the final volume reduction through time. The reduction in bubble volume is the treatment potential for a DCS symptom. *Our underlying assumption is that given the reduced volume, the computed  $\Delta P$  from Eq. 9 is the effective treatment pressure at any point in time because the TBDM is time-dependent.*

The observed  $\Delta P$  to resolve a symptom must be very close to the computed  $\Delta P$  with Eq. 9 since the TBDM incorporates Boyle's law for ideal gas. Fig. 21 shows the observed  $\Delta P$  to resolve 138 symptoms during repressurization and at site pressure on the x-axis and the computed  $\Delta P$  on the y-axis, applying Eq. 9 to the initial and final BGIs from the TBDM. BGI is a unitless index of bubble growth, defined as the ratio of bubble radius at some time  $t$ , usually the beginning of a repressurization, to an initial stabilized micronuclei radius of 3 micrometers ( $\mu\text{m}$ ). BGI was first converted back to bubble radius as  $\text{BGI} \times 3$  at a point in each record where repressurization commenced and where the symptom resolved during the repressurization. Both radii were then converted to volumes through Eq. 10, and to the computed  $\Delta P$  through Eq. 9. Computed volumes for 20 symptoms from 9 subjects who needed HBO are not included in Fig. 21. The details needed to compute volume with the TBDM were unavailable, such as time at site pressure before HBO, breathing gas composition before HBO, and time during HBO treatment for symptom resolution. The agreement between observed  $\Delta P$  and computed ideal gas  $\Delta P$  from Boyle's law in Fig. 21 is evident in the linear regression result:  $\Delta P_{\text{computed}} = 1.0016 \times \Delta P_{\text{observed}} - 0.324$ , with  $r^2 = 0.977$ .

All 138 data points should fall on the identity line if only Boyle's law is represented. Slight deviations from the identity line are expected because the computed volume at symptom resolution is from a time-dependent open system and Eq. 9 applies to a closed system. It is enough to conclude from Fig. 21 that Boyle's law for ideal gas, applied to the TBDM over the short repressurization times, is the dominant factor to account for symptom resolution.

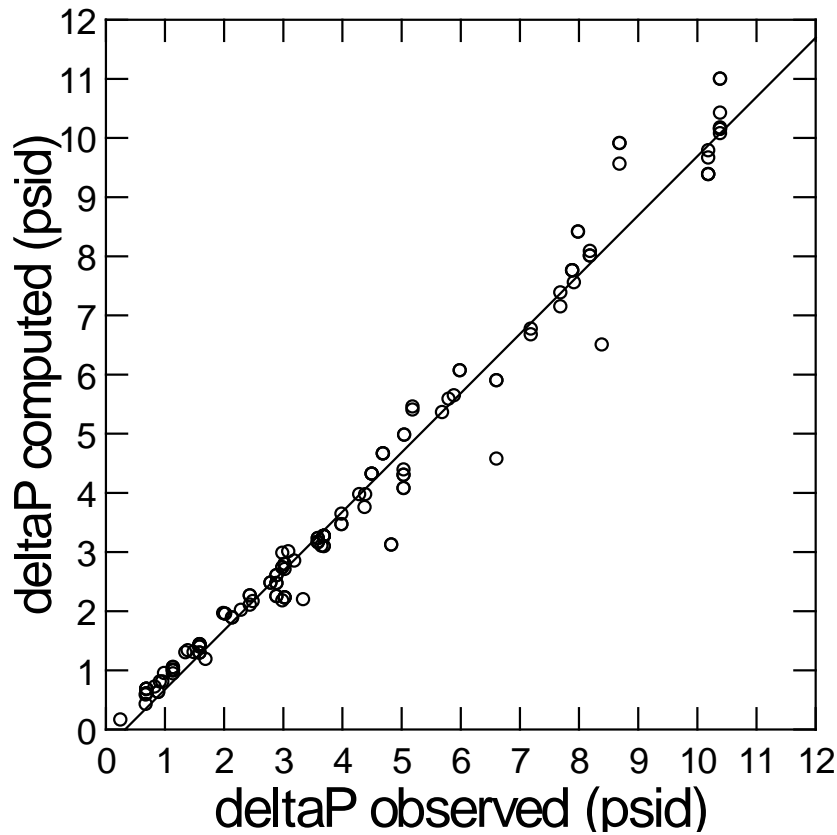

Fig. 21. Observed  $\Delta P$  to resolve 138 symptoms compared to the computed  $\Delta P$  based on Eq. 9.

A change in ambient pressure is transmitted equally through all tissues; living tissues are in equilibrium with the prevailing hydrostatic pressure. Therefore, a volume of wet gas in the tissue is subject to change with a change in ambient pressure. An important distinction between dry and wet gas is made in the application of Boyle's law. All natural or accidental voids in the body at 37°C are in equilibrium with water vapor partial pressure of 47 mmHg. Water is a liquid at body temperature and water vapor is a dispersed liquid phase. In contrast to other gases in a bubble, saturated water vapor at one temperature will condense out of the gas phase at a lower temperature. The maximum partial pressure of water in a saturated wet gas is equal to the vapor pressure of water at 37°C. Because water vapor partial pressure is constant at a given temperature regardless of pressure, it is subtracted from total pressure when applying Boyle's law to wet gas. The noncompressibility of water vapor causes wet gas to respond differently to pressure changes than dry gas (Stepanek 2002).

Eq. 11 is Boyle's law with reference to wet gas

$$P_1 - PH_2O \times V_1 = P_2 - PH_2O \times V_2. \quad \text{Eq. 11}$$

Solving Eq. 11 for  $P_2 - P_1$ , the  $\Delta P$  associated with a volume change of wet gas, yields Eq. 12:

$$P_2 - P_1 = \Delta P = V_1/V_2 \times (P_1 - PH_2O) + PH_2O - P_1. \quad \text{Eq. 12}$$

We converted all  $V_1$  and  $V_2$  pairs from BTPD to gas volume expressed under body temperature ( $37^\circ\text{C}$ ), ambient pressure, and saturated water vapor (47 mmHg) conditions (BTPS) by multiplying BTPD volumes by the ratio  $P_B / (P_B - PH_2O)$  to apply Eq. 12. Fig. 22 shows the same data as in Fig. 21 except the computed  $\Delta P$  was from Eq. 12 after dry gas volumes from the TBDM were corrected for wet gas. So  $V_1$  becomes the volume of a spherical bubble under BTPS conditions in a unit volume of tissue at low pressure  $P_B = P_1$ ,  $V_2$  is volume under BTPS conditions after a change to a higher pressure  $P_B = P_2$ , and  $PH_2O$  at  $37^\circ\text{C}$  is 0.909 psia. Now the ratio of  $V_1$  to  $V_2$  is not equivalent to the ratio of  $P_2 - PH_2O$  to  $P_1 - PH_2O$ . Given the same change in pressure there is a slightly greater volume expansion during a depressurization and a slightly greater volume compression during repressurization compared to the ideal gas application of Boyle's law. The results are essentially identical in Fig 22 and Fig 21, as is evident in the linear regression result:  $\Delta P_{\text{computed}} = 0.999 \times \Delta P_{\text{observed}} - 0.28$ , with  $r^2 = 0.980$ .

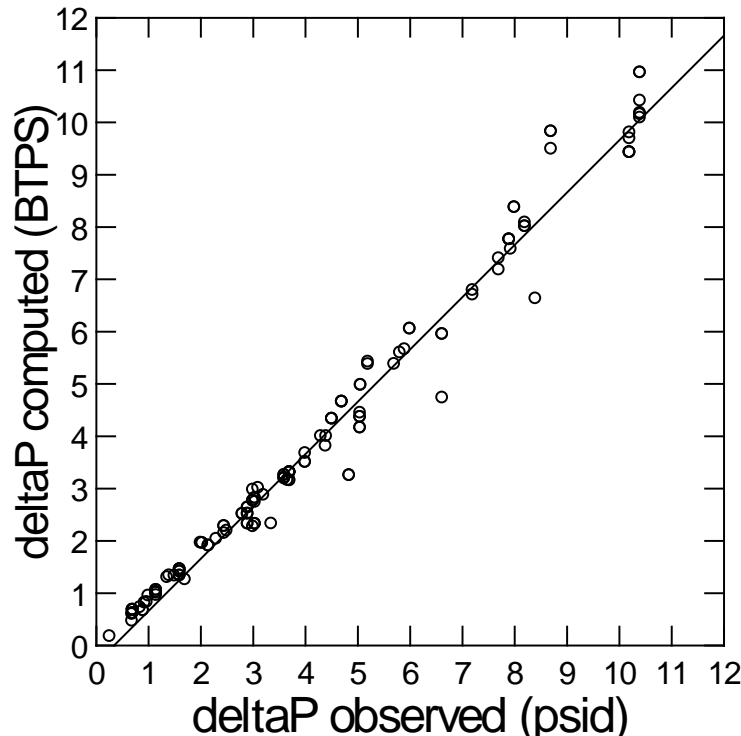

Fig. 22. Observed  $\Delta P$  to resolve 138 symptoms compared to the computed  $\Delta P$  based on Eq. 12.

As long as Eq. 9 is used in conjunction with  $V_1$  and  $V_2$  outputs from the TBDM, then it is valid to create a predictive model for symptom resolution based on effective treatment pressure acting on

ideal gas volumes. The  $dr/dt$  equation includes radius on the right side of the equation, so the actual radius of the changing bubble has an impact on  $dr/dt$ . Therefore, the subsequent decrease in  $V_2$  from the loss of  $N_2$  after the repressurization event in a smaller bubble is different if ideal gas volume is used in place of corrected wet-gas volume. Smaller bubbles derive 2 benefits from a highly curved surface: a) the surface force, along with the smaller radius of curvature, results in a greater internal pressure due to surface tension, thus increasing partial pressures of all gases within the bubble and increases the outward diffusion, and b) the curved surface results in a greater divergence of the gas flux lines and therefore a more rapid drop in partial pressure with increasing distance from the surface, raising the partial pressure difference and the rate of gas efflux.

Other bubble-tissue model systems (Van Liew & Hlastala 1969, Van Liew & Burkard 1995, Srinivasan *et al.* 2003, Gerth & Vann 1997, Tikuisis *et al.* 1994, Nikolaev 2013, and Srinivasan & Gerth 2013) can be used to compute the effective treatment pressure change using Eq. 9 or 12 if the TBDM is not available to a user of the treatment model. This is because the  $\Delta P$  data on symptom resolution are independent of the bubble-tissue model system to compute an effective treatment pressure change through time. The user computes the effective treatment pressure for any bubble-tissue model and takes the result to a statistical regression of empirical data that relates the observed  $\Delta P$  to the P(symptom resolution). The treatment model links a decrease in computed bubble volume to the P(symptom resolution). The decrease in volume is realized in 2 stages: a) during compression due to Boyle's law and b) during subsequent dissolution of the gas phase by the  $O_2$  window. The computed  $\Delta P$  is the effective treatment pressure at any point in time.

Fig. 23 is an example of Eq. 11 applied to instantaneous volume reduction in an astronaut and diver seeking relief from a symptom. The figure shows the reduction in a unit volume of wet gas with the application of sea level pressure (1 ATA) to gas at 0.29 ATA from an astronaut and application of HBO pressure (2.8 ATA) to gas at 1.0 ATA from a diver. The noncompressibility of water vapor causes wet gas to respond differently to pressure changes than dry gas. For example, a unit volume of dry gas taken from 760 mmHg to 140 mmHg (40,000 ft altitude) would experience a 5.4-fold volume expansion using Eq. 8. Application of Boyle's law with reference to wet gas requires that 0.0618 ATA (47 mmHg) water vapor pressure be removed from the initial and final pressures, yielding a 7.6-fold volume expansion using Eq. 11. A unit volume of wet gas taken as 100% in the aviator would decrease to 24% on repressurization from 0.29 ATA to 1.0 ATA after removing 0.0618 ATA water vapor pressure from the initial and final pressures. The diver experiences a reduction to 34% of the unit volume on repressurization from 1.0 ATA to 2.8 ATA. So in this example there is an advantage in the hypobaric case compared to the hyperbaric case when considering volume decrease during repressurization. A more extensive analysis with the same conclusion, based on a dry-gas application (Eq. 8) of Boyle's law, was reached by Dart & Butler (1998), their Fig. 3.

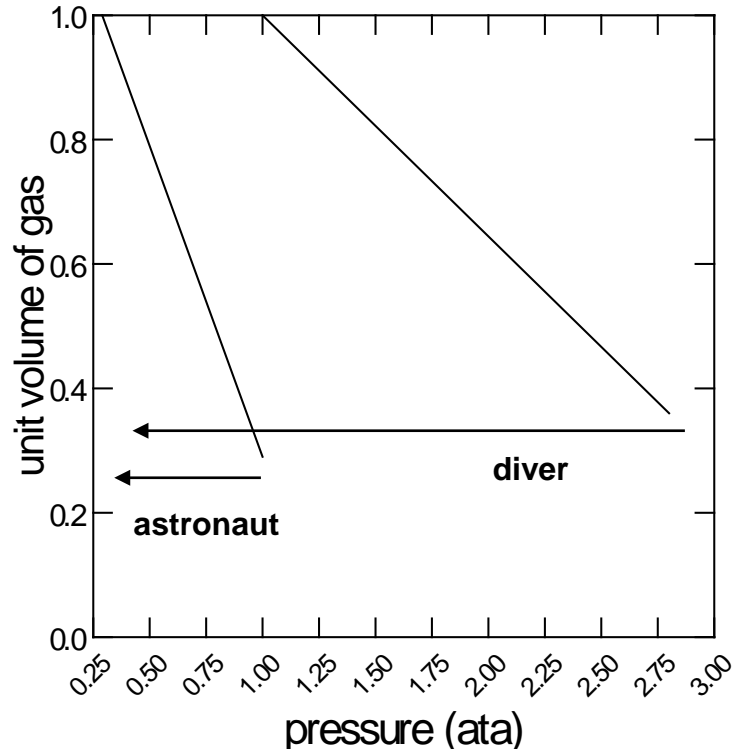

**Fig. 23. Comparison of astronaut and diver repressurizations. An astronaut enjoys a slight advantage from Boyle's law compression of an offending gas phase at 0.29 ATA while returning to 1 ATA compared to a diver given an HBO treatment for the same gas phase at 2.8 ATA.**

A second example highlights the significant gas volume reduction with small  $\Delta P$  when the gas phase is present at a low absolute ambient pressure. We compare the unit volume reduction in an astronaut who returns to the ISS at 14.7 psia while still pressurized at 4.3 psid in the spacesuit to the equivalent depth that a diver needs to achieve for the same unit volume reduction. The wet-gas reduction using Eq. 11 for the astronaut is from 1.0 ml to 0.18 ml at 19.0 psia while the diver must pressurize to 74.5 psia for the same volume reduction, a pressurization equivalent to treatment at 134 fsw.

Boyle's law is a major factor but not the only factor to consider for effective DCS treatment. Due to the presence of a constant metabolic gas partial pressure, the  $N_2$  partial pressure of astronaut and diver bubbles is different. The reabsorption of the bubbles during the application of pressure while breathing 100%  $O_2$  is dictated by the  $N_2$  partial pressure gradient between the bubbles and mixed venous blood  $N_2$  tension, a reflection of tissue  $N_2$  tension. It could be that the  $N_2$  gradient is greater for the astronaut than for the diver, as the astronaut breathes 100%  $O_2$  for several hours as DCS evolves compared to the diver who was breathing air during and after the dive.

Fig. 24 demonstrates the combination of Boyle's law and the removal of  $N_2$  from a bubble-tissue open system to resolve a symptom as modeled by the TBDM. The first curve from the left shows the BGI after a 60-min PB in an astronaut exposed to 4.3 psia (0.29 ATA) with return to 14.7 psia, the second curve shows the BGI in a saturation diver with return to 41.1 psia (2.8

ATA) after exposure to 14.7 psia, and the third curve shows the BGI is after a 300-min PB in an astronaut exposed to 4.3 psia with return to 14.7 psia (5 min for all pressure transitions).

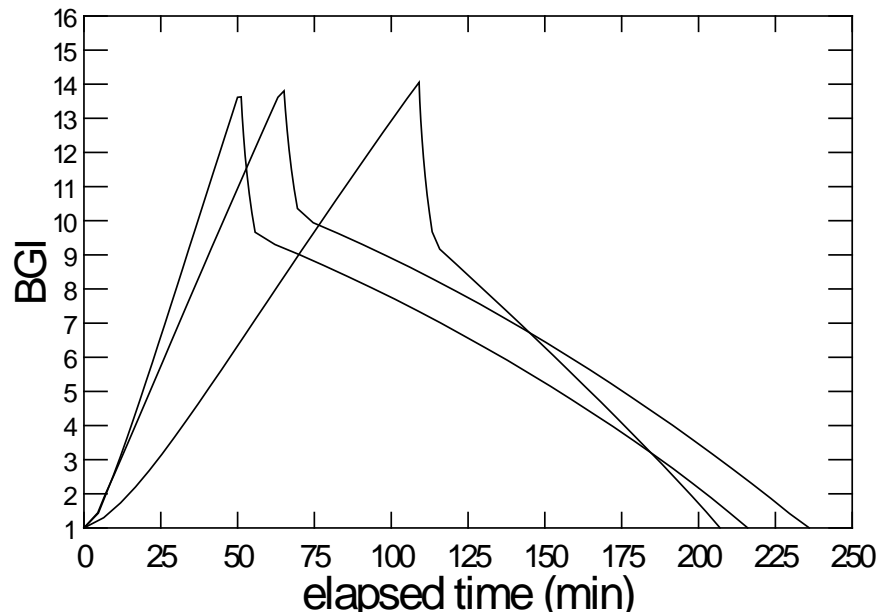

**Fig. 24. Examples of bubble growth and dissolution using the TBDM. Three examples demonstrate the resolution of BGI = 14 given a Boyle’s law decrease in bubble volume with applied treatment pressure and the bubble-to-tissue N<sub>2</sub> gradient as computed with the TBDM.**

The elapsed time from the start of decreased pressure (time 0) to bubble resolution is longer for the saturation diver (236 min) than for the astronauts (207 and 216 min), for whom the elapsed time depends on the PB time. The difference results from a slight Boyle’s law advantage for the astronaut with the longer PB during the return to site pressure (14.7 psia for astronaut and 41.1 psia for saturation diver) combined with a greater bubble-to-tissue N<sub>2</sub> gradient.

A tentative conclusion based on 3 examples and multiple assumptions in the TBDM is that the time needed to resolve a theoretical bubble is shorter for an astronaut treated with 100% O<sub>2</sub> at 1 ATA than the time needed for a saturation diver treated with 100% O<sub>2</sub> at 2.8 ATA (the diver’s saturation pressure, and the treatment pressure for the USN TT V). One other complication for the diver is the high pO<sub>2</sub> during treatment, a level that is reduced during air breaks to prevent CNS or pulmonary O<sub>2</sub> toxicity. This complexity was not included in the simulation and is not a complexity that the astronaut must face, as 100% O<sub>2</sub> at 1 ATA is tolerable for several hours.

## O<sub>2</sub> Window and Bubble Dissolution

A volume of any gas introduced into living tissue eventually dissipates. An understanding of the absorption mechanism is necessary to ultimately understand the resolution of a DCS symptom. The following discussion is based on a clear description of the O<sub>2</sub> window by Van Liew *et al.* (1993) (also Van Liew *et al.* 1995), and is required reading for those responsible for DCS treatment.



The sum of gas tensions in mixed venous blood under steady-state sea level (1 ATA breathing air) conditions is not equal to the sum of alveolar gas partial pressures ( $P_{AX}$ ). Alveolar gas partial pressures at sea level are 40 mmHg for  $CO_2$ , 103 mmHg for  $O_2$ , 570 mmHg for  $N_2$  (including 1% argon in breathing air as  $N_2$ ), and 47 mmHg for  $H_2O$ , summing to 760 mmHg. Mixed venous blood tensions, a reflection of whole-body tissue tensions ( $P_{tisX}$ ), are 45 mmHg for  $CO_2$ , 40 mmHg for  $O_2$ , 570 mmHg for  $N_2$ , and 47 mmHg for  $H_2O$ , summing to 702 mmHg. The difference of 58 mmHg is termed inherent unsaturation, partial pressure vacancy, or most commonly the  $O_2$  window. Eq. 13 defines the  $O_2$  window ( $P_w$ ) as

$$P_w = P_B - (P_{tisN_2} + P_{tisO_2} + P_{tisCO_2} + PH_2O). \quad \text{Eq. 13}$$

Gas partial pressures in bubbles ( $P_{bubX}$ ) *approach* equilibrium with gas tensions in tissues, where  $P_{tisO_2}$  and  $P_{tisCO_2}$  are constant because of metabolic control over tissue gas exchange and rapid diffusion across the bubble-tissue boundary. The total of all gas partial pressures, including  $PH_2O$  of 47 mmHg at 37°C, in a bubble must sum to the ambient pressure ( $P_B$ ) or an even higher bubble pressure ( $P_{bub}$ ) that includes  $P_B$  in accordance with Dalton's law of partial pressure. Therefore,  $P_{bubN_2}$  is eventually larger than  $P_{tisN_2}$  in living tissues, resulting in diffusion of  $N_2$  from bubble to tissue. The  $O_2$  window in this application is the  $P_{bubN_2} - P_{tisN_2}$  gradient.

Eq. 14 defines the partial pressure of  $N_2$  in a bubble as

$$P_{bubN_2} = P_B - P_{tisO_2} - P_{tisCO_2} - PH_2O. \quad \text{Eq. 14}$$

In the example above at sea level, a gas phase introduced into the body, from a bolus of gas injected under the skin, a pneumothorax from alveolar rupture, mediastinal emphysema from rupture of the trachea, or even evolved gas from inert gas supersaturation will all be absorbed through time as a consequence of the  $O_2$  window. The magnitude of the  $O_2$  window is not constant for all tissues at all times but depends on particular moment-to-moment metabolic and blood flow conditions in the tissue surrounding a gas phase. It is smaller, for example, in muscle tissue at rest than in brain tissue, owing to the high metabolic demands of neural tissue. Under steady-state conditions  $P_{AN_2} = P_{tisN_2}$ , so a quantifiable  $PN_2$  gradient exists between  $P_{bubN_2}$  and  $P_{AN_2}$ . However, when a bubble is in a tissue compartment with a long half-time, such as the theoretical 360-min half-time compartment used here,  $P_{AN_2}$  can change abruptly when a subject is breathing 100%  $O_2$ , whereas the  $P_{tisN_2}$  decreases slowly in response. Under this non-steady-state condition, the exact  $O_2$  window is less certain and is approximated by the  $P_{bubN_2} - P_{tisN_2}$  gradient, as is done in the TBDM. Therefore, breathing 100%  $O_2$  or  $O_2$ -enriched gas reduces  $P_{tisN_2}$  through denitrogenation and increases  $P_{bubN_2}$  through the  $O_2$  window. In particular, this overall process limits bubble growth during EVA while astronauts are breathing 100%  $O_2$ , and accelerates bubble dissolution during repressurization and subsequent symptom treatment by maximizing the  $P_{bubN_2} - P_{tisN_2}$  gradient.

Other factors besides the  $O_2$  window modify  $P_{bubN_2}$ , especially when a bubble becomes very small. For example, the effects of surface tension and tissue elasticity increase  $P_{bub}$  above  $P_B$ . Also,  $P_{tisN_2}$  eventually equilibrates with  $P_{AN_2}$ , so that the  $P_{bubN_2} - P_{tisN_2}$  gradient constantly changes through time until the bubble is absorbed. Substituting steady-state tissue gas tension values above into Eq.14 results in a  $P_{bubN_2}$  of 628 mmHg.  $P_{tisN_2}$  was 570 mmHg, so an  $O_2$

window of 58 mmHg ( $P_{\text{bubN}_2} - P_{\text{AN}_2}$ ) in this example is the concentration gradient by which diffusion of  $\text{N}_2$  occurs from the gas volume to the lungs. A  $P_{\text{bubN}_2} - P_{\text{tisN}_2}$  gradient for only  $\text{N}_2$  was described in this simplified description but during this steady-state dissolution of the gas phase a small outward diffusive gradient also exists for  $\text{O}_2$  and  $\text{CO}_2$ . These gradients are related through the reciprocals of blood solubility  $\times$  diffusivity of each gas. The result is about a 3-mmHg gradient for  $\text{O}_2$  and a 1-mmHg gradient for  $\text{CO}_2$  for a bubble in venous blood (Hlastala & Berger 2001).

Table V provides details about how  $P_{\text{W}}$  and normalized  $P_{\text{W}}$  ( $P_{\text{Wnorm}}$ ) are computed in 6 cases, all examples about DCS treatment associated with the Multi-Mission Space Exploration Vehicle (MMSEV). The reasons for providing these details are to demonstrate the importance of  $P_{\text{W}}$  and  $P_{\text{Wnorm}}$  to resolve a gas phase and to demonstrate that  $P_{\text{W}}$  is part of the TBDM.

Cases 1 through 6 in Table V are summarized as follows:

1. Steady-state treatment at 8.6 psia (14,000 ft) on air (adapted to hypoxia through chronic increase in ventilation) where  $P_{\text{tisN}_2} = P_{\text{AN}_2}$ .
2. Steady-state treatment at 8.2 psia (15,500 ft) on 34%  $\text{O}_2$  where  $P_{\text{tisN}_2} = P_{\text{AN}_2}$ .
3. 2-hours with 95%  $\text{O}_2$  treatment at 8.2 psia (15,500 ft) where  $P_{\text{tisN}_2} \neq P_{\text{AN}_2}$ , and 3  $P_{\text{tisN}_2}$ s are used in place of  $P_{\text{AN}_2}$ .
4. 35%  $\text{O}_2$  treatment at 14.7 psia where  $P_{\text{tisN}_2} \neq P_{\text{AN}_2}$ , and 3  $P_{\text{tisN}_2}$ s are used in place of  $P_{\text{AN}_2}$ .
5. 95%  $\text{O}_2$  treatment at 14.7 psia until  $\text{BGI} = 1$  where  $P_{\text{tisN}_2} \neq P_{\text{AN}_2}$ , and 3  $P_{\text{tisN}_2}$ s are used in place of  $P_{\text{AN}_2}$ .
6. 95%  $\text{O}_2$  treatment at 22.9 psia until  $\text{BGI} = 1$  where  $P_{\text{tisN}_2} \neq P_{\text{AN}_2}$ , and 3  $P_{\text{tisN}_2}$ s are used in place of  $P_{\text{AN}_2}$ .

**Table V. Estimated  $\text{O}_2$  Windows Related to MMSEV DCS Treatment**

variable	case 1	case 2	case 3	case 4	case 5	case 6	notes
$P_{\text{B}}$ (mmHg) altitude (ft)	447 14,000	422 15,500	422 15,500	760 0	760 0	1184 --	ambient pressure
$F_{\text{I}\text{O}_2}$	0.21	0.34	0.95	0.35	0.95	0.95	inspired dry-gas fraction of $\text{O}_2$
$P_{\text{A}\text{O}_2}$ (mmHg)	42	81	316	203	637	1040	from alveolar gas equation, equilibrium condition
$P_{\text{A}\text{CO}_2}$ (mmHg)	35	40	40	40	40	40	
$P_{\text{A}\text{H}_2\text{O}}$	47	47	47	47	47	47	partial pressure of water vapor (BTSP)
$P_{\text{A}\text{N}_2}$	323	254	19	470	36	57	$P_{\text{A}\text{N}_2} = P_{\text{tisN}_2}$ , equilibrium condition, argon included as $\text{N}_2$
$\text{O}_{2\text{physoln}}$ (ml/dl)	0.13	0.25	0.98	0.63	2.0	3.2	vol% is ml (STPD)/dl, plasma content 0.0031 vol% / mmHg $P_{\text{A}\text{O}_2}$
$\text{C}_{\text{a}\text{O}_2\text{Hb}}$ (ml/dl)	16.2	19.2	20.0	19.9	20.0	20.0	blood content from blood-gas model <sup>1</sup>

$C_aO_2$ (ml/dl)	16.3	19.5	21.0	20.6	22.0	23.2	blood content from $O_{2\text{physoln}} + C_aO_{2\text{Hb}}$
$C_aCO_2$ (ml/dl)	46.0	47.6	47.4	47.4	47.4	47.4	blood content from blood-gas model
$C_vO_2$ (ml/dl)	11.3	14.5	15.9	15.6	70.0	18.2	blood content from blood-gas model
$C_vCO_2$ (ml/dl)	50.0	51.6	51.4	51.4	51.4	51.4	blood content from blood-gas model
$P_vO_2$ (mmHg)	28.0	37.6	43.5	41.7	49.0	49.0	blood partial pressure from blood-gas model, mixed $P_vO_2 \cong P_{\text{tis}}O_2$
$P_vCO_2$ (mmHg)	39.8	45.4	45.9	45.7	46.7	46.7	blood partial pressure from blood-gas model, mixed $P_vCO_2 \cong P_{\text{tis}}CO_2$
$P_{\text{tis}}N_2$ (mmHg)	323	254	19*	470*	36*	57*	equilibrium case where no $N_2$ is lost during EVA, $P_{\text{tis}}N_2 = P_{AN_2}$
$P_{\text{tis}}N_{2(1)}$ (mmHg)	294	225	200	350	200	200	first option where some $N_2$ is lost during EVA in cases 1 and 2 and is lost even more with $O_2$ treatment in cases 3, 5, and 6 but is added during pressure treatment at 14.7 psia in case 4, $P_{\text{tis}}N_2 \neq P_{AN_2}$ so $P_{\text{tis}}N_2$ in place of $P_{AN_2}$
$P_{\text{tis}}N_{2(2)}$ (mmHg)	269	200	175	300	175	175	second option where some $N_2$ is lost during EVA in cases 1 and 2 and is lost even more with $O_2$ treatment in cases 3, 5, and 6 but is added during pressure treatment at 14.7 psia in case 4, $P_{\text{tis}}N_2 \neq P_{AN_2}$ so $P_{\text{tis}}N_2$ in place of $P_{AN_2}$
$P_{\text{tis}}N_{2(3)}$ (mmHg)	244	175	150	250	150	150	third option where some $N_2$ is lost during EVA in cases 1 and 2 and is lost even more with $O_2$ treatment in cases 3, 5, and 6 but is added during pressure treatment at 14.7 psia in case 4, $P_{\text{tis}}N_2 \neq P_{AN_2}$ so $P_{\text{tis}}N_2$ in place of $P_{AN_2}$
$P_{\text{bub}}N_2$ (mmHg)	332	292	286	625	617	1041	equilibrium case, $P_{\text{bub}}N_2 = P_B - P_{\text{tis}}O_2 - P_{\text{tis}}CO_2 - P_{H_2O}$
$P_w$ (mmHg)	9	38	267*	155*	587*	984*	equilibrium case, $P_w = P_AO_2 + P_ACO_2 - P_{\text{tis}}O_2 - P_{\text{tis}}CO_2$ , or $P_w = P_{\text{bub}}N_2 - P_{AN_2}$ , or $P_w = P_B - (P_{\text{tis}}N_2 + P_{\text{tis}}O_2 + P_{\text{tis}}CO_2 + P_{H_2O})$
$P_{w(1)}$ (mmHg)	38	67	85	275	417	841	first option
$P_{w(2)}$ (mmHg)	63	92	110	325	442	866	second option

$P_{W(3)}$ (mmHg)	88	117	135	375	467	891	third option
$P_{Wnorm}$	0.03	0.13	0.93*	0.25*	0.95*	0.94*	equilibrium case, $P_{Wnorm} = P_w / P_{bubN_2}$ , or $P_{Wnorm} = (P_{bubN_2} - P_{AN_2}) / P_{bubN_2}$
$P_{Wnorm(1)}$	0.11	0.23	0.29	0.44	0.68	0.80	first option where $P_{tisN_2} \neq P_{AN_2}$ so $P_{tisN_2}$ in place of $P_{AN_2}$
$P_{Wnorm(2)}$	0.19	0.36	0.38	0.52	0.71	0.83	second option where $P_{tisN_2} \neq P_{AN_2}$ so $P_{tisN_2}$ in place of $P_{AN_2}$
$P_{Wnorm(3)}$	0.26	0.46	0.47	0.60	0.75	0.85	third option where $P_{tisN_2} \neq P_{AN_2}$ so $P_{tisN_2}$ in place of $P_{AN_2}$
$BGI$ resolution!!	> 800#	411	307	167	149	103	

Respiratory Exchange Ratio = 0.85 else 1.0 when 100% O<sub>2</sub> is breathed, tissue with arteriovenous O<sub>2</sub> difference of 5 vol% (O<sub>2</sub> extraction), Q<sub>s</sub>/Q<sub>t</sub> = 2%, Q<sub>t</sub> = 5 l/min, VO<sub>2</sub> = 250 ml/min, V<sub>A</sub>/Q = 1, Hb = 15 g/dl, and HbP<sub>50</sub> = 26 mmHg.

! Olszowka & Farhi 1968.

!! time (min) from start of treatment pressure (after repressurization from 4.3 psia) with BGI = 28 to reach BGI = 1 after 2-h of 95% O<sub>2</sub> treatment in the suit in case 3 and until BGI = 1 in cases 5 and 6.

\*these cases are not reasonable because  $P_{tisN_2} \neq P_{AN_2}$  since an O<sub>2</sub> (case 3) or pressure (case 4) or both (cases 5,6) treatment is under way.

# BGI reduced to 13.2 after 828 min but regrew while at 8.6 psia conditions.

Besides including computed  $P_w$  under 4 conditions ( $P_w$ ,  $P_{W(1)}$ ,  $P_{W(2)}$ , and  $P_{W(3)}$  for the 4 conditions of  $P_{tisN_2}$ : equilibrium  $P_{tisN_2}$ , and non-equilibrium cases,  $P_{tisN_2(1)}$ ,  $P_{tisN_2(2)}$ , and  $P_{tisN_2(3)}$ ), it is also important to include the 4 computed normalized O<sub>2</sub> windows,  $P_{Wnorm}$ :  $P_{Wnorm}$ ,  $P_{Wnorm(1)}$ ,  $P_{Wnorm(2)}$ , and  $P_{Wnorm(3)}$ . The normalized O<sub>2</sub> window is defined in Eq. 15:

$$P_{Wnorm} = P_w / P_{bubN_2} = (P_{bubN_2} - P_{AN_2}) / P_{bubN_2}. \quad \text{Eq. 15}$$

When a person breathes air, the normalized O<sub>2</sub> window is comparatively low, indicating that change of bubble size due to the O<sub>2</sub> window in air-breathing persons at altitude would be slower than in air-breathing persons at normal or hyperbaric pressures. This difference is because partial pressures of O<sub>2</sub> for both arterial and venous blood are on the steep part of the O<sub>2</sub>-Hb dissociation curve, so there is a small pO<sub>2</sub> difference between the two. But when a person breathes 100% O<sub>2</sub> long enough that  $P_{AN_2}$  and  $P_{tisN_2}$  are zero, the normalized O<sub>2</sub> window equals 1.0 for a bubble that contains N<sub>2</sub>. This condition sets the maximum rate for absorption of a bubble. When the arteriovenous difference is small, the O<sub>2</sub> window is as much as 50 times greater when a person breathes 100% O<sub>2</sub> than when they are breathing air.

The left column in Table V shows the environmental conditions for the 6 treatment simulations with the associated alveolar gas partial pressures; the O<sub>2</sub> and CO<sub>2</sub> content and resulting O<sub>2</sub> and CO<sub>2</sub> tensions in the arterial and venous blood and several N<sub>2</sub> tensions in the tissue ( $P_{tisN_2}$ ); and N<sub>2</sub> tension either in equilibrium with  $P_{AN_2}$  or not in equilibrium and estimated. The  $P_{tisN_2}$  for cases 3 through 6 are shown as if they are in equilibrium with  $P_{AN_2}$ , but in reality this could not be true. Cases 3 through 6 include treatment options where O<sub>2</sub>-enriched breathing gas or the application of pressure or both are part of the simulation and therefore  $P_{AN_2} \neq P_{tisN_2}$ . To advance the discussion about the O<sub>2</sub> window and bubble reabsorption to include realistic

scenarios, one must focus on the  $P_{N_2}$  gradient from  $P_{bubN_2}$  to  $P_{tisN_2}$  since  $P_{tisN_2}$  will not instantaneously reflect changes in  $P_{AN_2}$  during treatment interventions.  $P_{tisN_{2(1)}}$ ,  $P_{tisN_{2(2)}}$ , and  $P_{tisN_{2(3)}}$  are reasonable deviations from equilibrium tissue  $N_2$  tension due to conditions expected to change  $P_{tisN_2}$  and therefore change the  $P_{bubN_2} - P_{tisN_2}$  gradient. Note that, over a range of  $F_{I O_2}$  from 0.21 to 0.95 under various environmental conditions,  $P_{V O_2}$  and  $P_{V CO_2}$  remain low and relatively constant, contributing to a high  $P_{bubN_2}$ .

The lower part of Table V shows the results, the computed  $P_{bubN_2}$  based on Eq. 14,  $P_w$  based on Eq. 13,  $P_{Wnorm}$  based on Eq. 15, and finally the resolution time for a BGI of 28 units in the TBDM given some of the information from Table V. As expected, the fastest resolution time for the simulated bubble was with case 6;  $P_w$  was 984 mmHg with  $P_{Wnorm}$  at 0.94 compared to  $P_w$  of 58 mmHg with  $P_{Wnorm}$  of 0.09 to resolve a bolus of gas at 1 ATA introduced into tissue in a person breathing air. However, these values are for the unrealistic case where  $P_{AN_2} = P_{tisN_2}$  since treatment protocols are being simulated and  $P_{tisN_2}$  would not instantaneously equal  $P_{AN_2}$  under pressure and  $O_2$  treatment interventions. A better evaluation of  $P_w$  and  $P_{Wnorm}$  for the 6 cases is to consider a range of potential  $P_{tisN_2}$  for each case. The best statistical association between  $P_{Wnorm}$  and BGI resolution time when  $P_{tisN_2} \neq P_{AN_2}$  was obtained when the  $P_{tisN_{2(1)}}$  estimates were used.

Fig. 25 shows the relationship between BGI resolution time from 28.2 to 1.0 and  $P_{Wnorm(1)}$  where  $P_{tisN_{2(1)}}$  was used in place of  $P_{AN_2}$ . A relationship exists between an independent assessment of  $P_{Wnorm(1)}$ , where  $P_{Wnorm(1)} = (P_{bubN_2} - P_{tisN_{2(1)}}) / P_{bubN_2}$ , and an independent assessment of BGI resolution time. The relationship appears nonlinear, as expected since  $N_2$  kinetics in the bubble-tissue system is described with an exponential, and surface tension in a spherical bubble dramatically increases  $P_{bubN_2}$  as radius approaches zero. The conclusion is that the  $O_2$  window and other variables that define the  $P_{bubN_2} - P_{tisN_2}$  gradient are accounted for in the TBDM, although not with the amount of detail described by Van Liew *et al.* (1993, 1995). A summed mixed venous blood gas tension of 132 mmHg for  $O_2$ ,  $CO_2$ , and  $H_2O$  and an instantaneous equilibration of metabolic gases ( $P_{met}$ ) between tissue and bubble are simplifications used in the TBDM, and are sufficiently precise for our narrow application.

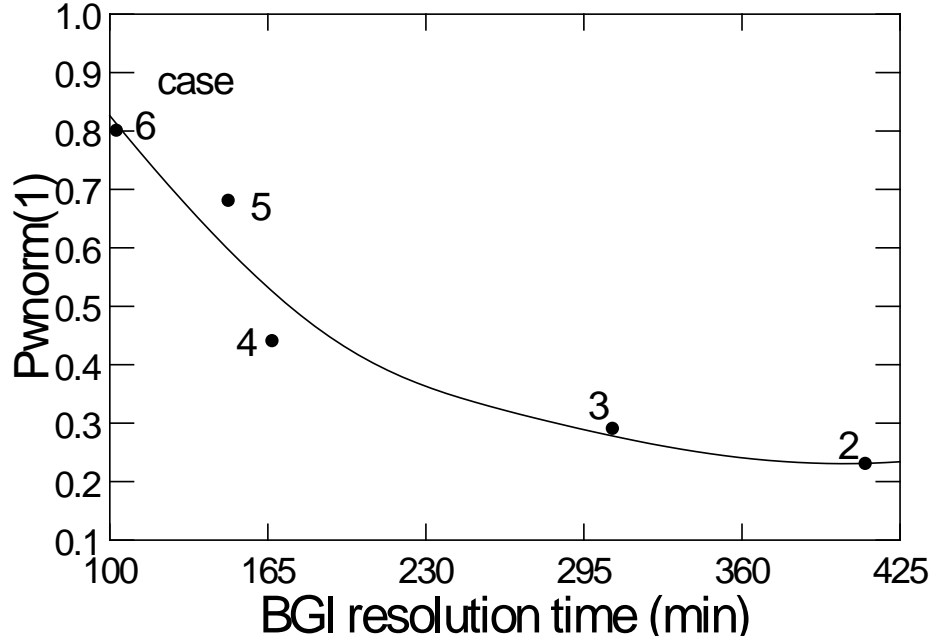

Fig. 25. Relationship between  $P_{Wnorm(1)}$  and BGI dissolution time. The greatest potential and rate of BGI reabsorption occur during a simulation of treatment case 6, breathing 95%  $O_2$  at 22.9 psia.

### Tissue Bubble Dynamics Model Details

Whether a bubble grows or dissolves depends on the sum of the flux of all gases in the bubble, each of which diffuses independently. The TBDM (Gernhardt 1991) is a biophysical model of bubble growth and resolution in tissue as defined by Eq. 16:

$$\frac{dr}{dt} = \frac{-\frac{\alpha D}{h} \left( P_B - vt + \frac{2\gamma}{r} + \frac{4}{3} \pi r^3 M - P_t - P_{met} \right) + \frac{rv}{3}}{P_B - vt + \frac{4\gamma}{3r} + \frac{8}{3} \pi r^3 M}, \quad \text{Eq. 16}$$

where  $r$  is the bubble radius (cm),  $t$  is time (sec),  $\alpha$  is Ostwald  $N_2$  solubility ( $0.0125 \text{ cm}^3_{\text{gas}} / \text{cm}^3_{\text{tissue}}$  for water at  $37^\circ\text{C}$ ),  $D$  is the diffusion coefficient ( $2.0 \times 10^{-8} \text{ cm}^2 / \text{sec}$  for water),  $h$  is bubble film thickness ( $3.0 \times 10^{-4} \text{ cm}$ ),  $P_B$  is initial ambient pressure ( $\text{dyne}/\text{cm}^2$ ),  $v$  is ascent or descent rate ( $\text{dyne}/\text{cm}^2 \times t$ ),  $\gamma$  is surface tension ( $30 \text{ dyne}/\text{cm}$ ),  $M$  is tissue modulus of elasticity, the ratio of bulk modulus ( $H$ ) of  $2.5 \times 10^8 \text{ dyne}/\text{cm}^2$  to articular cartilage volume ( $H/\text{cm}^3_{\text{tissue}} = M$ ,  $\text{dyne}/\text{cm}^2 \times \text{cm}^3$ ) times bubble volume  $\frac{4}{3} \pi r^3$  to compute a deformation pressure ( $\text{dyne}/\text{cm}^2$ ),  $P_t$  is total tissue tension of all inert gases ( $\text{dyne}/\text{cm}^2$ ) in the general model but is specifically tissue  $N_2$  tension ( $P_{\text{tis}N_2}$ ) in this application, and  $P_{\text{met}}$  are metabolic gas ( $O_2 + CO_2 + H_2O$ ) tensions ( $1.76 \times 10^5 \text{ dyne}/\text{cm}^2$ , or 132 mmHg). Eq. 16 is a first-order non-linear differential equation; however, it has no closed-form solution and must be solved numerically with the aid of a computer.

## Denitrogenation

The TBDM accommodates multiple half-time compartments to reflect the varying rates at which different body tissues take up and eliminate inert gases during and after a dive. However, in this application we use the same 360-min half-time compartment for tissue N<sub>2</sub> uptake and elimination for all PB conditions that do not include exercise during PB. Aviators and astronauts are initially in an environment that is in equilibrium with atmospheric PN<sub>2</sub>, so any PB procedure first eliminates N<sub>2</sub> from well-perfused tissues. Denitrogenation protocols used or tested by NASA are conservative; this leaves only tissues that retain N<sub>2</sub> as possible sources of DCS symptoms, discounting embolic insult. Therefore, in our modeling of DCS risk, computed P<sub>tis</sub>N<sub>2</sub> is an essential component of decompression dose, whether manifested as a simple TR (Conkin *et al.* 1996a, Conkin *et al.* 1996b, Conkin 1998, Conkin *et al.* 1998) or as a BGI (Abercromby *et al.* 2014) calculated in the TBDM. TR is defined as the ratio of computed P<sub>tis</sub>N<sub>2</sub> to P<sub>B</sub> at the start of the altitude exposure. BGI based on Eq. 16 is the ratio of final bubble radius to an initial pre-formed micronuclei radius of 3 μm. The BGI for a decompression exposure is calculated over the duration of the exposure, with peak BGI being a measure of decompression dose.

Initial equilibrium tissue N<sub>2</sub> tension P<sub>tis</sub>N<sub>2</sub>(0) is taken as ambient PN<sub>2</sub>, 11.6 psia (1 psi = 6.8947 × 10<sup>4</sup> dyne/cm<sup>2</sup>) at 1 ATA. The 1% contribution of argon in normal air is treated as if it were N<sub>2</sub>. A PB protocol often takes place over a long interval of time during which a resting subject breathes 100% O<sub>2</sub> by mask. However, these protocols can also be complex, for example when the total PB time *T* is divided into *m* smaller intervals (0, *t*<sub>1</sub>), (*t*<sub>1</sub>, *t*<sub>2</sub>), . . . , (*t*<sub>*m*-1</sub>, *T*=*t*<sub>*m*</sub>), with varying amounts of exercise performed during some of the intervals to accelerate denitrogenation.

Eq. 17 describes the change in P<sub>tis</sub>N<sub>2</sub> when there is a change in ambient PN<sub>2</sub> from P<sub>*a,i-1*</sub> to a new level P<sub>*a,i*</sub> over the *i*-th time interval Δ*t*<sub>*i*</sub> = (*t*<sub>*i-1*</sub>, *t*<sub>*i*</sub>).

$$P_{\text{tis}N_2}(i) = P_{a,i-1} + (P_{a,i} - P_{a,i-1})(1 - e^{-k_i \Delta t_i}) + s_i \Delta t_i - \frac{s_i}{k_i} (1 - e^{-k_i \Delta t_i}),$$

Eq. 17

where P<sub>tis</sub>N<sub>2</sub>(*i*) is the new value of P<sub>tis</sub>N<sub>2</sub> and the average rate of change (*s*<sub>*i*</sub>) of PN<sub>2</sub> in the breathing gas mixture is ((P<sub>*a,i*</sub> - P<sub>*a,i-1*</sub>) / Δ*t*<sub>*i*</sub>). The rate constant *k*<sub>*i*</sub> varies with exercise and is expressed as a function of normalized O<sub>2</sub> consumption  $\dot{V}_{O_2i}$  expressed as ml O<sub>2</sub>(STPD)×kg<sup>-1</sup>×min<sup>-1</sup>:

$$k_i = \frac{e^{\lambda \dot{V}_{O_2i}}}{519.37},$$

Eq. 18

where λ is assumed equal to 0.03 on the basis of a previous analysis of exercise PB (Conkin *et al.* 2004). For example, in PBs that contain intervals of rest and exercise, the resting O<sub>2</sub> consumption is 3.5 ml O<sub>2</sub>×kg<sup>-1</sup>×min<sup>-1</sup>, and thus *k*<sub>*i*</sub> is 0.00213; when the O<sub>2</sub> consumption during a brief bout of exercise is 35 ml O<sub>2</sub>×kg<sup>-1</sup>×min<sup>-1</sup>, then *k*<sub>*i*</sub> is 0.00550. In PBs that contain no exercise, the total PB time *T* consists of only one interval (*m* = 1) and O<sub>2</sub> consumption is negligible. In this case, Eq. 18 is evaluated with  $\dot{V}_{O_2} = 0$  and yields *k* = 1/519.37 = 0.00192. This value corresponds to a 360-min half-time through the relation *t*<sub>1/2</sub> = ln(2)/*k*. Changes in PN<sub>2</sub> occur through a change in ambient pressure while breathing either any constant O<sub>2</sub> – N<sub>2</sub> mixture

or an O<sub>2</sub> – N<sub>2</sub> mixture that changes in time while at a constant pressure. In most of our applications, 100% O<sub>2</sub> is breathed by mask during the PB and depressurization, while at altitude, and during repressurization. In this case, ambient PN<sub>2</sub> abruptly decreases to zero ( $P_{ai} = s_i = 0$ , for  $i > 0$ ) in all phases of the PB, so Eq. 17 reduces to  $P_{tis}N_2(i) = P_{a0} - P_{a0}(1 - e^{-k_i\Delta t_i})$ .

Eq. 17 is used to calculate  $P_{tis}N_2$  and then a decompression dose as TR at the start of the altitude exposure and BGI at any time during or after the altitude exposure, for example during repressurization and during subsequent GLO as part of a DCS treatment protocol. Additional details about quantifying the time course of denitrogenation during PB protocols with exercise are found in (Conkin *et al.* 2004).

### Example Application of the TBDM for Treatment Scenarios

Fig. 26 demonstrates the range of BGI response to 6 treatment scenarios in the MMSEV. Decompression sickness occurs 480 min after initial depressurization in the astronaut. There is a 5-min delay to begin a 2-min repressurization to 8.2 psia. The delay allows BGI to increase to 28.2. If the symptom resolved during the repressurization to 8.2 psia, then breathing 35% O<sub>2</sub> in the MMSEV would require 411 min to resolve the BGI to 1 (curve not shown). But if the astronaut repressurizes to 8.2 psia and breathes 95% O<sub>2</sub> after a suit purge, then this procedure would require 275 min from the start of O<sub>2</sub> treatment in the MMSEV at 8.2 psia to resolve the BGI to 1 (solid baseline curve).

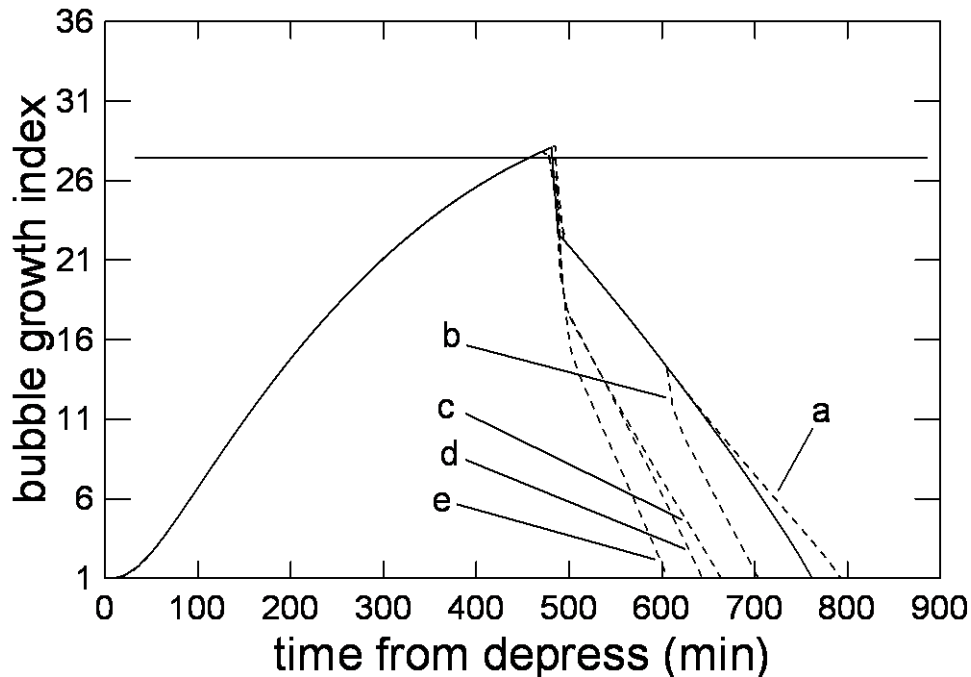

Fig. 26. Six simulated treatment cases in the MMSEV. DCS is reported in all 6 cases after BGI reaches 28.2 at 4.3 psia (horizontal line).



The 5 dashed curves in Fig. 26 are alternative options:

- a) return to suitport and treat with 95% O<sub>2</sub> for 2-h if the symptom cleared on repressurization (repress), then breathe 35% O<sub>2</sub> in MMSEV at 8.2 psia (307 min to resolve from BGI of 28.2 to 1 from return to 8.2 psia),
- b) return to suitport, treat with 95% O<sub>2</sub> for 2-h if the symptom cleared on repress, then repress to 14.7 psia and breathe 35% O<sub>2</sub> to accelerate bubble reabsorption (217 min to resolve from BGI of 28.2 to 1 from return to 8.2 psia),
- c) return to 14.7 psia and breathe 35% O<sub>2</sub> if the symptom did not clear on repress (167 min to resolve from BGI of 28.2 to 1 from return to 14.7 psia, comparable to an ISS case with 176 min to resolve a bubble in the suit at 19.0 psia with 95% O<sub>2</sub>),
- d) return to 14.7 psia and breathe 95% O<sub>2</sub> in suit for 2-h (unpressurized) if the symptom did not clear on repress (149 min to resolve from BGI of 28.2 to 1 from return to 14.7 psia), and
- e) return to 14.7 psia and breathe 95% O<sub>2</sub> in suit pressurized to 8.2 psia (total 22.9 psia) for an “emergency” Type II case (103 min to resolve from BGI of 28.2 to 1 from return to 22.9 psia).

## DCS Survival Model

A DCS survival model, based on symptom onset times and right-censored times, that relates the probability of DCS at a particular time  $[P(\text{DCS})_t]$  during the EVA is helpful when developing a treatment strategy, for additional perspective about the potential effectiveness of treatment. Our survival model expresses the probability  $P(T < t)$  of the DCS onset time  $T$  being less than a particular time  $t$  at altitude for environmental conditions associated with a simulated EVA. The BGI often increases through EVA time, and thus the likelihood of DCS increases since it takes time to grow a bubble sufficiently large to elicit a symptom. Therefore, it logically follows that lower  $P(\text{DCS})_t$  is associated with a smaller BGI and a smaller BGI is associated with lower symptom intensity. A low-probability case of DCS is still a case of DCS but fundamentally means those few with DCS have smaller BGI through time and lower symptom intensity. Conversely, a high-probability case of DCS is still a case of DCS but fundamentally means those many with DCS have larger BGI through time and higher symptom intensity. There is a linkage between group incidence and intensity of symptoms; the larger the group incidence (or probability), the greater the mean symptom intensity (Allen *et al.* 1971, Conkin *et al.* 1998). The above assertion is strengthened if a high-probability case that causes early onset (failure) of DCS is associated with a large BGI at the time of DCS and if a low-probability case that causes late onset of DCS is associated with small BGI or with a BGI as large as in the high-probability case but at a longer elapsed time. Our empirical data confirm the above assertion by showing that greater treatment pressure (during repressurization to site pressure) is needed for a high-probability case of DCS associated with larger BGI. Simple BGI, a single spherical bubble expanding or contracting in a unit volume of elastic tissue, as the only explanation for DCS incidence, type of symptom, onset time, symptom intensity, and symptom resolution would be

unrealistic in mechanistic terms. So the best to achieve is a pragmatic and utilitarian concordance between BGI and all aspects of DCS.

### **Log-logistic Accelerated Survival Model for DCS with BGI**

The general techniques of survival analysis and optimization through maximum likelihood are described elsewhere (Cox & Oakes 1984, Lee 1992). We have used the right-censored log-logistic survival model in other applications to estimate the  $P(\text{DCS})_t$  since the hazard function  $[h(t)]$  is non-monotone, meaning that instantaneous failure rate increases to a maximum and then decreases during the altitude exposure. This is the pattern for the rate of DCS observed through time (Conkin 1998, Conkin *et al.* 1996b). Estimation was made using the Survival Module in SYSTAT® version 13 software (Steinberg *et al.* 2009). The program minimizes the difference between the predicted outcome from the model and the observed dichotomous DCS outcome by making small, systematic adjustments to the parameters in the model. The optimization process continued until the absolute value of the summed log likelihood (LL) number was minimized.

Fig. 27 is the empirical representation of the CDF  $[F_n(t)]$  for 119 DCS cases out of 969 total exposures. The mean survival time was  $1.97 \pm 1.07$  h SD. The median survival time was 1.75 h and survival time ranged from 0.28 to 5.40 h. The range of time in 969 exposures was 2.0 to 24.0 h with a mean of  $5.4 \pm 4.2$  h SD.

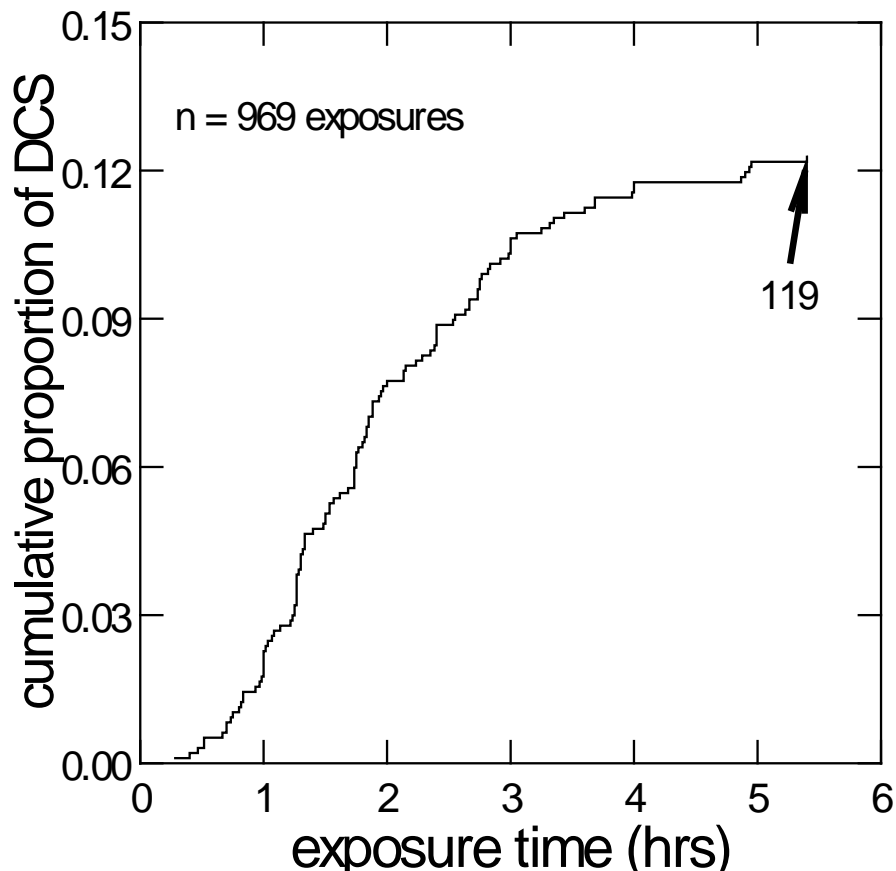

**Fig. 27. Cumulative proportion of DCS increased as exposure time increased in 47 protocols that totaled 969 altitude exposures.**

Eq. 19 is the CDF form of the log-logistic survival model used to describe the failure and right-censored times in the data used to create Fig. 27. Eq. 19 is expanded (accelerated) to include BGI for the planned exposure duration as the only explanatory variable.

$$F(t;z) = P(\text{DCS } T < t) = 1 / (1 + \exp(-(\ln(t) - 9.34 + 0.0560 \times \text{BGI}) / 0.914)), \quad \text{Eq. 19}$$

where  $F(t;z)$  is the CDF for the accelerated log-logistic survival model,  $P(\text{DCS } T < t)$  is the probability that survival time  $T$  for DCS is  $< t$ , that DCS will be observed in the interval between 0 and  $t$  ( $0 \leq T < t$ ),  $t$  is in mins from start of exposure at  $P_B$ , 9.347 is a fitted  $\beta_2$  coefficient, 0.0560 is a coefficient for BGI for the planned exposure duration, and 0.914 is the  $\beta_1$  coefficient in the log-logistic survival model.

The sample size for this regression was 968 exposures in 47 unique protocols with 119 total cases of DCS. For points of reference, we calculated the LL number for the constant-only model (null model) and, at the other extreme, the saturated (discontinuous) model, wherein the predicted values of  $P(\text{DCS})_t$  exactly match the observed DCS incidence in each of the 47 protocols. Our accelerated (continuous) model had an LL between the extremes of the null and discontinuous models. The null model LL of -556 compared to the continuous model LL of -518 and to the discontinuous model LL of -296 gauges the goodness of fit of the continuous model (Eq. 18). The difference in LL between the 2-parameter null model (-556) and the 3-parameter continuous model (-518) was significantly different at  $P < 0.01$  from the likelihood ratio test (Lee 1992), so an additional explanatory variable improved the regression.

Fig. 28 shows the increase in  $P(\text{DCS})_t$  during an EVA that extends to 6 h given the BGI at a particular time. The PB and EVA conditions dictate the change in BGI as defined by the TBDM, and Eq. 19 estimates the  $P(\text{DCS})_t$  at a particular time for the specific BGI at that time.

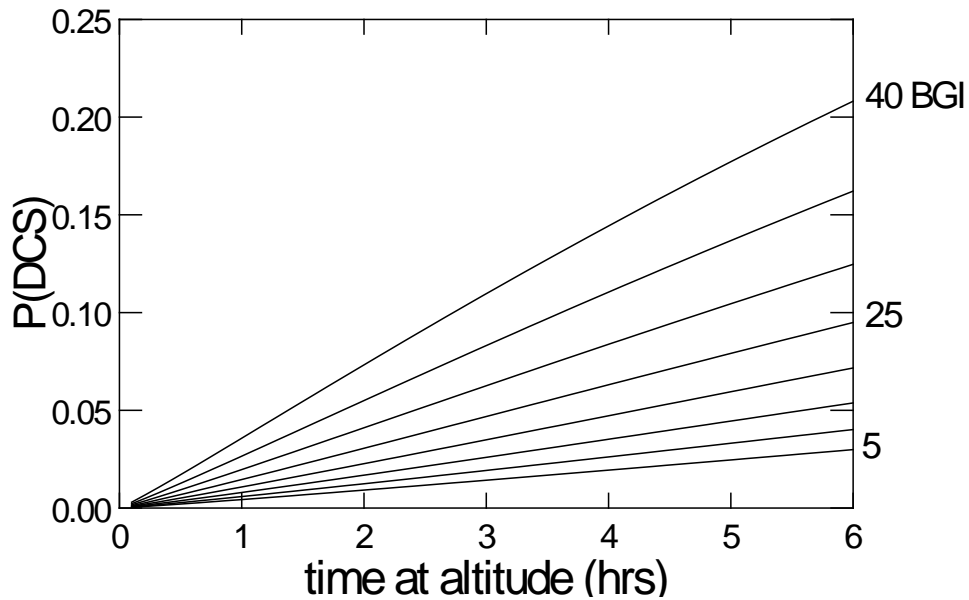

Fig. 28. Survival analysis results with BGI as only explanatory variable for DCS failure time.  $P(\text{DCS})_t$  as a function of time and maximum BGI in steps of 5 BGI units. A BGI of 40 at 60 min has a  $P(\text{DCS})_t$  of about 4%, but at 360-min the  $P(\text{DCS})_t$  is about 21%.

Fig. 29 shows the same model results as in Fig. 30 except that the x-axis is BGI.

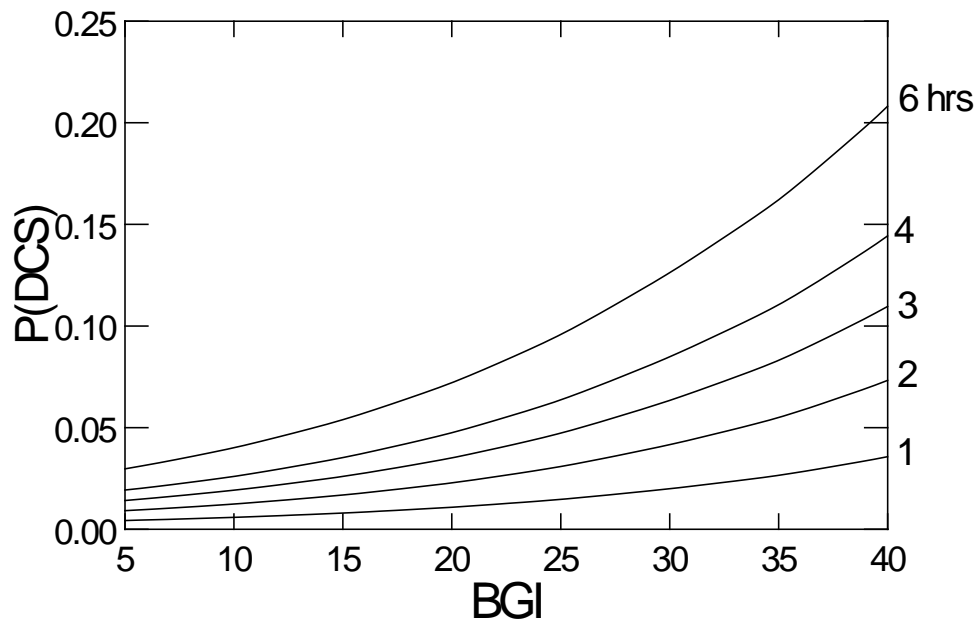

Fig. 29.  $P(\text{DCS})_t$  as a function of time and maximum BGI in steps of 5 BGI units. A BGI of 40 at 1.0 h has a  $P(\text{DCS})_t$  of about 4% but at 6.0 h the  $P(\text{DCS})_t$  is about 21%.

### Accelerated DCS Survival model

Variables other than BGI dictate the  $P(\text{DCS})_t$ . Eq. 20 includes explanatory variables in addition to BGI that statistically improved the survival model, and Table VI provides details about the regression.

$$F(t;z) = P(\text{DCS } T < t) = 1 / (1 + \exp(-(\ln(t) - 14.32 + 0.0132 \times \text{BGI} + 4.097 \times \text{TR} + 0.0241 \times \text{AGE} + 1.267 \times \text{AMB} - 0.0642 \times \text{BMI}) / 0.745)) \quad \text{Eq. 20}$$

where  $t$  is in mins from the start of exposure at  $P_B$ , 14.32 is a fitted  $\beta_2$  coefficient, 0.0132 is a coefficient for BGI for the planned exposure duration, 4.097 is a coefficient for TR at the start of altitude exposure, 0.0241 is a coefficient for AGE (in years), 1.267 is a coefficient for AMB, 0.0642 is a coefficient for BMI computed as mass in kg divided by height in  $\text{m}^2$ , and 0.745 is the  $\beta_1$  coefficient in the log-logistic survival model. When AMB is “1”, the subject ambulated before and during the altitude exposure and when AMB is “0” the subject did not ambulate.

The LL for the null model was again -556 compared to the LL of -476 for the continuous model (Eq. 20) and compared to the LL of -296 for the discontinuous model. The difference in LL between the 2-parameter null model (-556) and the 7-parameter continuous model (-476) was again significantly different at  $P < 0.01$  based on the likelihood ratio test.

**Table VI. Regression Details about DCS Survival Model**

parameter	estimate ± 95% CL	standard error	z-score	P-value
$\beta_1$	0.745 0.622 to 0.867	0.0626	11.89	<0.001
$\beta_2$	14.321 11.95 to 16.68	1.206	8.47	<0.001
TR	-4.097 -5.13 to -3.05	0.531	-7.71	<0.001
BGI	-0.0132 -0.027 to 0.000	0.00707	-1.87	0.0615
AGE	-0.0241 -0.042 to -0.005	0.00961	-2.50	0.0122
AMB	-1.267 -1.66 to -0.87	0.2007	-6.31	<0.001
BMI	0.0642 0.008 to 0.120	0.0285	2.24	0.0245

Table VII shows a comparison of the  $P(\text{DCS})_t$  computed from Eq. 20 to the observed incidence of DCS in 8 large-sample protocols. The regression results are based on 968 exposures during which 119 subjects reported DCS. Mean values for the required explanatory variables are included in the table. Overall, the predicted  $P(\text{DCS})_t$  is similar to the observed incidence, certainly if the upper and lower CLs are considered.

Table VII. Observed and Predicted DCS in Selected Large-Sample Protocols

Test	P <sub>B</sub> (psia)	time (min)	n	gender % male	mean age	mean TR	mean BGI	mean BMI	AMB	DCS (%)	P(DCS) <sub>t</sub> ± CL
3a	4.3	360	28	100	31.0	1.604	41.9	24.97	1	21.4	0.23 (0.18-0.29)
3b	4.3	360	35	100	30.1	1.675	45.2	24.87	1	22.8	0.31 (0.25-0.39)
8a	6.5	180	40	72.5	32.4	1.777	25.6	24.17	1	17.5	0.20 (0.15-0.27)
Phase I	4.3	240	49	71.4	29.4	1.869	41.7*	24.15	0	18.3	0.12 (0.09-0.16)
Phase II	4.3	240	50	76.0	32.2	1.854	40.8*	24.70	0	0	0.11 (0.08-0.15)
Phase IV	4.3	240	65	76.9	30.4	1.899	42.8*	24.70	0	12.3	0.14 (0.10-0.19)
Phase V-3	4.3	240	50	78.0	36.9	1.858	41.3*	25.14	0	14.0	0.13 (0.10-0.18)
Phase V-5	4.3	240	49	77.5	32.1	1.730	36.3*	24.56	0	4.1	0.06 (0.04-0.08)

3a. 4-h resting PB, 30-min ascent to 4.3 psia, ambulation plus EVA exercise during 6-h exposure.

3b. 1-h PB before ascent to 10.2 psia for 12 h breathing 26.5% O<sub>2</sub>, then 40-min PB before 25-min ascent to 4.3 psia for 6-h EVA exercise that included ambulation.

8a. No PB with 3.2-min ascent to 6.5 psia for 3-h EVA exercise that included ambulation.

\*PB included prescribed exercise; all others were resting during PB.

### Accelerated VGE Survival Model

An EVA is successful if there were no symptoms that compromised the goals of the EVA or compromised the health of the astronaut. It is not uncommon for a symptom-free decompression to still be associated with detectable VGE (Conkin *et al.* 1996b). A healthy lung is able to tolerate a small embolic load, but if possible the magnitude and frequency of pulmonary embolic insult should be minimized. To that end, a survival model for VGE onset is provided to assess the P(VGE) associated with EVA.

Fig. 30 is the empirical cumulative distribution [F<sub>n</sub>(t)] for 345 VGE cases out of 842 total exposures. The mean survival (failure) time was 1.47 ± 1.00 h SD. The range of time in 842 exposures was 2.0 to 6.0 h with mean of 4.0 ± 1.1 h SD.

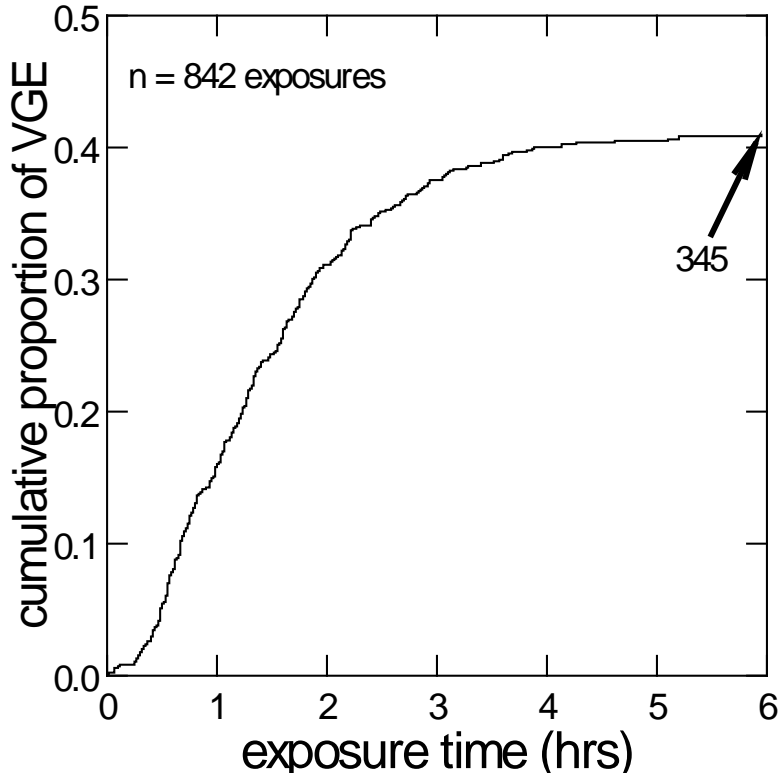

**Fig. 30. Cumulative proportion of VGE increased as exposure time increased in 40 protocols that totaled 842 altitude exposures.**

As with the DCS survival data, we also provide an analysis of the VGE survival data in Fig. 30. Those who develop PB procedures and plan operational EVA events can use Eq. 21 to estimate the probability that a particular EVA scenario will result in VGE. Table VIII provides details about the regression. Eq. 21 is the best-fit CDF form of the log-logistic accelerated survival model for interval-censored VGE.

$$F(t;z) = P(\text{VGE } T < t) = 1 / (1 + \exp(-(\ln(t) - 14.11 + 3.667 \times \text{TR} + 0.0349 \times \text{AGE} + 1.155 \times \text{AMB} + 0.548 \times \text{GENDER}) / 0.954)) \quad \text{Eq. 21}$$

where  $t$  is in mins from start of exposure at  $P_B$ , 14.11 is a fitted  $\beta_2$  coefficient, 3.667 is a coefficient for TR at the start of altitude exposure, 0.0349 is a coefficient for AGE (in years), 1.156 is a coefficient for AMB, 0.548 is a coefficient for GENDER, and 0.954 is the  $\beta_1$  coefficient in the log-logistic survival model. When AMB is “1”, the subject ambulated before and during the altitude exposure; when AMB is “0”, the subject did not ambulate. GENDER is “1” for male and “0” for female.

The sample size was 841 exposures in 40 unique protocols with 334 total cases of VGE. Differences between the null model LL of -1406 and the continuous model LL of -1336 and between the null model and the discontinuous model LL of -508 are used to gauge the goodness of fit of the continuous model (Eq. 21). The difference in LL between the 2-parameter null model (-1406) and the 6-parameter continuous model (-1336) was significantly different at  $P <$

0.01 based on the likelihood ratio test, so the additional explanatory variables improved the regression.

**Table VIII. Regression Details about VGE Survival Model**

<b>parameter</b>	<b>estimate ± 95% CL</b>	<b>standard error</b>	<b>z-score</b>	<b>P-value</b>
$\beta_1$	0.954 0.86 to 1.04	0.0454	20.991	<0.001
$\beta_2$	14.110 12.47 to 15.74	0.834	12.003	<0.001
TR	-3.667 -4.45 to -2.87	0.404	-9.080	<0.001
AMB	-1.155 -1.47 to -0.83	0.163	-7.089	<0.001
AGE	-0.0349 -0.051 to -0.018	0.00829	-4.209	<0.001
GENDER	-0.548 -0.897 to -0.198	0.178	-3.073	0.00211

Table IX shows a comparison of the  $P(VGE)_t$  computed from Eq. 21 to the observed incidence of VGE in 8 large-sample protocols. The regression results are based on 842 exposures where 345 subjects had VGE. Mean values for the required explanatory variables are included in the table. Overall, the predicted  $P(VGE)_t$  is similar to the observed incidence, certainly if the upper and lower CLs are considered.



**Table IX. Observed and Predicted VGE in Selected Large-Sample Protocols**

Test	P <sub>B</sub> (psia)	time (min)	n	gender % male	mean age	mean TR	mean BGI	mean BMI	AMB	VGE (%)	P(VGE) <sub>t</sub> ± CL
3a	4.3	360	28	100	31.0	1.604	41.9	24.97	1	46.4	0.61 (0.56-0.66)
3b	4.3	360	35	100	30.1	1.675	45.2	24.87	1	57.1	0.67 (0.62-0.72)
8a	6.5	180	40	72.5	32.4	1.777	25.6	24.17	1	50.0	0.57 (0.51-0.63)
Phase I	4.3	240	49	71.4	29.4	1.869	41.7*	24.15	0	49.0	0.41 (0.35-0.46)
Phase II	4.3	240	50	76.0	32.2	1.854	40.8*	24.70	0	30.0	0.42 (0.37-0.48)
Phase IV	4.3	240	65	76.9	30.4	1.899	42.8*	24.70	0	40.0	0.45 (0.40-0.51)
Phase V-3	4.3	240	50	78.0	36.9	1.858	41.3*	25.14	0	50.0	0.47 (0.42-0.53)
Phase V-5	4.3	240	49	77.5	32.1	1.730	36.3*	24.56	0	29.1	0.31 (0.27-0.36)

3a. 4-h resting PB, 30-min ascent to 4.3 psia, ambulation plus EVA exercise during 6-h exposure.

3b. 1-h PB before ascent to 10.2 psia for 12 h breathing 26.5% O<sub>2</sub>, then 40 min PB before 25-min ascent to 4.3 psia for 6-h EVA exercise that included ambulation.

8a. No PB with 3.2-min ascent to 6.5 psia for 3-h EVA exercise that included ambulation.

\*PB included prescribed exercise; all others were resting during PB.

Table X shows the P(DCS)<sub>t</sub> and P(VGE)<sub>t</sub> from the log-logistic survival models, both with 95% CL, as a function of EVA time given a simulation where TR was 1.22 (no PB) at the start of an EVA after the astronaut had lived in the MMSEV at 8.2 psia with 34% O<sub>2</sub> breathing atmosphere. The computed BGIs at 1, 2, 4, 6, and 8 h from the start of ascent to 4.3 psia were 3.3, 8.4, 17.5, 24.0, and 28.0 using the TBDM. The astronaut was a 35-year-old male with BMI of 25 who ambulated as part of a simulated surface EVA.

**Table X. P(DCS) and P(VGE) for MMSEV**

EVA Time (min)	P(DCS) <sub>t</sub>	95% CL	P(VGE) <sub>t</sub>	95% CL
60	0.002	0.001 – 0.005	0.061	0.042 – 0.088
120	0.006	0.003 – 0.011	0.118	0.084 – 0.164
240	0.016	0.009 – 0.028	0.216	0.159 – 0.287
360	0.029	0.017 – 0.052	0.300	0.224 – 0.380
480	0.045	0.026 – 0.080	0.364	0.280 – 0.456

The P(DCS)<sub>t</sub> was very low, even after an 8-h EVA. However, the upper 95% CL for the P(VGE)<sub>t</sub> was near 0.50 in this simulation. A mission planner might decide to divide the EVA task into 2 shorter EVAs of 4 h to reduce the P(VGE)<sub>t</sub>, or recommend that a reasonable interval of in-suit PB be performed before the start of a long EVA, just to minimize the risk of circulating VGE.

## Hypobaric DCS Treatment Model

The following analysis shows the final form of the Hypobaric DCS Treatment Model. Figs. 19 and 20 earlier in this report showed the regression results based only on observed  $\Delta P$  for the maximum available data: 158 symptoms that included 20 that definitively resolved during HBO treatment (Fig. 19) and 138 symptoms that excluded those 20 from the analysis (Fig. 20). The 95% CL for both regressions assumed independence among the symptoms, so the CL are different from what they would be if significant dependency among the symptoms were present.

Fig. 31 shows a comparison of the 95% CL with (solid) and without (dashed) dependency among the 158 symptom data, without regard to other explanatory variables. The difference is notable, but not dramatic.

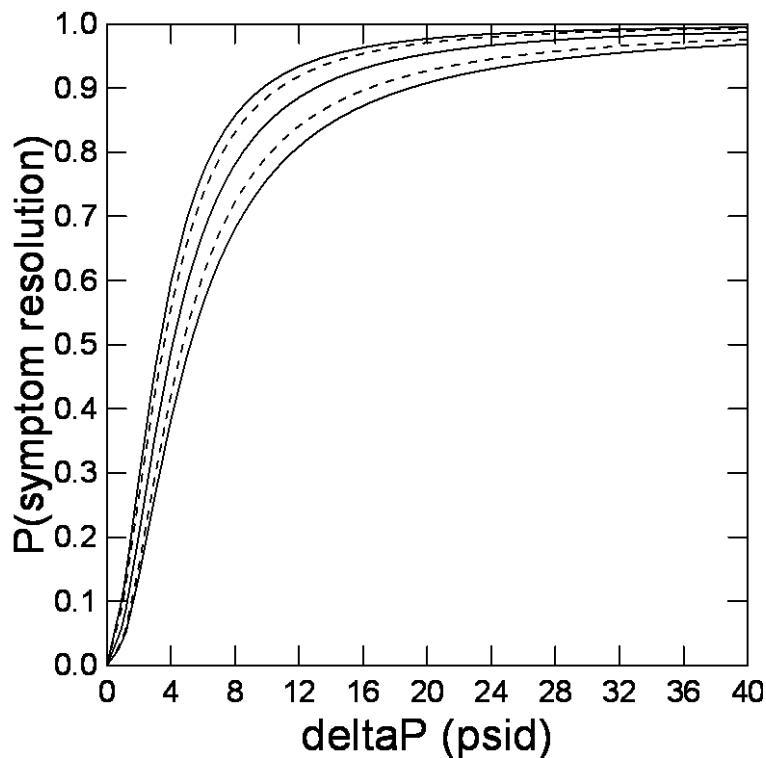

Fig. 31. Comparison of the  $P(\text{symptom resolution})$  based on 158 symptoms that resolved at a  $\Delta P$  between 0 and 37.1 psid.  $P(\text{symptom resolution}) = 1 / (1 + \exp(-(\ln(\Delta P) - 1.411) / 0.524))$ , plus 95% upper and lower CL as solid curves that account for dependency among symptoms and dashed curves that assume independence among symptoms.

Table XI shows regression results from SYSTAT<sup>®</sup> version 13 software (Steinberg *et al.* 2009) for the treatment model that includes  $\Delta P$ , elapsed time (min) at  $P_B$  to onset of symptom ( $T_s$ ), and ambulation state as explanatory variables, based on 154 symptoms where all explanatory variables were available and where dependency among symptoms is not considered. The 2-parameter null model returned an LL of -359 compared to the 4-parameter accelerated (continuous) model (Eq. 22) LL of -345. The difference in LL was significantly different at  $P < 0.01$  based on the likelihood ratio test. Maximum symptom intensity was a significant

explanatory variable in these data along with  $T_s$  and ambulation state. However, it was available for only 87 of the 154 symptoms and so was not considered further. Maximum symptom intensity was also significant in a model from the combined NASA and USAF data (see Table XVII), but was available for only 1,361 of the 1,707 symptoms.

**Table XI. Regression Details about Symptom Resolution Model (No Dependency)**

<b>parameter</b>	<b>estimate ± 95% CL</b>	<b>standard error</b>	<b>z-score</b>	<b>P-value</b>
$\beta_1$	0.478 0.54 to 0.41	0.0326	14.66	<0.001
$\beta_2$	1.510 1.24 to 2.12	0.172	8.74	<0.001
AMB	-0.795 -1.08 to -0.50	0.148	-5.35	<0.001
$T_s$ (min)	0.00308 0.0009 to 0.0052	0.0011	2.77	0.005

Table XII shows results from the same regression, but dependency among symptoms was considered using STATA<sup>®</sup> version 13 software (StataCorp 2013). We used information about 154 symptoms to fit the model. In particular, 56 men (mean age and BMI ± SD of 33.2 ± 8.2 and 24.2 ± 2.2) reported 119 symptoms and 18 women (mean age and BMI ± SD of 34.1 ± 8.0 and 22.0 ± 2.1) reported 35 symptoms. Note that the estimates for the 4 coefficients are identical, but the standard errors were slightly larger when dependency was considered. A larger standard error creates wider CL. Assessing goodness of fit of Eq. 22 was done through the Wald statistic in place of the likelihood ratio test because there was no assumption of independence among symptoms. The computed  $\chi^2$  was 13.99, and with 2 degrees of freedom the  $P$ -value was <0.001, so the 2 explanatory variables improved the regression.

**Table XII. Regression Details about Symptom Resolution Model (Dependency)**

<b>parameter</b>	<b>estimate ± 95% CL</b>	<b>standard error*</b>	<b>z-score</b>	<b>P-value</b>
$\beta_1$	0.478 0.41 to 1.79	0.077	9.48†	<0.001†
$\beta_2$	1.510 1.06 to 1.95	0.227	6.65	<0.001
AMB	-0.795 -1.28 to -0.304	0.250	-3.17	0.002
$T_s$ (min)	0.00308 0.0010 to 0.0052	0.00107	2.87	0.004

\*Adjusted for dependency among 154 symptoms.

† $\beta_1$  is constrained to be positive so its sampling distribution is skewed right, giving a standard error that is not entirely meaningful. It is better to use the standard error for  $\ln(\beta_1)$  to get confidence limits for  $\ln(\beta_1)$ , and then exponentiate to get confidence limits for  $\beta_1$ . For similar reasons, a z-score and  $P$ -value for  $H_0: \beta_1 = 0$  do not make sense, as by definition  $\beta_1 > 0$ . The values provided are based on  $\ln(\beta_1)$ .

The regression equation to estimate the P(symptom resolution) is

$$P(\text{symptom resolution}) = 1 / (1 + \exp(-(\ln(\Delta P) - 1.510 + 0.795 \times \text{AMB} - 0.00308 \times T_s) / 0.478)), \quad \text{Eq. 22}$$

where  $\Delta P$  is a real or computed input;  $\text{AMB} = 1$  if ambulation took place during part of the altitude exposure, otherwise  $\text{AMB} = 0$ ; and  $T_s$  is the elapsed time at  $P_B$  in min to the onset of a DCS symptom. Because one source of  $\Delta P$  input comes from the TBDM, we consider Eq. 22 to be a model even though Eq. 22 is simply a statistical regression equation optimized to empirical data.

Fig. 32 shows 4 curves from Eq. 22 for an ambulatory exposure where the subject reports a symptom at 60, 120, 180, or 240 min into the exposure. As the time to report a symptom increases, the P(symptom resolution) at a particular  $\Delta P$  decreases.

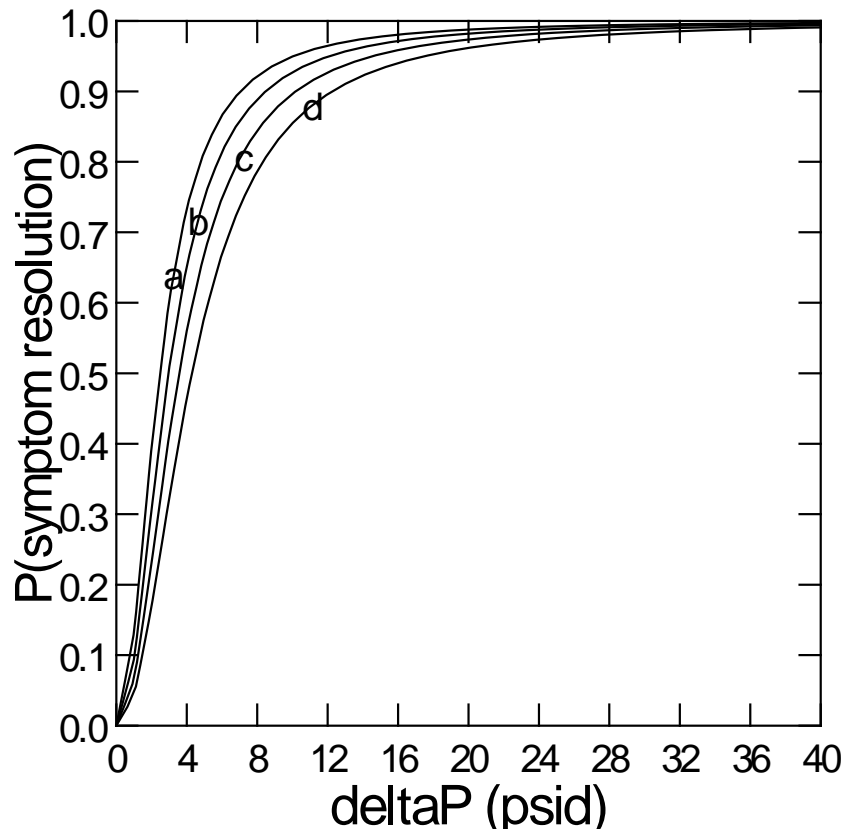

Fig. 32. P(symptom resolution) for the ambulatory condition. The subject reports a symptom at a) 60 min, b) 120 min, c) 180 min, or d) 240 min into the exposure.

Fig. 33 shows 4 curves from Eq. 22 for a nonambulatory exposure during which the subject reports a symptom at 60, 120, 180, or 240 min into the exposure. As the time to report a symptom increases, the P(symptom resolution) at a particular  $\Delta P$  decreases. Also, the

P(symptom resolution) is lower for the nonambulatory condition than it is for the ambulatory condition at a given symptom onset time at a particular  $\Delta P$ .

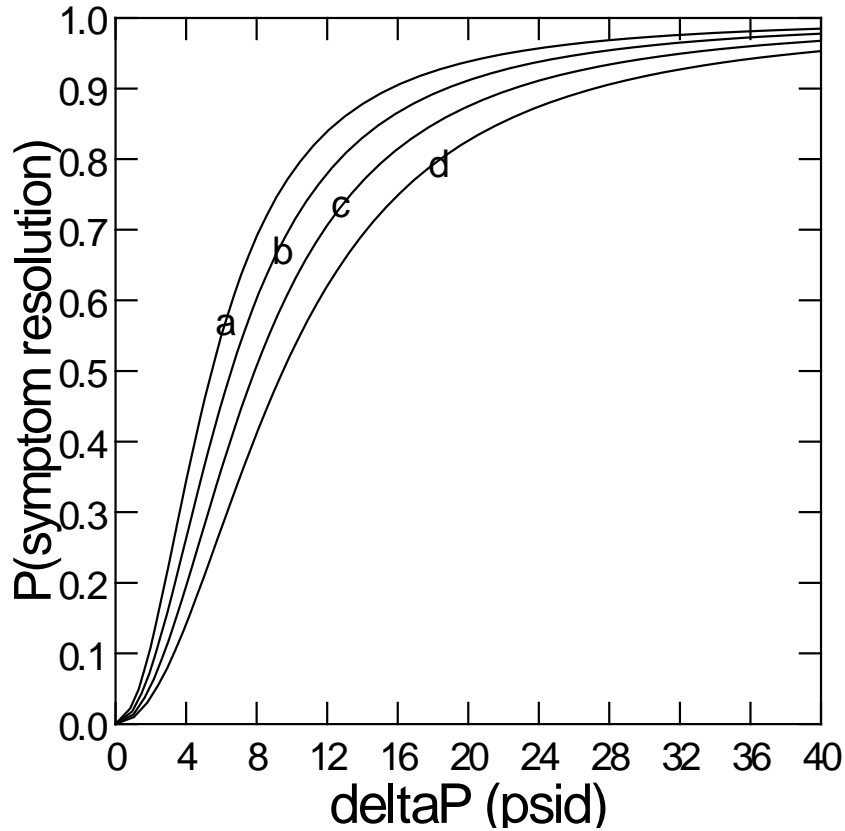

Fig. 33. P(symptom resolution) for the nonambulatory condition. The subject reports a symptom at a) 60 min, b) 120 min, c) 180 min, or d) 240 min into the exposure.

We have no mechanistic explanation why the P(symptom resolution) for a given  $\Delta P$  and  $T_s$  is so much lower for the nonambulatory condition than it is for the ambulatory condition. However, a comparison of data in Table XIII does suggest why the regression performs as it does.

Table XIII. Comparison of Ambulatory and Nonambulatory Symptom Data

data source	ambulatory (n=100 symptoms)	nonambulatory (n=54 symptoms)
	historical testing (1983-1998)	PRP testing (1999-2009) plus historical adynamia testing
DCS cases	78	41
global DCS%	13% (78 / 591 exposures)	11% (41 / 378 exposures)
mean symptom time	142 ± 68 min	116 ± 41 min
Type I symptoms	93% (93 / 100 symptoms)	83% (45 / 54 symptoms)
Type II symptoms	7% (7 / 100 symptoms)	17% (9 / 54 symptoms)
GLO after symptom	38% (38 / 100 symptoms)	89% (48 / 54 symptoms)
HBO after symptom	3% (3 / 100 symptoms)	31% (17 / 54 symptoms)

Prebreathe Reduction Program (PRP) in which exercise during PB was used to accelerate denitrogenation.

The global DCS incidence is about the same for the ambulatory (13%) and nonambulatory (11%) conditions, suggesting that the overall decompression stress is about equivalent for the 2 conditions. However, of the 20 symptoms that were persistent or residual at site pressure, thus requiring subsequent HBO treatment, 17 were reported by 7 subjects tested in the nonambulatory condition, whereas only 3 were reported by 2 subjects who were ambulatory. Considering that almost 2/3 of these symptoms (100/154) arose from testing of ambulatory subjects, it appears that symptoms arising from the nonambulatory condition would require greater  $\Delta P$  for resolution.

Fig. 34 shows the  $P(\text{symptom resolution})$  for  $T_s = 120$  min in the ambulatory (upper curve) and the nonambulatory (lower curve) condition. The 95% CL, not accounting for dependency among the symptoms, show a greater range for the nonambulatory condition.

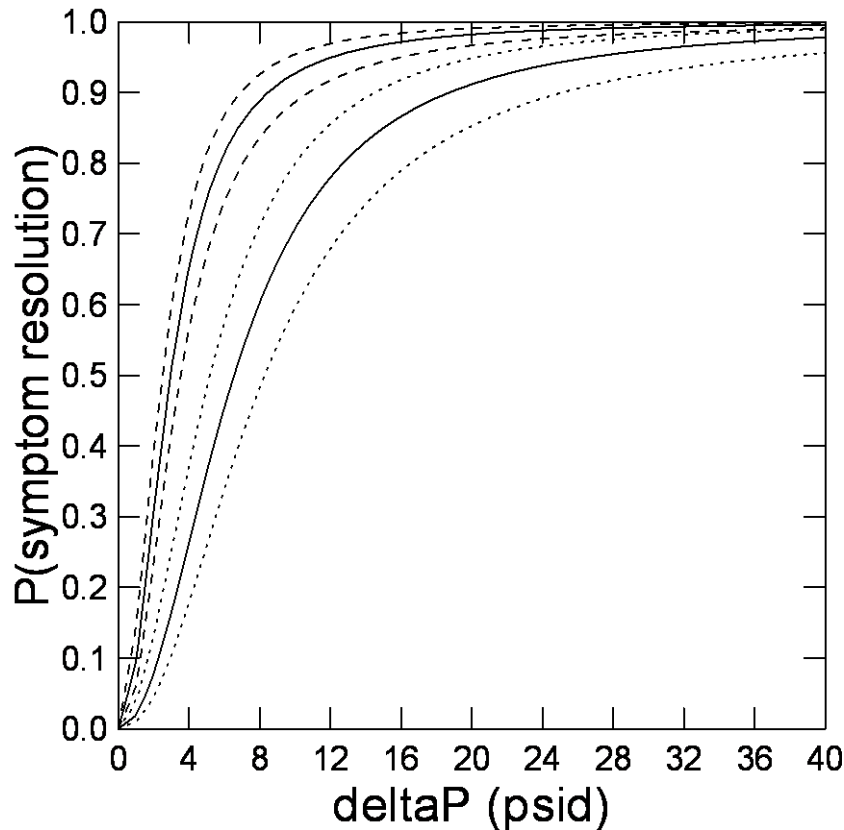

**Fig. 34. Simulation with ambulatory (upper curve) and nonambulatory (lower curve) subjects without accounting for dependency among symptoms, where  $T_s = 120$  min. The figure demonstrates the range of the 95% CL without accounting for dependency among symptoms.**

Finally, Fig. 35 shows the  $P(\text{symptom resolution})$  for  $T_s = 120$  min in the ambulatory (upper curve) and the nonambulatory (lower curve) condition. The 95% CL, accounting for dependency among the symptoms, show a greater range for the nonambulatory condition than for the ambulatory condition and larger range than in Fig. 34.

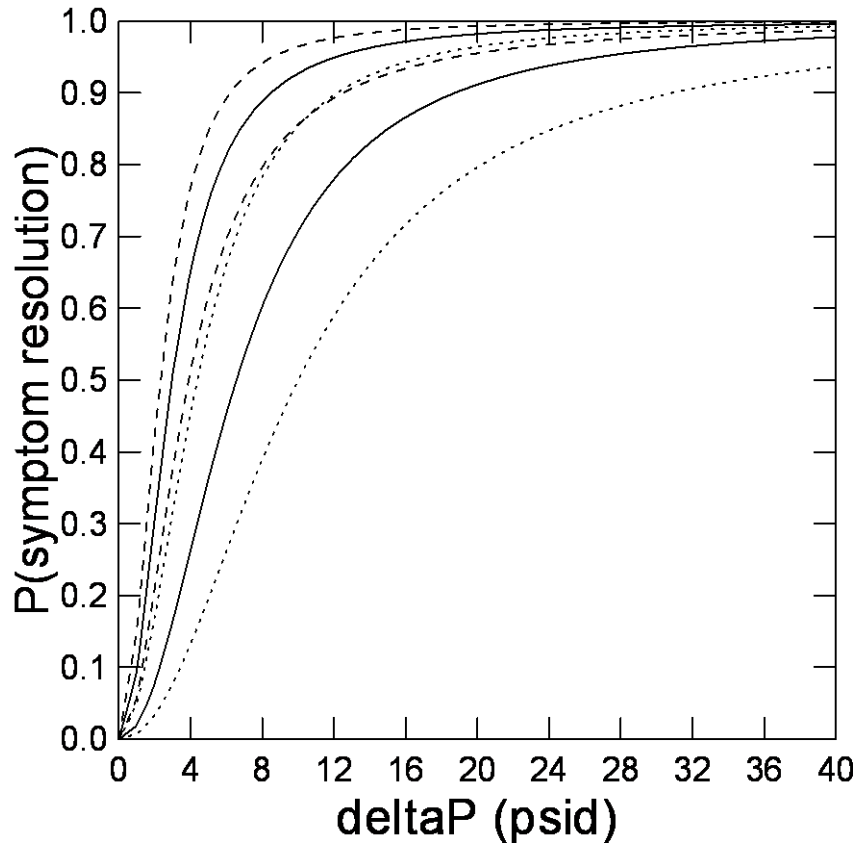

Fig. 35. Simulation with ambulatory (upper curve) and nonambulatory (lower curve) subjects accounting for dependency among symptoms, where  $T_s = 120$  min. The figure demonstrates the range of the 95% CL after accounting for dependency among symptoms.

### Simulations to Estimate P(symptom resolution)

Two simulations show the application of the treatment model (Eq. 22). Fig. 36 shows the time course of BGI growth and resolution calculated from Eq. 16 for a hypothetical treatment situation in which a 120-min resting PB at 14.7 psia and a 6-min ascent to 4.3 psia on 100%  $O_2$  have reduced and continue to reduce  $P_{tis}N_2$  (Eq. 17) through time. Pain occurs in an ankle at  $T_s = 60$  min after the beginning of the ambulatory exposure (66 min from the start of ascent) with  $BGI = 15.0$ . A 30-min delay before repressurization then causes the BGI to increase to  $B_1 = 21.8$ . Finally, the BGI reduces to  $B_{2a} = 14.8$  during a 15-min repressurization to 14.7 psia and continues to decrease to  $B_{2b} = 11.2$  during 60 min of GLO breathing at 14.7 psia.

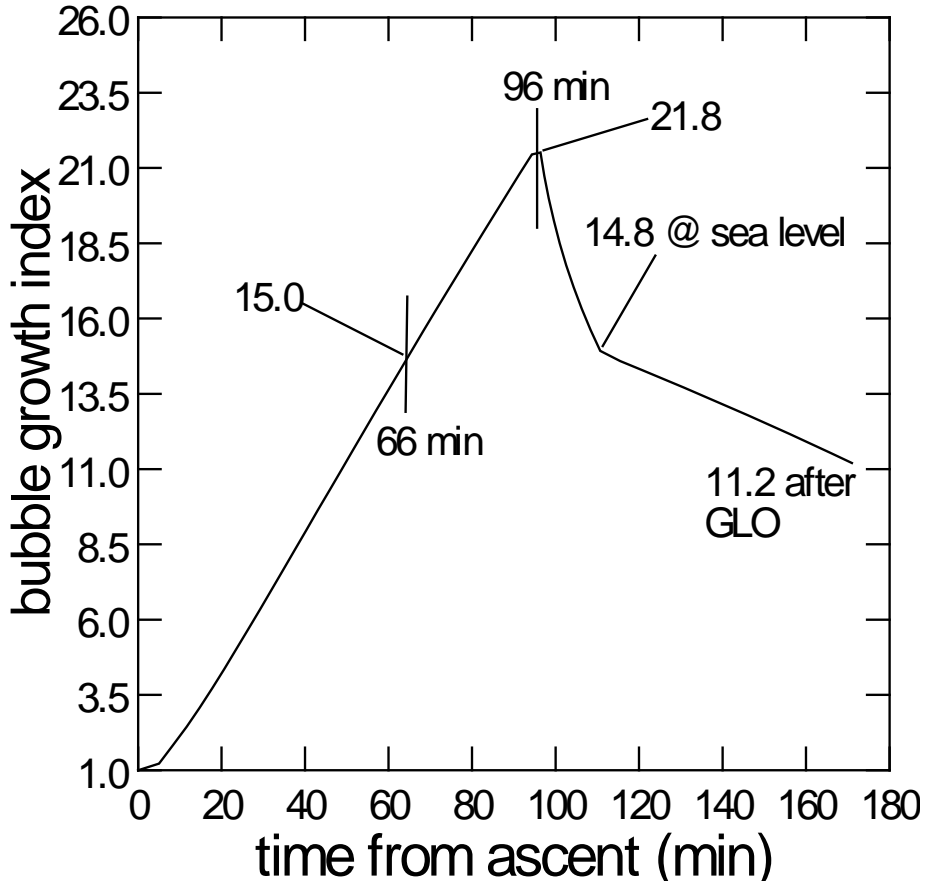

Fig. 36. Simulation of BGI growth at 4.3 psia and dissolution at 14.7 psia given a short PB with  $T_s = 60$  min and 66 min from start of ascent.

In this example, the values of  $\Delta P$  needed to reduce the BGI from  $B_1$  to  $B_{2a}$ , or from  $B_1$  to  $B_{2b}$  may be obtained from Eq. 9, where  $V_1$  is the volume of a spherical bubble with radius  $R_1 = 3 \times B_1 \mu\text{m}$  at the time just before repressurization interacting with a unit volume of tissue during the exposure at low pressure ( $P_1 = 4.3$  psia), and  $V_2$  is the new volume of a bubble with radius  $R_{2a} = 3 \times \text{BGI}_{2a} \mu\text{m}$  after a change to a higher pressure ( $P_2 = 14.7$  psia) at the end of the repressurization, or with radius  $R_{2b} = 3 \times B_{2b} \mu\text{m}$  at the end of the subsequent GLO breathing. Thus, before repressurization,  $V_1 = \frac{4}{3}\pi R_1^3 = 1,176,964.8 \mu\text{m}^3$ . Subsequently,  $V_2 = \frac{4}{3}\pi R_{2a}^3 = 370,255.0 \mu\text{m}^3$  at the end of repressurization or  $V_2 = \frac{4}{3}\pi R_{2b}^3 = 159,167.1 \mu\text{m}^3$  after the 60-min GLO treatment. Thus, using Eq. 9 with  $P_1 = 4.3$  psia, the value of  $\Delta P$  needed to reduce the BGI from  $B_1$  to  $B_{2a}$  (21.8 to 14.8) would be 9.37 psid and to reduce it from  $B_1$  all the way to  $B_{2b} = 11.2$ , with repressurization followed by a 60-min period of GLO, would require a higher  $\Delta P$  to 27.5 psid. Substituting these values of  $\Delta P$  into Eq. 22 with  $\text{AMB} = 1$  and  $T_s = 60$  min, we obtained  $P(\text{symptom resolution}) = 0.94$  (0.86 to 0.97) after the repressurization step to sea level and  $P(\text{symptom resolution}) = 0.99$  (0.98 to 0.998) at the conclusion of the GLO breathing, at an estimated total treatment time of 75 min. Ninety-five percent CL shown in parentheses reflect the sampling uncertainty of the fitted model.



A consideration about this result is the potential linkage between the  $P(\text{DCS})_t$  and the  $P(\text{symptom resolution})$ . An example of computing  $P(\text{DCS})_t$  builds on the example we developed with Fig. 36 to compute the 2  $P(\text{symptom resolution})$ s. The computed  $P(\text{DCS})_t$  is additional information to potentially supplement the interpretation of  $P(\text{symptom resolution})$  (see Discussion). The  $P(\text{DCS})_t$  is 0.32 (0.17 to 0.52), taken from Eq. 20 where time is 60 min from the start of the exposure at 4.3 psia to report the symptom, BGI is 21.8 at the start of repressurization, TR is 2.11 at the start of the exposure at 4.3 psia because 126 min of breathing 100%  $\text{O}_2$  has reduced the computed  $P_{\text{tisN}_2}$  (Eq. 17) to 9.10 psia, using  $0 \text{ ml} \times \text{kg}^{-1} \times \text{min}^{-1}$  for  $\text{O}_2$  consumption since the PB had no exercise, AGE is 45 years, BMI is 25, and ambulation status is 1. The person in this example reports a symptom of DCS even though the  $P(\text{DCS})_t$  at the time of the report is  $< 0.50$ , taking the upper 95% CL. The rather high estimate of 0.32 suggests that the symptom onset time might be shorter and the intensity of the symptom might be greater than if the estimate were closer to 0.05, especially since there is a 30-min delay to the start of repressurization. So the high  $P(\text{symptom resolution})$  of 0.94 on return to sea level likely resolves the symptom. But the subject would probably benefit from the additional 60 min of GLO before accepting that the symptom is adequately treated.

### Overall Risk Model for Future Missions

Dr. Feiveson had the insight to combine the models for  $P(\text{DCS})_t$  and  $P(\text{symptom resolution})$  to calculate a measure of risk incurred by having only enough capability to apply  $\Delta P$  up to a specified value of  $\Delta P$  for a future mission. From Eq. 20, let  $G(t; \mathbf{x}) = P(T < t)$  given a vector of predictors  $\mathbf{x}$ , consisting of observed values of BGI, TR, AMB, BMI, and AGE. Also let  $g(t; \mathbf{x}) = \partial G(t; \mathbf{x}) / \partial t$  be the corresponding probability density of time to DCS given  $\mathbf{x}$ . Note also that the model for  $P(\text{symptom resolution})$  is conditional on DCS having occurred at some time  $T_s$ . In terms of Eq. 22 with  $T_s = t$ , and  $y_i$  equal to some fixed treatment pressure differential  $\Delta p_0$ , one can re-express  $P(\text{symptom resolution})$  as  $F(\Delta p_0; t, \mathbf{x})$ , where  $\mathbf{x}$  is the same vector of predictors as used in the model for DCS time of occurrence. (Some of the components of  $\mathbf{x}$  might have zero coefficients in one of the 2 models.) Considering all possible values of  $t$ , these 2 models can then be combined to give the probability that a subject with observed predictors  $\mathbf{x}$  develops DCS that cannot be resolved with some fixed treatment pressure differential  $\Delta p_0$ .

$$Q(\mathbf{x}) = \int g(t; \mathbf{x}) [1 - F(\Delta p_0; t, \mathbf{x})] dt \quad \text{Eq. 23}$$

By taking into account likely values of  $\mathbf{x}$  that might occur during EVAs, NASA mission planners could use  $Q(\mathbf{x})$  as a measure of risk incurred by not carrying a capability for  $\Delta P$ s greater than  $\Delta p_0$ .

Building on the example illustrated with Fig. 36, we used the model for  $P(\text{symptom resolution})$  and the model for  $P(\text{DCS})_t$  to evaluate the corresponding risk of not having enough  $\Delta P$  capability on a future mission. More specifically, we used Eq. 23 to calculate the probability  $Q$  of having DCS occur and fail to respond to treatment, given a maximum  $\Delta P$  capability (max  $\Delta P$ ) on a future mission involving a 45-year-old astronaut with BMI = 25 undergoing ambulation during an EVA under conditions where TR = 2.11 at the start of exposure and the BGI = 21.8 at the start of repressurization (as detailed above). Fig. 37 shows the risk ( $Q$ ) as a function of max  $\Delta P$ . In particular, if such a future mission did not have an HBO capability and EVAs were conducted at

4.3 psia, then max  $\Delta P$  would be equal to 10.4 (14.7 – 4.3) psid. From Fig. 37, it can be seen that the incurred risk of a non-treatable DCS event in this case would be quantified by  $Q = 0.162$  (16.2%). The conclusion is that a capability for repressurization beyond 14.7 psi and the judicious use of 100% O<sub>2</sub> are considerations in the design of future exploration missions.

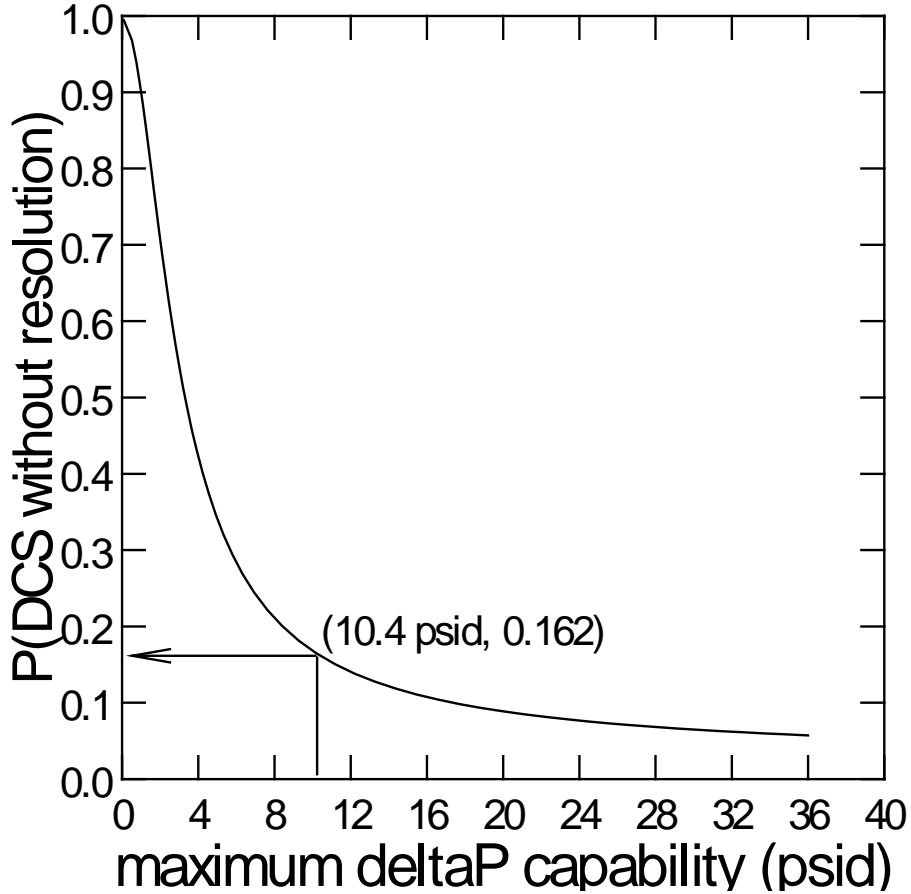

**Fig. 37.** Application of Eq. 23 given a future hypothetical EVA similar to the example shown and described by Fig. 36. There is a 0.16 probability that an astronaut will incur DCS and not have symptom resolution given the details of the exposure and immediate recompression to 14.7 psia from 4.3 psia, a  $\Delta P$  of 10.4 psid.

Finally, Fig. 38 shows 2 simulations about an EVA from the MMSEV: a) with a 15-min in-suit PB at 8.2 psia breathing 85% O<sub>2</sub> (dashed curve), and b) no PB at all (solid curve). In the first simulation with PB the computed TR is 1.19. A symptom of DCS occurs 220 min from start of ascent (203 min from start of EVA) with a BGI of 15.1. A 20-min delay to the start of repressurization allowed BGI to increase to 16.4. The astronaut returns to 8.2 psia with a BGI of 13.3. A 2-h period of GLO with 85% O<sub>2</sub> continues in the suit that reduces the BGI to 7.0.

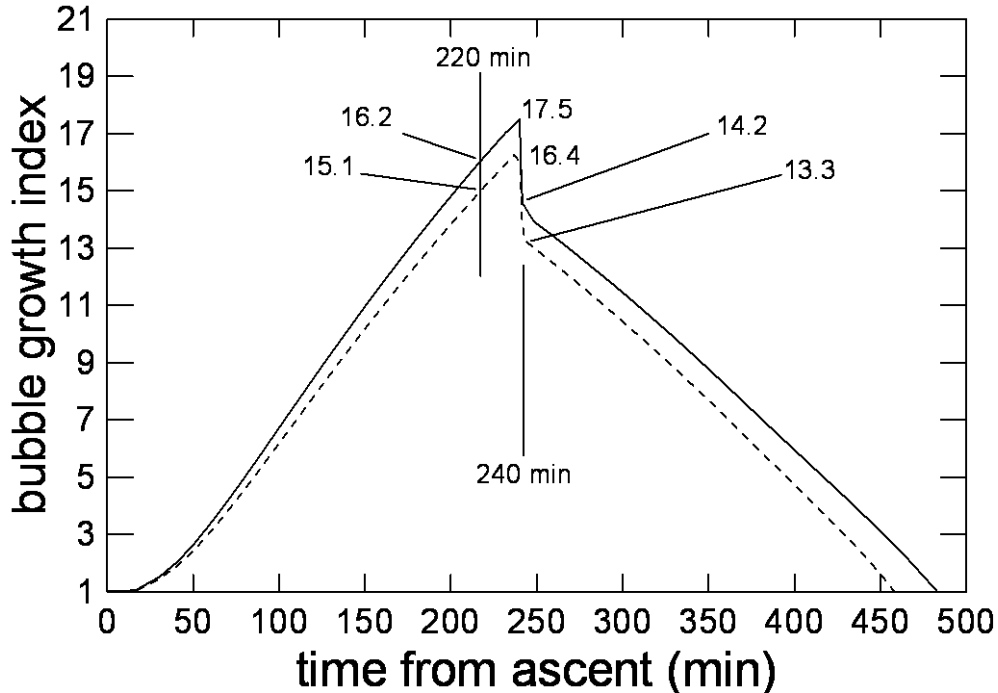

**Fig. 38. Realistic simulation scenario of an EVA from the MMSEV. The solid line is the BGI given no PB before a 17-min depressurization to 4.3 psia from 8.2 psia; the dashed line is after a 15-min PB with 85% O<sub>2</sub> before a 17-min depressurization. Repressurization is in 2-min, back to the MMSEV operating pressure of 8.2 psia. The BGI continues to slowly resolve in both cases as the astronaut breathes 85% O<sub>2</sub> in the suit for 2 h and then 34% O<sub>2</sub> in the habitat until BGI returns to 1.**

As before, BGI at the time of repressurization is converted to  $V_1$  and  $V_2$  after the repressurization back to 8.2 psia, and  $V_2$  after 2 h of GLO. The  $P(\text{symptom resolution})$  for the case of an ambulatory astronaut reporting a symptom 203 min into the EVA with a computed 3.76 psid is 0.49 (0.46 to 0.53) after the repressurization step to 8.2 psia. The  $P(\text{symptom resolution})$  is 1.0 for the case of a computed 51.0 psid at the conclusion of the GLO. In this example, the  $P(\text{DCS})_t$  is 0.015 (0.007 to 0.029), computed from Eq. 20. It is very unlikely that these conditions would result in a symptom. But if a symptom does occur, then it is reasonable to anticipate a mild symptom. A brief 20-min delay to repressurization ensures that the offending gas phase does not intensify the symptom. However, even the rapid 2-min return to 8.2 psia has a low  $P(\text{symptom resolution})$ , so additional time in the suit breathing 85% O<sub>2</sub> is warranted. The O<sub>2</sub> window and other factors that increase  $P_{\text{bub}}N_2$  maximize the dissolution of the offending gas phase such that the symptom is expected to resolve during the course of the GLO treatment.

In the second simulation without PB the computed TR is 1.22. As in the first simulation, a symptom with a BGI of 16.2 appears 220 min from the start of ascent. A 20-min delay to the start of repressurization allowed BGI to increase to 17.5. The astronaut returns to 8.2 psia, with a BGI of 14.2. The  $P(\text{symptom resolution})$  for the case of an ambulatory astronaut reporting a symptom 203 min into the EVA with a computed 3.75 psid is essentially the same as before [0.49 (0.36 to 0.62)] after the repressurization step to 8.2 psia. Instead of receiving GLO for 2 h in the suit at 8.2 psia, the astronaut is pressurized to 14.7 psia, and after a 6-min repressurization, the BGI is 11.4. The computed  $\Delta P$  for the decrease in BGI from 17.5 to 11.4 is 11.2 psid, with a  $P(\text{symptom resolution})$  of 0.90 (0.83 to 0.95). It is likely that the symptom will resolve during or

shortly after a pressurization to 14.7 psia, without GLO at 14.7 psia if O<sub>2</sub> resources are limited. But in this case, additional GLO at 14.7 psia seems warranted.

### Time to Resolve Gas Phase

Previous examples have shown the minimum treatment conditions needed to resolve a symptom. However, variability in response to the treatment conditions is expected, as reflected in the CL. There is a rationale to continue GLO past the point of symptom resolution, to minimize recurrent or late symptoms. In effect, prolonged GLO is treating an asymptomatic gas phase for the sake of completeness, given that 100% O<sub>2</sub> is readily available. But what guidance can the TBDM offer about the duration of time to provide GLO?

Fig. 39 demonstrates the benefit of a large initial Boyle's law compression combined with the accelerated reabsorption of the gas phase with 100% O<sub>2</sub> under 2 conditions where the astronaut returns to her saturation pressure, either 14.7 psia or 8.2 psia. The figure shows a comparison of BGI resolution time after returning to saturation pressure at 14.7 psia (curves at left) or 8.2 psia (curves at right), with (dashed curve) and without (solid curve) 2 h of 100% O<sub>2</sub> breathing once at saturation pressure. Breathing 100% O<sub>2</sub> shortens the resolution time by 109 min at 8.2 psia and by 57 min at 14.7 psia. The conclusions are specific to this 1 simulation given a spherical bubble with radius of 84 μm (a BGI of 28.0) since the size reduction due to the initial and important Boyle's law compression is a function of bubble volume which changes as r<sup>3</sup>. It would be incorrect to generalize these results to any other situation.

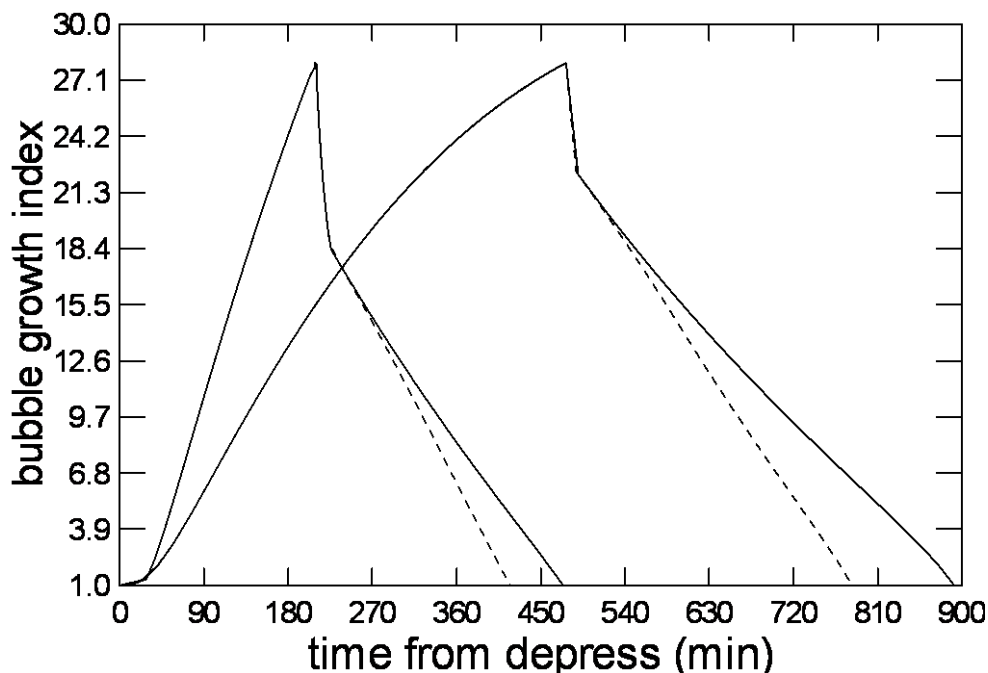

Fig. 39. Comparison of 2 repressurizations. The time to reduce BGI to 1 is greater for the 8.2 psia condition (curves at right) than for the 14.7 psia condition (curves at left), with (298 vs 192 min) or without (407 vs 249 min) 2 h of 100% O<sub>2</sub> treatment.

The 2 curves on the left show the increase in BGI to 28.0 after a 4-h PB and 30-min depressurization to 4.3 psia. The astronaut complains of a DCS symptom during the EVA and is

recompressed in 15 min to 14.7 psia, where BGI decreases initially to 18.4 at 225 min from the start of depressurization. If the astronaut breathes air at 14.7 psia, then the time to resolve BGI to 1 is 249 min, but if he first breathes 100% O<sub>2</sub> for 2 h as DCS treatment, then the time to resolve BGI to 1 is 192 min. Details about the 2 left curves: a) *left solid curve*, 14.7 psia air saturation, PB 4 h with 95% O<sub>2</sub>, depressurize to 4.3 psia in 30 min, EVA until BGI = 28.0 with 95% O<sub>2</sub>, repressurize to 14.7 psia in 15 min, and hold while breathing air until BGI = 1, b) *left dashed curve*, 14.7 psia air saturation, PB 4 h with 95% O<sub>2</sub>, depressurize to 4.3 psia in 30 min, EVA until BGI = 28.0 with 95% O<sub>2</sub>, repressurize to 14.7 psia in 15 min, hold at 14.7 psia while breathing 100% O<sub>2</sub> for 2 h, and hold while breathing air until BGI = 1.

The 2 curves on the right show the increase in BGI to 28.0 after a 17-min depressurization to 4.3 psia once saturated with N<sub>2</sub> at 8.2 psia while breathing 34% O<sub>2</sub>. The astronaut complains of a DCS symptom much later into the EVA and is recompressed in 5 min to 8.2 psia, where BGI decreases initially to 22.5 at 485 min from start of depressurization. If the astronaut breathes 34% O<sub>2</sub> at 8.2 psia, then the time to resolve BGI to 1 is 407 min, but if he first breathes 100% O<sub>2</sub> for 2 h as DCS treatment, then the time to resolve BGI to 1 is 298 min. Details about the 2 right curves: a) *right solid curve*, 8.2 psia and 34% O<sub>2</sub> saturation, purge to 85% O<sub>2</sub>, depressurize to 6.0 psia in 1 min, hold at 6.0 psia for 15 min, depressurize to 4.3 psia in 1 min, EVA until the balance of 8 h is complete with 85% O<sub>2</sub> – BGI grew to 28.0, repressurize to 8.2 psia in 5 min, and hold while breathing 34% O<sub>2</sub> until BGI = 1, b) *right dashed curve*, 8.2 psia and 34% O<sub>2</sub> saturation, purge to 85% O<sub>2</sub>, depressurize to 6.0 psia in 1 min, hold at 6.0 psia for 15 min, depressurize to 4.3 psia in 1 min, EVA until the balance of 8 h is complete with 85% O<sub>2</sub> – BGI grew to 28.0, repressurize to 8.2 psia in 5 min, hold at 8.2 psia while breathing 100% O<sub>2</sub> for 2 h, and hold while breathing 34% O<sub>2</sub> until BGI = 1.

Finally, Fig. 40 shows 4 options to resolve a bubble by exposure to treatment pressures from 8.2 to 14.0 psia and the use of 100% O<sub>2</sub> by mask to accelerate bubble dissolution. The figure shows BGI dissolution times after returning to saturation pressure at 8.2 psia where DCS is reported after BGI reaches 28.0 at 4.3 psia (horizontal line). DCS occurs 480 min after initial depressurization in the astronaut. There is a 5-min delay to begin a 2-min repressurization to 8.2 psia. The delay allows BGI to increase to 28.2. The astronaut repressurizes to 8.2 psia and breathes 95% O<sub>2</sub> after a suit purge until BGI is 1, the solid baseline curve on the right. It required 275 min from the start of O<sub>2</sub> treatment in the MMSEV at 8.2 psia to reach a BGI of 1. The dashed curves are alternative options where, after breathing 95% O<sub>2</sub> for 2 h in the suit, the astronaut exits the suit and dons a mask with 100% O<sub>2</sub> as the MMSEV cabin pressure is increased to 10.0 psia, or 12.0 psia, or 14.0 psia. The elapsed time from the start of in-suit O<sub>2</sub> treatment to a BGI of 1 is 244 min for exposure to 10.0 psia, 225 min for exposure to 12.0 psia, and 214 min for exposure to 14.0 psia.

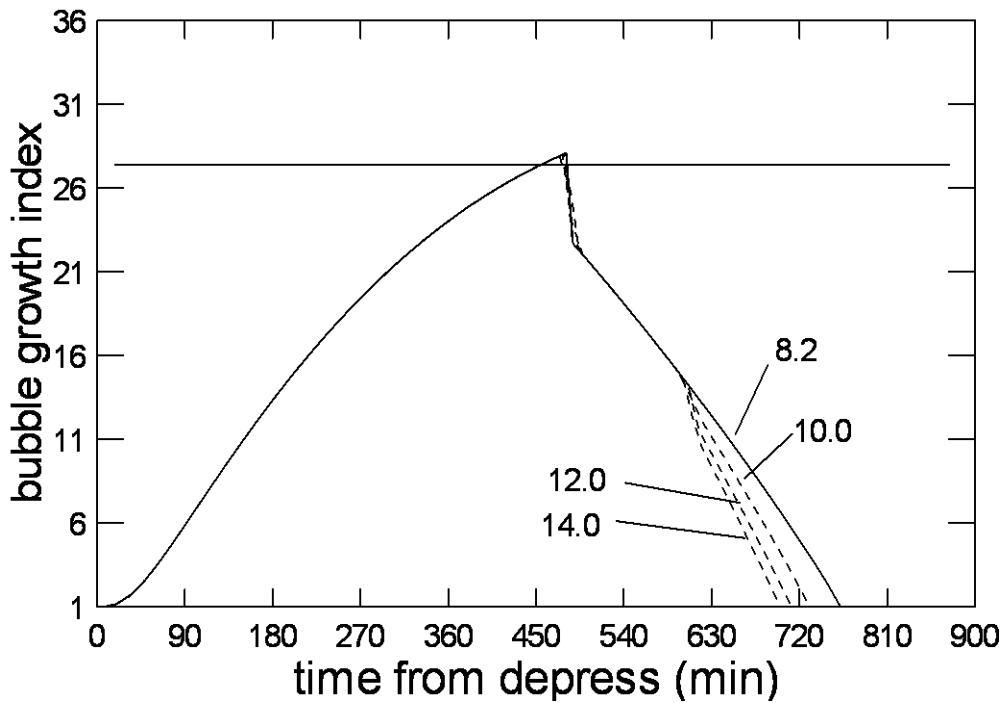

Fig. 40. Four simulated treatment cases in the MMSEV.

Recovery time at 8.2 psia with 34% O<sub>2</sub>, and not 100% O<sub>2</sub> and pressure, is a reasonable treatment strategy *in the case where a symptom clears on repressurization to 8.2 psia*. In other words, intervening with long periods of 100% O<sub>2</sub> and pressures above 8.2 psia are only marginally effective at resolving this simulated bubble. Breathing 100% O<sub>2</sub> by mask presents complicated procedures and is potentially wasteful of limited resources since exhaled O<sub>2</sub> may exceed a 35% upper O<sub>2</sub> concentration limit in the MMSEV atmosphere. Breathing 34% O<sub>2</sub> at 8.2 psia after a 2-h in-suit period with 95% O<sub>2</sub> resolves the BGI to 1.0 after about 320 min compared to 214 min for the best-case scenario of in-suit O<sub>2</sub> for 2 h plus 100% O<sub>2</sub> on a mask while at 14.0 psia in the MMSEV.

### Partial Validation of Hypobaric DCS Treatment Model

Data available from 2013 – 2014 testing of the NASA Micronuclei Research Project at Duke University were assembled as an independent source to validate the treatment model (Pollock *et al.* 2014). Table XIV shows details about the DCS symptoms, observed  $\Delta P$  at symptom resolution, and P(symptom resolution) from the treatment model based on computed  $\Delta P$  from the TBDM at symptom resolution and once the subject reached site pressure.

**Table XIV. Validation Data for Hypobaric DCS Treatment Model**

subject ID	location	symptom onset time (min)	observed $\Delta P$ at symptom resolution (psid)	computed $\Delta P$ at symptom resolution (psid)	P(symptom resolution) $\pm$ 95% CL at resolution	computed $\Delta P$ at site pressure (psid)	P(symptom resolution) $\pm$ 95% CL at site pressure
D130827A*	lt knee	60(1)	4.16	3.55	0.68 (0.51-0.81)	9.96	0.95 (0.88-0.98)
D130827A*	lt ankle	60(1)	4.16	3.55	0.68 (0.51-0.81)	9.96	0.95 (0.88-0.98)
D130904A*	lt knee	62(2)	4.30	3.06	0.61 (0.43-0.76)	9.83	0.94 (0.87-0.98)
D130904B*	lt knee	112(3)	5.81	5.31	0.78 (0.65-0.87)	10.37	0.93 (0.86-0.97)
D131112B*	rt ankle	145(4)	3.66	3.46	0.55 (0.41-0.66)	10.20	0.92 (0.84-0.96)

Note: Subjects ambulated before and during exposure to 4.3 psia.

\*Subject received a prophylactic USN TT V treatment; no symptom was present at site pressure and unknown GLO time before HBO treatment.

(1) Time from ascent to start of repressurization was 112 min; 30 min ascent and then 82 min at 4.3 psia, repressurization from 4.3 psia to site pressure was 7 min.

(2) Time from ascent to start of repressurization was 114 min; 30 min ascent and then 84 min at 4.3 psia, repressurization from 4.3 psia to site pressure was 19 min.

(3) Time from ascent to start of repressurization was 148 min; 30 min ascent and then 118 min at 4.3 psia, repressurization from 4.3 psia to site pressure was 10 min.

(4) Time from ascent to start of repressurization was 189 min; 30 min ascent and then 159 min at 4.3 psia, repressurization from 4.3 psia to site pressure was 5 min.

All 5 mild Type I symptoms in 4 subjects resolved with a mean computed P(symptom resolution) of  $0.66 \pm 0.08$  SD. At site pressure, the mean P(symptom resolution) increased to  $0.94 \pm 0.01$  SD before prophylactic USN TT V treatment. An undefined period of GLO preceded the treatment. These favorable outcomes are attributed, in part, to significant denitrogenation before the exposure and prompt repressurization within 30 min of symptom recognition, conditions that would be present in future EVAs.

An astronaut returning to the MMSEV with a  $\Delta P$  of 3.7 psid and P(symptom resolution) of 0.49 from the examples in Fig. 38 may not have prompt relief of the symptom, according to the validation data. Additional GLO at 8.2 psia, a return to a higher cabin pressure, either in the suit or outside the suit, or a combination of additional treatment pressure and GLO would be necessary to resolve the symptom, according to the treatment model.

### **Combined NASA and USAF Data on Symptom Resolution**

Additional symptom data were obtained from the Air Force Research Laboratory Altitude Decompression Sickness Research Database archived at Wright-Patterson AFB. These data were previously evaluated by Muehlberger *et al.* (2004). The data resemble the limited NASA treatment data in that the cumulative proportion of symptoms that resolved for a given  $\Delta P$  (Muehlberger *et al.*'s Fig. 1) resembles our data (Fig. 5). However, the amount of Muehlberger *et al.*'s data is about 12 times the amount of the NASA data. Table XV summarizes the combined NASA and USAF data on symptom resolution. We take the opportunity here to evaluate additional explanatory variables to describe the P(symptom resolution) in the larger combined data.

Table XV. Combined NASA and USAF Data on Symptom Resolution

symptom category	symptom resolution details	NASA treatment pressure (counts)	USAF treatment pressure (counts)	combined treatment pressure (counts)	% of total 1,919
A	resolved at altitude	37	65	102	5.3
B	resolved on repressurization	121	1,431	1,552	80.8
C	resolved on repressurization but without documented treatment pressure	25	83	108	5.6
D	resolved at site pressure	17	58	75	3.9
E	resolved with HBO	20	62	82	4.3
	total symptoms resolved	220	1,699	1,919	100.0

Fig. 41 shows the cumulative proportion of 1,709 symptoms from combined NASA and USAF sources that resolved at the given  $\Delta P$ , including 75 symptoms that resolved at site pressures between 14.4 and 14.7 psia and 82 symptoms that required 2.8 ATA (41.1 psia) HBO treatment (TT V or VI) for persistent or residual symptoms at site pressure. The 1,709 symptoms are from 372 subjects (299 men and 73 women) with mean age of 30.5 years  $\pm$  6.6 SD. About 95% of all symptoms resolved on return to site pressure over a range of exposure pressures at symptom onset from 2.7 to 9.0 psia.

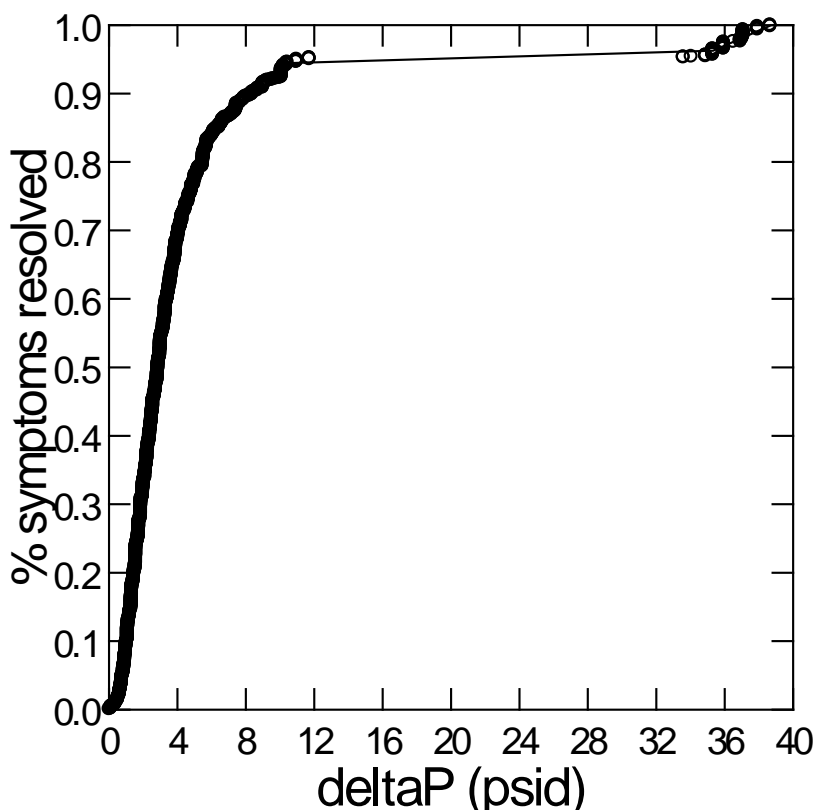
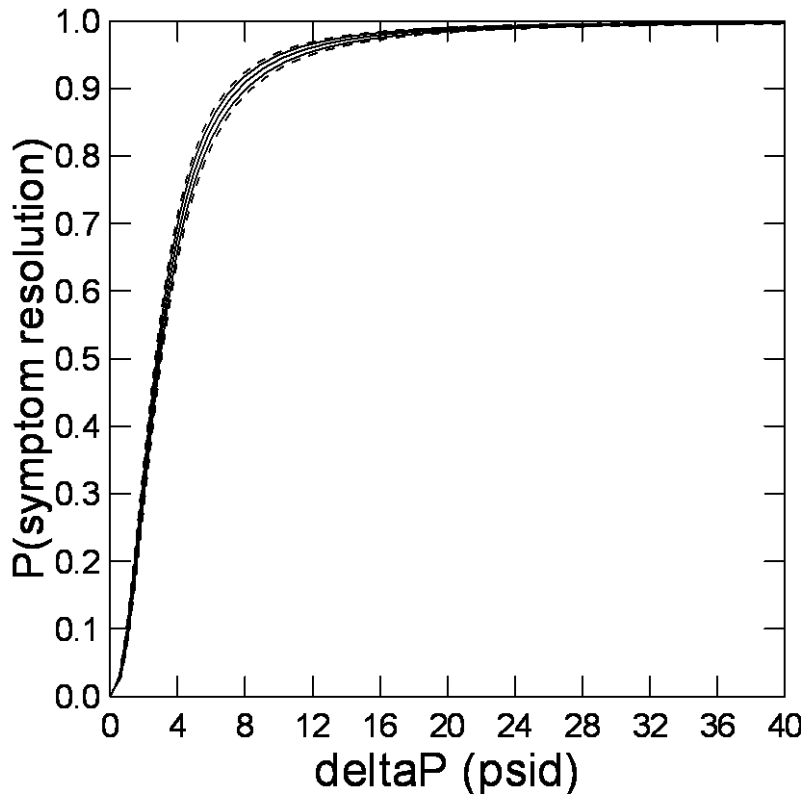

Fig. 41. Cumulative proportion of 1,709 symptoms from NASA and USAF that resolved at the given  $\Delta P$ , the empirical CDF  $[F_n(\Delta P)]$ .



Fig. 42 shows the P(symptom resolution) and 95% CL that account for dependency among the symptoms. The inner solid curves are 95% CL that assume independence among symptoms while the outer dashed curves account for dependency among the symptoms. The differences are small but notable in this large sample of data.



**Fig. 42. P(symptom resolution) based on 1,709 symptoms from USAF and NASA that resolved at a  $\Delta P$  between 0 and 37.9 psid. Dashed 95% CL account for dependency among the symptoms while the solid 95% CL do not.  $P(\text{symptom resolution}) = 1 / (1 + \exp(-(\ln(\Delta P) - 1.0473) / 0.448))$ .**

Several explanatory variables common to both the NASA and USAF symptom data allowed us to fully evaluate them in the combined data. Explanatory variables found significant to include in various regressions include these:

- a)  $P_1$ : the pressure (psia) at which a symptom appears,
- b) AMB: the ambulation status for the tested protocol (ambulation = 1 and nonambulation = 0) even though the nonambulation state represented only 5% (83/1,709) of the symptoms that resolved during repressurization to site pressure or during HBO treatment,
- c) GENDER: male = 1 and female = 0,
- d) TYPE DCS: Type I = 1 and Type II = 0. A symptom was designated as Type I (pain-only or skin manifestations) or Type II (serious). Type I included joint pain, nondermatomal pins-and-needles tingling, pruritus (skin itching), hot and cold sensations, urticaria, edema, muscle pain, and muscle spasm. Type II included fatigue, dizziness,

blurred vision, CM, light-headedness, abnormal reflex, cold sweat, cough, headache, dyspnea, hyperesthesia, substernal distress, numbness, nausea, paresthesia associated with dermatomal distribution, and impaired coordination. The presence of CM by itself or in conjunction with other symptoms was designated as Type II because this was our historical convention. This convention no longer applies when CM appears in isolation from other symptoms. This assemblage of signs and symptoms is not all-inclusive and is how they were categorized for analysis in the combined NASA and USAF sources.

- e) AGE: age of the person in years, and
- f) MAXINTEN: the maximum intensity of the symptom on a 1-10 scale.

Table XVI shows the regression results for all explanatory variables useful to the treatment model.

**Table XVI. Regression Details about Symptom Resolution Model in Combined NASA and USAF Data (N = 1,707)**

parameters	estimate ± 95% CL	standard error*	z-score	P-value
$\beta_1$	0.425 0.40 to 0.45	0.031	-27.46†	<0.001†
$\beta_2$	2.091 1.60 to 2.57	0.247	8.44	<0.001
AMB	-0.461 -0.75 to -0.16	0.151	-3.05	0.002
GENDER	-0.201 -0.35 to -0.05	0.077	-2.59	0.01
TYPE DCS	-0.772 -0.98 to -0.56	0.107	-7.18	<0.001
AGE	0.0092 -0.001 to 0.020	0.0055	1.68	0.092

\*adjusted for dependency among 1,707 symptoms.

† $\beta_1$  is constrained to be positive so its sampling distribution is skewed right, giving a standard error that is not entirely meaningful. It is better to use the standard error for  $\ln(\beta_1)$  to get confidence limits for  $\ln(\beta_1)$ , and then exponentiate to get confidence limits for  $\beta_1$ . For similar reasons, a z-score and P-value for  $H_0: \beta_1 = 0$  do not make sense, as by definition  $\beta_1 > 0$ . The values provided are based on  $\ln(\beta_1)$ .

The  $T_s$  at  $P_1$  was not statistically significant to include in the USAF data or in the combined NASA and USAF data. However,  $T_s$  was significant in just the NASA data (Table XII). The final treatment model with 4 explanatory variables in a large set of data (n=1,707 symptoms) is

$$P(\text{symptom resolution}) = 1 / (1 + \exp(-(\ln(\Delta P) - 2.091 + 0.461 \times \text{AMB} + 0.201 \times \text{GENDER} + 0.772 \times \text{TYPE DCS} - 0.0092 \times \text{AGE}) / 0.425)), \quad \text{Eq. 24}$$

where  $\Delta P$  is a real or computed input from a bubble model and the other explanatory variables are as described above. We consider Eq. 24 to be a general model, suitable for any aviation or even EVA application.

Fig. 43 shows a best-case and a worst-case simulation result based on Eq. 24 where combinations of explanatory variables either increase or decrease the  $P(\text{symptom resolution})$  for a given  $\Delta P$ . A person would require greater  $\Delta P$  if older, if gender is female with a Type II symptom, and if the person is nonambulatory. The difference in  $P(\text{symptom resolution})$  for a given  $\Delta P$  is dramatic, indicating that certain combinations of explanatory variables significantly influence the likelihood of symptom resolution.

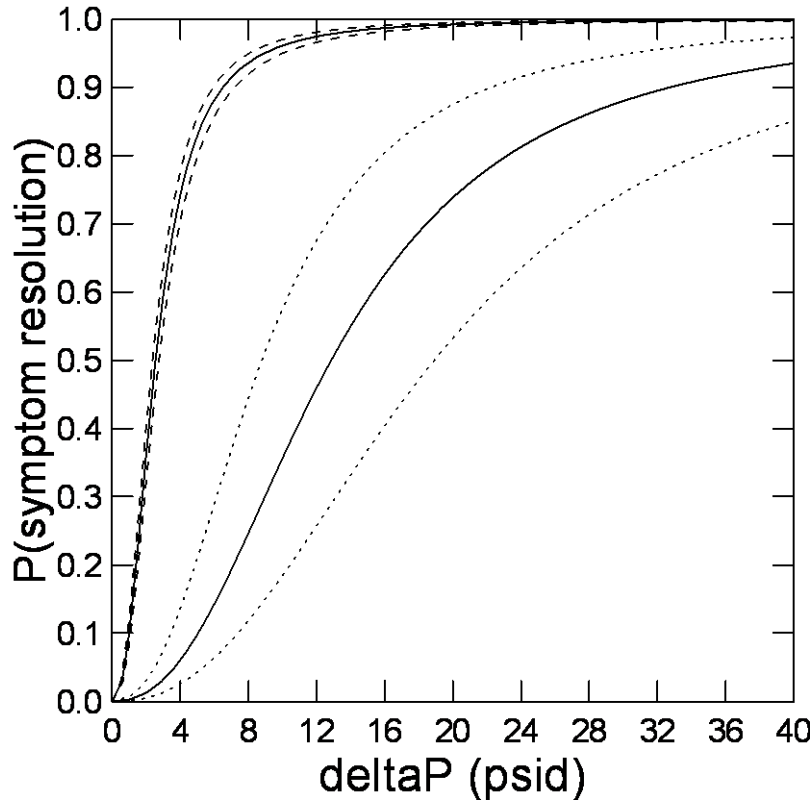

**Fig. 43.  $P(\text{symptom resolution})$  based on 1,707 symptoms that included 82 HBO treatments for symptoms at site pressure. The upper curve simulates a best-case combination of explanatory variables: an ambulatory 30-year-old male subject with a Type I symptom. The lower curve simulates a worst-case combination of explanatory variables: a nonambulatory 50-year-old female subject with a Type II symptom.**

An additional explanatory variable was available, but not available for all symptoms. Including the maximum intensity of the symptom, on a 1 to 10 scale, reduced the sample size from 1,707 to 1,361 symptoms. For completeness, we provide the regression results with maximum intensity as an explanatory variable. We accept that including information about symptom intensity has the consequence of reducing the number of symptoms to evaluate. Several explanatory variables in Table XVI remained significant in the smaller set of data that included maximum symptom intensity. Table XVII shows the regression results after including maximum symptom intensity as an explanatory variable.

**Table XVII. Regression Details about Symptom Resolution Model in Combined NASA and USAF Data (N = 1,361)**

<b>parameters</b>	<b>estimate ± 95% CL</b>	<b>standard error*</b>	<b>z-score</b>	<b>P-value</b>
$\beta_1$	0.395 0.37 to 0.42	0.325	-28.5†	<0.001†
$\beta_2$	1.905 1.30 to 2.50	0.306	6.21	<0.001
AMB	-0.569 -0.90 to -0.23	0.173	-3.28	0.001
$P_1$	-0.0628 -0.115 to -0.009	0.027	-2.29	0.022
GENDER	-0.158 -0.31 to -0.0003	0.080	-1.96	0.049
TYPE DCS	-0.418 -0.69 to -0.14	0.142	-2.94	0.003
AGE	0.0083 -0.002 to 0.018	0.005	1.56	0.120
MAXINTEN	0.055 0.027 to 0.083	0.014	3.83	<0.001

\*adjusted for dependency among 1,361 symptoms.

† $\beta_1$  is constrained to be positive so its sampling distribution is skewed right, giving a standard error that is not entirely meaningful. It is better to use the standard error for  $\ln(\beta_1)$  to get confidence limits for  $\ln(\beta_1)$ , and then exponentiate to get confidence limits for  $\beta_1$ . For similar reasons, a z-score and P-value for  $H_0: \beta_1 = 0$  do not make sense, as by definition  $\beta_1 > 0$ . The values provided are based on  $\ln(\beta_1)$ .

$P_1$  was significant enough to include in the combined NASA and USAF data that also included maximum symptom intensity as an explanatory variable. Age was retained in both models above because it significantly correlated with both gender and ambulation status (Somers' D correlation) even when the P-value was  $> 0.05$ . The treatment model with 6 explanatory variables in a smaller set of data (n = 1,361 symptoms) is

$$P(\text{symptom resolution}) = 1 / (1 + \exp(-(\ln(\Delta P) - 1.905 + 0.569 \times \text{AMB} + 0.0628 \times P_1 + 0.158 \times \text{GENDER} + 0.418 \times \text{TYPE DCS} - 0.0083 \times \text{AGE} - \text{MAXINTEN} \times 0.055) / 0.395)), \quad \text{Eq. 25}$$

where  $\Delta P$  is a real or computed input from a bubble model and the other explanatory variables are as described above. Eq. 25 would be considered if a proper assessment of symptom intensity was available.

Fig. 44 shows a best-case and a worst-case simulation result based on Eq. 25 where the combination of explanatory variables either increases or decreases the P(symptom resolution) for a given  $\Delta P$ . As in Fig. 43, a person would require greater  $\Delta P$  if older, if gender is female with a Type II symptom, if the person is nonambulatory, and now if symptom intensity is high. In addition, a slightly greater  $\Delta P$  is required if the symptom originates at a lower  $P_1$ .

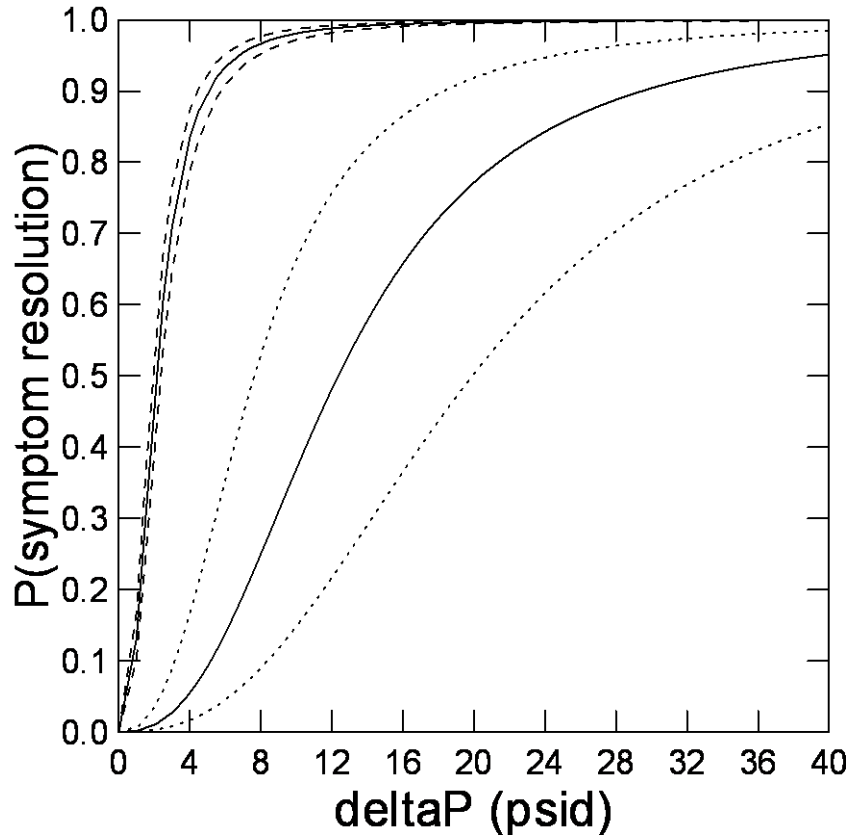

**Fig. 44.  $P(\text{symptom resolution})$  based on 1,361 symptoms that included 36 HBO treatments for symptoms at site pressure. The upper curve simulates a best-case combination of explanatory variables: an ambulatory 30-year-old male subject with a Type I symptom at 6.0 psia with symptom intensity of 2 out of 10. The lower curve simulates a worst-case combination of explanatory variables: nonambulatory 50-year-old female subject with a Type II symptom at 4.0 psia with a reported symptom intensity of 8 out of 10.**

The addition of  $P_1$ , the pressure (psia) at symptom onset, as an explanatory variable significantly improved this regression. The  $P(\text{symptom resolution})$  increases for a given  $\Delta P$  as  $P_1$  increases. The relationship in the combined NASA and USAF data between  $P_1$  and the  $P(\text{symptom resolution})$  was not present in just the NASA data. The dominant exposure pressure in the NASA hypobaric chamber tests was 4.3 psia, being the operating pressure of the spacesuit, whereas the USAF tested over a range of exposure pressures for various Air Force applications. There is a small but statistically significant relationship between  $P_1$  and the  $P(\text{symptom resolution})$  for a given  $\Delta P$  in the combined NASA and USAF data ( $n=1,361$  symptoms). Figure 45 is an example using Eq. 25 to evaluate a simulation. The upper curve is for  $P_1 = 6.5$  psia and the lower curve is for  $P_1 = 3.5$ . A lower  $P_1$  is associated with a lower  $P(\text{symptom resolution})$  for a given  $\Delta P$ . In both simulations, a 30-year-old ambulatory male reports a Type I DCS symptom with an intensity of 5 out of 10.

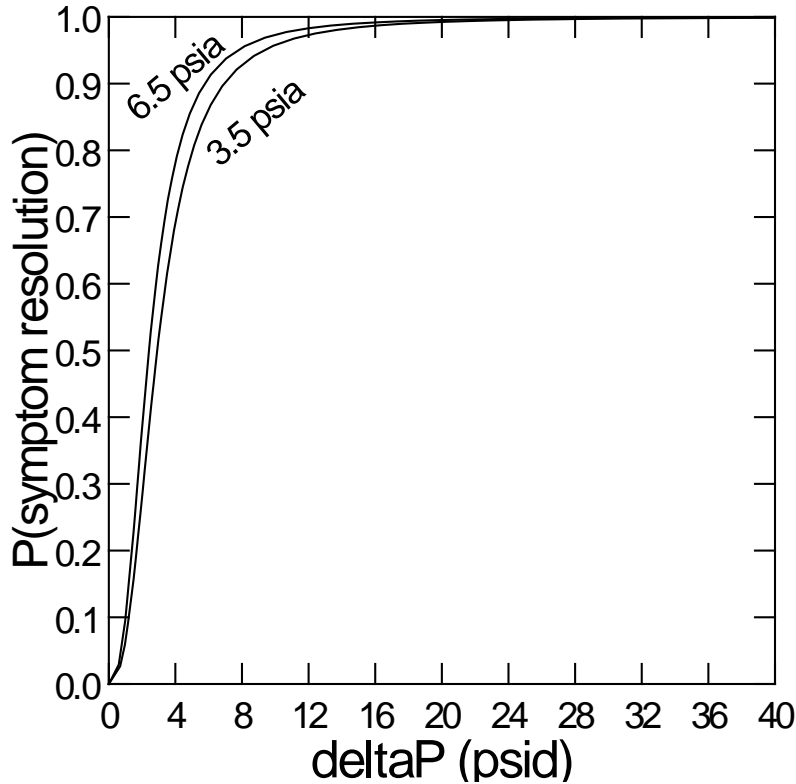

Fig. 45. P(symptom resolution) for a given  $\Delta P$  is associated with the pressure at the onset of a symptom ( $P_1$ ).

### Treatment Model Validation – Combined NASA and USAF Data

Cross-validation is an analytical process to assess how the results of a statistical analysis generalize to an independent set of data. The goal here was to validate the predictability of the 6-parameter treatment model described earlier (Eq. 24), now optimized to a set of training data, by assessing how well the model described an independent set of validation data.

The 1,707 symptom records were first partitioned into complementary subsets – the training and validation sets. If all symptom records were independent, then simply selecting every other record would produce 2 complementary subsets of equal samples. However, many subjects had more than one symptom before repressurization. The approach to create complementary subsets was to select every other *subject* who had contributed to the 1,707 symptom records. As a result, no subject with multiple symptoms had symptoms in both subsets. The resulting training set had 876 symptom records and the validation set had 831 symptom records.

### Visual Validation

With dichotomous data, you have a successful or unsuccessful outcome. A model optimized to dichotomous data computes the probability of the outcome, usually given one or more explanatory variables. An analysis of predicted versus observed outcome within the training set is the basis to assess goodness of fit. But in cross-validation, the optimized model from the training set is used to predict the outcomes in the validation set. In our case, all treatment

outcomes were successful in that all subjects had relief of their symptom(s), relief across a range of  $\Delta P$ . Our approach was to compute probabilities given 4 explanatory variables in the training set and then graph the  $P(\text{symptom resolution})$  and the empirical CDF of symptom resolution [the  $F_n(\Delta P)$ ] against the  $\Delta P$  in the training set. Then we computed the  $P(\text{symptom resolution})$  for all data in the validation set using the treatment model optimized from the training set and graphed the  $P(\text{symptom resolution})$  and the  $F_n(\Delta P)$  against the  $\Delta P$  in the validation set. A comparison of the 2 graphs plus an evaluation of observed  $F_n(\Delta P)$  minus predicted  $P(\text{symptom resolution})$  across the range of  $\Delta P$  were the means by which we validated the treatment model optimized to the training set.

Figure 46 shows the computed  $P(\text{symptom resolution})$  for the  $\Delta P$ s in the training set as X-symbols based on the 6-parameter treatment model optimized to the training set. The 4 explanatory variables and the  $\Delta P$ s for symptom relief for all 876 records created a pattern similar to that of the empirical CDF, seen as O-symbols, over the same range of  $\Delta P$  (also see Fig. 41). A point below or above the  $F_n(\Delta P)$  is from combinations of explanatory variables that reduced or increased the  $P(\text{symptom resolution})$  more than the  $\Delta P$  for symptom resolution would suggest. The observed values from the  $F_n(\Delta P)$  from 876 training records were subtracted from the predicted values [ $P(\text{symptom resolution})$ ] computed from the 6-parameter treatment model for each  $\Delta P$ , and plotted in Fig. 47. The circles above a horizontal line at 0 on the y-axis are results below the empirical  $F_n(\Delta P)$  on Fig. 46. The circles below the horizontal 0-line are from results above the empirical  $F_n(\Delta P)$  on Fig. 46. The mean  $\pm$  SD for the difference between observed and predicted was  $-0.0048 \pm 0.101$  for the 6-parameter treatment model optimized to the training set.

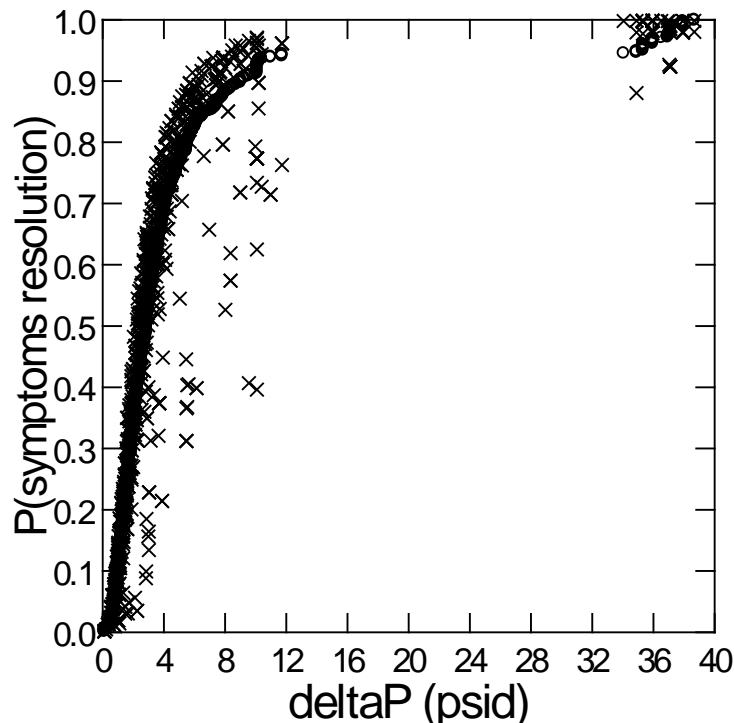

**Fig. 46.** The  $P(\text{symptom resolution})$  with X-symbols compared to the empirical CDF [ $F_n(\Delta P)$ ] of 876 symptoms, with O-symbols from the training set that resolved at the given  $\Delta P$ .

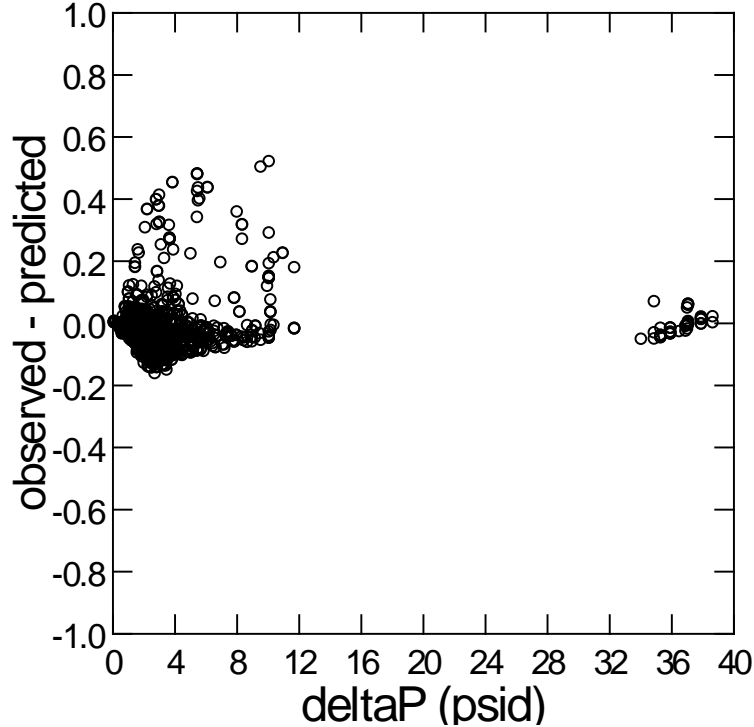

**Fig. 47. The observed empirical CDF  $[F_n(\Delta P)]$  minus the predicted  $P(\text{symptom resolution})$  over the range of  $\Delta P$  from the 6-parameter treatment model, optimized to 876 symptoms in the training set.**

In contrast, Fig. 48 shows the  $P(\text{symptom resolution})$  based on the treatment model optimized to the training set but then applied to the validation set. The model from the training set was evaluated for the  $\Delta P$ s and the 4 explanatory variables in the validation set. The 4 explanatory variables and the  $\Delta P$ s for symptom relief for all 831 records create a pattern similar to that of the empirical CDF, seen as O-symbols, over the same range of  $\Delta P$ . The observed values from the  $F_n(\Delta P)$  from 831 training records was subtracted from the predicted values [ $P(\text{symptom resolution})$ ] computed from the 6-parameter treatment model for each  $\Delta P$  and plotted in Fig. 49. The mean  $\pm$  SD for the difference between observed and predicted was  $-0.017 \pm 0.116$  for the 6-parameter treatment model optimized to the training set but applied to the validation set.

The close visual concordance between the  $P(\text{symptom resolution})$  computed from each of the two sets of data with a treatment model optimized only to the training set is a validation of the treatment model. We have high confidence that the treatment model from the combined set of data ( $N = 1,707$ , Eq. 24) is valid to compute the  $P(\text{symptom resolution})$  in future scenarios when the required explanatory variables are available.



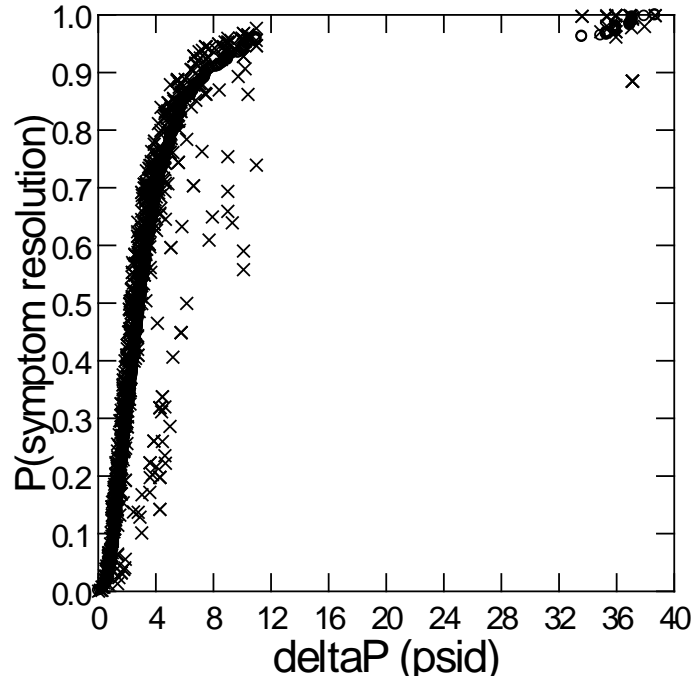

Fig. 48. The P(symptom resolution) with X-symbols compared to the empirical CDF  $[F_n(\Delta P)]$  of 831 symptoms, with O-symbols from the validation set that resolved at the given  $\Delta P$ .

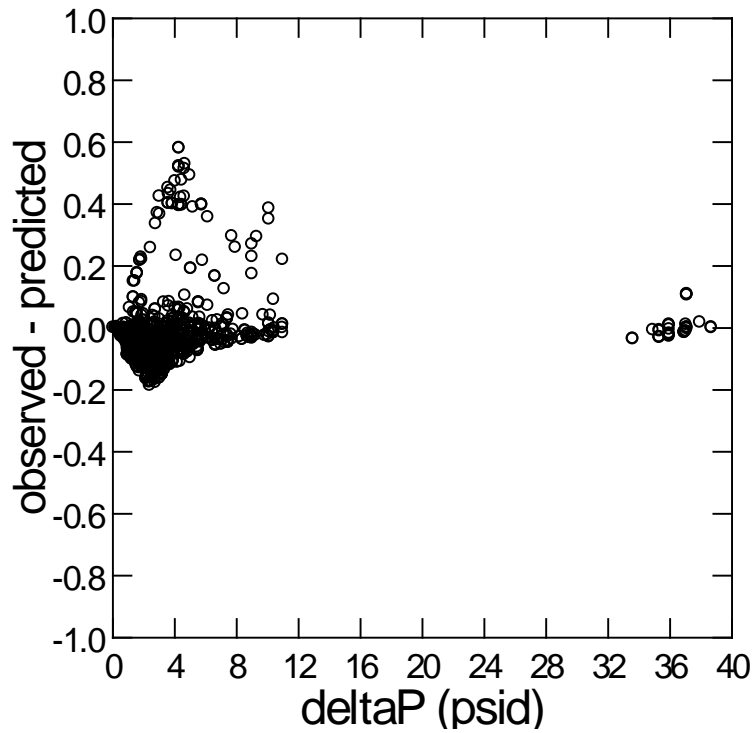

Fig. 49. The observed empirical CDF  $[F_n(\Delta P)]$  minus the predicted P(symptom resolution) over the range of  $\Delta P$  from the 6-parameter treatment model, optimized to 831 symptoms in the training set.

## Discussion

The Hypobaric DCS Treatment Model links a decrease in computed bubble volume from increased  $\Delta P$ , increased  $O_2$  partial pressure, and passage of time during treatment to the P(symptom resolution). The decrease in offending volume is realized in 2 stages: a) during compression via Boyle's law and b) during subsequent dissolution of the gas phase via the  $O_2$  window. The computed  $\Delta P$  from the TBDM for a specific EVA scenario is the effective treatment pressure at any point in time.

The additional step of computing  $\Delta P$  with Eq. 9 given the bubble volume at repressurization minus the bubble volume at symptom resolution ( $\Delta V$ ) computed from the TBDM may seem redundant. In either case, the predictive models would be equivalent. However, those responsible for DCS treatment are accustomed to treating symptoms based on the application of pressure ( $\Delta P$ ) and the use of 100%  $O_2$  through time. Basing the treatment model on  $\Delta P$  and not on  $\Delta V$  is consistent with how physicians treat symptoms.  $\Delta P$ , after all, was based on the  $\Delta V$  of a single gas bubble in a theoretical 360-min half-time tissue compartment. Muehlberger *et al.* (2004) shows the cumulative fraction of symptom resolution as a function of  $\Delta P$ . Without knowing the details of those exposures, it is not possible to compute a  $\Delta V$  through the TBDM. However, a computed  $\Delta P$  for a particular simulated exposure from the TBDM, or any other bubble model, links the simulation result to our empirical  $\Delta P$  data and other published  $\Delta P$  data.

Decompression sickness during exploration-class EVAs is unlikely to occur as a conservative PB protocol will be used by the astronauts, yet we cannot say with certainty that DCS will never occur during such EVAs. Therefore, the events of developing and subsequently resolving a DCS symptom must be treated probabilistically in mission planning. With this in mind, our survival and treatment models can be used to estimate  $Q$  (Eq. 23), the probability of a DCS symptom occurring and not resolving under treatment at maximum designed  $\Delta P$  capability. If the risk (quantified by the value of  $Q$ ) is unacceptably high, then an alternative treatment option is evaluated that combines the max  $\Delta P$  with a period of 100%  $O_2$  breathing to raise the effective treatment pressure to a level such that  $Q$  is acceptable.

The effort to develop Eq. 23 was motivated by discussions about the link between  $P(DCS)_t$  and P(symptom resolution), both being aspects of the same process. There is a probability of response and a probability of recovery. The details and magnitude of the response necessarily dictate the details and magnitude of the recovery. Knowing something about the  $P(DCS)_t$  means knowing something about the P(symptom resolution), and *vice versa*. We suppose that the  $P(DCS)_t$  is linked to the intensity of a symptom (Allen *et al.* 1971 (Fig. 6), Conkin *et al.* 1998) which, in turn, is linked to the onset time of a symptom (Fig. 7), which we showed here is linked to the P(symptom resolution). A high-probability case of DCS is still a case of DCS but fundamentally means those many with DCS may have higher symptom intensity with shorter onset times. Conversely, a low-probability case of DCS is still a case of DCS but fundamentally means that those few subjects who develop DCS may have lower symptom intensity with longer onset times. Eq. 23 (see Overall Risk Model for Future Missions) is the first effort to combine all we know about a hypobaric exposure and response to treatment to compute a single P(DCS without resolution). The objective is to plan the EVA and treatment resources to minimize the P(DCS without resolution).

We have proposed a method for calculating the effective treatment pressure using a model (TBDM) of bubble growth that assumes the behavior of a single bubble in a unit volume of tissue is representative of the behavior of an aggregate of thousands of bubbles in a larger volume of tissue, since hydrostatic pressure is transmitted equally throughout the body during treatment. In particular, under this assumption, a change in one bubble would be similar to that in all bubbles regardless of where in the body a symptom originates. This assumption is certainly suspect, considering that different symptoms can originate from different tissues through mechanical deformation or ischemia, or both. Furthermore, the final dissolution of a gas phase by the O<sub>2</sub> window is specific to the local perfusion and metabolic conditions in the tissue, in our case a theoretical 360 half-time compartment. Other models of bubble-tissue systems (Srinivasan & Gerth 2013, Nikolaev 2013) can be used to compute effective treatment pressure. Whether these models account for single or multiple bubbles, use 30 or 50 dyne / cm for surface tension, with or without a term for deformation pressure, whether they account for the O<sub>2</sub> window in a simple or complex fashion, or other details about diffusion of gases through a boundary layer, we suspect (future work) that the differences in computed  $\Delta P$  between different models would be small. The differences in these bubble models seem minor while the fundamental physics of bubble growth and resolution seem similar in all model systems, especially in light of the considerable individual variation in propensity for DCS. For these reasons, we would expect that the difference in computed effective treatment pressures between different models for identical treatment scenarios would be small, maybe no more than  $\pm 0.5$  psid. A difference in P(symptom resolution) given small differences in  $\Delta P$  is acceptable in an operational context. Future work would be needed to verify our suspicion through collaboration with others who have developed bubble models that differ from the TBDM. Any biophysical model that uses the expansion or contraction of a single spherical bubble in a unit volume of tissue as the only explanation for DCS incidence, type of symptom, onset time, symptom intensity, and symptom resolution would be unrealistic in mechanistic terms. Nevertheless, we think the TBDM, as implemented here in combination with the log-logistic models for P(symptom resolution) and P(DCS)<sub>t</sub>, provides a pragmatic and utilitarian means for taking the possibility of DCS into account when planning future space missions.

The Hypobaric DCS Treatment Model applies to astronauts that are protected from DCS through an effective PB protocol. Astronauts will also be educated about the early recognition and prompt treatment of symptoms. Eq. 22, specific to our discussion about astronauts, is  $P(\text{symptom resolution}) = 1 / (1 + \exp(-(\ln(\Delta P) - 1.510 + 0.795 \times \text{AMB} - 0.00308 \times T_s) / 0.478))$ , where  $\Delta P$  (psid) is known or computed from the TBDM; AMB = 1 if ambulation takes place during the EVA, otherwise AMB = 0; and T<sub>s</sub> is the elapsed time in min from the start of the EVA to recognition of a DCS symptom. Ambulation on a planetary surface certainly contributes to symptoms in the lower body and to the P(symptom resolution) given a particular  $\Delta P$  and T<sub>s</sub>. EVAs in space would not have the ambulation component. For reasons not mechanistically apparent, our analysis shows that the nonambulation case would require additional treatment resources to resolve a symptom. Values of  $\Delta P$  as inputs to the model are calculated from the TBDM based on the effective treatment pressure:  $\Delta P = P_2 - P_1 \mid = P_1 \times V_1 / V_2 - P_1$ , where V<sub>1</sub> is the computed volume of a spherical bubble in a unit volume of tissue at low pressure P<sub>1</sub> and V<sub>2</sub> is computed volume after a change to a higher pressure P<sub>2</sub>. If 100% GLO was breathed in place of air or O<sub>2</sub>-enriched air, then V<sub>2</sub> continues to decrease through time at P<sub>2</sub> at a faster rate. This

calculated value of  $\Delta P$  then represents the effective treatment pressure at any point in time. Time is not explicit in the treatment model. However, the time needed to achieve a particular  $\Delta P$  is available from the TBDM and is the best estimate at this time for the time of P(symptom resolution).

An example here highlights treatment considerations leading to a final treatment strategy. A simulation of a Type I symptom at 203 min into an ambulatory EVA at 4.3 psia on Mars results in a P(symptom resolution) of 0.49 on immediate return to 8.2 psia in the MMSEV. The 95% CL are 0.36 to 0.62. The P(symptom resolution) increases to near certainty (0.99) after 2 h of GLO at 8.2 psia or with less certainty on immediate repressurization to 14.7 psia [0.90 (0.83 – 0.95)]. Treatment options, constrained by limited resources at a remote location, are considered to maximize a successful treatment outcome. In this example, combinations of pressure, O<sub>2</sub>, and time to achieve  $\geq 0.75$  P(symptom resolution) at the lower 95% CL is accepted as a working balance between resource allocation and a successful treatment outcome. A Mission Manager must balance the availability of resources either to pressurize the MMSEV from 8.2 to 14.7 psia or to proceed with GLO in the suit while at 8.2 psia, or some other combination of habitat and suit pressurization and the availability of an O<sub>2</sub>-enriched breathing gas. One other consideration is that a future variable-pressure EVA suit will afford the opportunity to initiate rapid treatment, thus making time available to plan and execute definitive treatment. The treatment model becomes a tool for making a decision on how to proceed to resolve a symptom while minimizing treatment resources. *Given the low probability of DCS during EVA and the prompt treatment of a symptom with guidance from the model, the symptom and the gas phase are likely to resolve with minimal resources and minimal impact to astronaut health, safety, and productivity.*

Our confidence in the treatment model is based on limited validation with data from recent testing of the NASA Micronuclei Research Project at Duke University, from published data from Muehlberger *et al.* (2004), and from our cross-validation analysis of combined NASA and USAF data. However, model validation pertaining to the benefit of GLO for resolving a symptom was not possible, as MOs responsible for subject safety initiated HBO treatments for persistent symptoms rather than monitoring the course of GLO treatment. We have no data about symptom resolution for the case where repressurization was stopped for an extended period at less than site pressure, and found only one report (Krause & Pilmanis 2000) with limited information on the effectiveness of GLO in treating hypobaric DCS. The contribution to the computed effective treatment pressure from Eq. 9 beyond Boyle's law compression is through a bubble model that quantifies a decrease in bubble volume once the repressurization step is over. Therefore, *the untested hypothesis* is that the combination of Boyle's law from initial (P<sub>1</sub>) to final (P<sub>2</sub>) pressure, and continued bubble dissolution at P<sub>2</sub> is indeed the effective treatment pressure over the interval dictated by the TBDM. Results from testing this hypothesis, plus rigorous model validation, await new data. Subjects must be willing to be monitored under various treatment scenarios, for example with different values of P<sub>2</sub> over extended periods, with and without GLO. Those charged with subject safety must allow careful monitoring of alternative treatment options, to accumulate these results for model validation.

We consider Eq. 22 to be the best specific guidance to estimate the P(symptom resolution) for astronauts, as the 154 symptoms are from PB protocols specifically tested to support EVAs at 4.3 psia. However, Eq. 24 (from 1,707 symptoms) and Eq. 24 (from 1,361 symptoms) from the

combined NASA and USAF data provides important additional guidance. Eq. 22 requires only  $T_s$  and ambulation status plus an actual  $\Delta P$  or computed  $\Delta P$  from the TBDM, with an assumption that  $P_1$  is 4.3 psia. Eqs. 24 and 25 require additional information about the astronaut (gender, age) and about the symptom ( $P_1$ , symptom classification, and symptom intensity) in addition to the ambulation status plus an actual  $\Delta P$  or computed  $\Delta P$  from the TBDM. The example used earlier highlights differences in  $P(\text{symptom resolution})$  when Eq. 22 is compared to Eq. 25. An unclassified symptom appears at 203 min into an ambulatory EVA at 4.3 psia on Mars. There is a 20-min delay on the return to 8.2 psia in the MMSEV, and the resulting  $P(\text{symptom resolution})$  is 0.49 from Eq. 22. Had  $T_s$  been the same at 203 min into the EVA but the symptom was specifically classified as Type I DCS pain in a knee with an intensity of 5 out of 10 in a female astronaut 40 years of age, then for the same computed  $\Delta P$  of 3.76 psid from the TBDM the  $P(\text{symptom resolution})$  is 0.54. The estimates are similar, especially when overlapping CL are considered. Now consider a male astronaut 50 years of age with substernal discomfort classified as Type II DCS with intensity of 8 out of 10, and all else equal as above. The  $P(\text{symptom resolution})$  in this cases decreases to 0.24, which would be assessed with Eq. 22 as 0.49. Clearly, additional treatment intervention, such as treatment pressure greater than 8.2 psia or a period of GLO, should be considered according to Eq. 25. Equations 24 and 25 are available to supplement Eq. 22, especially when detailed information about the symptom is available.

Finally, regardless of whether a treatment option is more or less effective, the passage of time almost always improves the outcome. Any residual symptom after a treatment will eventually resolve because metabolizing tissues reabsorb a gas phase. Michael Collins on Gemini X and again on Apollo 11, retrospectively, reported a pain in his left knee consistent with Type I DCS (Hawkins & Zieglschmid 1975). He described the onset of pain shortly upon orbital insertion after the capsule depressurized to 5 psia with 100%  $O_2$ , with pain eventually resolving. Our data also show that about 17% of symptoms (see Table III and Fig. 17) resolved at the test altitude if subjects continued past the point of initial symptom recognition. In astronauts protected through prior denitrogenation, breathing 100%  $O_2$  during EVA is treatment for DCS given that the symptom is tolerable for the time it takes to reduce the gas phase. There is a competition for  $N_2$  molecules during EVA and  $N_2$  diffuses into either a bubble or the alveolar space. This competition is clearly evident when the lag, response, and recovery phase of VGE transported through the pulmonary artery are measured (Conkin *et al.* 1996a). Treating a symptom by ignoring the symptom is not a treatment option that we endorse, but highlights the reality that most cases of hypobaric DCS are self-limiting when preceded by some denitrogenation and the use of 100%  $O_2$  to prevent anoxia during the hypobaric exposure.

## Acknowledgments

We thank Steven R. Francis for his initial review of data as part of the October 2012 Aerospace Medicine Clerkship program, Matthew D. Koslovsky for his initial statistical analysis as part of a June 2013 summer internship program, and Joseph Vojtko for providing historical context about diver and aviator decompression sickness as part of the October 2013 Aerospace Medicine Clerkship program, all at the Johnson Space Center. Daniel T. Fitzpatrick provided a technical review of the hypobaric decompression sickness treatment model based on his specialized training in hyperbaric oxygen treatment. Andrew D. Dawson provided valuable consultation about the computer computation of the Tissue Bubble Dynamics Model. James T. Webb was instrumental in providing 1,699 symptom records from the Air Force Research Laboratory Altitude Decompression Sickness Research Database archived at Wright-Patterson Air Force Base, a windfall of data that ultimately enhances astronaut safety. Neal W. Pollock, along with the decompression sickness research staff at Duke University, provided valuable data that aided in the partial validation of the treatment model. We also thank Jane M. Krauhs for editing the long manuscript. This report was made possible through a National Aeronautics and Space Administration Cooperative Agreement (NNJ11HE31A) with the Universities Space Research Association. Conclusions are those of the authors and are not necessarily endorsed by the National Aeronautics and Space Administration.

## References

- Abercromby AJF, Gernhardt ML, Conkin J. Fifteen-minute extravehicular activity prebreathe protocol using NASA's exploration atmosphere (8.2 psia / 34% O<sub>2</sub>). *Acta Astronaut* 2014; (in press).
- Adler HF. Dysbarism. *Aeromedical Review* 1-64. Brooks Air Force Base, TX; 1964.
- Allen TH, Maio DA, Bancroft RW. Body fat, denitrogenation and decompression sickness in men exercising after abrupt exposure to altitude. *Aerospace Med* 1971; 42:518-24.
- Ballidin UI, Pilmanis AA, Webb JT. Central nervous system decompression sickness and venous gas emboli in hypobaric conditions. *Aviat Space Environ Med*. 2004; 75:969-72.
- Barratt MR (ed). *Space Station Hyperbaric Medicine Ad Hoc Committee Meeting*. NASA Conference Publication 10140, Houston, TX: NASA Johnson Space Center, January 1996.
- Butler WP, Topper SM, Dart TS. USAF treatment table 8: treatment for altitude decompression sickness. *Aviat Space Environ Med* 2002; 73:46-9.
- Conkin J. A log-logistic survival model applied to hypobaric decompression sickness. In: Weathersby PK, Gerth WA (ed.). *Survival Analysis and Maximum Likelihood Techniques as Applied to Physiological Modeling*. 51<sup>st</sup> Workshop of the Undersea and Hyperbaric Medical Society, Seattle, WA, 19 May, 1998, Kensington, MD: Undersea and Hyperbaric Medical Society; 75-93.
- Conkin J. Evidence-based approach to the analysis of serious decompression sickness with application to EVA astronauts. Houston, TX: NASA Johnson Space Center; January 2001. NASA Technical Publication 2001-210196.
- Conkin J, Foster PP, Powell MR, Waligora JM. Relationship of the time course of venous gas bubbles to altitude decompression illness. *Undersea Hyperbaric Med* 1996a; 23:141-49.
- Conkin J, Foster PP, Powell MR. Evolved gas, pain, the power law, and probability of hypobaric decompression sickness. *Aviat Space Environ Med* 1998; 69:352-9.
- Conkin J, Gernhardt ML, Powell MR, Pollock NW. A probability model of decompression sickness at 4.3 psia after exercise prebreathe. Houston, TX: NASA Johnson Space Center; December 2004. NASA Technical Publication 2004-213158.
- Conkin J, Klein JS, Acock KE. Description of 103 Cases of Hypobaric Decompression Sickness from NASA-sponsored Research (1982 to 1999). Houston, TX: NASA Johnson Space Center; July 2003. NASA Technical Publication 2003-212052.

- Conkin J, Kumar KV, Powell MR, Foster PP, Waligora JM. A probability model of hypobaric decompression sickness based on 66 chamber tests. *Aviat Space Environ Med* 1996b; 67:176-83.
- Conkin J, Pilmanis AA, Webb JT. Case descriptions and observations about cutis marmorata from hypobaric decompressions. Houston, TX: NASA Johnson Space Center; March 2002. NASA Technical Publication 2002-210779.
- Cox DR, Oakes D. *Analysis of Survival Data*. New York, NY: Chapman and Hall; 1984:13-21.
- Dart TS, Butler WP. Towards new paradigms for the treatment of hypobaric decompression sickness. *Aviat Space Environ Med* 1998; 69:403-9.
- Davis JC. *Treatment of Serious Decompression Sickness and Arterial Gas Embolism*. 20<sup>th</sup> Undersea and Hyperbaric Medical Society Workshop. Bethesda, MD: Undersea and Hyperbaric Medical Society (UHMS); 1979. UHMS Publication No. 34WS(SDS) 11-30-79.
- Degner EA, Ikels KG, Allen TH. Dissolved nitrogen and bends in oxygen-nitrogen mixtures during exercise at decreased pressures. *Aerospace Med* 1965; 36:418-25.
- Dixon JP. Death from altitude-induced decompression sickness: major pathophysiologic factors. In: Pilmanis AA, ed. Proceedings of the 1990 Hypobaric Decompression Sickness Workshop. Brooks Air Force Base, TX (Air Force Systems Command, Armstrong Laboratory, Crew technology Division, Crew Systems Directorate), 16-18 October 1990. Alexandria, VA: Aerospace Medical Association, 1992. Report AL-SR-1992-0005, p. 97-105.
- Dowell GL. Rationale for a hyperbaric treatment capability at a lunar station. *Aviat Space Environ Med* 1993; 64:243-6.
- Elliott DH, Moon RE. Manifestations of the decompression disorders. In: Bennett PB, Elliott DH, eds. *The Physiology and Medicine of Diving*. 4<sup>th</sup> ed. Philadelphia, PA: Saunders; 1993:481-505.
- Francis TJR, Smith D, eds. *Describing Decompression Illness*. 42<sup>nd</sup> Undersea and hyperbaric Medical Society Workshop. Bethesda, MD.: Undersea and Hyperbaric Medical Society (UHMS); 1991. UHMS Publication No. 79(DECO) 5-15-91.
- Fryer DI. Subatmospheric Decompression Sickness in Man. Publication No. AGARD-OGRAPH-125. Advisory Group for Aerospace Research and Development Neuilly-Sur-Seine (France), 1969. Slough, England: Engelhard Hanovia International, Ltd. 1969.
- Gernhardt ML. Development and Evaluation of a Decompression Stress Index Based on Tissue Bubble Dynamics [dissertation]. Philadelphia, PA: University of Pennsylvania; 1991.



- Gerth WA, Vann RD. Probabilistic gas and bubble dynamics models of DCS occurrence in air and nitrogen-oxygen diving. *Undersea Hyperb Med* 1997; 24:275-92.
- Hawkins WR, Zieglschmid JF. Clinical aspects of crew health. In: Johnston RS, Dietlein LF, Berry CA, eds. *Biomedical Results of Apollo*. Washington, DC: Government Printing Office; 1975:70. NASA SP-368.
- Hennessy TR, Hempleman HV. An examination of critical released gas volume concept in decompression sickness. *Proc R Soc Lond* 1977;197:299-313.
- Hills BA. Mechanical vs. ischemic mechanisms for decompression sickness. *Aviat Space Environ Med* 1979; 50:363-7.
- Hlastala MP, Berger AJ. *Physiology of Respiration*, 2<sup>nd</sup> ed. New York, NY: Oxford University Press; 2001:192-4.
- Jersey SL, Baril RT, McCarty RD, Millhouse CM. Severe neurological decompression sickness in a U-2 pilot. *Aviat Space Environ Med* 2010; 81:64-8.
- John-Baptiste A, Cook T, Straus S, Naglie G, Gray G, Tomlinson G, Krahn M. Decision analysis in aerospace medicine: costs and benefits of a hyperbaric facility in space. *Aviat Space Environ Med* 2006; 77:434-43.
- Johnson Space Center. Decompression Sickness Manual JPD 1800.3C, Houston, TX: NASA Johnson Space Center, 2014.
- Krause KM, Pilmanis AA. The effectiveness of ground-level oxygen treatment for altitude decompression sickness in human research subjects. *Aviat Space Environ Med* 2000; 71:115-8.
- Lee ET. *Statistical Methods for Survival Data Analysis*, 2<sup>nd</sup> ed. New York, NY: John Wiley and Sons; 1992:8-18 and 191-93.
- MED EVAL DCS 31001. Medical Operations Medical Evaluation of Decompression Sickness (DCS). December 2012. NASA.
- Moon RE, Gorman DF. Treatment of decompression disorders. In: Brubakk AO, Neuman TS, eds. *The Physiology and Medicine of Diving*. 5<sup>th</sup> ed. New York, NY: Saunders; 2003:600-50.
- Muehlberger PM, Pilmanis AA, Webb JT, Olson JE. Altitude decompression sickness symptom resolution during descent to ground-level. *Aviat Space Environ Med* 2004; 75:496-99.
- Nikolaev VP. Simulation of gas bubble growth and dissolution in human tissues during dives and recompression. *Aviat Space Environ Med* 2013; 84:938-45.

- Nims LF. Environmental factors affecting decompression sickness. Part I: Physical theory of decompression sickness. In: Fulton JF, ed. *Decompression Sickness*. Philadelphia, PA: WB Saunders; 1951;192-222.
- Norfleet WT. Options and plans for treatment of decompression sickness aboard space station freedom. In: Pilmanis AA, ed. Proceedings of the 1990 Hypobaric Decompression Sickness Workshop, Brooks Air Force Base, TX (Air Force Systems Command, Armstrong Laboratory, Crew Technology Division, Crew Systems Directorate), 16-18 October 1990. Alexandria, VA: Aerospace Medical Association, 1992. AL-SR-1992-0005, p. 315-25.
- Norfleet WT. Decompression-related disorders: decompression sickness, arterial gas embolism, and ebullism syndrome. In: Barratt MR, Pool SL, eds. *Principles of Clinical Medicine for Space Flight*. New York, NY: Springer; 2008:223-46.
- Olszowka AJ, Farhi LE. A system of digital computer subroutines for blood gas calculations. *Respir Physiol* 1968; 4:270-80.
- Piccard J. Aeroemphysema and the birth of gas bubbles. *Proc Mayo Clinic*. 1941;16:700-4.
- Pollock NW, Natoli MJ, Conkin J, Wessel JH, III, Gernhardt ML. Ambulation increases decompression sickness in altitude exposure. 2014 Annual Scientific Meeting of the Aerospace Medical Association, San Diego, California, Abstract No. 391, pp. 329, May 10-15.
- Royall RM. Model robust confidence intervals using maximum likelihood estimators. *Int Stat Rev* 1986; 54:221-6.
- Rudge FW. The role of ground-level oxygen in the treatment of altitude chamber decompression sickness. *Aviat Space Environ Med* 1992; 63:1102-5.
- Ryles MT, Pilmanis AA. The initial signs and symptoms of altitude decompression sickness. *Aviat Space Environ Med* 1996; 67:983-9.
- Snow TJ. EVA Console Handbook. Houston, TX: NASA Johnson Space Center; September 2001. JSC-20597, Rev. C, PCN-1, pp. 9.2-1 – 9.2-8.
- Srinivasan RS, Gerth WA. Mathematical models of diffusion-limited gas bubble evolution in perfused tissue. Panama City, FL: Navy Experimental Diving Unit; August 2013. NEDU TR 13-05.
- Srinivasan RS, Gerth WA, Powell MR. Mathematical model of diffusion-limited evolution of multiple gas bubbles in tissue. *Ann Biomed Eng* 2003; 31:471-481.
- StataCorp. *Stata Statistical Software: Release 13*. College Station, TX: StataCorp LP; 2013.

- Steinberg D, Preston D, Clarkson D, Colla P. Survival analysis: supplementary module for SYSTAT 13 (Chap. 12). In: *SYSTAT13: Statistics IV*, Chicago, IL: SYSTAT Software, Inc.; 2009: IV-401-68.
- Stepanek J. Decompression sickness. In: DeHart RL, Davis JR, eds. *Fundamentals of Aerospace Medicine*. 3<sup>ed</sup> ed. Philadelphia, PA: Lippincott Williams & Wilkins; 2002:80-98.
- Stepanek J, Webb JT. Physiology of decompressive stress. In: Davis JR, Johnson R, Stepanek J, Fogarty JA, eds. *Fundamentals of Aerospace Medicine*. 4<sup>th</sup> ed. Philadelphia, PA: Lippincott Williams & Wilkins; 2008:46-82.
- Tikusis P, Gault KA, Nishi RY. Prediction of decompression illness using bubble models. *Undersea Hyperb Med* 1994; 21:129-143.
- Tikusis P, Gerth WA. Decompression theory. In: Brubakk AO, Neuman TS, eds. *The Physiology and Medicine of Diving*. 5<sup>th</sup> ed. New York, NY: Saunders; 2003:419-454.
- Van Liew HD, Burkard ME. Simulation of gas bubbles in hypobaric decompressions: roles of O<sub>2</sub>, CO<sub>2</sub>, and H<sub>2</sub>O. *Aviat Space Environ Med* 1995; 66:50-5.
- Van Liew HD, Conkin J, Burkard ME. The oxygen window and decompression bubbles: estimates and significance. *Aviat Space Environ Med* 1993; 64:859-65.
- Van Liew HD, Hlastala MP. Influence of bubble size and blood perfusion on absorption of gas bubbles in tissues. *Resp Physiol* 1969; 7:111-21.
- Waligora JM, Horrigan DJ Jr, Conkin J, Hadley AT III. Verification of an altitude decompression sickness protocol for Shuttle operations utilizing a 10.2 psi pressure stage. NASA Technical Memorandum 58259, NASA Johnson Space Center, Houston, TX, June 1984. [http://ntrs.nasa.gov/archive/nasa/casi.ntrs.nasa.gov/19840020323\\_1984020323.pdf](http://ntrs.nasa.gov/archive/nasa/casi.ntrs.nasa.gov/19840020323_1984020323.pdf)
- Weathersby PK, Homer LD, Flynn ET. On the likelihood of decompression sickness. *J Appl Physiol* 1984; 57:815-25.
- Yount DE. Skins of varying permeability: a stabilization mechanism for gas cavitation nuclei. *J Acoust Soc Am* 1979; 65:1429-39.

## Appendix I: ISS Aeromedical Flight Rule B13-259

B13-259 Decompression sickness response and treatment [rC] [E]  
[J] ®[062603-6027 ] ®[ED ]

A. DEORBIT REQUIREMENTS: ®[101499-7038 ] ®[082301-4745] ®[092607-8602B]

1. FOR ALL LEVELS OF DCS WHICH RESOLVE WITH TREATMENT, THERE IS NO REQUIREMENT FOR EMERGENCY DEORBIT.

*If symptoms resolve with treatment, there is a low risk of recurring symptoms and injury to the crewmember. Therefore, the risk of an emergency return is not warranted. However, based on specific symptoms and response to treatment, Surgeon may request the affected crewmember be returned to Earth before the normal end of mission.*

2. FOR ALL CUFF CLASS 1 SYMPTOMS, OR CUFF CLASS 2 AND 3 SYMPTOMS WHICH RESOLVE WITH TREATMENT, THERE IS NO REQUIREMENT FOR ANY EARLY MISSION TERMINATION.
3. EARLY DEORBIT WILL GENERALLY NOT BE CONSIDERED FOR UNRESOLVED NON-CUFF CLASS 4 SYMPTOMS UNLESS MEDICAL JUDGMENT DEEMS THE SYMPTOMS ARE PROGRESSING AND/OR ENDANGER CREW HEALTH AND SAFETY.

*98.6 percent or more of non-Cuff Class 4 symptoms resolve with ground-level O<sub>2</sub>, so we would expect them to resolve with our on-orbit treatments. Additionally, we have data and experience that clearly suggest the suit creates residual symptoms, pain, and paresthesia that are consistent with non-Cuff Class 4 DCS. Also, data indicates there is no long term injury associated with unresolved non-Cuff Class 4 symptoms.* ®[082301-4745 ] ®[092607-8602B]

**This Rule Continued on Next Page**

B13-259

Decompression sickness response and treatment  
[rC] [E] [J] (Continued)

- B. FOR UNRESOLVED CUFF CLASS 4 SYMPTOMS, ALL ATTEMPTS WILL BE MADE TO TREAT USING THE ON-ORBIT PROTOCOLS. REPEAT TREATMENTS WILL BE PERFORMED UNTIL THERE IS NO FURTHER MEDICAL IMPROVEMENT. @[101499-7038 ] @[092607-8602B]

*Return of a crewmember with severe Type II DCS is most likely not survivable on the Soyuz because adequate medical support cannot be provided.*

@[101499-7038 ]

- C. THE CAPABILITY OF THE AFFECTED CREWMEMBER TO RETURN TO DUTY AND TO EVA AFTER TREATMENT WILL BE DETERMINED BY THE SURGEON CONSISTENT WITH NASA JSC DECOMPRESSION SICKNESS PROCEDURES AND GUIDELINES, JPG 1800.2B.
- D. THE SUIT WILL REMAIN IN THE PRESS MODE OR AT BTA TREATMENT PRESSURE AS SUPPORTED BY SUIT CONSUMABLES. THE BTA CAN BE INSTALLED TO PROVIDE THE MAXIMUM PRESSURE IN THE SUIT FOR TREATMENT. @[082301-4745 ]

*The BTA can now be installed without depressurizing the suit. The use of the BTA will pressurize the affected crewmember to 6 or 8 psi above ambient. Using the BTA to press the suit to 8 psi over ambient renders the suit unusable for subsequent EVA's due to a need for recertification of the suit seals.*

@[101499-7038 ] @[082301-4745 ] @[092607-8602B]

This Rule Continued on Next Page

E. THE STATION PRESSURE WILL REMAIN AT 14.7 PSIA FOR DCS TREATMENT. FOR CUFF CLASS 2, 3, AND 4 SYMPTOMS, THE AFFECTED CREWMEMBER WILL NOT BE EXPOSED TO A REDUCED STATION PRESSURE FOR AT LEAST 72 H AFTER DCS TREATMENT UNLESS REQUIRED FOR EMERGENCY RETURN, CONSUMABLES MANAGEMENT, OR OXYGEN CONSTRAINTS. @[101499-7038 ] @[092607-8602B]

*In all cases, the most effective immediate treatment is repressurization. The total pressure reached at station pressure with the suit in PRESS mode suffices for Cuff Class 2 and 3 symptoms.*

*Due to the severity of Cuff Class 4 symptoms, additional total pressure is desirable. ISS total pressure can only be increased as high as 15.15 psi. The additional treatment resulting from the 0.45 psi increase does not warrant the additional operational complexity required for the pressure increase. Therefore, the ISS treatment does not include a cabin pressure increase above 14.7 psi. The application of the BTA on the EMU will provide increased total pressure.*

*To prevent recurring symptoms, the affected crewmember will not be exposed to station pressure reductions for at least 72 h. Surgeon may require a longer period based on specific symptoms and response to treatment.*

*DOCUMENTATION: NSTS 16007 LCC Rev G (ECL-05), DCS Risk Definition and Contingency Plan Review, April 1998; NASA JSC Decompression Sickness Procedures and Guidelines, JPG 1800.3; OMI V1217 Test Data.*

*Arthur, D.C. and Margulies, R.A. The Pathophysiology, Presentation, and Triage of Altitude-Related Decompression Sickness Associated with Hyperbaric Chamber Operation. Aviat. Space Environ. Med. 48:489-494, May 1982. @[082301-4745 ]*

*Wade Frost presented to the Systems Safety Review Panel, "Review of the Revised On-orbit Bends Treatment Procedure," May 23, 2001.*

*Conkin, J. EVA-IPT response to ACTION about barotrauma risk with rapid decompression of EMU with BTA attached. February 2, 2001.*

*Reference Rule {B17-3}, OXYGEN PARTIAL PRESSURE MANAGEMENT. @[101499-7038 ] @[082301-4745 ] @[062603-6027 ] @[092607-8602B]*

## **Appendix II: ISS Decompression Sickness Treatment Flow**

Note: The ISS DCS treatment flow is necessarily specific to the hardware and resources on the ISS. However, elements of the ISS DCS treatment flow are common to any treatment scenario so that the ISS DCS treatment flow provides a template for future applications. Future exploration-class missions will also have prepared treatment flows, aided in design by the DCS Treatment Model. The treatment model could also be integrated into real-time treatment schemes to add flexibility in treatment paths.

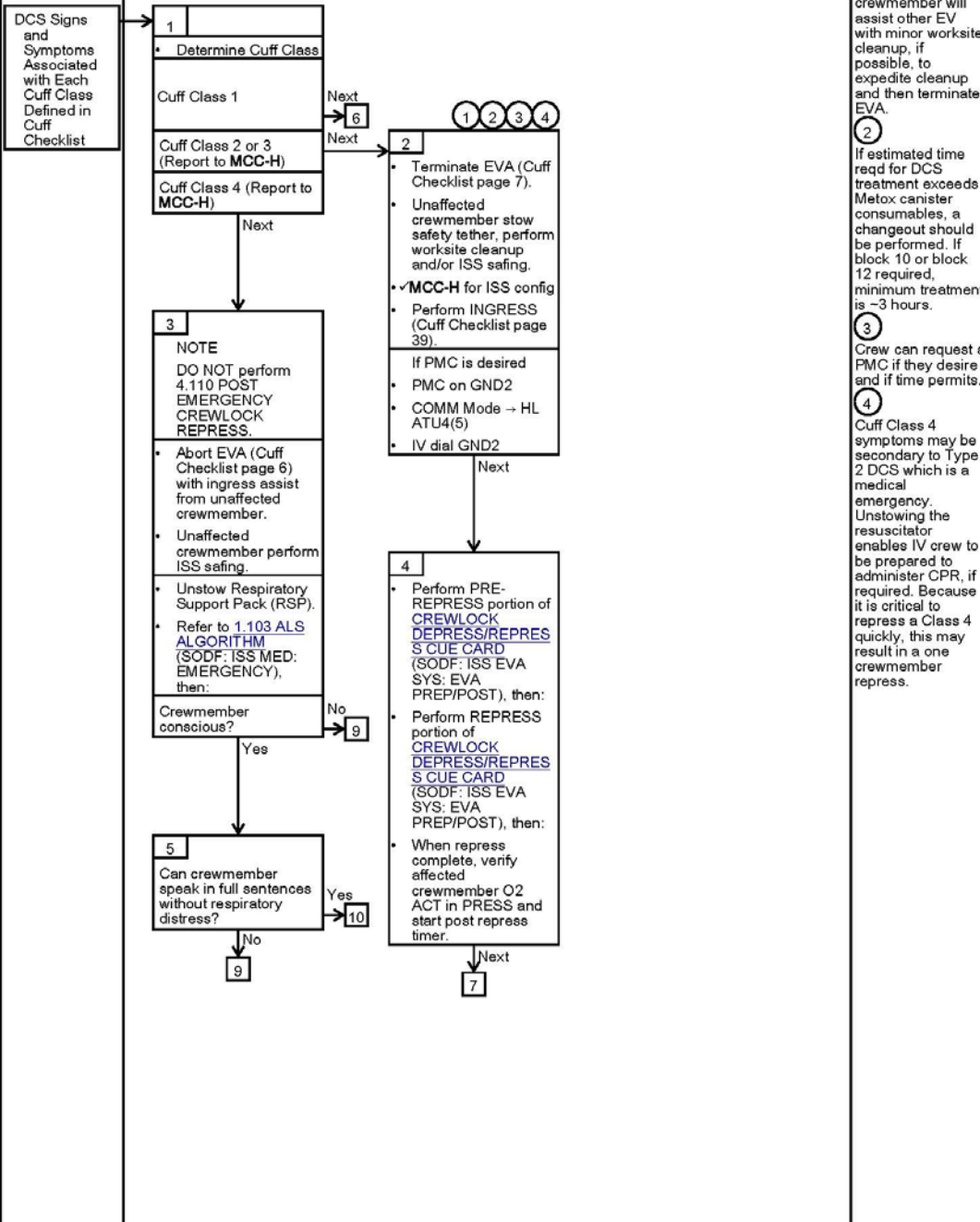

- ① EVA terminated to prevent progression to Cuff Class 4. If Cuff 2, affected crewmember will assist other EV with minor worksite cleanup, if possible, to expedite cleanup and then terminate EVA.
- ② If estimated time reqd for DCS treatment exceeds Metox canister consumables, a changeout should be performed. If block 10 or block 12 required, minimum treatment is ~3 hours.
- ③ Crew can request a PMC if they desire and if time permits.
- ④ Cuff Class 4 symptoms may be secondary to Type 2 DCS which is a medical emergency. Unstowing the resuscitator enables IV crew to be prepared to administer CPR, if required. Because it is critical to repress a Class 4 quickly, this may result in a one crewmember repress.



4.120 DCS TREATMENT

(ISS EVA SYS/E28 - ALL/FIN 10/Paper on ISS)

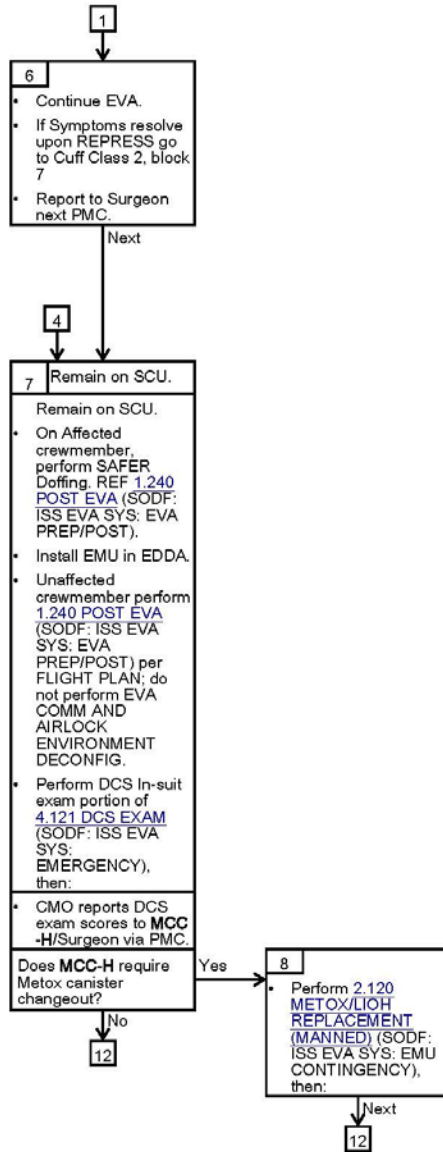

4.120 DCS TREATMENT

(ISS EVA SYS/E28 - ALL/FIN 10/Paper on ISS)

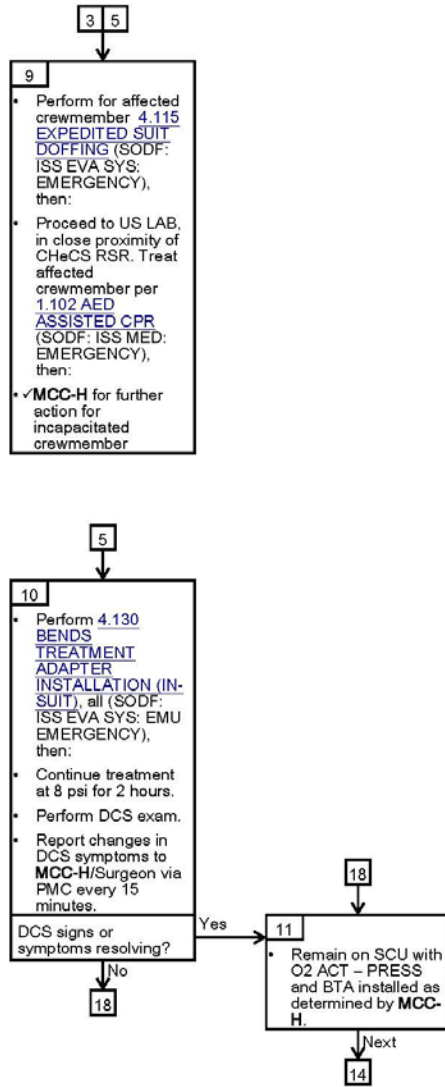

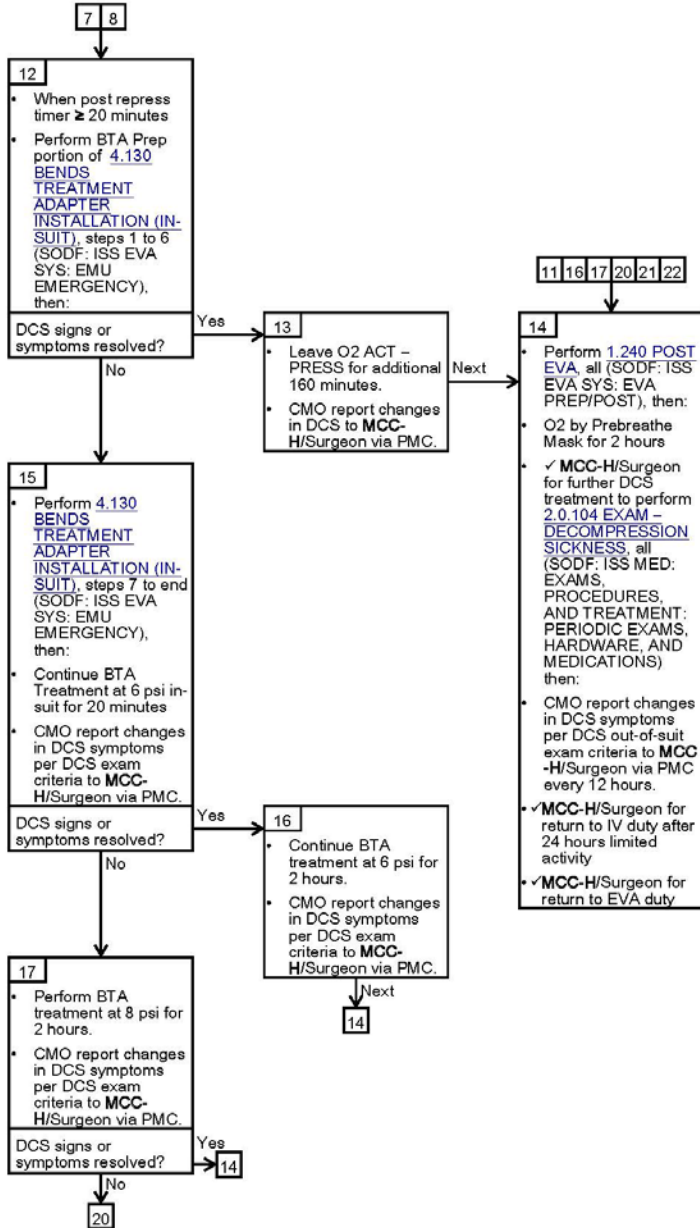

4.120 DCS TREATMENT

(ISS EVA SYS/E28 - ALL/FIN 10/Paper on ISS)

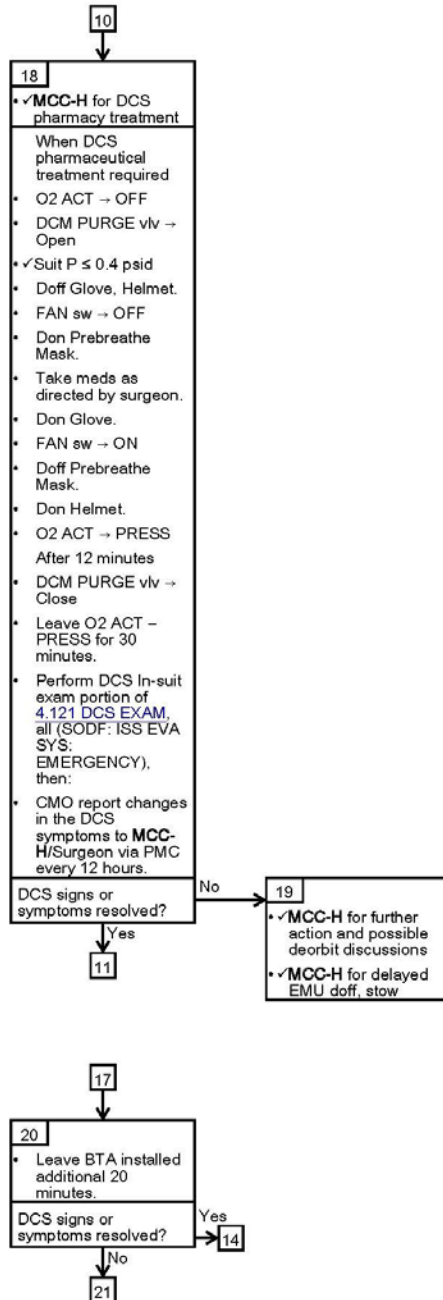

### 4.120 DCS TREATMENT

(ISS EVA SYS/E28 - ALL/FIN 10/Paper on ISS)

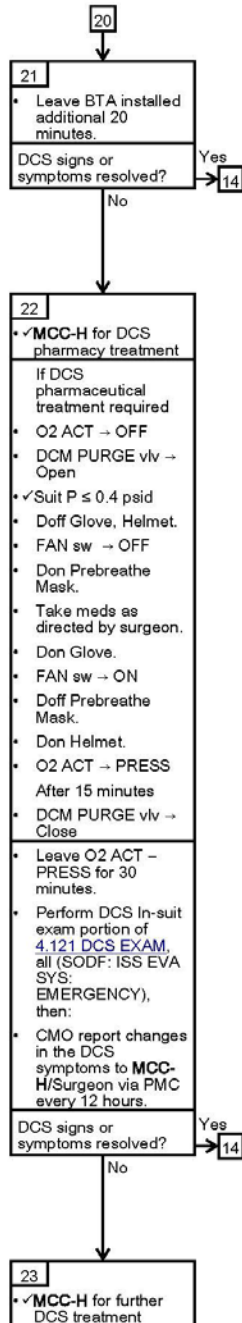

## Appendix III: Decompression Sickness Treatment Database Headings

Note: This database is a quantitative summary of more detailed information contained in 119 case descriptions of DCS, available as Appendix IV.

### Definition of Column Headings

1. ID: Subject identification number. Those with a dash “-“ extension show the number of times a JSC subject participated in a DCS test. Those with letters designate Duke (D), Hermann Hospital (H), or the Defense Research and Development Canada – Toronto (C) as the location of the DCS test. These ID numbers reflect the year of test (first two digits), the month of test (next two digits), and day of test (last two digits). Final letter designates the exercise cot used by the subject, as many as four cots (A, B, C, and D).
2. Depend: Number to indicate “dependence” in these data related to subject ID that identifies multiple symptoms per subject. The same number repeated identifies the same subject with multiple symptoms.
3. Runnumb: A run number discriminator of a different test protocol when DEPEND is otherwise equivalent. For example, a DEPEND number of 21 appears six times. DCS symptoms were reported six times in subject 21 during three different protocols: two symptoms in the first protocol (RUNNUMB = 1), two in a second protocol (RUNNUMB = 2), and two in a third protocol (RUNNUMB = 3). No subject had symptoms reported in four or more protocols. DEPEND and RUNNUMB are details needed to statistically evaluate dependency in the symptom data, else one must assume independence in the symptom data during statistical analysis.
4. Ht: Height in cm
5. Ht1: Height in cm per symptom
6. Wt: Weight in kg
7. Wt1: Weight in kg per symptom
8. BMI: Body Mass Index, computed from  $\text{kg} / \text{meter height}^2$
9. BMI1: Body Mass Index, computed from  $\text{kg} / \text{meter height}^2$  per symptom
10. Age: Age in years
11. Age1: Age in years per symptom
12. Gender: 1=male, 0=female
13. Gender1: Gender per symptom. 1=male, 0=female
14. Bodyloc: Gross anatomical region where a symptom was located. 1=upper-body, 0=lower-body.
15. Ambul: Ambulation before and during altitude exposure. 1=yes, 0=no
16. Ambul1: Ambulation before and during altitude exposure per symptom. 1=yes, 0=no
17. Test: Test identification code indicating a unique test procedure.
18. ALTTIME: Time in h for the duration of the planned exposure.
19. P1: Specific altitude test pressure with psia unit, either 4.3, 6.5, 6.0, or 10.1.
20. TR360: Ratio of computed tissue  $\text{N}_2$  pressure in 360 half-time compartment to  $\text{P}_1$ , or  $\text{P}_B$  for any general ambient pressure, for resting prebreathe condition only. This

- calculation assumes 0 ml/kg/min O<sub>2</sub> consumption, resulting in a 360-min half-time rate constant in denitrogenation equation that contains a  $\lambda$  term.
21. TRCOMBINED: Ratio of computed tissue N<sub>2</sub> pressure in half-time compartment to P1 for resting prebreathe condition (3.5 ml/kg/min) when combined with half-time compartments that varied due to exercise prebreathe in denitrogenation equation that contains a  $\lambda$  term.
  22. Infile: Prebreathe data input file to Tissue Bubble Dynamics Model.
  23. BGI360: Ratio of final computed bubble growth index to initial 3 micron micronuclei radius for the planned elapsed time at P1 – for scheduled end of test so BGI360 also applies to those without DCS. Mass balance and metabolic gas were included along with computed tissue N<sub>2</sub> pressure in 360-min half-time compartment for resting prebreathe condition and when half-time compartment was variable due to exercise prebreathe.
  24. Location: Reported anatomical location of a DCS symptom or in some cases a brief description of a symptom or DCS sign.
  25. Symcount: Numerical sequence of reported symptoms.
  26. Time1...10: Best assessment of elapsed time in minutes from the start of the test at altitude to the recollection or report of a DCS symptom.
  27. BGI1...10: BGI360 associated with time of subsequent reported symptom. The appropriate BGI360 is after elapsed time from the start of test to report of symptom plus the time of ascent.
  28. Scale1...10: A 0 to 10 symptom intensity scale provided by the test subject. When a range of intensity was reported, the mean intensity was used. When intensity was reported as < 1, then 0.9 was used. No entry associated with an elapsed time means that the subject did not report symptom intensity.
  29. Maxinten: Maximum reported symptom intensity. When a range of intensity was reported, the mean intensity was used. When intensity was reported as < 1, then 0.9 was used.
  30. Extp2: Extended time at P1. 1=yes, 0=no. Certain exposures, by design or accident, continued for an extended time after a symptom was reported. Information about the evolution of a symptom is only possible if Extp2 = 1.
  31. Rlfp2: Symptom was completely resolved at the test altitude P1 before repressurization began. 1=yes, 0=no.
  32. Rpstime: Elapsed time in minutes from start of test to start of repressurization from P1.
  33. RpstimeBGI: BGI360 at the time of repressurization – reflects actual time for the subject with a symptom. RpstimeBGI may not equal bgi360 in all cases.
  34. Symdeltm: Difference in time (minutes) at P1 between Rpstime – time1, being the time exposed to the symptom prior to repressurization.
  35. Rlfp3: Symptom was completely resolved during the repressurization interval (about 5 to 15 minutes). 1=yes, 0=no.
  36. Rlfpres3: Pressure in psia unit during repressurization from P1 where symptom resolved or the pressure of the test altitude if symptom resolved at P1 before start of repressurization. Test altitude was either 4.3, 6.5, 6.0, or 10.1 psia in one case.
  37. Rlfpres3BGI: BGI360 at time where symptom resolved during repressurization.
  38. Rlfp4: Symptom was completely resolved at site pressure. 1 = yes, 0 = other.

39. Rlfpres4BGI: BGI360 at time where symptom resolved at site pressure.
40. Rlfpres5BGI: BGI360 at time where symptom resolved during repressurization plus BGI360 at time where symptom resolved at site pressure (Rlfpres3BGI and Rlfpres4BGI).
41. P2: Either Rlfpres3 or site pressure when symptom resolved at site pressure.
42. Deltap: Difference in pressure (mmHg unit, 1 psi = 57.1 mmHg) between Rlfpres3 - P1, and site pressure - P1 when Posttest = 1.
43. Volindex: Computed deltaP from Boyle's law:  $(P1 * 4/3\pi(RPSTIMEBGI*3)^3) / (4/3\pi(RLFPRES5BGI*3)^3) - P1$ , used to confirm that Boyle's law is the dominant factor to decrease BGI during the recompression step. Also can compute the "effective Boyle's law" change by following BGI reabsorption through time, either during GLO period or while breathing air. Computed volindex is close to observed deltap.  $\pi = 3.14159$
44. Glo: Ground-level Oxygen (1 to 2 h) was continued as a treatment for symptoms that resolved at P1, during the repressurization from P1, or at site pressure, and if symptoms were still present at site pressure. 1=yes, 0=no.
45. Posttest: A symptom that resolved before subject was released but later reoccurred is designated with a 1 (9 subjects with 13 symptoms), a symptom that persisted after return to site pressure is designated as a 2 (9 subjects with 20 symptoms), and a 0 indicates no posttest symptom information.
46. Hbo: Hyperbaric Oxygen Treatment, either USN Treatment Table V or VI, that was required to resolve a persistent symptom at site pressure, a recurrent symptom, or even prophylactically when there was no symptom to treat. 1=yes, 0=no.
47. Rlfbho: Symptom was relieved during HBO treatment. 1=yes, 0=no. An indication of 0 means that HBO was provided but there was no symptom to resolve or the symptom did not resolve and was diagnosed as no DCS.
48. Dcstype: Symptom was designated as (1) for Type I pain-only or skin manifestations or (0) for Type II serious. The presence of Cutis Marmorata (CM) by itself or in conjunction with other symptoms was designated as Type II since this was our historical convention. This convention no longer applies when CM appears in isolation from other symptoms. Type I includes joint pain, non-dermatomal pins-and-needles tingling, pruritus (skin itching), hot and cold sensations, urticaria, edema, muscle pain, and muscle spasm, while Type II included fatigue, dizziness, blurred vision, CM, light-headedness, abnormal reflex, cold sweat, cough, headache, dyspnea, hyperesthesia, substernal distress, numbness, nausea, paresthesia associated with dermatomal distribution, and impaired coordination. This list is not all-inclusive and is how symptoms were described in the combined NASA and USAF sources.
49. Loc: Same information as in column labeled "Location".
50. Pain: Symptom attribute where "pain" described symptom.
51. Ache: Symptom described as an ache.
52. Sharp: Symptom described as a sharp or stabbing sensation.
53. Slight: Symptom described as a slight sensation.
54. Mild: Symptom described as a mild sensation.
55. Dull: Symptom described as a dull sensation.
56. Deep: Symptom described as deep in location.
57. Superfsl: Symptom described as superficial in location.



- 58. Discomf: Symptom described as a discomfort, a twinge, cramp, soreness, or even twitching.
- 59. Awareness: Symptom described as an awareness sensation.
- 60. Stiff: Symptom associated with stiffness, an inability to completely extend a limb.
- 61. Full: Symptom described as a fullness sensation.
- 62. Weakness: Affected location felt weak or fatigued, like weakness in a limb.
- 63. Numb: Numbness or cool sensation, associated with poor circulation.
- 64. Other: Symptom other than those attributed to musculoskeletal pain-only, often classified as Type II DCS symptoms.
- 65. Const: Symptom that was constant in nature.
- 66. Throb: Symptom associated with a throbbing sensation.
- 67. Interm: Symptom that was intermittent or transient in nature.

## Appendix IV: Case Descriptions of Hypobaric Decompression Sickness

Note: The following case descriptions are the basis for the NASA Hypobaric Decompression Sickness Treatment Database. Quantitative information extracted from these descriptions allowed the calculation of Bubble Growth Index (BGI) at various times along the symptom history, including BGI at symptom resolution during repressurization. Readers who need these details are directed to our repository for these data (NASA Life Science Data Archive, <http://lsda.jsc.nasa.gov>).

### Bends 1a: DCS Assigned at JSC

**1. Summary:** ID# 21-01, 34-year-old male, maximum Grade 3, first VGE at 46 minutes, first report at 44 minutes, study done on n = 11, independent sample statistical design.

**Procedure 1.** A technical problem with the airlock lid delayed decompression such that total PB time was extended from 3.5 to 4.0 h for this subject, with all else the same as described under Procedure 1 in Appendix V.

**Narrative:** At 44 minutes, subject reported pain on top of right foot. Did not report initial pain score on the 1–10 scale since this scale was not yet implemented. At 118 minutes, he reported pain in right knee in addition to that in right foot. First VGE detected at 46 minutes, Grade 0 from left arm, Grade 0 from left leg, Grade 2 from right arm, and Grade 2 from right leg. Next VGE detected at 62 minutes, Grade 1 in left leg, Grade 1 in right arm and Grade 3 in right leg. Last VGE record at 112 minutes with Grade 0 from left arm, Grade 2 from left leg, Grade 2 from right arm, and Grade 3 from right leg. The MO decided to remove subject from the test, and repressurization began 131 minutes into the test. Symptoms in right foot and right knee resolved during descent at 5.9 psia.

**Diagnosis:** Grade 3 Type I DCS

**Treatment:** None, just observation at the JSC Clinic with follow-up consultation.

**2. Summary:** ID# 25-01, 32-year-old male, maximum Grade 4, first VGE at 27 minutes, first report at 49 minutes, study done on n = 11, independent sample statistical design.

#### Procedure 1

**Narrative:** At 49 minutes, subject reported pain in left foot. Did not report initial pain score on the 1–10 scale since this scale was not yet implemented. At 76 and 116 minutes, subject reported pain in left heel. First VGE detected at 27 minutes, Grade 0 from left arm, Grade 2 from left leg, Grade 3 from right arm, and Grade 2 from right leg. Last VGE record at 109 minutes with Grade 2 from left arm, Grade 4 from left leg, Grade 3 from right arm, and Grade 4 from right leg. The MO decided to remove subject from the test. Subject last reported at 124 minutes that he had continuous pain in left foot and left heel. Symptoms in left foot and left heel resolved during descent at 8.0 psia.

**Diagnosis:** Grade 3 Type I DCS

**Treatment:** None, just observation at the JSC Clinic with follow-up consultation.

**3. Summary:** ID# 26-01, 27-year-old male, maximum Grade 1, first VGE at 59 minutes, first report at 75 minutes, study done on n = 11, independent sample statistical design.

### **Procedure 1**

**Narrative:** At 75 minutes, subject reported pain in left knee. Did not report initial pain score on the 1–10 scale since this scale was not yet implemented. First VGE detected at 59 minutes, Grade 0 from left arm, Grade 1 from left leg, Grade 0 from right arm, and Grade 0 from right leg. Last VGE record at 67 minutes with Grade 0 from left arm, Grade 1 from left leg, Grade 0 from right arm, and Grade 0 from right leg. The MO decided to end the test for this subject. Shortly after this decision was made, the second chamber mate (27-01) reported discomfort in right knee. Recompression of subject began 86 minutes from the start of the test. Symptoms in left knee resolved during descent at 6.0 psia.

**Diagnosis:** Grade 2 Type I DCS

**Treatment:** None, just observation at the JSC Clinic with follow-up consultation.

**4. Summary:** ID# 27-01, 39-year-old male, maximum Grade 2, first VGE at 47 minutes, first report at 76 minutes a symptom he noticed moments earlier, study done on n = 11, independent sample statistical design.

### **Procedure 1**

**Narrative:** At 76 minutes, subject reported discomfort in right knee. Did not report initial pain score on the 1–10 scale since this scale was not yet implemented. Subject noticed discomfort at previous Doppler monitoring station. The exercise protocol was disrupted during the removal of a chamber mate (26-01) at 86 minutes due to pain in left knee. At 102 minutes, the logbook still indicated pain in right leg, specifically the right knee and right ankle. First VGE detected at 47 minutes, Grade 0 from left arm, Grade 0 from left leg, Grade 0 from right arm, and Grade 1 from right leg. Last VGE record at 102 minutes with Grade 0 from left arm, Grade 1 from left leg, Grade 0 from right arm, and Grade 3 from right leg. The MO decided to end the test. Repressurization was started about 102 minutes into the test. Symptoms resolved in right leg during descent at 7.2 psia.

**Diagnosis:** Grade 3 Type I DCS

**Treatment:** None, just observation at the JSC Clinic with follow-up consultation.

### **Bends 1b: DCS Assigned at JSC**

**5. Summary:** ID# 12-01, 29-year-old male, maximum Grade 4, first VGE at 62 minutes, first report at 77 minutes, study done on n = 13, independent sample statistical design.

### **Procedure 2**

**Narrative:** At 77 minutes, subject reported pain in right knee. Did not report initial pain score on the 1–10 scale since this scale was not yet implemented. First VGE detected at 62 minutes, Grade 0 from left arm, Grade 0 from left leg, Grade 0 from right arm, and Grade 3 from right leg. Last VGE record at 79 minutes with Grade 0 from left arm, Grade 0 from left leg, Grade 4 from right arm, and Grade 4 from right leg. The exercise activities were interrupted while his chamber mate was removed for pain symptoms in the knees (11-01). The MO decided to abort this test earlier than the planned after 3 h. Initiated repressurization at 81 minutes. Symptoms in right knee resolved during descent at 5.0 psia.

**Diagnosis:** Grade 3 Type I DCS

**Treatment:** None, just observation at the JSC Clinic with follow-up consultation.

**6. Summary:** ID# 11-01, 45-year-old male, maximum Grade 4, first VGE at 6 minutes, first report at 28 minutes a symptom he noticed earlier, study done on n = 13, independent sample statistical design.

## **Procedure 2**

**Narrative:** At 28 minutes, subject reported pain in right knee and left knee. Did not report initial pain score on the 1–10 scale since this scale was not yet implemented. First VGE detected at 6 minutes, Grade 3 from left arm, Grade 4 from left leg, Grade 4 from right arm, and Grade 4 from right leg. Last VGE record at 23 minutes with Grade 3 from left arm, Grade 4 from left leg, Grade 4 from right arm, and Grade 4 from right leg. The MO decided to remove subject from the test; after 42 minutes, repressurization began. Symptoms resolved during descent in right knee at 5.27 psia and in left knee at 8.69 psia. During debrief, subject mentioned that he felt sensations in the knees long before he reported the symptoms, and that he felt a sharp pain while getting into the airlock for recompression. Pain at that time was a constant deep ache.

**Diagnosis:** Grade 3 Type I DCS

**Treatment:** None, just observation at the JSC Clinic with follow-up consultation.

**7. Summary:** ID# 2-01, 36-year-old male, maximum Grade 3, first VGE at 57 minutes, first report at 64 minutes a symptom he noticed moments earlier, study done on n = 13, independent sample statistical design.

## **Procedure 2**

**Narrative:** At 64 minutes, subject reported pain in left knee. Did not report initial pain score on the 1–10 scale since this scale was not yet implemented. First VGE detected at 57 minutes, Grade 0 from left arm, Grade 3 from left leg, Grade 0 from right arm, and Grade 2 from right leg. This was also the last VGE monitoring period. Since the DT had also reported pain and fullness in the left knee at 44 minutes, the MO terminated the 3-hr test early. Initiated repressurization at 66 minutes. Both subject's and DT's symptoms in left knee resolved during descent at 12.0 psia.

**Diagnosis:** Grade 2 Type I DCS

**Treatment:** None, just observation at the JSC Clinic with follow-up consultation.

## Bends Prevention Test Summary 7/22/82 (from PI)

Decompression to 10.2 psi was completed 7/21/82 at 06:15. 27% O<sub>2</sub> was reached in the ETA and 12 hr period at 10.2 psi was begun. The lock observer began his prebreathe at 03:30 and remained on O<sub>2</sub> until 6:45, a period of 3 h and 15 minutes. At 07:26 the 12 hr period was completed and O<sub>2</sub> breathing was begun. At 8:06 the 40 minutes O<sub>2</sub> breathing was completed. At 08:12 decompression to 4.3 psi was begun. Decompression to 4.3 psi was completed at 08:19. The first exercise cycle began at 08:20 and was completed at 08:34. The DT and both subjects showed no bubbles and no symptoms. Between 08:34 and 08:37 Grade 3 bubbles were detected after movement of the DT's left leg and Grade 1 bubbles were detected after movement of the right leg and right arm. The DT had no symptoms. Between 08:39 and 08:47 both subjects were monitored. No bubbles were detected and no symptoms were reported. At 08:47 to 08:52 the DT was monitored and Grade 3 bubbles were detected after movement of the left leg and Grade 2 bubbles after movement of the right leg. Between 08:54 and 09:03 subjects 1 or 2 were monitored. No bubbles were detected real time and no symptoms were reported. Posttest tape review indicates a possible Grade 1 bubble after movement of subject 2 left leg. Between 09:03 and 09:09 the DT was monitored. Grade 2 bubbles were detected without limb movement. Grade 3 bubbles were detected after movement of the left arm and right leg. Grade 4 bubbles were detected after movement of the left leg and right arm. At 9:07 the DT reported slight transitory pain in the left knee. Between 9:09 and 9:12 subject 1 was monitored and real time Grade 1 was detected after movement of the right leg. Posttest review of the tape indicated this was an artifact, not a bubble. There were no symptoms. The DT was monitored from 9:12 to 9:15. Grade 3 bubbles were detected after movement of the left arm and right leg. Grade 4 bubbles were detected after movement of the left leg and right arm. Symptoms were reported to be about the same as before, but not definite. Between 9:16 and 9:18 subject 2 was monitored and Grade 3 bubbles were detected after movement of the left leg and Grade 2 bubbles after movement of the right leg. Subject had not reported symptoms. At 09:18 to 09:22 the DT was monitored and Grade 3 bubbles were detected without movement. With movement, strong Grade 4 bubbles with heavy showers were measured. The DT then reported fullness in the left knee, like a sprain. Subject 2 then (09:23) reported mild pain in the left knee that had started during his last exercise period (09:16 to 09:18). At 09:25 the decision was made by the MO to terminate the test. At 09:34, at 12 psi, both subject #2 and the DT reported symptoms gone. At 09:36 subject #2 was monitored and no bubbles were detected. At 09:38 the DT was monitored and Grade 3 bubbles were detected after movement of the left leg. At 9:40 the ETA reached 14.7 psi. At 9:51 the DT was monitored again and no bubbles were detected at 09:55. Subject #2 and the DT were taken to the clinic for surveillance.

## Bends 1c: DCS Assigned at JSC

**8. Summary:** ID# 20-01, 34-year-old male, maximum Grade 4, first VGE at 19 minutes, first report at 76 minutes, study done on n = 12, independent sample statistical design.

**Procedure 3.** Same as Procedure 3 except subject spent 4 minutes flexing hip and knee joints by rhythmically stepping in place once every 10 seconds, instead of stepping on an 18.4-cm step once every 10 seconds for 4 minutes.

**Narrative:** At 76 minutes, subject reported discomfort in right knee. Did not report initial pain score on the 1–10 scale since this scale was not yet implemented. First VGE detected at 19 minutes, Grade 0 from left arm, Grade 0 from left leg, Grade 2 from right arm, and Grade 2 from right leg. Last VGE record at 68 minutes with Grade 3 from left arm, Grade 3 from left leg, Grade 4 from right arm, and Grade 4 from right leg. The MO decided to remove subject from the test. At 96 minutes, discomfort in right knee had gone before subject entered the airlock, but returned when he stepped into the airlock and was present prior to repressurization. Symptoms in right knee resolved during descent at 8.30 psia.

**Diagnosis:** Grade 3 Type I DCS

**Treatment:** None, just observation at the JSC Clinic with follow-up consultation.

**9. Summary:** ID# 19-01, 37-year-old male, maximum Grade 4, first VGE at 25 minutes, first report at 78 minutes, study done on n = 12, independent sample statistical design.

### **Procedure 3**

**Narrative:** At 78 minutes, subject reported a short pain in right knee that went away while stepping. Did not report initial pain score on the 1–10 scale since this scale was not yet implemented. At 104 minutes, subject reported slight discomfort in right knee; level remained constant. First VGE detected at 25 minutes, Grade 0 from left arm, Grade 0 from left leg, Grade 3 from right arm, and Grade 0 from right leg. Last VGE record at 109 minutes with Grade 2 from left arm, Grade 4 from left leg, Grade 4 from right arm, and Grade 4 from right leg. At 116 minutes subject, reported intermittent discomfort or low-level pain or awareness in right knee. The MO decided to abort the 3-hr test after 120 minutes of exposure after subject's chamber mate also developed symptoms in right knee (18-01). Symptoms in right knee resolved during descent at 7.3 psia.

**Diagnosis:** Grade 2 Type I DCS

**Treatment:** None, just observation at the JSC Clinic with follow-up consultation.

**10. Summary:** ID# 18-01, 33-year-old male, maximum Grade 4, first VGE at 69 minutes, first report at 104 minutes, study done on n = 12, independent sample statistical design.

### **Procedure 3**

**Narrative:** At 104 minutes, subject reported slight discomfort in right knee. At 116 minutes, he reported intermittent discomfort or low-level pain awareness in right knee. Did not report initial pain score on the 1–10 scale since this scale was not yet implemented. Grade 4 VGE were detected 87 minutes into the test after flexing right leg, and again at 101 minutes when right leg or left leg was flexed. First VGE detected at 69 minutes, Grade 0 from left arm, Grade 0 from left leg, Grade 0 from right arm, and Grade 1 from right leg. Last VGE record at 101 minutes with Grade 1 from left arm, Grade 2 from left leg, Grade 4 from right arm, and Grade 4 from right leg. The MO decided to abort the 3-hr test after 120 minutes of exposure after subject's chamber mate also developed symptoms in right knee (19-01). Symptoms in right knee resolved during descent at 7.3 psia.

**Diagnosis:** Grade 2 Type I DCS

**Treatment:** None, just observation at the JSC Clinic with follow-up consultation.

**11. Summary:** ID# 15-01, 28-year-old male, maximum Grade 4, first VGE at 37 minutes, first report after the end of the test during debrief, estimated at 166 minutes into the test, study done on n = 12, independent sample statistical design.

### Procedure 3

**Narrative:** During debrief, subject mentioned that he felt some pain during the last round of exercise at about 166 minutes in his right ankle, and that there was a sharp pain below both knee caps just prior to descent. Did not report initial pain score on the 1–10 scale since this scale was not yet implemented. First VGE detected at 37 minutes, Grade 0 from left arm, Grade 0 from left leg, Grade 0 from right arm, and Grade 1 from right leg. Last VGE record at 181 minutes with Grade 0 from left arm, Grade 3 from left leg, Grade 2 from right arm, and Grade 3 from right leg. Symptoms in both knees and right ankle resolved during descent at 12.2 psia, as estimated from the posttest comments.

**Diagnosis:** Grade 2 Type I DCS

**Treatment:** None, just self-monitoring most likely with follow-up consultation.

### Bends 1d: DCS Assigned at JSC

**12. Summary:** ID# 11-02, 45-year-old male, maximum Grade 4, first VGE at 34 minutes, first report after the end of the test during debrief, estimated at 50 minutes into the test, study done on n = 3, independent sample statistical design.

### Procedure 4

**Narrative:** During debrief, subject mentioned that after 3<sup>rd</sup> or 4<sup>th</sup> exercise period he felt something in his knees. This would have been about 50 minutes into the test. Did not report initial pain score on the 1–10 scale since this scale was not yet implemented. He said that the sensations in his knees did go away on return to site pressure. He compared symptoms in left and right shins, and intermittent pain in the knees as a different type of pain to that he had experienced on a previous exposure (11-01), 2 days earlier. It was a much milder pain than before. First VGE detected at 34 minutes, Grade 1 from left arm, Grade 3 from left leg, Grade 0 from right arm, and Grade 3 from right leg. Last VGE record at 177 minutes with Grade 3 from left arm, Grade 4 from left leg, Grade 4 from right arm, and Grade 4 from right leg. Symptoms in both knees and shins resolved during descent at site pressure, as revealed during debriefing.

**Diagnosis:** Grade 2 Type I DCS

**Treatment:** None, just self-monitoring most likely with follow-up consultation.

**13. Summary:** ID# 10-02, 44-year-old male, maximum Grade 4, first VGE at 62 minutes, first report after the end of the test during debrief, estimated at 60 minutes into the test, study done on n = 3, independent sample statistical design.

### Procedure 4

**Narrative:** During debrief, subject mentioned that after about 60 minutes into the test he experienced a symptom in right leg. Symptom was clear during the last hr of the 3-hr test. Did not report initial pain score on the 1–10 scale since this scale was not yet implemented. First VGE detected at 62 minutes, Grade 0 from left arm, Grade 1 from left leg, Grade 1 from right

arm, and Grade 2 from right leg. Last VGE record at 174 minutes with Grade 0 from left arm, Grade 1 from left leg, Grade 3 from right arm, and Grade 4 from right leg. There were no symptoms prior to descent; symptoms resolved at the test altitude of 4.3 psia.

**Diagnosis:** Grade 2 Type I DCS

**Treatment:** None, self-monitoring most likely with follow-up consultation.

## **Bends 2a: DCS Assigned at JSC**

**14. Summary:** ID# 37-02, 26-year-old male, maximum Grade 4, first VGE at 55 minutes, first report at 59 minutes, study done on n = 23, independent sample statistical design.

### **Procedure 5**

**Narrative:** At 59 minutes, subject reported momentary pain in right knee; pain was gone at 1<sup>st</sup>-hr questioning. Reported initial pain score of 1 on a 1–10 scale. At 106 minutes, subject reported an occasional twinge in right knee. At 218 minutes, subject reported continuing twinges in right knee; level remained constant at 1. The exercise protocol was briefly interrupted as his chamber mate (21-02) was returned to site pressure at 177 minutes for pain in left knee and left ankle. First VGE detected at 55 minutes, Grade 0 from left arm, Grade 3 from left leg, Grade 0 from right arm, and Grade 3 from right leg. Last VGE record at 176 minutes with Grade 0 from left arm, Grade 0 from left leg, Grade 0 from right arm, and Grade 4 from right leg. The 4-hr test was completed. Logbook indicated that subject was clear of symptoms in right knee on the way to site pressure. During debrief, subject indicated mild right knee pain for most of the test and an itch on right thigh for about half an hr during test. Pain diminished with descent, but rash mark still remained at location of itch. Subject mentioned that there was still very slight discomfort in right knee.

**Diagnosis:** Grade 2 Type I DCS, CM cannot be ruled out

**Treatment:** None, medical observation provided for 12 h with follow-up consultation.

**15. Summary:** ID# 35-02, 43-year-old male, maximum Grade 4, first VGE at 116 minutes, first report at 116 minutes a symptom he noticed moments earlier, study done on n = 23, independent sample statistical design.

### **Procedure 5**

**Narrative:** At 116 minutes, subject reported pain in arch of right foot. Reported initial pain score of 4 on a 1–10 scale. He noticed symptom earlier, just before going to the Doppler monitoring station. At 177 minutes, the level decreased to 3–4; and by 243 minutes, subject reported pain in both knees, the level had decreased to 2. His chamber mate (38-03) reported discomfort in left knee at 221 minutes. First VGE detected at 116 minutes, Grade 0 from left arm, Grade 0 from left leg, Grade 0 from right arm, and Grade 2 from right leg. Last VGE record at 196 minutes with Grade 0 from left arm, Grade 0 from left leg, Grade 3 from right arm, and Grade 4 from right leg. Symptoms in both knees, arch of right foot, and right ankle resolved during descent at 8.81 psia. During debrief, subject mentioned that pain in arch of right foot moved



up into right ankle, and it felt like a strain in the joint. He favored right knee at first, but was able to do the assigned exercise. Pain then spread to right knee. Intensity of the pain decreased with time. It was mentioned that pain in the knee (or knees) decreased when he was in the reclined position, and decreased when he bent his knee (or knees).

**Diagnosis:** Grade 2 Type I DCS

**Treatment:** None, medical observation provided most likely for 12 h with follow-up consultation.

**16. Summary:** ID# 21-02, 34-year-old male, maximum Grade 4, first VGE at 105 minutes, first report at 76 minutes, study done on  $n = 23$ , independent sample statistical design.

### **Procedure 5**

**Narrative:** At 76 minutes, subject reported pain in left ankle. Reported initial pain score of 1 on a 1–10 scale. At 117 minutes, subject reports dull ache in left knee; level remained constant at 1, but increased to a pain score of 7 at 148 minutes with pain reported in left knee and left ankle, with pain blending together. His chamber mate (37-02) had reported a momentary pain in right knee at 59 minutes. First VGE detected at 105 minutes, Grade 0 from left arm, Grade 4 from left leg, Grade 0 from right arm, and Grade 3 from right leg. Last VGE record at 122 minutes with Grade 0 from left arm, Grade 3 from left leg, Grade 0 from right arm, and Grade 2 from right leg. The MO decided to remove subject from the test. At 166 minutes, subject reported continuous pain in left knee and left ankle, but pain score had reduced to 3. Repressurization was started 177 minutes into the 4-hr test. Symptoms in left ankle and left knee resolved during descent at 7.1 psia.

**Diagnosis:** Grade 3 Type I DCS

**Treatment:** None, medical observation provided for 12 h with follow-up consultation.

**17. Summary:** ID# 34-01, 30-year-old male, maximum Grade 4, first VGE at 77 minutes, first report of a symptom was after the test, and estimated to be 42 minutes into the test, study done on  $n = 23$ , independent sample statistical design.

**Procedure 5.** Same as Procedure 5 except the PB was extended by 10 minutes because a lock valve was open and interfered with nominal ETA pump down.

**Narrative:** Subject did not report symptoms during test. During debrief, subject mentioned a dull pain in right knee at about 42 minutes, also a twinge in left knee for which no time was documented. Subject did not report initial pain score on the 1–10 scale. At 119 minutes, pain score increased to 5; and by 228 minutes, pain score decreased to 2, for right knee. At 139 minutes, subject had Grade 4 VGE during all limb movements. First VGE detected at 77 minutes, Grade 0 from left arm, Grade 0 from left leg, Grade 2 from right arm, and Grade 0 from right leg. Last VGE record at 218 minutes with Grade 0 from left arm, Grade 3 from left leg, Grade 1 from right arm, and Grade 2 from right leg. Prior to return to site pressure, at 4 h he still had symptoms in left knee and right knee because he said pain had resolved during return to site pressure. Symptoms in both knees resolved at 7.34 psia during descent, based on debrief

estimate. It is unclear from the logbook if subject still had awareness in both knees at site pressure. Within 2 h of the conclusion of test, subject reported pain in both knees.

**Diagnosis:** Grade 2 Type I DCS

**Treatment:** USN HBO TT V for reoccurrence of symptoms. Pain was relieved on the compression. Medical observation provided for 12 h with follow-up consultation.

**18. Summary:** ID# 5-02, 29-year-old male, maximum Grade 4, first VGE at 104 minutes, first report at 160 minutes, study done on n = 23, independent sample statistical design.

### **Procedure 5**

**Narrative:** At 160 minutes, subject reported some pain and discomfort in right knee and right foot. Reported initial pain score of 7 on a 1–10 scale. He described pain in right foot as a muscle cramp, and pain in right knee as sharp when standing. Right knee pain was localized outside the joint. It went to a pain score of 2 when standing on the floor at rest, but increased to a 7 when walking from station to station. At 177 minutes, level remained constant at 7; and at 223 minutes, level was still constant at 7. First VGE detected at 104 minutes, Grade 0 from left arm, Grade 0 from left leg, Grade 0 from right arm, and Grade 2 from right leg. Last VGE record at 222 minutes with Grade 0 from left arm, Grade 0 from left leg, Grade 0 from right arm, and Grade 4 from right leg. Symptoms in right knee and right foot resolved during descent at 9.35 psia. During debrief, it appeared that subject had a tendency to favor right knee, but this did not interfere with his exercise activities. Pain in right foot was localized in the arch or instep, where he sometimes gets cramps.

**Diagnosis:** Grade 2 Type I DCS

**Treatment:** None, medical observation provided most likely for 12 h with follow-up consultation.

**19. Summary:** ID# 32-01, 29-year-old male, maximum Grade 4, first VGE at 18 minutes, first report at debrief, but no indication of when during the test the symptoms first appeared, study done on n = 23, independent sample statistical design.

### **Procedure 5**

**Narrative:** Subject did not report symptoms during test. During debrief, subject indicated very mild pain, more like stiffness in right knee and right foot, but no time was documented. Did not report initial pain score on the 1–10 scale. He mentioned that there was no pain at all during 4<sup>th</sup>-hr questioning, but that stiffness (unclear if this is for right knee, right foot, or both) went away on recompression to site pressure. This was his first indication that his symptoms might be related to decompression to 4.3 psia. First VGE detected at 18 minutes, Grade 0 from left arm, Grade 0 from left leg, Grade 0 from right arm, and Grade 3 from right leg. Last VGE record at 230 minutes with Grade 0 from left arm, Grade 0 from left leg, Grade 0 from right arm, and Grade 3 from right leg. Symptoms resolved during descent, but exact altitude was not noted. Symptoms from right foot and right knee were gone at site pressure.

**Diagnosis:** Grade 1 Type I DCS

**Treatment:** Not clear if HBO was provided in this case, but there would be a follow-up consultation.

**20. Summary:** ID# 38-03, 33-year-old male, maximum Grade 3, first VGE at 216 minutes, first report at 221 minutes, study done on n = 23, independent sample statistical design.

### **Procedure 5**

**Narrative:** At 221 minutes, subject reported discomfort, but not pain, in left knee along the lateral aspect. Reported initial pain score of less than 1 on a 1–10 scale. At 243 minutes, subject reported that pain scale was 1. His chamber mate (35-02) reported a pain in arch of the right foot at 116 minutes. First VGE detected at 216 minutes, Grade 0 from left arm, Grade 3 from left leg, Grade 1 from right arm, and Grade 0 from right leg. Last VGE record at 232 minutes with Grade 0 from left arm, Grade 3 from left leg, Grade 0 from right arm, and Grade 0 from right leg. There were no symptoms prior to descent; symptoms resolved at the test altitude of 4.3 psia. During debrief, subject mentioned that symptom in left knee was an awareness.

**Diagnosis:** Grade 1 Type I DCS

**Treatment:** None, just self-monitoring most likely with follow-up consultation.

### **Bends 2b: DCS Assigned at JSC**

**21. Summary:** ID# 35-03, 43-year-old male, maximum Grade 4, first VGE at 34 minutes, first report at 17 minutes, study done on n = 22, independent sample statistical design.

### **Procedure 6**

**Narrative:** At 17 minutes, subject reported deep pain in left knee. Reported initial pain score of 7 on a 1–10 scale. He reported that this symptom was similar to one he experienced in right foot and right knee on a previous test (35-02) where symptoms were present at about 116 minutes. At 34 minutes and 60 minutes, level remained constant at 7, but did not interfere with his activities. Pain score intensity decreased to 3 at 81 minutes and 110 minutes. During 3<sup>rd</sup>-hr questioning, subject reported that pain score increased to 6–7, left leg seemed weaker, and pain occupied the entire left knee. At 201 minutes, subject reported again that left leg seemed to be getting weak, on a pain scale of 9, but felt he could get through the last hr. At 4<sup>th</sup>-hr questioning, subject reported there was no change in left knee symptoms from the last report; a pain score of 9 at 240 minutes. First VGE detected at 34 minutes, Grade 0 from left arm, Grade 4 from left leg, Grade 1 from right arm, and Grade 2 from right leg. Last VGE record at 228 minutes with Grade 0 from left arm, Grade 0 from left leg, Grade 0 from right arm, and Grade 0 from right leg. Symptoms improved during descent but did not clear completely at site pressure. During debrief, subject mentioned that left knee was not hurting, and strength had returned to left leg. Pain score was about 1 initially at site pressure; 16 minutes after the start of repressurization to site pressure, all symptoms were gone. He said that lying down made pain in his left knee worse to the point where he sat up during any rest period and after Doppler monitoring. During the greatest

discomfort, at a pain score of 9, he had trouble walking. Finally, pain in left knee noticeably lessened at about 10.5 psia.

**Diagnosis:** Grade 3 Type I DCS

**Treatment:** None, medical observation provided most likely for 12 h with follow-up consultation.

**22. Summary:** ID# 34-02, 31-year-old male, maximum Grade 4, first VGE at 69 minutes, first report at 236 minutes a symptom he noticed at 206 minutes, study done on n = 22, independent sample statistical design.

### Procedure 6

**Narrative:** At 236 minutes, subject reported minor aches and pains in right knee and left knee, with right knee symptoms more noticeable. Reported initial pain score of 2 on a 1–10 scale. Symptoms had started about 30 minutes earlier (206 minutes) and were localized beneath the patella of both knees. His chamber mate (31-03) had reported symptoms in right arm at 180 minutes. First VGE detected at 69 minutes, Grade 0 from left arm, Grade 3 from left leg, Grade 1 from right arm, and Grade 2 from right leg. Last VGE record at 233 minutes with Grade 3 from left arm, Grade 4 from left leg, Grade 4 from right arm, and Grade 4 from right leg. Logbook did not indicate if symptoms in both knees improved during repressurization to site pressure. During debrief, subject mentioned that his knees felt better, but there was still some residual awareness like what you would experience after a good run. Subject had a previous chamber test (34-01) where symptoms were present but reported after the test. Debrief notes for this test indicated he had a reoccurrence of symptoms in his knees and was treated 1.0–1.5 h after debrief.

**Diagnosis:** Grade 2 Type I DCS

**Treatment:** USN HBO TT V for reoccurrence of symptoms. Symptoms disappeared at the 60-foot level on treatment, plus a follow-up consultation. *Note: It is unclear from the available information if persistent symptoms in the knees at site pressure were the reason for the HBO treatment or if a reoccurrence of symptoms after the subject was released from the test prompted the HBO treatment. There is an indication that that the symptoms had finally resolved at site pressure. For purposes of post-test analysis the symptoms are classified as having cleared at site pressure to an extent that the subject was released from the test, but that within 1.0-1.5 h after the debrief the symptoms reoccurred to such an extent to prompt an HBO treatment (08/22/13).*

**23. Summary:** ID# 31-03, 31-year-old male, maximum Grade 1, first VGE at 144 minutes, first report at 180 minutes, study done on n = 22, independent sample statistical design.

### Procedure 6

**Narrative:** At 180 minutes, subject reported right arm felt different than left arm, meaning symptom was in right arm. Reported initial pain score of 1 on a 1–10 scale, as determined from debrief comments. At 207 and 236 minutes, level remained constant at 1. His chamber mate (34-02) had reported symptoms in right knee and left knee at 236 minutes. First VGE detected at 144

minutes, Grade 0 from left arm, Grade 1 from left leg, Grade 0 from right arm, and Grade 0 from right leg. Last VGE record at 236 minutes with Grade 0 from left arm, Grade 0 from left leg, Grade 0 from right arm, and Grade 0 from right leg. During 4<sup>th</sup>-hr questioning, subject mentioned that he had a cramp in left foot, but attributed problem to his shoes; cramp was improved when he took his shoes off. Symptoms in right arm resolved during descent at 5.45 psia. During debrief, there was some question if symptom in right arm had gone before the re-pressurization, or if it cleared on the way to 25,000 feet (5.45 psia). Location of symptom was in forearm of right arm, and was not exercise related in that the feeling was not exacerbated during arm exercise and the symptoms were very intermittent.

**Diagnosis:** Grade 1 Type I DCS

**Treatment:** None, medical observation provided most likely for 12 h with follow-up consultation.

**24. Summary:** ID# 3-03, 29-year-old male, maximum Grade 4, first VGE at 76 minutes, first report at 175 minutes, study done on n = 22, independent sample statistical design.

### **Procedure 6**

**Narrative:** At 175 minutes, subject reported no aches or pains, but felt a heaviness in his legs, like blood pooling. Reported initial pain score of 1 on a 1–10 scale. At 209 minutes, he was more specific in that lower right leg felt like it had poor circulation; no particular area hurt. Assigned a pain score of 2 to right heel; classified symptom as an awareness. Massaging right leg and right foot seemed to make them feel better. Right heel and top front of right shin had diffuse sensations. Right knee was also reported to have an awareness or fullness, like poor circulation, at this time. At 4<sup>th</sup>-hr questioning, subject reported the same numbness, toes cold like you experience with lack of circulation. Still had an awareness of symptoms that were accentuated by right leg movements. He assigned pain score of 2 for his symptoms at 241 minutes. First VGE detected at 76 minutes, Grade 0 from left arm, Grade 0 from left leg, Grade 1 from right arm, and Grade 2 from right leg. Last VGE record at 236 minutes with Grade 1 from left arm, Grade 2 from left leg, Grade 2 from right arm, and Grade 4 from right leg. Symptoms of cold right foot and numbness resolved during descent at approximately 6.75 psia. During debrief, subject mentioned that symptoms during this test were like symptoms on his first 10.2-psia test (test designation 1b, 3-01), but no DCS was diagnosed during that test. This was 3<sup>rd</sup> time subject had participated in a chamber test, and the 1<sup>st</sup> time he reported symptoms. He mentioned that ball of right foot had cramped. Symptoms were described as diffuse, moving around right leg. Also mentioned that he was fatigued toward the end of the test.

**Diagnosis:** Grade 1 Type I DCS

**Treatment:** None, medical observation provided most likely for 12 h with follow-up consultation.

**25. Summary:** ID# 21-03, 34-year-old male, maximum Grade 4, first VGE at 37 minutes, first report at 160 minutes, study done on n = 22, independent sample statistical design.

## Procedure 6

**Narrative:** At 160 minutes, subject reported pain, ache, and some stabbing in left shoulder. Reported initial pain score of 2 on a 1–10 scale. For completeness, he also reported a slight ache in one of his teeth when the test at 4.3 psia first began. At 3<sup>rd</sup>-hr questioning, he said pain in left shoulder was gone, but was at a pain score of 1 on the last exercise activity. At about 210 minutes, subject reported a stabbing type of pain had appeared in left ankle during last exercise activity; gave this a pain score of 2 at about 201 minutes. Pain in left ankle had decreased to a pain score of 1–2 at 239 minutes. First VGE detected at 37 minutes, Grade 3 from left arm, Grade 0 from left leg, Grade 0 from right arm, and Grade 0 from right leg. Last VGE record at 240 minutes with Grade 3 from left arm, Grade 3 from left leg, Grade 0 from right arm, and Grade 0 from right leg. Symptoms in left ankle resolved during descent at 5.45 psia. Subject had 2 previous tests (21-01 and 21-02) where symptoms were present.

**Diagnosis:** Grade 2 Type I DCS

**Treatment:** None, medical observation provided most likely for 12 h with follow-up consultation.

**26. Summary:** ID# 18-02, 33-year-old male, maximum Grade 4, first VGE at 1 minutes, first report at 65 minutes, study done on n = 22, independent sample statistical design.

## Procedure 6

**Narrative:** At 65 minutes, subject reported discomfort and pain in right knee. Reported initial pain score of 1 on a 1–10 scale. At 103 minutes, level increased to 2–3. Grade 1 VGE were detected 1 minute into the test after flexing right leg. Grade 4 VGE were detected at 17 minutes after flexing right leg. Grade 4 VGE were detected from all limbs at 52 minutes and at 92 minutes. Subject in a previous test (18-01) reported discomfort in right knee at 104 minutes. Last VGE record at 92 minutes with Grade 4 from left arm, Grade 4 from left leg, Grade 4 from right arm, and Grade 4 from right leg. At 103 minutes, subject reported sudden onset of fatigue and cold sweat. At the same time, red and white mottling or marbling appeared on chest. Skin mottling was diagnosed 103 minutes into the exposure. Accumulation and rapid onset of signs and symptoms initiated removal of subject through a smaller transfer airlock at 115 minutes. Pain in right knee and feeling of fatigue cleared at 7.2 psia. Mottling disappeared in 10 minutes at site pressure on 100% O<sub>2</sub>. During debrief, subject mentioned that fatigue was very significant and he felt it would interfere with his ability to perform the exercise protocol.

**Diagnosis:** Type II DCS (at this time, CM by itself was also classified as Type II DCS at JSC)

**Treatment:** Two-hr GLO. Subject was held in a horizontal position while on 100% O<sub>2</sub> for 2 h and was under medical observation in a hyperbaric chamber overnight. There were no further symptoms or indication of neurological deficit during follow-up consultation.

A 33-year-old male, 62.6 kg, 167 cm, with 15% computed body fat and 22.4 BMI [body mass index], participated in an altitude exposure at JSC. Subject had one previous altitude exposure as a research subject to evaluate the effectiveness of a staged decompression protocol to prevent DCS during extravehicular activity from the Space Shuttle. A brief description of the first test is warranted. Subject ascended to 10.2 psia in about 2 minutes, and the chamber atmosphere was enriched to 26.5% O<sub>2</sub>. There was minimal physical activity, including sleep, during the

12 hr exposure. A 90 minutes O<sub>2</sub> PB with a 4 minutes ascent preceded a 3 hr exposure to 4.3 psia. Exercise stressed the lower body since 4 minutes were spent flexing the ankle, knee, and hip joints by rhythmically stepping onto an 18.4-cm step once every 10 seconds. This was followed by 4 minutes of flexing the wrist, elbow, and shoulder joints by rhythmically lifting a 1.36 kg weight alternately every 5 seconds from left to right hand. Finally, there was a 4 minutes period of rest and a 4 minutes period of bubble monitoring with subject asked to flex each limb in turn while in a supine position. Bubble monitoring was provided by a DT trained to detect the blood flow signal in the pulmonary artery, at the precordial position, using an ultrasound Doppler bubble detector. Subject ambulated to the 2 exercise stations within the chamber. Grade IV VGE were detected 87 minutes into the test after flexing the right leg, and again at 101 minutes when the right or left leg was flexed. Subject reported pain in the right knee at 116 minutes, and the test was aborted at 118 minutes for an unrelated reason. The pain in the right knee cleared at 7.3 psia during the repressurization to site pressure. Several changes were made to the staged decompression protocol, and subject was willing to participate again. Five months later subject again ascended to 10.2 psia in about 5 minutes, and the chamber atmosphere was once again enriched to 26.5% O<sub>2</sub>. There was minimal physical activity, including sleep, during the 12 hr exposure. A 40 minutes O<sub>2</sub> PB with a 25 minutes ascent preceded a 4 hr exposure to 4.3 psia. Exercise stressed the upper body since 4 minutes were spent flexing the wrist, elbow, and shoulder joints while rhythmically rotating the wheel of a bicycle ergometer against a set resistance from a standing position, 4 minutes torquing fixed bolts with either the left or right hand from a standing position, and 4 minutes of rhythmically pulling against a set resistance from a seated position. Additional details about the exercises are available. Finally, there was a 4 minutes period of rest and a 4 minutes period of bubble monitoring with the subject asked to flex each limb in turn while in a supine position. Subject ambulated to the three exercise stations within the chamber. Grade I VGE were detected 1 minutes into the test after flexing the right leg. Grade IV VGE were detected at 17 minutes after flexing the right leg. Grade IV VGE were detected from all limbs at 52 minutes and at 92 minutes. Subject reported pain in the right knee after 57 minutes. At 103 minutes subject reported sudden onset of fatigue, and cold sweat. At the same time, red and white mottling or marbling appeared on the chest. Skin mottling was diagnosed 103 minutes into the exposure. The accumulation and rapid onset of signs and symptoms initiated the removal of subject through a smaller transfer airlock at 115 minutes. Pain and feeling of fatigue cleared at 7.2 psia. Mottling disappeared in 10 minutes at site pressure on 100% O<sub>2</sub>. Subject was held in a horizontal position while on 100% O<sub>2</sub> for 2 hr and was under medical observation in a hyperbaric chamber overnight. There were no further symptoms or indication of neurological deficit.

## **Bends 3a: DCS Assigned at JSC**

**27. Summary:** ID# 42-02, 28-year-old male, maximum Grade 4, first VGE at 34 minutes, first report at 356 minutes a symptom he first noticed at about 294 minutes, study done on n = 28, independent sample statistical design.

### **Procedure 7**

**Narrative:** At 356 minutes, during 6<sup>th</sup>-hr questioning, subject reported minor ache in right knee. Reported initial pain score of 4 on a 1–10 scale that went to a pain score of 2, but this was for symptom he experienced earlier in the test. Symptom was present on the cot at the Doppler monitoring station. He noticed this symptom about 2.5 exercise rotations earlier, or at about 294 minutes. His chamber mate (44-02) had reported symptom at 68 minutes of very mild discomfort in the right knee. First VGE detected at 34 minutes, Grade 0 from left arm, Grade 0 from left leg, Grade 0 from right arm, and Grade 3 from right leg. Last VGE record at 356 minutes with Grade 1 from left arm, Grade 0 from left leg, Grade 2 from right arm, and Grade 2 from right leg. At continuation of 6<sup>th</sup>-hr questioning, subject reported ache in right knee was not present at that time. There were no symptoms prior to descent; symptoms resolved at the test altitude of 4.3 psia. During debrief at site pressure, subject mentioned pain in right knee was continuous for about 20 minutes; initially a sharp clear pain for about 30 seconds, then went from a pain score of 4–5 to about 1–2, and was worse when standing and exercising at the arm ergometer.

**Diagnosis:** Grade 2 Type I DCS

**Treatment:** None, medical observation provided most likely for 12 h with follow-up consultation.

**28. Summary:** ID# 47-01, 26-year-old male, maximum Grade 4, first VGE at 4 minutes, first report at 60 minutes a symptom he noticed at 50 minutes, study done on n = 28, independent sample statistical design.

### **Procedure 7**

**Narrative:** At 60 minutes, during 1<sup>st</sup>-hr questioning, subject reported pain that came and went in left knee and was worse when lying down. Reported initial pain score of 4 on a 1–10 scale. He recalled that symptom was noticed about 10 minutes earlier, and did not interfere with his exercise activities. Pain score remained constant at 4 during 2<sup>nd</sup>-hr questioning, and again a pain score of 4 at 179 minutes. During 3<sup>rd</sup>-hr questioning, pain was described as intermittent and noticed in left knee while he was lying down with movement of the limb and ankle during the Doppler monitoring. At 4<sup>th</sup>-hr questioning, subject reported no change in left knee pain, but now both ankles had a continuous pain; no pain score was given for ankles. Left knee had a pain score of 1 at this time. At 5<sup>th</sup>-hr questioning, subject reported no further pain in left knee, just a bit of mild continuous stiffness in ankles. At 6<sup>th</sup>-hr questioning, pain in ankles was still present. First VGE detected at 4 minutes, Grade 0 from left arm, Grade 4 from left leg, Grade 0 from right arm, and Grade 2 from right leg. Last VGE record at 355 minutes with Grade 0 from left arm, Grade 0 from left leg, Grade 0 from right arm, and Grade 2 from right leg. Symptoms in ankles resolved during descent at 6.33 psia on the way to site pressure.

**Diagnosis:** Grade 2 Type I DCS

**Treatment:** None, medical observation provided most likely for 12 h with follow-up consultation.

**29. Summary:** ID# 46-01, 50-year-old male, maximum Grade 4, first VGE at 76 minutes, first report at 303 minutes a symptom he noticed at 120 minutes, study done on n = 28, independent sample statistical design.

### **Procedure 7**

**Narrative:** At 303 minutes, during 5<sup>th</sup>-hr questioning, subject reported a little bit of pain in right knee. Reported initial pain score of 1–2 on a 1–10 scale. He first felt something in right knee at about 120 minutes, but feeling went away. It was back now and was continuous, but got better when he walked. His chamber mate (13-04) had reported symptom in the left knee at 205 minutes. First VGE detected at 76 minutes, Grade 2 from left arm, Grade 0 from left leg, Grade 0 from right arm, and Grade 0 from right leg. Last VGE record at 355 minutes with Grade 0 from left arm, Grade 3 from left leg, Grade 0 from right arm, and Grade 2 from right leg. At 6<sup>th</sup>-hr questioning, subject reported right knee discomfort was same as before, and left ankle pain had gone. This was first indication that there was a symptom in left ankle. Symptoms in right knee



resolved during descent at 5.66 psia. During debrief at site pressure, subject said he did not report initial sensations in right ankle and right knee until they reoccurred later in the test. The logbook mentions there was a very clear remission of right knee symptoms during repressurization to site pressure. This description is inconsistent, however, since left ankle symptom mentioned at 6<sup>th</sup>-hr questioning was not mentioned during debrief, and right ankle symptom mentioned during debrief was never mentioned (documented) during test. What seems clear is that an ankle along with the right knee had symptoms.

**Diagnosis:** Grade 2 Type I DCS

**Treatment:** None, medical observation provided most likely for 12 h with follow-up consultation.

**30. Summary:** ID# 44-02, 36-year-old male, maximum Grade 4, first VGE at 42 minutes, first report at 68 minutes a symptom he noticed moments before, study done on n = 28, independent sample statistical design.

### **Procedure 7**

**Narrative:** At 68 minutes, subject reported very mild discomfort in right knee. Reported initial pain score of 1 on a 1–10 scale. For completeness, subject reported tingling sensations in thighs at 29 minutes. At 1<sup>st</sup>-hr questioning, subject mentioned symptoms in right knee had been present for the last couple of minutes, and were a continuous mild discomfort. There was no tingling in thighs at this time, and he suspected symptom was due to being warm. Pain score remained constant at 1 at 105, 119, and 165 minutes. Pain score only increased to 2 after 180 minutes. At 108 minutes, subject reported that pain was better localized, and was pain rather than discomfort on the right side of right patella. At 120 minutes, pain was reported to be a little less than it had been at previous report at 108 minutes, and was less painful compared to his previous exposure (44-01). At 125 minutes, pain score was 2 while straightening right leg during Doppler monitoring. At 3<sup>rd</sup>-hr questioning, reported that right ankle discomfort was gone from that noticed at 2<sup>nd</sup> hr. This was first indication in the logbook that he had a symptom in right ankle. Right knee pain was unchanged from 2<sup>nd</sup> hr. Left knee also has general discomfort, noticed about 15 minutes earlier, now at a pain score less than 1. Symptoms did not interfere with the exercise protocol. Pain score decreased back to 1 at 238, 289, 297, 327, and 359 minutes. First VGE detected at 42 minutes, Grade 0 from left arm, Grade 2 from left leg, Grade 0 from right arm, and Grade 1 from right leg. Last VGE record at 364 minutes with Grade 0 from left arm, Grade 2 from left leg, Grade 0 from right arm, and Grade 3 from right leg. At 4<sup>th</sup>-hr questioning, right knee pain was less, left knee discomfort was almost gone, with joints aggravated with movement but not noticeable when motionless. At 291 minutes, there was still discomfort in left knee, also pain in shin about one inch below left knee. Right knee still had pain when joint was moved, but no pain when joint was motionless. At 299 minutes, there was no discomfort in right knee, but some present in left knee; gave pain score of 1 for the shin just below left knee. At 326 minutes, subject reported that discomfort in right knee had returned; pain score of 1. At 6<sup>th</sup>-hr questioning, there was no discomfort in either ankle, but both knees still had same level of discomfort with an occasional sharp pain. His chamber mate (42-02) had also reported symptoms in right knee at 6<sup>th</sup>-hr questioning. Symptoms in both knees resolved during descent at 12.3 psia on the way to site pressure.

**Diagnosis:** Grade 2 Type I DCS

**Treatment:** None, medical observation provided most likely for 12 h with follow-up consultation.

**31. Summary:** ID# 61-03, 29-year-old male, maximum Grade 4, first VGE at 41 minutes, first report at 83 minutes a symptom he noticed at 78 minutes, study done on n = 28, independent sample statistical design.

### **Procedure 7**

**Narrative:** At 83 minutes, subject reported constant ache in joint, dull ache in left knee. Reported initial pain score of 2 on a 1–10 scale. He first noticed this symptom at 78 minutes, during last set of exercise activities, but did not interfere with his exercise activities. Pain score reported to increase to 3 by 2<sup>nd</sup>-hr questioning, at 128 minutes,; subject reported that flexing left knee at the Doppler monitoring station made dull ache worse. At 3<sup>rd</sup>-hr questioning, subject reported pain in left knee was at same level as before, a pain score of 3, but now left foot had a cramp symptom between toes and ankle. Symptom was described as “sharp;” a pain score of 2. At 220 minutes, subject reported an increase in pain score to 5 in left knee with trouble flexing the knee as required at the Doppler monitoring station. Symptom was described as still a dull ache, with no problems to continue the test or to walk to each exercise station. At 4<sup>th</sup>-hr questioning, subject reported a worse feeling in left ankle and left knee; a pain score of 6. He said that he preferred to put weight on his right leg, and that he limped a little. Pain was noticeable when he rotated the left ankle. MO decided to remove subject from the test. Initiated repressurization at 268 minutes. First VGE detected at 41 minutes, Grade 0 from left arm, Grade 3 from left leg, Grade 0 from right arm, and Grade 0 from right leg. Last VGE record at 253 minutes with Grade 0 from left arm, Grade 4 from left leg, Grade 2 from right arm, and Grade 2 from right leg. Symptoms in left knee and left ankle almost completely resolved during descent at 9.36 psia. During debrief at site pressure, subject mentioned that improvement in symptoms during repressurization was dramatic. Pain in left knee was localized beneath the patella and was at its worst at 4<sup>th</sup>-hr questioning.

**Diagnosis:** Grade 3 Type I DCS

**Treatment:** None, medical observation provided most likely for 12 h with follow-up consultation.

**32. Summary:** ID# 13-04, 36-year-old male, maximum Grade 4, first VGE at 88 minutes, first report at 205 minutes a symptom he noticed at 180 minutes, study done on n = 28, independent sample statistical design.

### **Procedure 7**

**Narrative:** At 205 minutes, subject reported constant, uncomfortable pain in left knee. Reported initial pain score of 3–4 on a 1–10 scale. He first noticed symptom at 3<sup>rd</sup>-hr questioning, but did not report it at that time. Symptom was noticed when he was lying on his back during a previous rest period. At 4<sup>th</sup>-hr questioning, subject reported pain in left knee

was perhaps a little less than previously reported, was not worse with movement, and did not interfere with his exercise activities. At 242 minutes, the score decreased to 3. At 302 minutes during 5<sup>th</sup>-hr questioning, subject reported left knee pain was about gone and not continuous. His chamber mate (46-01) had reported a symptom in right knee during 5<sup>th</sup>-hr questioning. First VGE detected at 88 minutes, Grade 0 from left arm, Grade 0 from left leg, Grade 0 from right arm, and Grade 1 from right leg. Last VGE record at 347 minutes with Grade 0 from left arm, Grade 3 from left leg, Grade 2 from right arm, and Grade 0 from right leg. At 6<sup>th</sup>-hr questioning, subject reported that pain in left knee was now gone, and had been absent since last report at 5<sup>th</sup>-hr questioning. Symptoms resolved while at the test altitude of 4.3 psia prior to the repressurization to site pressure.

**Diagnosis:** Grade 2 Type I DCS

**Treatment:** None, subject was advised to stay in the quarantine trailer for 12 h of medical observation, but did not stay. Follow-up consultation the next day was done.

### **Bends 3b: DCS Assigned at JSC**

**33. Summary:** ID# 63-01, 23-year-old male, maximum Grade 4, first VGE at 24 minutes, first report at 120 minutes a symptom he noticed at 90 minutes, study done on n = 35, independent sample statistical design.

#### **Procedure 8**

**Narrative:** At 120 minutes, subject reported intermittent stiffness in right ankle. Reported initial pain score of 1 on a 1–10 scale. He noticed symptoms about 30 minutes earlier. Pain score remained constant at 1 at 89 minutes, and decreased to 0 at 178 minutes; there was no stiffness in right ankle at the 3<sup>rd</sup>- to 6<sup>th</sup>-hr questioning. First VGE detected at 24 minutes, Grade 0 from left arm, Grade 0 from left leg, Grade 0 from right arm, and Grade 1 from right leg. Last VGE record at 350 minutes with Grade 0 from left arm, Grade 0 from left leg, Grade 0 from right arm, and Grade 0 from right leg. There were no symptoms prior to descent; symptoms resolved at the test altitude of 4.3 psia. Repressurization was back to 10.2 psia.

**Diagnosis:** Grade 1 Type I DCS

**Treatment:** None, just self-monitoring most likely with follow-up consultation.

**34. Summary:** ID# 60-01, 23-year-old male, maximum Grade 4, first VGE at 134 minutes, first report at 180 minutes a symptom he noticed about 160 to 165 minutes earlier. Symptoms reported at 300 minutes, but noticed at 297 minutes, are likely to be DCS-related, study done on n = 35, independent sample statistical design.

#### **Procedure 8**

**Narrative:** At 180 minutes, during 3<sup>rd</sup>-hr questioning, subject reported slight tingling in right wrist. Reported initial pain score of 1 on a 1–10 scale. He noticed pain about 160 to 165 minutes earlier, and it lasted a few minutes while pulling on the Pull Station exercise. Pain score remained constant at 1 at 180 minutes, then decreased to a pain score of 0 at 239 minutes, during

4<sup>th</sup>-hr questioning. At 5<sup>th</sup>-hr questioning, subject reported a stiff right ankle, not a soreness, that he had first noticed at the last exercise. He gave right ankle a pain score of 2 at 300 minutes. First VGE detected at 134 minutes, Grade 0 from left arm, Grade 0 from left leg, Grade 0 from right arm, and Grade 2 from right leg. Last VGE record at 350 minutes with Grade 0 from left arm, Grade 0 from left leg, Grade 0 from right arm, and Grade 3 from right leg. At 6<sup>th</sup>-hr questioning, subject reported a slight constant pain in right ankle, a little less noticeable than at 5<sup>th</sup>-hr questioning. There was no further report about right wrist. Symptoms in right ankle resolved during descent at 5.3 psia on the way to 10.2 psia. During debrief while at 10.2 psi, a subject mentioned that symptoms were best characterized as a constant awareness, not a pain.

**Diagnosis:** Grade 1 Type I DCS

**Treatment:** None, just self-monitoring most likely with follow-up consultation.

**35. Summary:** ID# 51-01, 26-year-old male, maximum Grade 0, first report at 240 minutes, study done on n = 35, independent sample statistical design.

### **Procedure 8**

**Narrative:** At 240 minutes, during 4<sup>th</sup>-hr questioning, subject reported a little fatigue in left arm but no pain. Did not report initial pain score on the 1–10 scale. At 5<sup>th</sup>-hr questioning, he still report some fatigue in left arm and assigned a 2–3 pain score. At 352 minutes, gave a final report of fatigue in left arm bicep. Subject had no VGE during the test. Last VGE record at 341 minutes with Grade 0 from left arm, Grade 0 from left leg, Grade 0 from right arm, and Grade 0 from right leg. Symptoms of fatigue in left arm resolved during descent at 7.4 psia on the way to 10.2 psia. During debrief while at 10.2 psia, subject said that feeling of fatigue was worse in 4<sup>th</sup>-hr questioning than toward 6<sup>th</sup>-hr questioning, but cleared up on repressurization to site pressure. There were never any numbness or pins-and-needles sensations.

**Diagnosis:** Grade 1 Type I DCS

**Treatment:** None, just self-monitoring most likely with follow-up consultation.

**36. Summary:** ID# 47-02, 26-year-old male, maximum Grade 4, first VGE at 39 minutes, first report at 123 minutes a symptom he noticed at 113 minutes, study done on n = 35, independent sample statistical design.

### **Procedure 8**

**Narrative:** At 123 minutes, subject reported ache in left knee. Reported initial pain score of 1 on a 1–10 scale. He noticed pain 10 minutes earlier at 113 minutes at the Doppler monitoring station. There was no ache while standing. Pain score remained constant a 1 at 184, 241, 300, and 360-minutes. At 2<sup>nd</sup>-hr questioning, subject reported left knee felt as though it had to be “popped” and had a dull pain. At 4<sup>th</sup>-, 5<sup>th</sup>-, and 6<sup>th</sup>-hr questioning, subject reported no change in symptoms in left knee. Pain was only noticeable at the Doppler monitoring station and only when lifting left leg. First VGE detected at 39 minutes, Grade 0 from left arm, Grade 3 from left leg, Grade 0 from right arm, and Grade 0 from right leg. Last VGE record at 358 minutes with Grade 0 from left arm, Grade 1 from left leg, Grade 0 from right arm, and Grade 0 from right leg.

Symptoms in left knee resolved during descent at 5.7 psia on the way to 10.2 psia. During debrief while at 10.2 psia, subject mentioned that pain, which was more like a discomfort, was less than he experienced in a previous test (47-01) where he also reported pain in left knee.

**Diagnosis:** Grade 2 Type I DCS

**Treatment:** None, just self-monitoring most likely with follow-up consultation.

**37. Summary:** ID# 8-04, 28-year-old male, maximum Grade 4, first VGE at 133 minutes, first report at 169 minutes a symptom he had at 164 minutes, study done on n = 35, independent sample statistical design.

### Procedure 8

**Narrative:** At 169 minutes, subject reported constant pain in right knee and right ankle. Reported initial pain score of 1 on a 1–10 scale. He reported that symptom was present 5 minutes earlier. At 3<sup>rd</sup>-hr questioning, reported no change in symptoms from right knee and right ankle. At 180 minutes, level was constant at 1; and at 208 minutes, level increased to 2, and was worse while moving left leg at the Doppler monitoring station. At 4<sup>th</sup>-hr questioning, pain score for right knee was 1, no mention of was made of right ankle, and a new symptom was reported in left knee at a pain score of 1. At 5<sup>th</sup>- and 6<sup>th</sup>-hr questioning, a pain score of 1 was given for right knee, right ankle, and left knee. His chamber mates (27-05 and 62-02) had also reported symptoms during this test. First VGE detected at 133 minutes, Grade 0 from left arm, Grade 0 from left leg, Grade 0 from right arm, and Grade 2 from right leg. Last VGE record at 351 minutes with Grade 0 from left arm, Grade 3 from left leg, Grade 1 from right arm, and Grade 2 from right leg. Symptoms in both knees and right ankle resolved during descent at 9.0 psia on the way to 10.2 psia.

**Diagnosis:** Grade 2 Type I DCS

**Treatment:** None, just self-monitoring most likely with follow-up consultation.

**38. Summary:** ID# 27-05, 40-year-old male, maximum Grade 4, first VGE at 256 minutes, first report at 334 minutes a symptom he noticed at 324 minutes, study done on n = 35, independent sample statistical design.

### Procedure 8

**Narrative:** At 334 minutes, subject reported mild pain in right knee. Reported initial pain score of 1 on a 1–10 scale. He reported that symptom was present at 324 minutes. At 6<sup>th</sup>-hr questioning, subject reported mild sensation in right knee, mostly present at the Doppler monitoring station when right leg was moved horizontally, and also noticed the sensation occasionally at other stations. His chamber mates (8-04 and 62-02) had also reported symptoms during this test. This subject had reported a symptom in the right knee at 76 minutes in a previous test (27-01). First VGE detected at 256 minutes, Grade 0 from left arm, Grade 0 from left leg, Grade 0 from right arm, and Grade 2 from right leg. Last VGE record at 348 minutes with Grade 1 from left arm, Grade 1 from left leg, Grade 1 from right arm, and Grade 4 from right leg. Symptoms resolved prior to descent, while at the test altitude of 4.3 psia. Repressurization was back to 10.2 psia.

**Diagnosis:** Grade 1 Type I DCS

**Treatment:** None, just self-monitoring most likely with follow-up consultation.

**39. Summary:** ID# 44-01, 36-year-old male, maximum Grade 4, first VGE at 107 minutes, first report at 225 minutes a symptom he noticed at about 221 minutes, study done on n = 35, independent sample statistical design.

### **Procedure 8**

**Narrative:** At 225 minutes, subject reported pain around the front in right ankle. Reported initial pain score of 8–9 on a 1–10 scale for a few seconds, and 3–4 for about 45 seconds; but at this time pain was gone. Pain score fluctuated during remainder of test. He first noticed right ankle symptom moments before, at about the time of last Doppler measurement at 221 minutes. For completeness, subject had initially reported tiredness in right wrist at 1<sup>st</sup>-hr questioning, and tiredness in right forearm at 2<sup>nd</sup>-hr questioning, with no tiredness in right wrist. At 3<sup>rd</sup>-hr questioning, he reported tiredness in right wrist, along back of right wrist, and in right forearm. At this time (180 minutes), he mentioned a momentary sharp pain on back of right wrist. At 4<sup>th</sup>-hr questioning, he reported that right ankle had no symptoms, but there was general tiredness in right knee at a pain score of 2. Pain was localized in front of right knee, below patella, but did not interfere with performance of the exercises. At 255 minutes, subject reported pain in right knee at a pain score of 2–3. At 268 minutes, subject reported right wrist and right knee hurt when he walked in the chamber but did not hurt when he stood still. At 273 minutes, there was no pain while motionless on the Doppler monitoring cot, but there was a noticeable discomfort in right knee and right ankle when right leg was moved from a horizontal position. He volunteered a pain score of 4. At 5<sup>th</sup>-hr questioning, pain in right knee was still present and given a pain score of 4 when walking; it did not interfere with walking. Pain was localized about 2 inches below patella. At 331 minute, subject reported slight discomfort in right knee and right ankle while sitting, a mild pain in these locations while walking, and overall less pain than previous reports. At 6<sup>th</sup>-hr questioning, subject reported no sharp pain anymore in right knee or right ankle, and not made worse by movement now; a pain score of 1 by inference. First VGE detected at 107 minutes, Grade 0 from left arm, Grade 0 from left leg, Grade 0 from right arm, and Grade 2 from right leg. Last VGE record at 369 minutes with Grade 0 from left arm, Grade 0 from left leg, Grade 1 from right arm, and Grade 2 from right leg. Symptoms in right knee and right ankle resolved during descent at 10.3 psia on the way to 10.2 psia.

**Diagnosis:** Grade 2 Type I DCS

**Treatment:** None, just self-monitoring most likely with follow-up consultation.

**40. Summary:** ID# 62-02, 32-year-old male, maximum Grade 1, first VGE at 103 minutes, first report at 120 minutes a symptom he noticed at 105 minutes, study done on n = 35, independent sample statistical design.

### **Procedure 8**

**Narrative:** At 120 minutes, during 2<sup>nd</sup>-hr questioning, subject reported fullness in left knee. Reported initial pain score of 1 - 2 on a 1–10 scale. He noticed symptom earlier at 105 minutes. At 3<sup>rd</sup>-hr questioning, subject reported that left knee was better now; no pain score reported. At 4<sup>th</sup>-, 5<sup>th</sup>- and 6<sup>th</sup>-hr questioning, there were no problem with left knee. His chamber mates (8-04 and 27-05) had also reported symptoms during test. First VGE detected at 103 minutes, Grade 0 from left arm, Grade 1 from left leg, Grade 0 from right arm, and Grade 0 from right leg. Last VGE record at 343 minutes with Grade 0 from left arm, Grade 0 from left leg, Grade 0 from right arm, and Grade 0 from right leg. VGE grade never exceeded 1, but was detected from left leg. There were no symptoms prior to descent; symptoms resolved at the test altitude of 4.3 psia. Repressurization was back to 10.2 psia.

**Diagnosis:** Grade 1 Type I DCS

**Treatment:** None, just self-monitoring most likely with follow-up consultation.

### **Bends 3c: DCS Assigned at JSC**

**41. Summary:** ID# 44-03, 36-year-old male, maximum Grade 2, first VGE at 77 minutes, first report at 105 minutes, study done on n = 14, independent sample statistical design.

#### **Procedure 9**

**Narrative:** At 105 minutes, subject reported discomfort in right ankle. At 2<sup>nd</sup>-hr questioning, subject reported steady discomfort in right ankle at initial pain score of less than 1 on a 1–10 scale. Pain score increased to 2 at 145 minutes; transient right hip discomfort had gone away. Pain score in right ankle then decreased to 1 at 157 and 178 minutes. At 4<sup>th</sup>-hr questioning, he reported a barely perceptible discomfort in right knee, right ankle had a continuous discomfort. Subject had reported pain symptoms in right ankle at 225 minutes during a previous exposure (44-01). First VGE detected at 77 minutes, Grade 0 from left arm, Grade 0 from left leg, Grade 1 from right arm, and Grade 0 from right leg. Last VGE record at 355 minutes with Grade 0 from left arm, Grade 0 from left leg, Grade 0 from right arm, and Grade 0 from right leg. At 5<sup>th</sup>-hr questioning, subject reported discomfort in right ankle had increased to a pain score of 2 when ankle was rotated, but discomfort did not interfere with his exercise activities. At 6<sup>th</sup>-hr questioning, pain score for right ankle had decreased to 1. Symptoms in right ankle resolved during descent to site pressure at 9.5 psia.

**Diagnosis:** Grade 2 Type I DCS

**Treatment:** None, medical observation provided most likely for 12 h with follow-up consultation.

**42. Summary:** ID# 48-03, 36-year-old male, maximum Grade 3, first VGE at 172 minutes, first report at 300 minutes a symptom he noticed at 296 minutes, study done on n = 14, independent sample statistical design.

#### **Procedure 9**

**Narrative:** At 300 minutes, during 5<sup>th</sup>-hr questioning, subject reported a dull aching pain in right knee. He noticed symptom at about 296 minutes while at the Doppler monitoring station. Reported initial pain score of 3–4 on a 1–10 scale, based on his recollection of first symptom. Now at 300 minutes, pain score decreased to 1. Right knee was more of a problem whenever he put weight on it. At 6<sup>th</sup>-hr questioning, he reported that right knee pain had been gone since shortly after 5<sup>th</sup>-hr questioning. His exposure to 4.3 psia the previous day (48-02) produced a symptom in right shoulder after the 5<sup>th</sup> hr at 4.3 psia. First VGE detected at 172 minutes, Grade 0 from left arm, Grade 0 from left leg, Grade 0 from right arm, and Grade 2 from right leg. Last VGE record at 352 minutes with Grade 0 from left arm, Grade 0 from left leg, Grade 0 from right arm, and Grade 0 from right leg. There were no symptoms prior to descent; symptoms resolved at the test altitude of 4.3 psia. During debrief at site pressure, subject mentioned that pain in right knee was localized below the patella and was intermittent. He also mentioned a little ill-defined pain in his right shoulder.

**Diagnosis:** Grade 2 Type I DCS

**Treatment:** None, medical observation provided most likely for 12 h with follow-up consultation.

**43. Summary:** ID# 10-07, 45-year-old male, maximum Grade 3, first VGE at 221 minutes, first report at 203 minutes a symptom he noticed at 201 minutes, study done on n = 14, independent sample statistical design.

### **Procedure 9**

**Narrative:** At 203 minutes, subject reported intermittent pain in left ankle. Reported initial pain score of 2–3 on a 1–10 scale. He noticed symptom at last exercise station, at about 201 minutes. At 4<sup>th</sup>-hr questioning, he reported pain in left ankle at a decreased pain score of 2; pain was associated with movement of ankle joint, was worse if he rose on tiptoes, and was least when sitting with weight off his feet. At 5<sup>th</sup>-hr questioning, left ankle discomfort was intermittent and subsided to a pain score of 1. At 6<sup>th</sup>-hr questioning, left ankle discomfort was still intermittent and subsided to a pain score of less than 1. First VGE detected at 221 minutes, Grade 0 from left arm, Grade 2 from left leg, Grade 0 from right arm, and Grade 0 from right leg. Last VGE record at 349 minutes with Grade 0 from left arm, Grade 0 from left leg, Grade 0 from right arm, and Grade 0 from right leg. Symptoms in left ankle resolved during descent at 6.3 psia. During debrief at site pressure, subject mentioned pain in left ankle was directly on the ankle, and on both sides.

**Diagnosis:** Grade 2 Type I DCS

**Treatment:** None, medical observation provided most likely for 12 h with follow-up consultation.

### **Bends 3d: DCS Assigned at JSC**

**44. Summary:** ID# 60-03, 23-year-old male, maximum Grade 4, first VGE at 105 minutes, first report at 239 minutes, study done on n = 12, independent sample statistical design.



## Procedure 10

**Narrative:** Subject had reported symptoms at 1 hr in left shoulder and left elbow the day before while at 4.3 psia. PI was not convinced that these were symptoms of DCS. During the morning prior to 2<sup>nd</sup> test to 4.3 psia, subject reported to PI that he had no aches or pains in the shoulder while at 10.2 psia for the evening. But when he awoke, he had a slight numbness in a leg that lasted 10 minutes until he moved around. The logbook was not clear which leg had a slight numbness. Subject was clear to perform the test. At 239 minutes, subject reported slight discomfort in left shoulder. Reported initial pain score of 3 on a 1–10 scale while exercising the limb; score decreased to 1 when not exercising the limb. Subject reported that pain was similar to that he experienced during the previous test, 1 day earlier. At 5<sup>th</sup>-hr questioning, subject still reported slight pain in left shoulder, with a pain score of 1. At 335 minutes, subject reported slight stiffness in right ankle that he noticed moments before while walking between exercise stations. He assigned it a pain score of 1–2. At 6<sup>th</sup>-hr questioning, subject reported slight pain in left shoulder, at a pain score of 3 with right ankle assigned a score of 4. Subject had previously reported (60-01) a symptom in right ankle at 5<sup>th</sup>-hr questioning of the test, but this was in a test that was conducted about 2 weeks earlier. First VGE detected at 105 minutes, Grade 0 from left arm, Grade 0 from left leg, Grade 0 from right arm, and Grade 3 from right leg. Last VGE record at 353 minutes with Grade 0 from left arm, Grade 0 from left leg, Grade 0 from right arm, and Grade 2 from right leg. Symptoms in right ankle resolved during descent at 9.5 psia, and symptoms in left shoulder were reported to feel better at 13 psia. During debrief at site pressure, the PI was not as clear that subject's left shoulder was a DCS problem, but was clear that right ankle pain was a clear DCS problem.

**Diagnosis:** Grade 2 Type I DCS

**Treatment:** None, medical observation provided most likely for 12 h with follow-up consultation.

**45. Summary:** ID# 42-05, 28-year-old male, maximum Grade 2, first VGE at 149 minutes, first report at 241 a symptom he noticed at 216 minutes, study done on n = 12, independent sample statistical design.

## Procedure 10

**Narrative:** Subject had no reported aches or pains during exposure to 4.3 psia the previous day. At 241 minutes, during 4<sup>th</sup>-hr questioning, subject reported ache in right ankle. Reported initial pain score of 3 on a 1–10 scale. He had first noticed symptom 25 minutes earlier; but ache did not interfere with exercise activities. First VGE detected at 149 minutes, Grade 0 from left arm, Grade 0 from left leg, Grade 1 from right arm, and Grade 2 from right leg. Last VGE record at 347 minutes with Grade 0 from left arm, Grade 0 from left leg, Grade 0 from right arm, and Grade 0 from right leg. At 5<sup>th</sup>-hr questioning, subject reported pain in right ankle had subsided to a pain score of 2, but was still a continuous pain. It felt worse when putting his weight on right ankle. He felt 2 distinct pains in right ankle while lying down: one on top of the ankle and one

under the ankle. Pain on top of the ankle was worse when lying down. At 6<sup>th</sup>-hr questioning, subject reported pain in right ankle only hurt when he put weight on it, but still about a pain score of 2 when weight was put on it. Symptoms in right ankle resolved during descent at 7.3 psia. During debrief at site pressure, subject localized right ankle pain to the muscle or tendons around the joint, and not to pain within the joint.

**Diagnosis:** Grade 2 Type I DCS

**Treatment:** None, medical observation provided most likely for 12 h with follow-up consultation.

## **Bends 4a: DCS Assigned at JSC**

**46. Summary:** ID# 64-01, 29-year-old male, maximum Grade 4, first VGE at 16 minutes, first report at 60 minutes a symptom he noticed at 24 minutes, study done on n = 12, independent sample statistical design.

### **Procedure 11**

**Narrative:** At 1<sup>st</sup>-hr questioning, subject reported that about 35 minutes earlier (24 minutes elapsed time) he experienced a slight dull ache in left elbow. At this time while at the Doppler monitoring station, he noticed a transient twinge in left knee and persistent twinge in right knee. Reported initial pain score of 1 on a 1–10 scale for left elbow and left knee, and a score of 3 for right knee. None of the 3 symptoms interfered with exercise activities. Pain score decreased to 1 at 119 minutes, and then decreased to 0 at 176 minutes. At 2<sup>nd</sup>-hr questioning, subject reported no noticeable aches or pain sensations at all from right knee, but characterized symptoms in left elbow and left knee as a very slight awareness. First VGE detected at 16 minutes, Grade 3 from left arm, Grade 3 from left leg, Grade 0 from right arm, and Grade 2 from right leg. Last VGE record at 162 minutes with Grade 2 from left arm, Grade 4 from left leg, Grade 1 from right arm, and Grade 4 from right leg. At 3<sup>rd</sup>-hr questioning, there were no symptoms to report, and the chamber was recompressed to 10.2 psia for a lunch break prior to second decompression of the day back to 4.3 psia. There were no symptoms prior to descent to 10.2 psia; symptoms resolved at the test altitude of 4.3 psia. Just after arriving at 10.2 psia for a lunch break, a Doppler reading was taken and subject had no VGE. Subject had no VGE on the second 3-hr exposure to 4.3 psia after the lunch break.

**Diagnosis:** Grade 2 Type I DCS

**Treatment:** None, just self-monitoring most likely with follow-up consultation.

## **Bends 5a: DCS Assigned at JSC**

**47. Summary:** ID# 91-01, 51-year-old female, maximum Grade 4, first VGE at 128 minutes, first report at 180 minutes a symptom she noticed at 165 minutes, study done on n = 38, independent sample statistical design.

### **Procedure 12**

**Narrative:** At 180 minutes, subject reported that right ankle hurt a little. Did not report initial pain score on the 1–10 scale. Ache was first noticed at the Doppler monitoring station, as a little twinge that came and went. Symptom did not interfere with exercise activities by 3<sup>rd</sup> hr. She mentioned that symptom had appeared about 15 minutes earlier (165 minutes); her only other report, at 2<sup>nd</sup>-hr questioning, was a transient cramp in her left side during previous exercise activity. At 180, 240, 300, and 360-minutes, level remained constant at 1. At 4<sup>th</sup>-hr questioning, she reported there was still an intermittent twinge in her right ankle, no better or worse than before, and a little more pronounced when she lay down at the Doppler monitoring station. At the 5<sup>th</sup>-hr questioning, she reported that right ankle still felt funny when rotating the joint. At 6<sup>th</sup>-hr questioning, she reported a slight discomfort in right ankle, but not as bad as previous reports. First VGE detected at 128 minutes, Grade 0 from left arm, Grade 0 from left leg, Grade 0 from right arm, and Grade 3 from right leg. Last VGE record at 344 minutes with Grade 0 from left arm, Grade 0 from left leg, Grade 0 from right arm, and Grade 1 from right leg. Subject had a right ear block during descent that diverted from detailed monitoring of any change in symptoms in right ankle. There were no symptoms in right ankle at site pressure. During debrief, she mentioned that mild pain had bothered her for about 2 h, but gradually became a very mild sensation by the end of the test.

**Diagnosis:** Grade 1 Type I DCS

**Treatment:** None, just self-monitoring most likely with follow-up consultation.

**48. Summary:** ID# 92-01, 45-year-old female, maximum Grade 3, first VGE at 277 minutes, first report at 300 minutes a symptom she noticed at 292 minutes, study done on n = 38, independent sample statistical design.

## Procedure 12

**Narrative:** At 300 minutes, during 5<sup>th</sup>-hr questioning, subject reported that right arm had experienced a hurtful sensation, in both the right wrist and right upper arm. Did not report initial pain score on the 1–10 scale. She noticed symptoms at about 292 minutes while at the previous Doppler monitoring station. At 300 minutes, symptom in right arm was all but gone. Feeling was slight in right wrist, arm, and upper arm. At 312 minutes, she felt a sensation in right arm while she was on the cot used for Doppler monitoring. Bubbles were not detected with confidence until 312 minutes into the test. There were Grade 2 and 3 VGE from the left and right leg with a single Grade 1 VGE from the right arm at 312 minutes. She reported no symptoms at 328 minutes or at 360-minutes. First VGE detected at 277 minutes, Grade 0 from left arm, Grade 2 from left leg, Grade 0 from right arm, and Grade 0 from right leg. Last VGE record at 348 minutes with Grade 0 from left arm, Grade 0 from left leg, Grade 0 from right arm, and Grade 0 from right leg. There were no symptoms prior to descent; symptoms resolved at the test altitude of 4.3 psia. During debrief, she mentioned that there was pain also in her right shoulder, and all symptoms in the right arm had appeared during the Doppler monitoring period just prior to and just after the 4<sup>th</sup> hr of the test.

**Diagnosis:** Grade 2 Type I DCS

**Treatment:** None, just self-monitoring most likely with follow-up consultation.

**49. Summary:** ID# 96-01, 27-year-old male, maximum Grade 4, first VGE at 39 minutes, first report at 60 minutes a symptom he noticed minutes earlier, study done on n = 38, independent sample statistical design.

### **Procedure 12**

**Narrative:** At 60 minutes, subject reported pain in left ankle. Did not report initial pain score on the 1–10 scale. He reported that pain was first noticed during the previous Doppler monitoring, and ached only when the joint was rotated. At 80 minutes, he reported that pain had spread to left knee and felt “like when you need to pop a knuckle,” but it did not interfere with exercise activities. At 2<sup>nd</sup>-hr questioning, subject reported that left ankle pain was only noticeable when moving the joint, and left knee pain had not changed in intensity or character since the last report at 80 minutes. At 3<sup>rd</sup>-hr questioning, the left ankle felt okay, but there was still pain in the left knee especially during the Doppler monitoring. He reported a new pain in the right ankle, which appeared about 30 minutes earlier. Pain score remained constant at 1 at 80, 120, 150, 180, 199, 219, and 240 minutes, but increased to 9–10 at 300 and 360-minutes. At 219 minutes, subject reported that right knee pain was noticeable while just quietly sitting, but still not severe enough to interfere with exercise activities. At 4<sup>th</sup>-hr questioning, pain in left ankle was the same, a decrease of pain in the left knee, right ankle, and right knee. At 5<sup>th</sup>-hr questioning, subject reported that left knee, left ankle, right knee, and right ankle were the same as before. However, at this time subject volunteered a pain score of 9–10, but the logbook does not specify the location for these scores. At 6<sup>th</sup>-hr questioning, subject reported left leg had less intense pain than right leg. First VGE detected at 39 minutes, Grade 0 from left arm, Grade 2 from left leg, Grade 2 from right arm, and Grade 0 from right leg. Last VGE record at 356 minutes with Grade 0 from left arm, Grade 1 from left leg, Grade 0 from right arm, and Grade 3 from right leg. Symptoms in both legs (knees and ankles) resolved during descent at 5.0 psia at the same time. During debrief, subject volunteered that left ankle had become sore on movement about 30 minutes into the test, and pain had spread to left knee after about 10–15 minutes. Pain had intensified over the next hr. Then about 3 h into the test, the right ankle and right knee followed the same pattern of symptom onset. There were periods where symptoms were more noticeable, especially during the Doppler monitoring periods or when getting up from a seated or lying position.

**Diagnosis:** Grade 2 Type I DCS

**Treatment:** None, just self-monitoring most likely with follow-up consultation.

**50. Summary:** ID# 97-01, 36-year-old female, maximum Grade 4, first VGE at 91 minutes, first report at 112 minutes a symptom she noticed at 104 minutes, study done on n = 38, independent sample statistical design.

### **Procedure 12**

**Narrative:** At 112 minutes, subject reported dull ache in right knee. Reported initial pain score of 1 on a 1–10 scale. Subject reported that she first noticed ache at about 104 minutes after completing the Doppler monitoring, and it did not interfere with her exercise activity. Pain score increased to 2 at 120 and 132 minutes, and then increased to 4–5 at 149 minutes followed by a decrease to 3 at 180 minutes. At 120 minutes, during 2<sup>nd</sup>-hr questioning, she said that ache in

right knee was just a little worse than before. It was a continuous ache that did not interfere with her performance. At 132 minutes, subject reported that right knee was getting tender to walk on, and she needed to limp to get to the different exercise stations. At 144 minutes, subject reported a dull sensation in right hip that felt like the sensation she first had in right knee, but at a lower intensity than was in right knee at that time. At 149 minutes, subject reported that right ankle was now hurting, but she was still able to walk from station to station. At 3<sup>rd</sup>-hr questioning, she reported that an ache was still present in right knee and right ankle, but pain in right hip was not as bad as before. A pain score of 2.5 was provided, but it was unclear if this was for one or all the locations. An earlier report at 155 minutes of pain in the left ankle of the DT had increased, and the DT's right ankle had become involved at 192 minutes. At 194 minutes both knees, and especially the right knee, of the DT became painful enough to cause the early termination of the test. First VGE for subject was detected at 91 minutes, Grade 0 from left arm, Grade 0 from left leg, Grade 0 from right arm, and Grade 2 from right leg. Last VGE record at 176 minutes with Grade 0 from left arm, Grade 0 from left leg, Grade 2 from right arm, and Grade 3 from right leg. Symptoms in right knee, right ankle, and right hip for subject resolved dramatically during descent at 5.9 psia. During debrief, subject mentioned that pain in right ankle went from a pain score of 6 to a pain score of about 2 toward the end of the test.

**Diagnosis:** Grade 2 Type I DCS

**Treatment:** None, just self-monitoring most likely with follow-up consultation.

## **Bends 6: DCS Assigned at JSC**

**51. Summary:** ID# 109-01, 31-year-old male, maximum Grade 3, first VGE at 98 minutes, first report at 182 minutes a symptom he noticed at 152 minutes, study done on n = 29, independent sample statistical design.

### **Procedure 13**

**Narrative:** At 182 minutes, at the 3<sup>rd</sup>-hr questioning, subject reported a dull pain localized in the belly of left bicep, but no joint pain. Did not report initial pain score on the 1–10 scale. During debrief, he mentioned that symptom had appeared about 30 minutes earlier. At 4<sup>th</sup>-hr questioning, subject reported that he still had a dull continuous pain in his left arm. At 180, 240, 300, and 360-minutes, the pain score remained constant at 1. At 240 minutes, subject reported there was still a dull pain in left arm. At 300 minutes, pain was receding; by 360-minutes, there was still some pain in left arm. At 6<sup>th</sup>-hr questioning, he also volunteered that he experienced a slight ache in right ankle when he walked on right leg. But ache was gone when he sat quietly (he later recalled that he had symptoms in right ankle while resting just prior to repressurization). First VGE detected at 98 minutes, Grade 0 from left arm, Grade 0 from left leg, Grade 0 from right arm, and Grade 1 from right leg. Last VGE record at 356 minutes with Grade 0 from left arm, Grade 0 from left leg, Grade 0 from right arm, and Grade 0 from right leg. Symptoms in left arm and right ankle did not clear during descent, but were resolved at site pressure. During debrief, he reported that he first noticed pain in left arm as a dull sensation about 30 minutes before reporting it. This dull pain was in the tricep muscle (bicep was mentioned in another section of the logbook, but it appears to have been in the tricep), and was a continuous pain. Subject was

asked to turn the ergometer at site pressure and to walk about to see if any symptoms were present in the right ankle or left arm. Subject reported that the symptoms were amazingly diminished, and no pain was present in any limb by the end of debrief. Subject was contacted 48 hr later by the PI. Subject mentioned that he had twisted his right ankle 4 or 5 times in the past 4 or 5 years, and that he did recall having symptoms in his right ankle just prior to repressurization to site pressure at the end of the 6-hr test.

**Diagnosis:** Grade 1 Type I DCS

**Treatment:** None, just self-monitoring most likely with follow-up consultation.

## **Bends 7a (high exercise): DCS Assigned at JSC**

**52. Summary:** ID# 123-01, 28-year-old male, maximum Grade 4, first VGE at 61 minutes, first report at 90 minutes, study done on n = 11, crossover dependent sample statistical design.

### **Procedure 14**

**Narrative:** At 90 minutes, subject reported a cramp in lower right leg (calf). Did not report initial pain score on a 1–10 scale. Still had cramp at 94 minutes, but did not have it during practice exercise at site pressure. There was no pain score report at 121, 161, or 172 minutes into the test. At 100 minutes, the cramp had diminished. At 120 minutes, he reported a slight headache in frontal area and pain in bell of muscle of right calf; the pain was present most of the time now. At 127 minutes, the PI noted that what started out as a cramp was now a mild throbbing that had diminished in discomfort. At 164 minutes, he reported pain in right knee, shooting and throbbing, “pretty good jab of pain.” When he had right knee up, it hurt; when it was extended, the pain diminished. Pain was in back of, in front of, and all around knee, but did not interfere with performance. First VGE detected at 61 minutes, Grade 0 from left arm, Grade 4 from left leg, Grade 1 from right arm, and Grade 4 from right leg. Last VGE record at 161 minutes with Grade 0 from left arm, Grade 3 from left leg, Grade 0 from right arm, and Grade 3 from right leg. At 172 minutes, subject reported dizziness and sudden onset of “wobbly” and then blurred vision. Test was immediately aborted. Symptoms were clearing within 2 minutes of repressurization to site pressure. Vision cleared at 10.1 psia, headache cleared at 10.9 psia, and knee pain resolved just prior to return to site pressure (13.7 to 14.7 psia). At debrief, he described last symptom as dizziness associated with at first a “wobbly” vision that he found hard to describe, then a blurring of vision. There were no signs of posttest neurological deficit.

**Diagnosis:** Type II DCS with Grade 3 Type I DCS

**Treatment:** Two-hr GLO, 12-hr medical observation, then released from study with follow-up consultation. Subject did have a PFO, with positive indication at rest. Dr. Meehan made additional ophthalmic observations with a fundus camera immediately after the return to site pressure, but comments in the logbook were illegible.

**53. Summary:** ID# 121-01, 30-year-old male, maximum Grade 4, first VGE at 49 minutes, first report at 75 minutes, study done on n = 11, crossover dependent sample statistical design.

### **Procedure 14**

**Narrative:** At 75 minutes, subject reported continuous pain in left-hand ring finger, at joint just behind fingernail. Did not report initial pain score on the 1–10 scale. At 83 minutes and 96 minutes, pain in left-hand ring finger was almost gone. By 102 minutes, there was no pain in left-hand ring finger. Pain score was not reported at 155 or 160 minutes into test. At 159 minutes, he reported pain in right knee, just below the patella. Subject reported that he noticed the sharp pain about 30 seconds before reporting it. It was determined that although it caused repeated pain on the row machine, this did not interfere with performance. First VGE detected at 49 minutes, Grade 0 from left arm, Grade 1 from left leg, Grade 0 from right arm, and Grade 0 from right leg. Last VGE record at 164 minutes with Grade 2 from left arm, Grade 2 from left leg, Grade 2 from right arm, and Grade 4 from right leg. At 172 minutes, he reported pain behind right eye; a throbbing headache localized behind right eye felt like a sinus headache. Test was aborted, and recompression to site pressure began approximately 8 minutes from the report of pain behind the right eye. Headache was diminishing with increased ambient pressure; knee pain was greatly reduced but still some awareness at site pressure. Ophthalmologic examination at site pressure revealed some sheathing of vessels and some change in the ground. While waiting for the chamber to be readied, the headache did not resolve and may have increased its focal area and intensity. Both headache and residual knee pain were resolved during the treatment. Ophthalmologic signs decreased during treatment. At no time did subject have visual symptoms.

**Diagnosis:** Type II DCS and Grade 2 Type I DCS

**Treatment:** One-hr GLO prior to USN HBO TT VI, medical observation for 12 h with follow-up consultation over the next several days. A final ophthalmologic exam was negative. Did not have a detectable PFO.

Test Director's / Principal Investigator's Special Report on Bends VII Test 11

Eleventh test of the Bends VII Test Series was conducted on 1/13/89. The test subjects are designated as Subject #1 (122-02), who was conducting the low metabolic rate profile and Test Subject #2 (121-01), who was conducting the high metabolic rate profile. The DT was JC, the Test Director was JW, the Test Investigator was Dr. KV and the test Surgeon was Dr. PS. Each of the test subjects had already completed one of the paired tests called for in the test series plan. Venous bubbles had been detected on both subjects during their previous run. Test subject #1 had experienced no symptoms during his prior high metabolic rate run. Test subject #2 had experienced simple limb bends in his left knee in the conduct of his low metabolic rate test. This symptom was judged to be Grade 2 limb bends and did not result in an early termination of that test. The symptom was resolved upon return to site pressure at the end of the test. Subject was observed for 12 h and released without further symptoms. The test series protocol called for each of the test subjects to have a fundus camera measurement after one of their 2 test runs. Subject #1 had not had the measurement on his previous run and so was scheduled to have it on this run. Subject #2 had this measurement on his previous run and was not scheduled to have the measurement on this run.

The test was begun with the start of ascent to 10,000 feet at 9:21. The start of ascent to 21,000 feet, the test altitude, was at 9:24. The test altitude, 21,000 feet was reached at 9:28 and the elapsed time clock was started at 0:00 at this same time. At this time subjects were asked the baseline question about any pain or discomfort. Subject #2 stated that he had measles shot about four days ago and that his right deltoid was a little sore. He reported that he had no other aches or pains. Subject #1 reported no ache or pain.

Subjects then began their test exercises that they were to sustain for the three h and 16 minutes of the planned test duration. After 1 hr, in response to questioning, subject #1 reported everything was fine except for a dry mouth. Subject #2 reported he had no aches or pains other than the right shoulder where the soreness was less noticeable than originally. At an elapsed time of 1 hr and 15 minutes, subject #2 reported pain in the left fourth finger, left hand next to the little finger. This was a continuous pain in the knuckle, first joint right behind the fingernail. This pain

was not interfering with performance and the test continued. At an elapsed time of 1 hr and 23 minutes crewman #2 reported that the pain in the finger was almost gone. At an elapsed time of 1 hr and 24 minutes subject #1 reported a sharp momentary pain in the right elbow that was then continuous at a lower level that did not interfere with performance. At an elapsed time of 1 hr and 36 minutes both subjects were questioned about their symptoms. Subject #2 reported that his finger pain was much better, almost gone. Subject #1 reported that his elbow was still a little painful but not like it was on the rowing machine, where he first reported the symptom. At an elapsed time of 1 hr and 42 minutes subject #2 was questioned and said he had no pain in his finger. At an elapsed time of 1 hr and 46 minutes Subject #1 reported that the pain in the elbow was just about cleared up. This was immediately after working on the rowing machine where the symptom was first reported. At about this time there was an error in the exercise routine that resulted in subject #2 working at the peak exercise rate of 2,000 Btu/hr for 20 minutes rather than the planned 16 minutes. So four additional minutes of the subsequent work rate, which should have been at the 1440 Btu / hr rate, was at 2,000 Btu/hr.

At the end of the second hr, after all the high exercise in the high exercise protocol was completed, in response to the hrly questions, Subject #1 stated that his right shoulder and his right elbow were a little sore, but nothing like at the time it first appeared on the rowing machine. This was the first time subject had mentioned his shoulder. He was asked about this and replied that when he first described the elbow pain, the shoulder did not hurt and now it does but that it could be due to his body position during the Doppler monitoring (on his left side) which is very uncomfortable. The sensations are separate and distinct, and they are continuous. They did not interfere with performance. Subject #2 reported no symptoms. He was asked about his finger and reported that the previous pain in the finger was completely gone.

The test was continued into the third hr according to protocol. In chamber blood draws were done in the first 30 minutes of this hr so there is some reduction in the work activity during this period. At an elapsed time of 2 hr and 39 minutes Subject #2 reported that he had a pain originating right below the kneecap of the right knee and that he stated having sharp pains thereafter. He had this pain for about 30 seconds before contacting us. The subject was stopped in his exercise sequence while he was being questioned. The Investigator and the Surgeon asked subject questions to determine if the symptoms were Grade 2 or Grade 3 symptoms interfering with performance. Subject said that he could continue without much trouble but with some pain. At this point the scheduled rowing activity was completed and subject was asked to move to the next station, which was the Doppler station he did so without limping. It was determined that the symptoms were Grade 2, and the test was continued. At an elapsed time of 2 hr and 52 minutes Subject #2 reported pain behind the right eye. Subject was seated and questioned by the test Surgeon. He reported a throbbing headache behind the eye, more specifically behind the right eye. At one point he said it feels like a sinus headache. At 3 hr elapsed time the test was aborted. At that time subject #1 reported no pain anywhere even when he moved his right elbow and shoulder. Subject #2 had some pain in the right knee but only when he moves it around. He still had the headache. During repress to site pressure at 10,000 feet subject #2 reported no change in symptoms. At 5,000 feet he reported that the headache was dispersing, not as bad. At site pressure subject #2 reported that he felt pretty good, still some headache, leg pain none, hardly at all. Ophthalmologic examination revealed some sheathing around major vessels and some change in color of the ground. The decision was made to treat with a table 6 treatment. Subject #2 was held in the altitude chamber on O<sub>2</sub> until the hyperbaric chamber was ready. Altitude chamber reached site pressure at an elapsed time of 3 hr and 4 minutes, a clock time of about 12:28. At 12:37 a posttest Doppler on subject #2 showed he still had some bubbles on movement of the right leg. Subject was transported to the hyperbaric chamber at 1:34 and treatment was started at about 1:42. Details of the treatment are reported in the outside MO report of the treatment. Subject had both CNS and limb bends symptoms at the beginning of the treatment and the symptoms disappeared during the 60-foot portion of the treatment table. The ophthalmologic signs also decreased during the treatment. All signs and symptoms were gone at the completion of the treatment. Fundus camera photographs of the eyes were taken that evening. Subject was observed for the next 12 h without incident and follow-up was continued for the next several days. A visual field mapping procedure is scheduled with a local ophthalmologist on 1/24/89. At no time has subject had any visual symptoms, and has no residual symptoms of any kind.

**54. Summary:** ID# 120-01, 23-year-old male, maximum Grade 4, first VGE at 81 minutes, first report at 78 minutes, study done on n = 11, crossover dependent sample statistical design.

## Procedure 14



**Narrative:** At 78 minutes, subject reported slight pain under patella of left knee. Reported initial pain score of 1 on a 1–10 scale. At 93 minutes, subject reported that pain had increased to a 2–3, and was constant. At 103 minutes, pain was described as located in the front and back of left knee, was constant, and had a pain score of 3. At 2<sup>nd</sup>-hr questioning, subject reported that pain in left knee was spreading down left leg, and that both wrists had a pain score of 1 on flexing the wrists. At 145 minutes, subject reported that left knee pain had somewhat subsided. At 3<sup>rd</sup>-hr questioning, subject reported no pain in the wrists, and left knee pain was still at a pain score of 3. First VGE detected at 81 minutes, Grade 0 from left arm, Grade 1 from left leg, Grade 0 from right arm, and Grade 1 from right leg. Last VGE record at 192 minutes with Grade 0 from left arm, Grade 3 from left leg, Grade 0 from right arm, and Grade 2 from right leg. Symptoms in left knee resolved during descent at 7.65 psia.

**Diagnosis:** Grade 2 Type I DCS

**Treatment:** One-hr GLO, under medical monitoring for 12 h. Posttest GLO was extended 10 minutes due to complaint of chest tightness after the fundus camera pictures of the eyes were completed. Follow-up consultation the next day was done.

**55. Summary:** ID# 117-01, 26-year-old male, maximum Grade 4, first VGE at 49 minutes, first report at 169 minutes a symptom he noticed minutes earlier, study done on n = 11, crossover dependent sample statistical design.

#### **Procedure 14**

**Narrative:** At 169 minutes, subject reported a dull ache in left knee that was noticed during earlier exercise period and was intermittent while pushing on the joint during exercise. Did not report initial pain score on the 1–10 scale. Ache was not present at the time of the report at 169 minutes. At 175 minutes, subject reported that there was a dull ache in left knee when he lifted his left leg off the floor. At 3<sup>rd</sup>-hr questioning, subject reported that left knee had a dull but clear low level of pain that did not interfere with any activities, and that knee felt like it was over-extended. Pain score was not reported at 181 minutes into test. First VGE detected at 49 minutes, Grade 0 from left arm, Grade 2 from left leg, Grade 0 from right arm, and Grade 0 from right leg. Last VGE record at 193 minutes with Grade 0 from left arm, Grade 2 from left leg, Grade 0 from right arm, and Grade 0 from right leg. At 185 minutes, subject reported no symptoms in left knee using the row machine; but at 200 minutes on the row machine, there was a symptom, but not on standing. It is not clear why the test was extended by approximately 24 minutes, but recompression began at 204 minutes with no report of left knee symptoms then. Subject did not report if there was a change in left knee symptoms during descent.

**Diagnosis:** Grade 2 Type I DCS

**Treatment:** One-hr GLO with follow-up consultation.

**Bends 7b (low exercise): DCS Assigned at JSC**

**56. Summary:** ID# 121-02, 30-year-old male, maximum Grade 4, first VGE at 64 minutes, first report at 119 minutes a symptom he noticed at about 109 minutes, study done on n = 11, crossover dependent sample statistical design.

### **Procedure 15**

**Narrative:** At 119 minutes, subject reported ache in left knee, left ankle, and right shoulder. Did not report initial pain score on the 1–10 scale. Subject reported that ache in left knee was noticed about 10 minutes earlier, was hurting more during the row machine exercise, and was now continuous. Left ankle ache was noticed only on the row machine, with right shoulder ache occurring only once or twice during previous exercise. Pain score was not reported at 178 or 194 minutes into test. First VGE detected at 64 minutes, Grade 2 from left arm, Grade 3 from left leg, Grade 2 from right arm, and Grade 0 from right leg. Last VGE record at 185 minutes with Grade 2 from left arm, Grade 4 from left leg, Grade 1 from right arm, and Grade 4 from right leg. At 3<sup>rd</sup>-hr questioning, subject reported a little discomfort in left knee; discomfort had not changed from previous reports. Left ankle and right shoulder pain had gone by the end of the test. Subject reported that he still felt something in his left knee during descent, but that knee was a lot better. During debrief, subject reported that there was still an awareness in left knee, but not pain. There was a discussion about pretest symptoms in the left knee that may have influenced the incomplete posttest response to recompression to site pressure. There were no symptoms in left knee at the conclusion of the posttest period of GLO.

**Diagnosis:** Grade 2 Type I DCS

**Treatment:** One-hr GLO with follow-up consultation.

**57. Summary:** ID# 122-02, 45-year-old male, maximum Grade 3, first VGE at 25 minutes, first report at 84 minutes, study done on n = 11, crossover dependent sample statistical design.

### **Procedure 15**

**Narrative:** At 84 minutes, subject reported a sharp pain in right elbow, like pain from the stick of a needle. Pain did not interfere with performance of formal exercise protocol. Did not report initial pain score on the 1–10 scale. Pain score was not reported at 120 minutes, but it was reported as 0 at 179 minutes. At 96 minutes, subject reported that right elbow was still a little painful, but not like it was at report from the row machine. No VGE detected from left arm or right arm, but Grade 2 VGE were detected after 25 minutes in the right and left leg. First VGE detected at 25 minutes, Grade 0 from left arm, Grade 2 from left leg, Grade 0 from right arm, and Grade 2 from right leg. Last VGE record at 169 minutes with Grade 0 from left arm, Grade 0 from left leg, Grade 0 from right arm, and Grade 0 from right leg. Grade increased to 3, mostly in right leg. Test was terminated earlier than planned at just less than 3 h due to a Type II symptom in his chamber mate (121-01). There were no symptoms prior to descent; symptoms resolved at the test altitude of 6.5 psia. During debrief, pain in right elbow was described as having come on quickly, and as stabbing needles. Pain was continuous at lower levels but did not interfere with

subject's ability to perform the exercises. Subject said pain in right shoulder was over the scapula area, and only lasted 10 minutes.

**Diagnosis:** Grade 2 Type I DCS

**Treatment:** One-hr GLO with follow-up consultation.

### **Bends 8a:(no prior treadmill exercise) DCS Assigned at JSC**

**58. Summary:** ID# 146-02, 35-year-old male, maximum Grade 1, first VGE at 37 minutes, first report at 54 minutes a symptom he noticed at 42 minutes, study done on n = 40, crossover dependent sample statistical design.

#### **Procedure 16**

**Narrative:** At 54 minutes, subject reported pain in both right knee and left knee. Reported initial pain score of 6 on a 1–10 scale, but said right knee was more severe than left knee. During previous period at Doppler monitoring station, he said pain became more severe and standing did not help it. He first noticed symptoms in right knee at about 42 minutes; then about 3 minutes later, the left knee began to ache. Pain score increased to 8 at 60 minutes into test. Due to the intolerable nature and rapid onset of the knee pains, a decision was made to remove subject from the chamber. Initiated repressurization at 60 minutes. First VGE detected at 37 minutes, Grade 0 from left arm, Grade 0 from left leg, Grade 0 from right arm, and Grade 1 from right leg. Last VGE record at 37 minutes with Grade 0 from left arm, Grade 0 from left leg, Grade 0 from right arm, and Grade 1 from right leg. Symptoms in both knees improved during descent such that at 10.1 psia discomfort had decreased to a pain score of 3 while standing. Symptoms completely resolved during descent at 11.34 psia. During debrief, subject said right knee ache was first like a muscle “kink.” He said that both knees and thigh (first time mentioned in notes) had fairly severe pain in the joint. This last statement is as clear as debrief notes allow.

**Diagnosis:** Grade 3 Type I DCS

**Treatment:** Two-hr GLO with follow-up consultation.

**59. Summary:** ID# 139-02, 23-year-old male, maximum Grade 0, first report at 80 minutes a symptom he noticed moments earlier, study done on n = 40, crossover dependent sample statistical design.

#### **Procedure 16**

**Narrative:** At 80 minutes, subject reported awareness in right ankle. Reported initial pain score of 2 on a 1–10 scale. Awareness did not interfere with exercise activities, and subject realized symptom moments earlier. Pain score remained constant at 2 at 120 minutes for right ankle. Subject also volunteered a pain score of 1 for a slight ache in middle of the back at 120 minutes. At 3<sup>rd</sup>-hr questioning, there was still a pain score 2 in right ankle. Last VGE record at 174 minutes with Grade 0 from left arm, Grade 0 from left leg, Grade 0 from right arm, and Grade 0 from right leg. No VGE were detected in this subject. Symptoms in right ankle resolved during descent at 8.8 psia.

**Diagnosis:** Grade 1 Type I DCS

**Treatment:** One-hr GLO with follow-up consultation.

**60. Summary:** ID# 147-01, 42-year-old male, maximum Grade 4, first VGE at 64 minutes, first report at 104 minutes, study done on n = 40, crossover dependent sample statistical design.

### **Procedure 16**

**Narrative:** At 104 minutes, subject reported occasional pain in left knee. At 2<sup>nd</sup>-hr questioning, subject reported that left knee still hurt slightly, with steady pain. Reported pain score of 1 on a 1–10 scale. At 120 minutes, subject reported that left knee still hurt slightly; steady pain at patella. Pain does not interfere with movement. At 140 minutes, subject made his last report that left knee still hurt, and the test was terminated 3 minutes later since a second subject (149-01) had been removed earlier and was undergoing HBO treatment that could not be interrupted with a second case of DCS that might require HBO. First VGE detected at 64 minutes, Grade 2 from left arm, Grade 2 from left leg, Grade 0 from right arm, and Grade 3 from right leg. Last VGE record at 137 minutes with Grade 2 from left arm, Grade 4 from left leg, Grade 0 from right arm, and Grade 3 from right leg. Symptoms in left knee resolved during descent at 7.65 psia.

**Diagnosis:** Grade 2 Type I DCS

**Treatment:** One-hr GLO with follow-up consultation.

**61. Summary:** ID# 138-01, 44-year-old male, maximum Grade 4, first VGE at 29 minutes, first report at 60 minutes, study done on n = 40, crossover dependent sample statistical design.

### **Procedure 16**

**Narrative:** At 60 minutes, subject reported awareness in right knee. Did not report initial pain score on the 1–10 scale. Initially reported at 45 minutes mild pain in left upper arm that extended along bicep during the Pull Station exercise. At 51 minutes, there was no arm pain while working at the Crank Station exercise. At the time of the report about the right knee, there was no further pain in left upper arm. At 83, 95, and 120 minutes there was no pain in right knee. First VGE detected at 29 minutes, Grade 0 from left arm, Grade 3 from left leg, Grade 0 from right arm, and Grade 2 from right leg. Last VGE record at 177 minutes with Grade 0 from left arm, Grade 4 from left leg, Grade 0 from right arm, and Grade 4 from right leg. Subject completed test and reported no symptoms at 180 minutes. There were no symptoms prior to descent; symptoms resolved at the test altitude of 6.5 psia. Pain reoccurred in right knee at a more severe level 15 h after the test. He reported soreness in both knees.

**Diagnosis:** Grade 2 Type I DCS

**Treatment:** One-hr GLO and USN TT V HBO for reoccurrence of right knee symptom with symptom resolution. Follow-up consultation the next day was done.

**62. Summary:** ID# 133-02, 31-year-old female, maximum Grade 4, first VGE at 41 minutes, first report at 105 minutes, study done on n = 40, crossover dependent sample statistical design.

## Procedure 16

**Narrative:** At 105 minutes, subject reported sharp intermittent pain in right leg, from knee to ankle. Reported initial pain score of 1 on a 1–10 scale on movement of right leg. There was no pain score report at 120 minutes, but subject reported stiffness in right knee. At about 124 minutes, subject reported pain in right leg; it was sharp and intermittent only on movement. At 143 minutes, subject reported that she could not straighten her right leg, and the pain score had increased to 3.5–4.0. After 158 minutes, she reported severe pain on movement of both the right knee and right ankle and lesser continuous pain at both sites. Test was terminated for subject at this time. First VGE detected at 41 minutes, Grade 0 from left arm, Grade 0 from left leg, Grade 0 from right arm, and Grade 3 from right leg. Last VGE record at 138 minutes with Grade 0 from left arm, Grade 4 from left leg, Grade 0 from right arm, and Grade 4 from right leg. Symptoms in right knee were gone by 10.1 psia, with right ankle pain gone near site pressure at about 13.7 psia. Posttest VGE monitoring 48 minutes after start of repressurization showed no VGE. Onset of fatigue reported 20 minutes after reaching site pressure, which subject attributed to a long day of exercise. Limb pain reoccurred after 2.5 h on O<sub>2</sub>.

**Diagnosis:** Grade 3 Type I DCS

**Treatment:** A 2.5-hr GLO and USN TT V HBO with symptom resolution. Follow-up consultation the next day was done.

**63. Summary:** ID# 127-01, 25-year-old male, maximum Grade 4, first VGE at 63 minutes, first report at 129 minutes, study done on n = 40, crossover dependent sample statistical design.

## Procedure 16

**Narrative:** At 129 minutes, subject reported pain in right ankle. Reported initial pain score of 1 on a 1–10 scale. Pain was described as diffuse, and more in the right foot and towards the medial boarder. There was no tingling or numbness. The pain was on both sides of the right foot. At 145 minutes, symptom was reduced and described as a mild discomfort in right ankle. At 161 minutes, subject mentioned that pain around the right ankle was more noticeable at the Doppler station when his weight was off his feet, and was not present during other exercise activities. At 166 minutes, subject reported a new symptom of numbness under right knee, with discomfort still present on right ankle. At 175 minutes, a pain score of 8 was reported for top of right foot, with numbness still present under right knee, very slight and similar to the effects of Novocain (subject's words). The 3-hr test was terminated at this time. First VGE detected at 63 minutes, Grade 0 from left arm, Grade 2 from left leg, Grade 2 from right arm, and Grade 3 from right leg. Last VGE record at 156 minutes with Grade 2 from left arm, Grade 3 from left leg, Grade 3 from right arm, and Grade 4 from right leg. Symptoms from right ankle and right knee resolved during descent between 8.3 and 9.0 psia. Debrief comments were that discomfort in right ankle was like a lightly twisted ankle on both sides, with later pain on top of right foot described as if something heavy had stepped on top of foot. Subject said he changed the way he did the exercise activities

to avoid involving right foot. Subject mentioned that right foot really bothered him toward the end of the test.

**Diagnosis:** Grade 3 Type I DCS

**Treatment:** One-hr GLO with follow-up consultation.

**64. Summary:** ID# 140-02, 24-year-old male, maximum Grade 4, first VGE at 40 minutes, first report at 60 minutes, study done on n = 40, crossover dependent sample statistical design.

### **Procedure 16**

**Narrative:** At 60 minutes, subject reported aches in knuckles of right hand. Reported initial pain score of 1 on a 1–10 scale. At 72 minutes and 92 minutes, subject said that right hand did not hurt as much now. At 118 minutes, subject reported a pain score of 1 for right hip, a pain that was present for the last 4–5 minutes. Described as a slight but steady ache in the front part of the right hip. Right hand discomfort was almost gone at this time. Pain score at 120 minutes was still 1 in the hip. At 155 minutes, subject reported aches in right ankle and right knee, at same pain score as right hip, a value of 1. Just 2 minutes later, at 157 minutes, subject reported just the symptom in right hip; was not aware of any other symptoms. At 3<sup>rd</sup>-hr questioning, subject assigned a pain score of 1 to right hip and right ankle. First VGE detected at 40 minutes, Grade 0 from left arm, Grade 0 from left leg, Grade 1 from right arm, and Grade 0 from right leg. Last VGE record at 169 minutes with Grade 1 from left arm, Grade 2 from left leg, Grade 2 from right arm, and Grade 4 from right leg. Symptoms in right hip and right ankle resolved during descent at 7.65 psia.

**Diagnosis:** Grade 1 Type I DCS

**Treatment:** One-hr GLO with follow-up consultation.

### **Bends 8b (prior treadmill exercise): DCS Assigned at JSC**

**65. Summary:** ID# 149-01, 40-year-old male, maximum Grade 4, first VGE at 45 minutes, first report at 108 minutes, study done on n = 41, crossover dependent sample statistical design.

### **Procedure 17**

**Narrative:** At 108 minutes, subject reported irritation and itching on the chest. During 3<sup>rd</sup> VGE measurement period, at 45 minutes into exposure, Grade 3 VGE were detected when the left leg was flexed. Grade 4 VGE were detected from left leg and right leg at 77, 92, and 108 minutes. Bubble signals were more intense at 92 and 108 minutes and were assigned a Grade 4+. Last VGE record at 108 minutes with Grade 1 from left arm, Grade 4 from left leg, Grade 3 from right arm, and Grade 4 from right leg. Between 108 and 120 minutes, subject described irritation and itching on chest. There was blue and red marbling on the right side of chest. Skin mottling was diagnosed 120 minutes into the exposure. Subject was removed through a transfer airlock at 126 minutes. Rash and mottling reduced on descent, with mild redness at site pressure.

**Diagnosis:** Type II DCS (at this time, CM by itself was also classified as Type II DCS at JSC)

**Treatment:** One-hr GLO and USN HBO TT V, and the mottling resolved before treatment ended. Follow-up consultation the next day was done.

A 40-year-old male, 80.9 kg, 174 cm, with 21% computed body fat and 26.7 BMI, participated in an altitude exposure at JSC. Subject had no previous altitude exposure as a research subject. Subject ascended to 6.5 psia for a 3 hr exposure while breathing 100% O<sub>2</sub> through a mask. Prior to the ascent, there was a brief ear and sinus check done by depressurizing the chamber atmosphere to the equivalent of 6,000 feet altitude in about 1 minutes (5,000 feet/minute). Subject breathed air during this check, which took approximately 5 minutes for all subjects to be evaluated, primarily during the repressurization back to site pressure. The medical technician exited the chamber and an ascent on air to 10 psia at 6,500 feet/minute was begun 6 minutes from the start of the initial ascent. About 2 minutes later subject donned the O<sub>2</sub> mask at 10 psia and the chamber continued the ascent to 6.5 psia at 6,500 feet/ minutes. The ascent time to 6.5 psia was 12 minutes with subject breathing 100% O<sub>2</sub> for 10 minutes. Exercise stressed the upper body since 4 minutes were spent flexing the wrist, elbow, and shoulder joints while rhythmically rotating the wheel of a bicycle ergometer against a set resistance from a standing position, 4 minutes torquing fixed bolts with either the left or right hand from a standing position, and 4 minutes of rhythmically pulling against a set resistance from a seated position. The details of these exercises are available. Finally, there was a 4 minutes period of rest and a 4 minutes period of bubble monitoring with subject asked to flex each limb in turn while in a supine position. Subject ambulated to the three exercise stations within the chamber. During the third VGE measurement period, at 45 minutes into the exposure, Grade III VGE was detected when the left leg was flexed. Grade IV VGE was detected from the left and right legs at 77, 92, and 108 minutes. The bubble signals were more intense during the 92 and 108 minutes times and were assigned a Grade IV+. Between 108 and 120 minutes subject described irritation and itching on the chest. There was blue and red marbling on the right side of the chest. Skin mottling was diagnosed 120 minutes into the exposure. Subject was removed through a transfer airlock at 126 minutes. Rash and mottling reduced on descent, with mild redness at site pressure. Subject was treated with HBO on a USN TT V, and the mottling resolved before the treatment ended.

**66. Summary:** ID# 157-01, 28-year-old female, maximum Grade 0, first report at 120 minutes a symptom she noticed at about 117 minutes, study done on n = 41, crossover dependent sample statistical design.

### **Procedure 17**

**Narrative:** At 120 minutes, during 2<sup>nd</sup>-hr questioning, subject reported dull ache in right wrist that had started about 3 minutes earlier. Reported initial pain score of 3 on a 1–10 scale that was only present while exercising. No VGE were detected at this time. Pain score decreased to 1 at 138 and 180 minutes. At 138 minutes, the dull ache was still present but reduced to pain score of 1. By end of the 3-hr test, the same dull ache in right wrist was just a little worse during the exercise. Last VGE record at 174 minutes with Grade 0 from left arm, Grade 0 from left leg, Grade 0 from right arm, and Grade 0 from right leg. No VGE were detected during the test. Mentioned she was hot, the chamber air conditioning was off. Said she was fatigued from the exercise profile. Symptoms in right wrist resolved during descent at 7.34 psia.

**Diagnosis:** Grade 1 Type I DCS

**Treatment:** Two-hr GLO with follow-up consultation.

**67. Summary:** ID# 158-01, 26-year-old male, maximum Grade 4, first VGE at 56 minutes, first report at 111 minutes a symptom he noticed minutes earlier, study done on n = 41, crossover dependent sample statistical design.

#### **Procedure 17**

**Narrative:** At 111 minutes, subject reported that left ankle hurt. Reported initial pain score of 1 on a 1–10 scale. Discomfort was noticed at the Doppler station, and decreased on walking. Subject reported a dull ache in left shoulder and a cramp in left side during deep inspiration from between 90 to 100 minutes into the test. All of these symptoms were attributed to the exercise devices, and improved during the evolution of the left ankle symptom. Pain score for the left ankle increased to 2 at 123 minutes, and was most noticeable at the Doppler station. Pain score reported to decrease to 1 by 138 minutes. Subject reported a slight pain in the left ankle at 152 minutes on a pain score of 1–2, and a very slight awareness or dull pain just below the patella on right side of left knee at less than a 1 on pain score. At 180 minutes, during final interview about symptoms, subject reported the same slight pain in left ankle during flexion of joint, but didn't notice symptom while walking. First VGE detected at 56 minutes, Grade 0 from left arm, Grade 2 from left leg, Grade 0 from right arm, and Grade 0 from right leg. Last VGE record at 168 minutes with Grade 0 from left arm, Grade 4 from left leg, Grade 0 from right arm, and Grade 0 from right leg. Symptoms in left ankle and left knee resolved during descent at 10.1 psia.

**Diagnosis:** Grade 1 Type I DCS

**Treatment:** Two-hr GLO with follow-up consultation.

**68. Summary:** ID# 164-01, 27-year-old male, maximum Grade 4, first VGE at 44 minutes, first report at 79 minutes, study done on n = 41, crossover dependent sample statistical design.

#### **Procedure 17**

**Narrative:** At 79 minutes, subject reported a mild transient dull ache in left knee. Reported initial pain score of 2 on a 1–10 scale. Pain score remained constant at 2 at 112 minutes, and then decreased to 1 at 146 minutes. At 3<sup>rd</sup>-hr questioning, subject mentioned that the left knee hurt during movement at the Doppler station; about a 2 on the pain score. Also detected mild pain in left ankle, at a pain score of 1. First VGE detected at 44 minutes, Grade 0 from left arm, Grade 4 from left leg, no measurement from the right arm, and Grade 0 from right leg. Last VGE record at 178 minutes with Grade 0 from left arm, Grade 3 from left leg, Grade 0 from right arm, and Grade 0 from right leg. Symptoms in left knee and left ankle resolved during descent at 8.1 psia.

**Diagnosis:** Grade 1 Type I DCS

**Treatment:** Two-hr GLO with follow-up consultation.

**69. Summary:** ID# 140-01, 24-year-old male, maximum Grade 4, first VGE at 20 minutes, first report at 97 minutes, study done on n = 41, crossover dependent sample statistical design.



## Procedure 17

**Narrative:** At 97 minutes, subject reported mild or slight pain in right thumb. Reported initial pain score of 1–2 on a 1–10 scale. At 2<sup>nd</sup>-hr questioning, subject reported no change in right thumb symptom. At 163 minutes, subject reported slight pain in right knee, on a pain score of 1–2. Pain was located beneath patella, with no change in symptom on flexion or extension of right leg. At 170 minutes, subject reported no pain in right thumb, no change in right knee. At 3<sup>rd</sup>-hr questioning, subject reported pain in right knee had almost gone. First VGE detected at 20 minutes, Grade 0 from left arm, Grade 0 from left leg, Grade 1 from right arm, and Grade 1 from right leg. Last VGE record at 168 minutes with Grade 0 from left arm, Grade 4 from left leg, Grade 0 from right arm, and Grade 4 from right leg. Symptoms in right knee resolved during descent at 7.65 psia.

**Diagnosis:** Grade 1 Type I DCS

**Treatment:** One-hr GLO with follow-up consultation.

**70. Summary:** ID# 139-01, 23-year-old male, maximum Grade 4, first VGE at 42 minutes, first report at 60 minutes, study done on n = 41, crossover dependent sample statistical design.

## Procedure 17

**Narrative:** At 60 minutes, subject reported discomfort in outer fingers of left hand. Did not report initial pain score on a 1–10 scale. There was no numbness, or change in sensorium. At 86 minutes, subject reported no change in discomfort of left hand. Mentioned that he became cold during ascent, but the sensation left. As it left, the first VGE began to appear and with them the discomfort in left hand began. Grade 2 VGE detected from left arm at 42 minutes, then Grade 4 at 64 minutes. No other VGE were detected in left leg, right leg, or right arm. At 98 minutes, pain diminished and there was no further numbness or change in sensorial. Last Grade 4 VGE were recorded at 84 minutes, with lesser grades detected for the duration of the test. Last VGE record at 172 minutes with Grade 1 from left arm, Grade 0 from left leg, Grade 0 from right arm, and Grade 0 from right leg. At 126 minutes, there was no pain, but still an awareness. At 138 minutes, there was no residual pain, the left hand did not hurt, but awareness was present. At 146 minutes, there was still some awareness in left hand. He still had some pain in left hand prior to descent. On descent, all symptoms in left hand cleared at 7.43 psia.

**Diagnosis:** Grade 1 Type I DCS

**Treatment:** One-hr GLO with follow-up consultation.

**71. Summary:** ID# 137-02, 24-year-old male, maximum Grade 4, first VGE at 59 minutes, first report at 120 minutes a symptom he noticed at about 105 to 110 minutes, study done on n = 41, crossover dependent sample statistical design.

## Procedure 17

**Narrative:** At 120 minutes, during 2<sup>nd</sup>-hr questioning, subject reported slight pain in left knee. Reported initial pain score of 1 on a 1–10 scale, but only during extension of the left leg. Subject relayed that pain had started about 10–15 minutes earlier. Pain score remained constant at 1 at 120 and 128 minutes. At 140 minutes, subject reported a reduction in symptom in the left knee to a 0 on the 1–10 pain score. At 3<sup>rd</sup>-hr questioning, he reported no symptoms from left knee. First VGE detected at 59 minutes, Grade 0 from left arm, Grade 4 from left leg, Grade 0 from right arm, and Grade 2 from right leg. Last VGE record at 168 minutes with Grade 0 from left arm, Grade 4 from left leg, Grade 0 from right arm, and Grade 0 from right leg. Logbook did not document whether or not subject reported if there was a change in left knee symptoms during descent. But during posttest debriefing, he mentioned that pain had disappeared on return to site pressure. He also volunteered that he experienced an extremely mild pain in his teeth, but no other details were available.

**Diagnosis:** Grade 2 Type I DCS

**Treatment:** One-hr GLO with follow-up consultation.

**72. Summary:** ID# 136-01, 26-year-old female, maximum Grade 4, first VGE at 37 minutes, first report at 60 minutes a symptom she noticed at 40 minutes, study done on n = 41, crossover dependent sample statistical design.

### **Procedure 17**

**Narrative:** At 60 minutes, during 1<sup>st</sup>-hr questioning, subject reported mild discomfort in right elbow. Reported initial pain score of 3–4 on a 1–10 scale. Subject volunteered that discomfort was present for about 20 minutes. At 87 minutes, subject reported that pain in right elbow was less than previously reported, and still a little stiff. At 120 minutes, she reported slight uncomfortable pressure in left knee. She said knee pain was detected about 16 minutes earlier. Also, pain in the right elbow was gone. At 141 minutes, left knee pain score increased to 4–5. A new right knee pain also appeared and was given a pain score of 2. She mentioned that it would be “difficult to bend knee if had to.” A decision was made to terminate test for this subject, and at 146 minutes subject was returning to site pressure via the transfer lock. First VGE detected at 37 minutes, Grade 2 from left arm, Grade 2 from left leg, Grade 2 from right arm, and Grade 4 from right leg. Last VGE record at 132 minutes with Grade 0 from left arm, Grade 4 from left leg, Grade 0 from right arm, and Grade 4 from right leg. Subject reported symptoms in both knees had cleared by 10.5 psia. During debrief, subject described elbow pain as sharp, like a sprain. Knee symptoms were described as a deeper and more throbbing pain. Pain reoccurred after 18 h. It is not clear from the logbook it reoccurring pain was in one or both knees.

**Diagnosis:** Grade 3 Type I DCS

**Treatment:** One-hr GLO and TT VI HBO with symptom resolution. Follow-up consultation the next day was done.

**73. Summary:** ID# 133-01, 31-year-old female, maximum Grade 4, first VGE at 25 minutes, first report at 137 minutes a symptom she noticed moments earlier, study done on n = 41, cross-over dependent sample statistical design.

## **Procedure 17**

**Narrative:** At 137 minutes, subject reported a sharp pain in right knee while bending right leg at the Doppler station. Reported initial pain score of 3–4 on a 1–10 scale. At 157 minutes, subject reported right knee was more tense when extending the leg. Symptom was scored as a 6 on pain score. Since extension of the leg was impaired, a decision was made to terminate the test. Initiated repressurization at 166 minutes. First VGE detected at 25 minutes, Grade 0 from left arm, Grade 0 from left leg, Grade 0 from right arm, and Grade 2 from right leg. Last VGE record at 156 minutes with Grade 0 from left arm, Grade 2 from left leg, Grade 0 from right arm, and Grade 4 from right leg. By 166 minutes during repressurization, pain in the right knee was still present at 7.9 psia. All right knee symptoms resolved during descent at 9.0 psia.

**Diagnosis:** Grade 3 Type I DCS

**Treatment:** Two-hr GLO with follow-up consultation.

**74. Summary:** ID# 31-06, 39-year-old male, maximum Grade 4, first VGE at 93 minutes, first report at 144 minutes a symptom he noticed moments earlier, study done on n = 41, crossover dependent sample statistical design.

## **Procedure 17**

**Narrative:** At 144 minutes, subject reported mild pain in right ankle and right knee, just below joint in the right knee. Reported initial pain score of 1–2 on a 1–10 scale. Pain was noticed during right leg motion at the Doppler station and was described as intermittent, not interfering with assigned exercises. Pain score remained at same low level of 1 at 180 minutes in the right knee. There was no further pain in the right ankle at the time of repressurization. First VGE detected at 93 minutes, Grade 0 from left arm, Grade 0 from left leg, Grade 0 from right arm, and Grade 3 from right leg. Last VGE record at 175 minutes with Grade 0 from left arm, Grade 1 from left leg, Grade 0 from right arm, and Grade 4 from right leg. Symptoms in right knee lessened during descent at 7.2 psia, and there was only a slight awareness at 9.7 psia. No symptoms were present at site pressure.

**Diagnosis:** Grade 1 Type I DCS

**Treatment:** One-hr GLO with follow-up consultation.

## **Bends 9a (ambulatory control): DCS Assigned at JSC**

**75. Summary:** ID# 170-01, 33-year-old female, maximum Grade 4, first VGE at 173 minutes, first report at 179 minutes, study done on n = 24, crossover dependent sample statistical design.

## **Procedure 18**

**Narrative:** At 179 minutes, during 3<sup>rd</sup>-hr questioning, subject reported pain in left leg and left thigh, but no pain in left knee. Reported initial pain score of 5 on a 1–10 scale. Pain was described as not radiating. Pain score decreased to 4 at 190 minutes, and the test was over so descent began. First and last VGE detected at 173 minutes, Grade 0 from left arm, Grade 3 from left leg, Grade 0 from right arm, and Grade 4 from right leg. Symptom pain score intensity in left leg decreased to 1 at 10.1 psia; there were no symptoms in left leg at 12.2 psia, nor any residual symptoms at site pressure. VGE still detected after test at site pressure. VGE at 219 minutes was Grade 0 from left arm, Grade 1 from left leg, Grade 0 from right arm, and Grade 2 from right leg. During debrief, done with subject breathing 100% O<sub>2</sub>, symptoms were described as pain in left leg in the thigh and calf area, not radiating, not related to the knee joint, nor did it interfere with the exercise activity. Since the test was over and descent started approximately 12 minutes after the first report, it was not possible to follow the evolution of symptoms.

**Diagnosis:** Grade 2 Type I DCS

**Treatment:** Two-hr GLO, medical observation for 12 h with follow-up consultation.

### **Bends 9b (adynamic): DCS Assigned at JSC**

**76. Summary:** ID# 130-03, 28-year-old male, maximum Grade 3, first VGE at 52 minutes, first report after test, during the later part of the 3-hr altitude exposure, study done on n = 23, crossover dependent sample statistical design.

#### **Procedure 19**

**Narrative:** Subject did not report symptoms during test. During debrief, he mentioned mild pain in left knee during later part of altitude exposure. Pain resolved during return to site pressure. A review of his Questionnaire on Post-Exposure Symptoms also uncovered a comment that left hip joint also experienced pain along with left knee. He wrote that he experienced a cold sweat from 10.1 psia on down to site pressure. He also experienced slight fatigue and weakness in the legs and lower back after standing up. Recall that this subject had been bed rested for the about 4 days, which included the time at 6.5 psia. First VGE detected at 52 minutes, Grade 1 from left arm, Grade 3 from left leg, Grade 1 from right arm, and Grade 0 from right leg. Last VGE record at 181 minutes with Grade 0 from left arm, Grade 1 from left leg, Grade 1 from right arm, and Grade 2 from right leg. Subject did not report if there was a change in symptoms during descent.

**Diagnosis:** Grade 1 Type I DCS

**Treatment:** One-hr GLO with follow-up consultation.

**77. Summary:** ID# 182-01, 52-year-old male, maximum Grade (see explanation below), first VGE at (see explanation below), first report at 113 minutes, study done on n = 23, crossover dependent sample statistical design.

#### **Procedure 19**

**Narrative:** At 113 minutes, subject reported itching and burning across the chest and axilla. Reported initial pain score of 2 on a 1–10 scale. Pain score was not reported at 136, 148, or 180

minutes into the test. Last VGE record at 179 minutes with Grade 0 from left arm, Grade 0 from left leg, Grade 0 from right arm, and Grade 0 from right leg. The MO suspected contact dermatitis. At 2<sup>nd</sup>-hr questioning, subject reported no problems other than the mild skin irritation. At 136 minutes, the DT reported an increased size of redness on the abdomen. Subject no longer reported itching, but reported that areas felt hot. All agreed to monitor subject closely, but to continue the test. At 148 minutes, the DT reported that the sizes of the patches had increased on the abdomen, with whitening of certain areas. No bubbles were detected from a precordial position using a 2-mHz Doppler probe; and since symptoms were limited to slight burning, the decision was made to finish the test. Best diagnosis at the time was contact dermatitis. At 3<sup>rd</sup>- (and last) hr questioning, subject reported that skin irritation around stomach was no worse than earlier. Subject did not report if there was a change in skin symptoms during descent. At site pressure, 189 minutes from start of exercise at 6.5 psia, the DT reported that there was no change in the skin colors. Subject was allowed to remove his O<sub>2</sub> mask. Subject had minimal mottling on the return to site pressure. He also experienced postural hypotension and dizziness on standing, which persisted after he left the chamber area.

**Diagnosis:** Type II DCS (at this time, CM by itself was also classified as Type II DCS at JSC)

**Treatment:** USN HBO TT V about 4.5 h after return to site pressure, at which time a rash was still evident. Treatment lasted 90 minutes, with no extensions since dizziness was judged to have diminished. Subject was held for observation through the night. At 21:00, the rash was still evident. At 06:30 the following day, the rash was reported as almost cleared on the lower abdomen, and greatly diminished in the left axilla. Postural hypotension confounds a proper characterization of DCS since prolonged bed rest was part of the study design. Subject displayed a Doppler blood flow signal during the test that differed from that normally encountered in hypobaric/hyperbaric decompressions. Normally, the presence of individual gas bubbles can be heard in the flow signal; but here, individual bubble signals were absent. Instead, when limb movement maneuvers occurred, the intensity of flow sound increased. Our opinion is that this is indicative of an increased number of scattering sites; the absence of individual, audible bubbles would indicate that these were microbubbles. Subject did have a PFO, with positive indication at rest.

A 52-year-old male, 80.6 kg, 179 cm, with 21% computed body fat and 25 BMI, participated in an altitude exposure at JSC. Subject had no previous altitude exposure as a research subject. Subject ascended to 6.5 psia for a 3 hr exposure while breathing 100% O<sub>2</sub> through a mask. Prior to the ascent, there was a brief ear and sinus check done by depressurizing the chamber atmosphere to the equivalent of 6,000 feet altitude in about 1 minutes (5,000 feet/minutes). The ascent time to 6.5 psia was 12 minutes with subject breathing 100% O<sub>2</sub> for 10 minutes. Subject was under strict bed rest conditions for three days prior to the ascent to simulate adaptation to microgravity. Subject stayed in a supine position during the altitude exposure. Exercise stressed the upper body, since 4 minutes were spent flexing the wrist, elbow, and shoulder joints while rhythmically rotating the wheel of an arm ergometer against a set resistance from a supine, 4 minutes torquing fixed bolts with either the left or right hand from a supine position, and 4 minutes of rhythmically pulling against a set resistance from a supine position. The details of these exercises are available. Finally, there was a 4 minutes period of rest and a 4 minutes period of bubble monitoring with subject asked to flex each limb in turn while in a supine position. Subject reported itching and burning across the chest (2 out of 10 from a pain scale) and axilla at 113 minutes into the exposure. The MO suspected contact dermatitis. At the seconds hr questioning period subject reported no problems other than the mild skin irritation. At 136 minutes the DT reported an increased size of the redness on the abdomen. Subject no longer reported itching, but reported that the areas felt hot. All agreed to monitor subject closely, but to continue the test. At 148 minutes the DT reported that the sizes of the patches had increased on the abdomen, with whitening of certain areas. No bubbles were detected from a precordial position using a 2 mHz Doppler probe, and since the symptoms were limited to slight burning the decision was made to finish the test. However, subject displayed a Doppler blood flow signal during the test that was different from that normally encountered in hypo- or hyperbaric decompressions. Normally, the

presence of individual gas bubbles can be heard in the flow signal, but in this case, individual bubble signals were absent. Instead, when the limb movement maneuvers occurred, the intensity of the flow sound increased. Our opinion is that this is indicative of an increased number of scattering sites; the absence of individual, audible bubbles would indicate that these were microbubbles. The best diagnosis at the time was still contact dermatitis. At the third (and last) hr questioning period subject reported that the skin irritation around the stomach was no worse than earlier. At site pressure, 189 minutes from start of exercise at 6.5 psia, the DT reported that there was no change in the skin colors. Subject was allowed to remove his O<sub>2</sub> mask. A series of photographs were taken of the torso following the return to site pressure (exact time is unavailable). The posttest comments in the logbook stated that subject had minimal mottling on the return to site pressure. Subject also experienced postural hypotension and dizziness on standing, and it persisted after he left the chamber area. A decision was made to treat subject on a USN TT V about 4.5 hr after the return to site pressure, at which time a rash was still evident. The treatment lasted 90 minutes, with no extensions since the dizziness was judged to have diminished. Subject was held for observation through the night. At 9:00 p.m. the rash was still evident. At 6:30 a.m. the following day, the rash was reported as almost cleared on the lower abdomen, and greatly diminished in the left axilla. The postural hypotension confounds a proper characterization of DCS since prolonged bed rest was part of the study design.



### **Bends 9c (ambulatory control): DCS Assigned at JSC**

**78. Summary:** ID# 202-01, 40-year-old female, maximum Grade 4, first VGE at 38 minutes, first report at 114 minutes a symptom she noticed at about 94 minutes, study done on n = 11, crossover dependent sample statistical design.

#### **Procedure 20**

**Narrative:** At 114 minutes, subject reported persistent pain in left knee. Reported initial pain score of 3 on a 1–10 scale. Symptom had appeared about 20 minutes earlier and was now feeling better and never interfered with exercise activities. Pain score remained constant at 3 at 180 minutes, but became worse while standing. At 140 minutes, subject reported that pain in the left knee

felt better while standing (2–3 score), and assigned it a score of 3 while sitting, but still not interfering with exercise activities. At 152 minutes, subject reported pain in left knee was much reduced; a score of 1 or lower. During the 3<sup>rd</sup>-hr questioning, subject reported a pain score 1 for left knee, and a new pain or sensation at pain score 1 in left ankle. First VGE detected at 38 minutes, Grade 2 from left arm, Grade 4 from left leg, Grade 2 from right arm, and Grade 4 from right leg. Last VGE record at 174 minutes with Grade 3 from left arm, Grade 4 from left leg, Grade 3 from right arm, and Grade 3 from right leg. Symptoms resolved during descent in left knee at 5.0 psia and in left ankle at 5.8 psia.

**Diagnosis:** Grade 2 Type I DCS

**Treatment:** One-hr GLO with follow-up consultation.

**79. Summary:** ID# 204-01, 36-year-old male, maximum Grade 4, first VGE at 47 minutes, first report at 82 minutes a symptom he noticed at 80 minutes, study done on n = 11, crossover dependent sample statistical design.

### **Procedure 20**

**Narrative:** At 82 minutes, subject reported pain in right ankle. Reported initial pain score of 1 on a 1–10 scale. He reported that pain started 2 minutes earlier, and was more noticeable during movement of ankle at the VGE monitoring station. At 87 minutes, subject reported pain in right ankle was gone. At 157 minutes, subject reported pain in right knee had started about 2 minutes earlier, but was not interfering with the exercise activities. Pain was constant, on a score of 2–3. No symptoms from right ankle. Pain score was constant at 2–3 just prior to descent at 180 minutes. First VGE detected at 47 minutes, Grade 0 from left arm, Grade 3 from left leg, Grade 3 from right arm, and Grade 4 from right leg. Last VGE record at 173 minutes with Grade 3 from left arm, Grade 3 from left leg, Grade 3 from right arm, and Grade 3 from right leg. Symptoms resolved in right knee during descent at 8.6 psia.

**Diagnosis:** Grade 2 Type I DCS

**Treatment:** Two-hr GLO with follow-up consultation.

**80. Summary:** ID# 207-01, 31-year-old male, maximum Grade 4, first VGE at 62 minutes, first report at 165 minutes, study done on n = 11, crossover dependent sample statistical design.

### **Procedure 20**

**Narrative:** At 165 minutes, subject reported minor pain in left knee. Did not provide initial pain score on a 1–10 scale. Pain was continuous, but did not interfere with exercise activities. First VGE detected at 62 minutes, Grade 1 from left arm, Grade 4 from left leg, Grade 1 from right arm, and Grade 4 from right leg. Last VGE record at 166 minutes with Grade 3 from left arm, Grade 4 from left leg, Grade 3 from right arm, and Grade 3 from right leg. Symptoms in left knee resolved during descent at 10.2 psia. During debrief, subject mentioned that he had a transient symptom in right knee that he did not report during the test.

**Diagnosis:** Grade 1 Type I DCS

**Treatment:** One-hr GLO with follow-up consultation.

## **Bends 10: DCS Assigned at JSC**

**81. Summary:** ID# 192-01, 31-year-old male, maximum Grade 4, first VGE at 20 minutes, first report at 158 minutes a symptom he noticed moments earlier, study done on n = 19, independent sample statistical design.

### **Procedure 21**

**Narrative:** At 158 minutes, subject reported mild joint awareness in left elbow. Reported initial pain score of 1 on a 1–10 scale. He noticed pain during the previous Doppler monitoring period. At 178 minutes, there was no pain. Bubbles first detected Grade 1 from right leg at 20 minutes, which increased in grade and stayed at Grade 3 during the last monitoring periods. At the same time, left arm, right arm, and left leg contributed Grade 1 and 2 from about 55 minutes for the duration of the test. First VGE detected at 20 minutes, Grade 0 from left arm, Grade 0 from left leg, Grade 0 from right arm, and Grade 1 from right leg. Last VGE record at 165 minutes with Grade 2 from left arm, Grade 1 from left leg, Grade 2 from right arm, and Grade 3 from right leg. There were no symptoms prior to descent; symptoms resolved at the test altitude of 10.1 psia.

**Diagnosis:** Grade 1 Type I DCS

**Treatment:** One-hr GLO with follow-up consultation.

## **Bends 11a: DCS Assigned at JSC**

**82. Summary:** ID# 215-01, 25-year-old male, maximum Grade 3, first VGE at 96 minutes, first report at 145 minutes a symptom he noticed at 144 minutes, study done on n = 28, independent sample statistical design.

### **Procedure 22**

**Narrative:** At 145 minutes, subject reported mild pain under the patella and to the left of right knee. Reported initial pain score of 1 on a 1–10 scale. He noticed symptom 1 minute earlier. First VGE detected at 96 minutes, Grade 2 from left arm, Grade 2 from left leg, Grade 2 from right arm, and Grade 3 from right leg. Last VGE record at 133 minutes with Grade 2 from left arm, Grade 2 from left leg, Grade 2 from right arm, and Grade 3 from right leg. After 96 minutes, subject had Grade 3 VGE from right leg and Grades 1 and 2 assigned to the other 3 limbs. At the time of symptom report at 145 minutes, VGE grade was still 3 from right leg. Subject suggested, and the MO concurred, that he should stand and flex right leg to further evaluate this mild pain. Subject reported that mild pain had now abated and was not present once he returned to his seat. By this time, subject had been seated for 335 minutes. Decision was made by MO to abort the test. Entire test was terminated at 148 minutes into the 240 minutes test. There were no symptoms prior to descent; symptoms resolved at the test altitude of 4.3 psia.



**Diagnosis:** Grade 1 Type I DCS

**Treatment:** Two-hr GLO with follow-up consultation.

**83. Summary:** ID# 228-01, 40-year-old female, maximum Grade 4, first VGE at 101 minutes, first report at 153 minutes, study done on n = 28, independent sample statistical design.

#### **Procedure 22**

**Narrative:** At 153 minutes, subject reported dull pain under and inside right patella. Pain did not increase on extension of right leg. At 101 minutes into test, Grade 2 VGE detected from left leg. First VGE detected at 101 minutes, Grade 0 from left arm, Grade 0 from left leg, Grade 0 from right arm, and Grade 2 from right leg. Last VGE record at 153 minutes with Grade 1 from left arm, Grade 3 from left leg, Grade 1 from right arm, and Grade 4 from right leg. At 117 minutes, VGE were Grade 2 from left leg and Grade 3 from right leg. At 137 minutes, VGE were Grade 4 from left leg and Grade 4+ from right leg. Entire test was terminated at approximately 160 minutes into the 240-minute test. Pain in right knee resolved during descent at 6.75 psia. Grade 3 VGE detected from right leg at 175 minutes while at site pressure, and Grade 0 from all limbs by 194 minutes.

**Diagnosis:** Grade 1 Type I DCS

**Treatment:** Two-hr GLO with follow-up consultation.

**84. Summary:** ID# 234-01, 31-year-old female, maximum Grade 4, first VGE at 32 minutes, first report at 48 minutes, study done on n = 28, independent sample statistical design.

**Procedure 22.** Same as Procedure 22 except this subject had a problem with a right ear block after the 6000 ft ear and sinus check before the final ascent to 4.3 psia that effectively added 24 minutes to the 3-hr PB.

**Narrative:** At 48 minutes, subject reported a dull ache in right wrist that was noticeable without exercise. At 54 minutes, subject said it felt better after MO questioning, and MO continued test with instructions for subject to keep the MO informed of any changes in right wrist. At 32 minutes, Grade 2 VGE were detected from left leg and right leg and Grade 4 from right arm. At 51 minutes, Grade 3 VGE from left arm and right leg, with Grade 4 from left leg and right arm. At 68 minutes, all limbs showed Grade 4 VGE. Last VGE record at 68 minutes with Grade 4 from left arm, Grade 4 from left leg, Grade 4 from right arm, and Grade 4 from right leg. At 1<sup>st</sup>-hr questioning, subject said there was still discomfort in right wrist without activity, and it did not feel worse with exercise. She said this discomfort was not felt during the pre-test exercise practice in the Environmental Lab. At 72 minutes, during Doppler monitoring, subject reported pain in left wrist. It was same pain as in right wrist. The entire test was terminated at 76 minutes into the 240-minute test. Pain in right wrist resolved during descent at 4.56 psia and from left wrist at 4.99 psia.

**Diagnosis:** Grade 1 Type I DCS

**Treatment:** Two-hr GLO with follow-up consultation.

## Phase I PRP: DCS Assigned at Duke

**85. Summary:** ID# D980113C, 23-year-old female, maximum Grade 3, first VGE at 75 minutes, first report at 76 minutes, study done on n = 47, independent sample statistical design.

### Procedure 23

**Narrative:** At 76 minutes, subject reported soreness in right ankle, which progressed over ensuing 10 minutes to a constant deep ache. At 86 minutes, she reported pain score of 3 on a 1–10 scale. She had no other problems, but could be observed to favor her right leg during the Pull Station exercises. At 94 minutes, she reported a persistent “weird aching feeling” in left ankle, joined by new complaint of pain in bottom of left foot, all on a 3 pain score. Preparations were made for subject lockout. Lockout preparations took about 15 minutes (about 110 minutes elapsed time from start of test), by which time subject noted onset of right knee pain. During move to chamber lock, subject experienced a bout of lightheadedness, probably orthostatic. First VGE detected at 75 minutes, Grade 2 from right arm, Grade 2 from left arm, Grade 3 from left leg, and Grade 3 from right leg. Last VGE record at 104 minutes with Grade 0 from right arm, Grade 2 from left arm, Grade 2 from left leg, and Grade 3 from right leg. All symptoms in both ankles and right knee resolved on descent.

**Diagnosis:** Type I DCS

**Treatment:** Prophylactic USN HBO TT V was given. Follow-up consultation the next day was done.

**86. Summary:** ID# D980120B, 46-year-old male, maximum Grade 4, first VGE at 16 minutes, first report at 113 minutes, study done on n = 47, independent sample statistical design.

### Procedure 23

**Narrative:** At 113 minutes, subject reported pain or ache in left knee that differed from any he had before in his left knee. Reported initial pain score of 2 on a 1–10 scale. By 181 minutes, the pain was gone and the exposure had finished uneventfully. First VGE detected at 16 minutes, Grade 2 from right arm, Grade 2 from left arm, Grade 3 from left leg, and Grade 2 from right leg. VGE detected at time of the left knee report at 113 minutes was Grade 2 from right arm, Grade 1 from left arm, Grade 4 from left leg, and Grade 2 from right leg. The last complete VGE record at 197 minutes with Grade 2 from right arm, Grade 3 from left arm, Grade 4 from left leg, and Grade 2 from right leg. Four days later, subject reported numbness in left foot at base of toes, which resolved spontaneously within a few h. Seven days postflight the numbness in left foot at base of toes returned. No objective abnormality was found on examination, but tissues deep to the skin at the base of toes on left foot felt numb. Hyperbaric treatment was initiated.

**Diagnosis:** Type I DCS

**Treatment:** USN HBO TT VI with full resolution of symptoms in last O<sub>2</sub> period. Consulting MO “finds it difficult to believe these purely subjective features are due to the same (left knee)

disorder, with onset 4 days after the trial. However, I cannot otherwise account for his complaint.” Follow-up consultation the next day was done.

**87. Summary:** ID# D980203B, 22-year-old female, maximum Grade 1, first VGE at 74 minutes, first report at 111 minutes, study done on n = 47, independent sample statistical design.

### **Procedure 23**

**Narrative:** At 111 minutes, subject reported twitching on lateral surface of left calf. Pinprick sensation was evaluated during this time with no difference of sensation reported over involved area. First VGE detected at 74 minutes, Grade 0 from right arm, Grade 0 from left arm, Grade 1 from left leg, and Grade 0 from right leg. Last VGE record at 242 minutes with Grade 0 from right arm, Grade 0 from left arm, Grade 0 from left leg, and Grade 0 from right leg. Symptom resolved by 180 minutes. There were no symptoms prior to descent; symptoms resolved at the test altitude of 4.3 psia. With return to surface, subject had no symptoms at rest; but upon rising from semi-supine position, she noticed a very mild discomfort in lateral, distal aspect of her right thigh, which she reported was apparent only while walking when right foot struck the floor. Subject was in mid-menstrual cycle and reported taking Loestrin. At 505 minutes, subject returned to lab after having reported being awakened from a nap by pain in right wrist at 21:30. On interview at 23:20, she noted that in addition to right wrist pain, she had also experienced transient numbness of the ends of fingers on right hand, which had resolved. Also noted that right hand felt colder than left hand, a sensation that persisted into the interview. Original discomfort in right thigh was unchanged. Hyperbaric treatment was initiated.

**Diagnosis:** Type I DCS

**Treatment:** USN HBO TT VI and both wrist and residual leg pain completely resolved within about 5 minutes of reaching depth. Compression was extremely slow (approximately 12 minutes) due to problems equalizing ears. Follow-up consultation the next day was done.

**88. Summary:** ID# D980210A, 21-year-old female, maximum Grade 0, first report at 164 minutes, study done on n = 47, independent sample statistical design.

### **Procedure 23**

**Narrative:** At 164 minutes, subject reported a headache and feeling hot during exposure. Reported initial pain score of 2 on a 1–10 scale. No VGE were detected in this subject. Last VGE record at 228 minutes with Grade 0 from right arm, Grade 0 from left arm, Grade 0 from left leg, and Grade 0 from right leg. Subject completed exposure. At 1,649 minutes from start of altitude exposure (17:00 the day after the exposure), subject called FGHL (2/11/98) with complaint of intermittent pain in right elbow and right wrist throughout the day. Noted that on awakening in the morning (day immediately following the EVA day), she had some tingling in her right wrist and forearm, which quickly resolved. She remained unaware of any significant wrist or elbow pain until later in the day when, with the performance of manual tasks, she noted stiffness in both her right wrist and elbow that was worst immediately following use of her hands and improved with rest. Subject was symptom free and without complaint at 17:00, the time of the 2/11/98 call.

Subject elected to wait until following morning to report to FGHL, when she was otherwise already scheduled to participate in another research study. On 2/12/98, subject reported to FGHL in morning. On physical examination, subject was found to be entirely within normal limits, specifically normal neurological to light touch, pinprick, normal reflexes and normal strength. However, subject complained of mild intermittent discomfort in right wrist and right elbow. She added that she would occasionally experience light twinges of tingling in her right hand, that her right hand did not feel normal (although no sensory deficit), and that she generally did not feel normal. Hyperbaric treatment was initiated.

**Diagnosis:** Type I DCS

**Treatment:** USN HBO TT VI and on arrival at 60 fsw [feet seawater] while breathing 100% O<sub>2</sub> subject reported full relief of joint pain, but still-persistent abnormal feeling in right hand. Follow-up consultation the next day was done.

**89. Summary:** ID# D980303B, 27-year-old female, maximum Grade 3, first VGE at 49 minutes, first report at 134 minutes, study done on n = 47, independent sample statistical design.

### **Procedure 23**

**Narrative:** At 134 minutes, subject reported onset of pain in dorsum of left wrist. Reported initial pain score of 3 on a 1–10 scale. Pain worsened to a level 4 with distraction force (pulling) and improved to a level 2 with compressive force on wrist. Pain score improved spontaneously to 2.5 after about 30 minutes of continued activity, but never completely resolved. Pain improved by 163 minutes but never completely resolved. Evaluation by inside tender demonstrated no abnormal pinprick sensation, and no visible cutaneous changes were evident. Subject was otherwise symptom-free. Persistence of symptoms in left wrist motivated a decision to remove subject from the chamber at 211 minutes. First VGE detected at 49 minutes, Grade 1 from right arm, Grade 1 from left arm, Grade 2 from left leg, and Grade 2 from right leg. Last VGE record at 186 minutes with Grade 0 from right arm, Grade 0 from left arm, Grade 0 from left leg, and Grade 0 from right leg. During descent at 10.11 psia, subject reported distal migration of pain to dorsum of left hand, still at a 2.5 pain score. At 12.69 psia, subject reported tingling in 4<sup>th</sup> and 5<sup>th</sup> digits of left hand. During evaluation at site pressure while subject on 100% O<sub>2</sub>, subject reported additional onset of left thumb pain, but improved digit tingling and resolution of left wrist and hand pain. Hyperbaric treatment initiated.

**Diagnosis:** Type I DCS

**Treatment:** Posttest O<sub>2</sub> until USN HBO TT VI started. All remaining symptoms resolved. Subject returned for reevaluation 8-hr post USN TT VI reporting residual tenderness along ulnar aspect of left forearm, wrist, and 5<sup>th</sup> digit. On examination, tenderness was found to worsen with palpation and resisted motion at the wrist. Otherwise subject without complaint of recurrent neurological symptoms in fingers, hand, or wrist. New complaints consistent with mild tendonitis from EVA exercises. Subject instructed to begin course of nonsteroidal anti-inflammatory medication for treatment. On follow-up 5 days later (3/9/98), mild residual tendonitis persisted but was improving. Subject, having returned to normal activity without residual deficit, reported being pleased with treatment course and recovery.

## **Phase I PRP: DCS Assigned at Hermann**

**90. Summary:** ID# H980219A, 45-year-old male, maximum Grade 4, first VGE at 108 minutes, first report at 110 minutes, study done on n = 47, independent sample statistical design.

### **Procedure 23**

**Narrative:** At 110 minutes, subject reported pain on left side of left knee. Reported initial pain score of 3 on a 1–10 scale, and pain was constant. Maximum VGE grades were 1 from right arm, 1 from left arm, 4 from left leg, and 3 from right leg. First VGE detected at 108 minutes, Grade 1 from right arm, Grade 1 from left arm, Grade 4 from left leg, and Grade 3 from right leg. Last VGE record at 228 minutes with Grade 0 from right arm, Grade 0 from left arm, Grade 2 from left leg, and Grade 3 from right leg. Pain report at 119 minutes into test was constant and mild at 2 or 3 on 10-point scale. Subject reported that pain felt like it was in the joint and it did not interfere with performance. Pain also continued at rest. At 128 minutes, pain was constant at a level of 2. At 196 minutes, subject described pain as awareness during the exercise and a 0.5 on pain score in left knee. Subject remained at 4.3 psia for the duration of the 4-hr test. Sometime during the descent to site pressure, awareness in left knee was completely gone.

**Diagnosis:** Type I DCS. MO diagnosed DCS at 119 minutes, but for unknown reasons allowed the test to continue to the end.

**Treatment:** One-hr GLO with follow-up consultation.

**91. Summary:** ID# H980226A, 28-year-old male, maximum Grade 3, first VGE at 76 minutes, first report at 144 minutes a symptom he noticed moments earlier, study done on n = 47, independent sample statistical design.

### **Procedure 23**

**Narrative:** At 144 minutes, subject reported pain on lateral-left ankle and under the patella of left knee. Reported initial pain score of 1 on a 1–10 scale. Pain was intermittent at the beginning but within 1 or 2 minutes became constant. Pain in left knee was described as intermittent at first and then became more constant under the patella. Pain seemed to have started shortly after the extension of left leg upon Doppler monitoring. First VGE detected at 76 minutes, Grade 0 from right arm, Grade 0 from left arm, Grade 3 from left leg, and Grade 2 from right leg. Last VGE record at 144 minutes with Grade 2 from right arm, Grade 2 from left arm, Grade 3 from left leg, and Grade 3 from right leg. Subject was locked out. Symptoms in left knee and left ankle cleared at 7.2 psi.

**Diagnosis:** Type I DCS

**Treatment:** One-hr GLO with follow-up consultation.

**92. Summary:** ID# H980310A, 26-year-old male, maximum Grade 3, first VGE at 76 minutes, first report at 76 minutes, study done on n = 47, independent sample statistical design.

## Procedure 23

**Narrative:** At 76 minutes, subject reported continuous pain on external side of left ankle. Reported initial pain score of 3 on a 1–10 scale. Subject had Grade 3 VGE from left leg at this time. First VGE detected at 77 minutes, Grade 0 from right arm, Grade 0 from left arm, Grade 1 from left leg, and Grade 2 from right leg. Last VGE record at 92 minutes with Grade 1 from right arm, Grade 1 from left arm, Grade 3 from left leg, and Grade 3 from right leg. Subject wanted to continue exercises and, at 92 minutes, reported pain in right ankle. Subject was locked out. All symptoms in both ankles cleared at 5.2 psi.

**Diagnosis:** Type I DCS. MO diagnosed DCS in left ankle after 76 minutes but subject wanted to continue test. The MO ended test after the second report of pain in right ankle at 92 minutes.

**Treatment:** One-hr GLO with follow-up consultation.

**93. Summary:** ID# H980324B, 29-year-old female, maximum Grade 3, first VGE at 76 minutes, first report at 76 minutes, study done on n = 47, independent sample statistical design.

## Procedure 23

**Narrative:** At 76 minutes, subject reported a feeling of tingling (like an itch) on both lower extremities. Subject had Grade 2 VGE from left leg at this time. First VGE detected at 77 minutes, Grade 0 from right arm, Grade 0 from left arm, Grade 2 from left leg, and Grade 0 from right leg. Last VGE record at 160 minutes with Grade 1 from right arm, Grade 3 from left arm, Grade 3 from left leg, and Grade 3 from right leg. Subject wanted to continue the test and, at 108 minutes, subject also reported tingling in left arm as well as original sensation in lower extremities. At 128 minutes, subject had Grade 3 VGE from left leg and the tingling sensation on both legs and left arm was becoming more intense. Sensation had expanded to both thighs. At 144 minutes, sensation became more intense on outer thigh. At 160 minutes, subject had Grade 3 VGE in both legs and said that tingling had expanded to the lower back area and the hips. Subject was locked out at 160 minutes, and all tingling symptoms resolved at 8.0 psi with some residual awareness on left thigh. During the MO interview after the test, subject reported that she had left knee and hip pain on a pain score of 3–4. At the end of postflight PB, subject was symptom free and was discharged by the on-call MO. NOTE: The 10-minute PB exercise was too hard for subject to keep up with her legs. Resistance was decreased from the prescribed 133 to 83 for 4 minutes then back to 133. Target heart rate peaked at 189.

**Diagnosis:** Type I DCS

**Treatment:** One-hr GLO with follow-up consultation.

## Phase III PRP: DCS Assigned at Duke

**94. Summary:** ID# D980630B, 29-year-old female, maximum Grade 0, first report at 52 minutes, study done on n = 10, independent sample statistical design.

## Procedure 25

**Narrative:** At 52 minutes, subject reported a headache on right anterior side of skull. Reported initial pain score of 1 on a 1–10 scale. Reported bilateral sinus pain at 67 minutes. At 101 minutes, subject reported right shoulder ache while exercising. At 142 minutes, right shoulder pain was reported to have increased with a pain score of 1 assigned to it, and was present during exercise and rest. At 137 minutes, subject reported headache was at a pain score of 1.5 severity, and her eyes were dry. At 192 minutes, right shoulder pain had increased to a pain score of 2 and had become constant to persist throughout exercise and rest. Subject had no VGE. Last VGE record at 203 minutes with Grade 0 from right arm, Grade 0 from left arm, Grade 0 from left leg, and Grade 0 from right leg. Subject was locked out at 207 minutes with complete relief of shoulder symptoms. Subject experienced difficulty clearing her ears and sustained bilateral ear barotraumas. NOTE: Subject had a history of shoulder dislocation (side not specified) in childhood. Sacroiliac pain treated by chiropractor within 12 months preceding altitude test.

**Diagnosis:** Type I DCS. Ear examination revealed moderately injected tympanic membranes with some hemorrhaging.

**Treatment:** Two-hr GLO with follow-up consultation.

**95. Summary:** ID# D980714C, 42-year-old male, maximum Grade 4, first VGE at 105 minutes, first report at 143 minutes, study done on n = 10, independent sample statistical design.

## Procedure 25

**Narrative:** At 143 minutes, subject reported itching on arms and legs (right side from an earlier e-mail). At 149 minutes, subject reported a “numb” feeling from heel to toe of right foot. At 169 minutes, subject reported being “numb all over”. Shortly after this report, subject reported right knee pain. First VGE detected at 105 minutes, Grade 0 from right arm, Grade 0 from left arm, Grade 1 from left leg, and Grade 0 from right leg. Last VGE record at 156 minutes with Grade 0 from right arm, Grade 1 from left arm, Grade 4 from left leg, and Grade 4 from right leg. Subject was returned to site pressure at this time, but symptoms persisted at site pressure.

**Diagnosis:** Type II DCS

**Treatment:** Multiple HBO treatments. Initial intermittent symptoms of right arm and right leg numbness progressed to include right-sided sensorimotor changes, right knee pain, unsteady gait, visual scotomata, disorientation, and confusion. These symptoms responded to a full USN TT VI, but recurred after surfacing. A second recompression treatment was performed, on a TT VI with Catalina Extensions (more 100% O<sub>2</sub> than a standard TT VI). Following this, patient was admitted to hospital. His condition markedly improved, with minimal neurological findings remaining. Brain MRI [magnetic resonance imaging] was normal. Bubble contrast echocardiogram showed PFO at rest. Follow-up hyperbaric treatments were administered during next 2 days, and follow-up neurological examinations were normal.

MO Consult Note, Time of Consult: 15:20 July 14, 1998

Reason for Consult: Decompression Illness resulting from NASA Study.

**HISTORY OF PRESENT ILLNESS:** The patient is a 42 year old white Caucasian male who was participating in a physiology experiment today in the Duke Hyperbaric Chamber on 14 July 1998. His first symptom was itching on the arms and legs that began 143 minutes (clock time 15:12) after arrival at 30,000 feet (4.3 psia). Prior to ascent he had breathed 100% O<sub>2</sub> for 2 hr and continued breathing 100% O<sub>2</sub> while at altitude. At altitude, the patient did intermittent mild arm and leg exercise according to the experimental protocol. 6 minutes after the onset of itching he noted a “numb” feeling from heel to toe. Over the course of the next 10 minutes the symptoms did not progress and became intermittent for a time. It was decided to observe closely but continue the protocol so long as symptoms continued to resolve. At this point the diagnosis of altitude DCS had not been made since transient sensory changes in extremities on this protocol are not uncommon. Approximately 26 minutes after the first symptom onset he reported being “numb all over.” He said it came as a “flash” but did not persist. Shortly after that, right knee pain also developed. At this point (30 minutes after the initial itching) the diagnosis and DCS was made and preparations to return the patient to 1 ATA were begun immediately. As preparations were underway the leg numbness returned and he noted spots and lines in front of his eyes. Twelve minutes later he was at 1 ATA. Upon entering the transfer chamber for return to 1 ATA, he noted he was unsteady and actually fell down at one point. Upon reaching 1 ATA the patient was taken to the physiology laboratory where he was seated. The patient appeared dazed and did not respond to verbal queries as if he couldn’t hear. But after finally getting his attention, it was determined that his hearing was normal and that he was oriented to person, place, and time.

**PHYSICAL EXAMINATION:** The patient appeared mildly confused and displayed a very flat affect but answered all questions correctly during examination. His speech seemed slow and deliberate. He was oriented to person, place, and time. Strength and cranial nerves were normal. There was decreased sensation to pinprick in the right arm compared to the left. He complained his right arm and leg felt numb. Finger-to-nose was slow and deliberate without past pointing. His normal Rhomberg showed significant unsteadiness. He could not perform tandem gait and his sharpened Rhomberg was less than 2 seconds. He was administered the same neurobehavioral cognitive exam that we used for evaluating CO patients and this was within normal limits. Proprioception was tested by moving the great toe up and down. He was consistently correct on the left but occasionally incorrect on the right. He was at 1 ATA approximately 50 minutes from the time he exited the altitude chamber until the time he was recompressed and during that time he said that he felt “less out of it” and was feeling a little better. During his time at 1 ATA while being examined he breathed air.

**IMPRESSION:** Decompression sickness due to altitude exposure.

**DISPOSITION:** Compressed to 60 feet, execute USN TT VI.

**TREATMENT PROGRESS:** Treatment Table VI was started at 16:47 on 15 July 1998, 50 minutes after leaving the altitude chamber. After the 1st O<sub>2</sub> period at 60 feet, there were no changes in his gait or his Rhomberg. The patient now noted some scintillating scotoma in both eyes. After the 2nd O<sub>2</sub> breathing period at 60 feet, the patient noted that the right leg numbness was markedly decreased and his arm felt almost normal. His tandem gait had improved. After three O<sub>2</sub> breathing periods at 60 feet and following the 30-minute ascent to 30 feet, his tandem gait became completely normal and he was able to walk the length of the chamber heel to toe with his eyes closed. A sharpened Rhomberg was greater than 15 seconds. His speech and affect were normal as determined by the inside chamber tender. At this point complete resolution of symptoms had occurred. The patient surfaced from the TT VI at approximately 21:34. Immediately upon exiting the chamber, the patient was noted to be speaking and walking normally and went off to the bathroom to urinate and change clothes. During my interview 10 minutes after surfacing, the patient again appeared dazed. He did not respond to all the questions appropriately and he kept saying that he had “lost his bearings”. He said that his right arm and leg began to go numb about 10 minutes just before arriving at the surface during the final ascent from 30 feet. On physical examination his affect was flat and his speech is somewhat deliberate. He always paused before answering a question, but eventually got the right answer. The right arm is slightly weaker than left in flexors and extensors. Pinprick on the right arm and leg was decreased compared to the left. Pinprick on both sides of the abdomen and thorax was normal. He was unable to do a tandem gait or a sharpened Rhomberg and kept falling to the right. His finger-to-nose was very slow and deliberate but there was no past pointing. Approximately 40 minutes after surfacing, he felt faint and began to collapse to the floor but was caught before he did so and immediately taken into the chamber and put in one of the treatment chairs. In the chamber the examination continued as preparations for recompression were begun. No nystagmus was noted but he did complain of feeling nauseated and eventually vomited his stomach contents that consisted mainly of pizza that he had eaten during the first treatment. The patient then became totally unresponsive to verbal commands for a few seconds but



did not lose consciousness. He did respond to a loud voice but did not respond meaningfully to commands. He was not oriented at this time. Forty-5 minutes after surfacing from the first treatment, he was recompressed to 60 feet and began 100% O<sub>2</sub> breathing periods. After arrival at 60 feet the patient was still dazed and was not responding meaningfully to the tenders questions. The inside chamber tender would put his hands on parts of the patient's body and ask him to identify them, but the patient was unable to do so. He had a completely flat affect and responded only slowly and deliberate to commands. An IV of D5W was started and run at approximately one liter. Additional hyperbaric treatments, a test for PFO, and a complete neurological work-up followed. Was found to have a resting PFO.

## **Phase IV PRP: DCS Assigned at Hermann**

**96. Summary:** ID# H990511A, 29-year-old male, maximum Grade 0, first report at 92 minutes, study done on n = 57, independent sample statistical design.

### **Procedure 26**

**Narrative:** At 92 minutes, subject reported mild pain just below right knee. Reported initial pain score of 1–2 on a 1–10 scale. Subject also described a prickly hot and cold sensation on skin on top of right foot first and then on top of left foot. Subject was asked to move around and remove his shoes. This was felt to be due to postural effects and not related to DCS. Subject had no VGE. Last VGE record at 84 minutes with Grade 0 from right arm, Grade 0 from left arm, Grade 0 from left leg, and Grade 0 from right leg. Subject was locked out. Symptom in right knee resolved during descent to site pressure.

**Diagnosis:** Type I DCS

**Treatment:** Two-hr GLO with follow-up consultation.

**97. Summary:** ID# H990527B, 24-year-old male, maximum Grade 3, first VGE at 64 minutes, first report at 84 minutes, study done on n = 57, independent sample statistical design.

### **Procedure 26**

**Narrative:** At 84 minutes, subject reported only a mild aching pain on left knee. Sometime later, subject reported a sharp, constant pain on left knee under patella. Reported pain score of 7 on a 1–10 scale. Subject selected United States Air Force (USAF) Grade 2 pain as appropriate descriptive index. Subject said that pain started about 10 minutes earlier as a sensation of awareness. First VGE detected at 64 minutes, Grade 0 from right arm, Grade 0 from left arm, Grade 3 from left leg, and Grade 0 from right leg. Last VGE record at 80 minutes with Grade 0 from right arm, Grade 0 from left arm, Grade 3 from left leg, and Grade 0 from right leg. Subject was locked out. Symptoms in the left knee resolved during descent at 7.3 psia with no residual pain at site pressure.

**Diagnosis:** Type I DCS

**Treatment:** Two-hr GLO with follow-up consultation.

**98. Summary:** ID# H990610A, 25-year-old male, maximum Grade 2, first VGE at 45 minutes, first report at 45 minutes, study done on n = 57, independent sample statistical design.

## **Procedure 26**

**Narrative:** At 45 minutes, subject reported mild aching of right knee. Reported initial pain score of 2 on a 1–10 scale and then 3–4 a short time later. Subject first complained of hot spots at 12 minutes into the 4.3-psia exposure. VGE detected at 45 minutes, Grade 0 from right arm, Grade 0 from left arm, Grade 0 from left leg, and Grade 2 from right leg. Last VGE record was also at 45 minutes with Grade 0 from right arm, Grade 0 from left arm, Grade 0 from left leg, and Grade 2 from right leg. Decision was made to remove subject from test. Subject was locked out approximately 50 minutes into test. Symptoms in right knee resolved during descent at 12.7 psia with no residual pain at site pressure.

**Diagnosis:** Type I DCS

**Treatment:** Two-hr GLO with follow-up consultation.

**99. Summary:** ID# H990615B, 28-year-old male, maximum Grade 3, first VGE at 169 minutes, first report at 183 minutes, study done on n = 57, independent sample statistical design.

## **Procedure 26**

**Narrative:** At 183 minutes, subject reported mild intermittent aching in left knee. Pain was intermittent but could be noticed when leg was extended. Reported initial pain score of 3 on a 1–10 scale. Subject was asked to reposition himself to determine whether the sensation was due to positional/postural causes. Pain disappeared with repositioning, but then returned when left leg was stretched out. First VGE detected at 169 minutes, Grade 0 from right arm, Grade 0 from left arm, Grade 3 from left leg, and Grade 0 from right leg. Last VGE record at 247 minutes with Grade 0 from right arm, Grade 0 from left arm, Grade 3 from left leg, and Grade 0 from right leg. Decision was made to remove subject from test, but the scheduled end of test had arrived so no lockout was required. Symptoms in left knee resolved during descent with no residual pain at site pressure.

**Diagnosis:** Type I DCS.

**Treatment:** Two-hr GLO. Phoned next day with report of tenderness in left elbow. Given a USN HBO TT V treatment, with no relief. Was given anti-inflammatory medication. Diagnosis was epicondylitis (tennis elbow) due to repeated arm and handwork the previous day. Follow-up consultation the next day was done.

## **Phase IV PRP: DCS Assigned at DCIEM**

**100. Summary:** ID# C990311B, 28-year-old male, maximum Grade 3, first VGE at 31 minutes, first report at 31 minutes, study done on n = 57, independent sample statistical design.

## **Procedure 26**

**Narrative:** At 31 minutes, subject reported discomfort in left knee aggravated by exercise. First VGE detected at 31 minutes, Grade 0 from right arm, Grade 0 from left arm, Grade 3 from left leg, and Grade 0 from right leg. Last VGE record was also at 31 minutes with Grade 0 from

right arm, Grade 0 from left arm, Grade 3 from left leg, and Grade 0 from right leg. Subject was locked out at 48 minutes. Symptoms in left knee cleared at 10.92 psia.

**Diagnosis:** Type I DCS

**Treatment:** Two-hr GLO with follow-up consultation.

**101. Summary:** ID# C990315D, 45-year-old male, maximum Grade 4, first VGE at 40 minutes, first report at 56 minutes, study done on n = 57, independent sample statistical design.

### **Procedure 26**

**Narrative:** At 56 minutes, subject reported discomfort in left knee, fading in and out. Reported initial pain score of 2 on a 1–10 scale. At 68 minutes, the report was still intermittent level 2 pain score in left knee. At 72 minutes, subject reported a slight improvement, and it was decided to remove subject from test. First VGE detected at 40 minutes, Grade 0 from right arm, Grade 0 from left arm, Grade 3 from left leg, and Grade 0 from right leg. Last VGE record at 56 minutes with Grade 0 from right arm, Grade 1 from left arm, Grade 4 from left leg, and Grade 1 from right leg. Subject was locked out at 74 minutes. Symptoms in left knee cleared shortly after start of descent.

**Diagnosis:** Type I DCS

**Treatment:** Two-hr GLO with follow-up consultation.

**102. Summary:** ID# C990317D, 41-year-old male, maximum Grade 4, first VGE at 93 minutes, first report at 118 minutes, study done on n = 57, independent sample statistical design.

### **Procedure 26**

**Narrative:** At 118 minutes, subject reported a sore left leg. At 121 minutes, reported steady discomfort. At this time, subject reported initial pain score of 2–3 on a 1–10 scale. At 124 minutes, reported left knee pain was 4–5 on the pain score. First VGE detected at 93 minutes, Grade 0 from right arm, Grade 0 from left arm, Grade 3 from left leg, and Grade 0 from right leg. Last VGE record at 109 minutes with Grade 0 from right arm, Grade 2 from left arm, Grade 4 from left leg, and Grade 2 from right leg. Subject was locked out at 129 minutes. Symptoms in left knee cleared at 9.35 psia.

**Diagnosis:** Type I DCS

**Treatment:** Two-hr GLO with follow-up consultation.

**103. Summary:** ID# C990324C, 35-year-old male, maximum Grade 4, first VGE at 40 minutes, first report at 92 minutes, study done on n = 57, independent sample statistical design.

### **Procedure 26**

**Narrative:** At 92 minutes, subject reported awareness in right ankle and right knee. At 108 minutes, he reported constant awareness in right ankle and right knee, not a pain. At 116

minutes, he reported increased awareness in right knee at a 1–2 pain score on a 10-point pain scale with right ankle awareness less noticeable. First VGE detected at 40 minutes, Grade 0 from right arm, Grade 0 from left arm, Grade 0 from left leg, and Grade 2 from right leg. Last VGE record at 108 minutes with Grade 2 from right arm, Grade 3 from left arm, Grade 3 from left leg, and Grade 4 from right leg. Subject was locked out at 116 minutes. Symptoms were mostly gone at 6.75 psia with significant ear clearing problems below 7.34 psia. Subject had no symptoms in right ankle or right knee at 9.35 psia.

**Diagnosis:** Type I DCS

**Treatment:** Two-hr GLO with follow-up consultation.

### **Phase V-1 PRP: DCS Assigned at Duke**

**104. Summary:** ID# D021219C, 27-year-old male, maximum Grade 4, first VGE at 96 minutes, first report at 110 minutes a symptom he noticed at 90 minutes, study done on n = 9, independent sample statistical design.

#### **Procedure 27**

**Narrative:** At 110 minutes the subject reported a symptom that he first experienced at about 90 minutes. The subject noticed a very mild, but steady, right knee pain. This pain was slightly off the midline, on the medial side of the right knee, at the joint line. It is somewhat sharp, but deep. The pain did not subside, but grew slowly, but steadily worse. Subject has no history of knee pain, or previous knee injury. At 110 minutes into the 30,250 foot exposure, subject reported the pain to the tender. The pain was reported initially at a 2/10, and increased to a 3/10 just before descent. At 115 minutes the subject was removed from the chamber. The subject was noted to have a 4/4 Doppler score while moving his right lower extremity, and a large amount of bubbles were observed in the right heart on 2D echocardiography when he moved his lower extremity. First VGE were detected at 96 minutes, Grade 3 from the right leg, then at 122 minutes Grade 4 from the right leg. All other limb measurements had Grade 0 VGE. The subject was returned to surface. During the surface the pain rapidly improved, and was a 0.5/10 at the surface. After breathing oxygen on the surface for 5 minutes the pain was barely noticeable.

**Diagnosis:** Type I DCS

**Treatment:** Two-hr GLO with follow-up consultation.

**105. Summary:** ID# D030122B, 30-year-old male, maximum Grade 4, first VGE at 43 minutes, first report at 80 minutes, study done on n = 9, independent sample statistical design.

#### **Procedure 27**

**Narrative:** At 80 minutes after reaching altitude and after the third exercise period the subject noticed and reported the onset of a sharp left ankle pain. This pain was constant but the severity waxed and waned between 2 to 4 out of 10. It was worse with movement. By 85 minutes the pain began to radiate to the left knee and thigh. Subject did not develop other symptoms. However, because this pain was constant in nature >5 minutes (did not completely resolve) he was

removed from the exposure as per the NASA protocol. First VGE were detected at 43 minutes, Grade 3 from the left leg and again at 67 minutes, then at 78 minutes Grade 4 from the left leg. All other limb measurements had Grade 0 VGE. Upon recompression to sea level the subject reported a gradual disappearance of his pain and was pain free within 5 minutes of arriving at sea level.

**Diagnosis:** Type I DCS

**Treatment:** Two-hr GLO with follow-up consultation.

**106. Summary:** ID# D030122C, 48-year-old male, maximum Grade 2, first VGE at 33 minutes, first report at 62 minutes, study done on n = 9, independent sample statistical design.

### **Procedure 27**

**Narrative:** At 62 minutes after reaching altitude and after the third exercise period the subject noticed and reported the onset of a sharp right shoulder pain. *Note: The case description in the PRP database indicates left shoulder pain initially, but goes on to describe right shoulder pain, which we accept as the correct location of the symptom.* This waxed and waned between 2 to 4 out of 10 in severity. It was not worse with movement. The shoulder pain was also accompanied by some transient right wrist and forearm pain. Subject did not develop other symptoms. However, because this pain was constant in nature >5 min (did not resolve completely) he was removed from the exposure as per the NASA protocol. First VGE were detected at 33 minutes, Grade 1 from the right arm. At 50 minutes there was Grade 2 in right arm, then at 70 minutes there were Grade 2 in right arm, Grade 1 in left arm, and Grade 2 in left leg. Finally, at 86 minutes there was Grade 2 in right arm, Grade 1 in left arm, and Grade 2 in left leg. Upon recompression to 18,000 feet altitude (7.34 psia) the subject reported a gradual disappearance of his pain and was pain free at sea level. *Note: While primary symptoms (as described in consult note) were reported in the right shoulder, the subject also described to investigators a dull and localized knee pain (2-3/10) that commenced suddenly at 85 minutes at altitude that also disappeared during repress. But this additional information did not specify right or left knee.*

**Diagnosis:** Type I DCS

**Treatment:** Two-hr GLO with follow-up consultation.

### **Phase V-2 PRP: DCS Assigned at Duke**

**107. Summary:** ID# D030327A, 43-year-old female, maximum Grade 4, first VGE at 7 minutes, first report at 128 minutes, study done on n = 3, independent sample statistical design.

### **Procedure 28**

**Narrative:** At 128 minutes subject developed the gradual onset of nausea without vomiting. Later questioning (after recompression to surface pressure) revealed that she also had developed some mild shortness of breath, throat fullness and cough around this time, but this was not communicated. The covering physician was called to evaluate her and remarked that at 129 minutes she reported nausea, malaise and weakness which progressed to lightheadedness by 130

minutes. The covering physician was not concerned that the reported degree of nausea was a severe enough symptom to remove her from the study at that time. However, at approximately 131 minutes it became known to the covering physician that she had had Grade 4 venous gas emboli during the course of the study. At that time the covering physician requested a repeat left ventricular sided echo which was transmitted to the outside monitor. No left ventricular sided bubbles were observed, however; due to the rapid progression of the symptoms of increasing nausea combined with light headedness and the apparent anxiety and distress of the subject the covering physician elected to evacuate her from the altitude chamber. First VGE were detected at 7 minutes, Grade 1 from right and left arms, with VGE grade increasing from all limbs over the next five sample intervals. Final VGE collection at 128 minutes showed Grade 3 in right arm, Grade 4 in left arm, Grade 3 in left leg, and Grade 4 in right leg. At 138 minutes the Delta chamber was depressurized with an attendant to lock out the subject. However, by the time the lock was able to be opened (145 min) the subject was in too much distress to be able to stand without assistance. At that point the covering physician began to suspect that the reported symptoms might represent the precursors to pulmonary decompression sickness and it was elected to abort the entire flight (146 min) to allow her to be extracted as soon as possible. By 154 minutes the subject had been recompressed to surface pressure and while remaining on 100% O<sub>2</sub> she was removed from the chamber on a stretcher. She was taken to an adjacent room for an abbreviated history and physical exam by the covering physician. Upon reaching the surface she reported mild but improving respiratory distress. On exam at that time she was diaphoretic, and flushed, however she did not have tachypnea and O<sub>2</sub> saturation was 100%. Her heart rate was 60. Blood pressure was not immediately taken but she appeared well perfused. She was oriented x 3, CN (cranial nerves?) were grossly normal. She had very soft rales at the bases but these were noted to clear within minutes (see second pulmonary exam in Alpha chamber below). There was no S3 or S4 on cardiac exam. Her neurological exam was normal with symmetrical motor strength, normal cognition and normal cranial nerves.

**Diagnosis:** Type II DCS, pulmonary chokes

**Treatment:** USN HBO TT VI with follow-up consultation. A diagnosis of altitude DCS with pulmonary involvement was made and it was elected to treat her with hyperbaric O<sub>2</sub>. The subject was walked, with escorts on either side, to Alpha chamber so that the examining physician could continue to observe both her strength as well as her neurological status as reflected by her gait and balance. Her gait was "cautious" but otherwise normal and although she was able to stand on one foot she was weak. By the time she reached Alpha chamber she was able to stand without assistance, however; she still complained of feeling weak and tired. In Alpha, her lungs were also reexamined to note any interim improvement. No rales were heard on the second chest exam, however; the background noise level was high. Although the issue was briefly discussed during the examination period, no chest x-ray or blood study was obtained in the interest of beginning treatment as rapidly as possible and because the patient seemed to be improving at ground-level pressure. The examination and transport of the patient to Alpha chamber was totally completed at 173 minutes. The final preparations were made and the chamber was pressurized at 174 minutes.

By 176 minutes, she had been compressed to 60 feet sea water pressure and she reported improvement of her shortness of breath. At 195 minutes all symptoms were reported to be gone and she was joking with the chamber attendant in light hearted conversation. A brief

neurological exam in the chamber revealed a normal gait, normal Romberg and normal heel to toe walking as observed by me over the video monitor. The decision was made to complete a full USN TT VI in hopes of avoiding a recurrence of symptoms.

Addendum: 3/28/03 10:00 a.m.

After the treatment there were no recurrent symptoms and she felt subjectively much better. Vital signs were normal (blood pressure 114/78, heart rate 70) and her lungs were clear. Subject was sent to the Duke emergency room for a chest x-ray. The covering physician was called with the report at 21:50. No abnormalities were seen by the reading radiologist and the patient was discharged home. The following morning (3/29/03, 9:59 am) the subject was called by the covering physician and reported that she had had no recurrence of her symptoms and she was in her normal state of health. She was advised to call for any symptoms or questions that might arise.

### **Phase V-3 PRP: DCS Assigned at DCIEM**

**108. Summary:** ID# C030612A, 27-year-old female, maximum Grade 3, first VGE at 144 minutes, first report at 128 minutes, study done on n = 48, independent sample statistical design.

#### **Procedure 29**

**Narrative:** At 128 minutes, subject stated that she felt some fullness in her left ankle. Doppler scores at the time were all zero. This was not described as pain at the time, so it was decided to monitor her. Subject had no previous history of left ankle problems. By 138 minutes, subject stated that the fullness was a discomfort that was 1-2/10 on rest and with movement. It had progressed from an undulating feeling to a discomfort that was constant. First VGE detected at 144 minutes with Grade 2 in right leg and Grade 3 in left leg. TTE also indicated bubbles on the right side of the heart. By 153 minutes, the left ankle pain was 1-2/10 on rest and 3/10 with movement. VGE grade at the next and last monitoring opportunity at 160 minutes was Grade 3 in left and right legs. The reported symptoms met NASA criteria for protocol termination due to Type I DCS; the flight was terminated, subject was placed in the air lock and brought back down to ground-level. During descent her left ankle pain completely resolved by the time the lock reached 27,000 ft (4.99 psia). She remained asymptomatic at ground-level with VGE grades returning to 0.

**Diagnosis:** Type I DCS

**Treatment:** Two-hr GLO with follow-up consultation.

**109. Summary:** ID# C030626B, 46-year-old female, maximum Grade 3, first VGE at 96 minutes, first report at 144 minutes, study done on n = 48, independent sample statistical design.

#### **Procedure 29**

**Narrative:** At 144 minutes, subject reported the development of a 'feeling of fullness' in her right ankle. Moments later the subject reported that the feeling of fullness in the right ankle was still present, and that she occasionally got a very mild, deep, 'shooting' pain in her leg, like a

'shower of bubbles' (she had no knowledge of her bubble scores). Dr. Nishi elected to observe this probable DCS symptom for a few more minutes. At 158 minutes the subject reported that the fullness and occasional pain was still present but less. The pain in her ankle was now constant at 3/10 so the decision was made to lock her out. The 'fullness' and pain were definitely better by 20,000 ft (6.75 psia) during the descent and completely resolved by 5,000 ft (12.23 psia). First VGE detected at 96 minutes, Grade 3 from right leg. At 112 minutes there was still Grade 3 VGE from the right leg. At 132 minutes there was Grade 3 from right and left arms and right leg with Grade 2 from left leg. At 148 minutes there was Grade 3 from the right leg. The last VGE monitoring was at 164 minutes with Grade 1 from right and left arms and grade 2 from right and left legs. Subject continued on 100% O<sub>2</sub> on the surface for two h and encouraged to drink large amounts of fluids. She was examined and found to have absolutely no residual signs or symptoms of the DCS and volunteered that she was in her menstrual period. Incidental note is made of a very mild headache that started the previous day and had continued unchanged during the run.

**Diagnosis:** Type I DCS

**Treatment:** Two-hr GLO with follow-up consultation.

**110. Summary:** ID# C030916A, 59-year-old male, maximum Grade 3, first VGE at 40 minutes, first report at 170 minutes, study done on n = 48, independent sample statistical design.

#### **Procedure 29**

**Narrative:** At 170 minutes, subject reported 2-3/10 left knee discomfort. The discomfort was constant at rest and with movement, and had been gradually getting worse for 7-8 minutes. He had no previous history of left knee problems, was well hydrated and had no known risk factors for altitude DCS. This met NASA criteria for protocol termination due to Type I pain only altitude DCS, and it was decided to terminate the flight. By the time the airlock had reached altitude and he was transferred into it at 183 minutes, his left knee pain had increased to 5/10. First VGE detected at 40 minutes, grade 1 from left and right legs. VGE grades increased from lower body over several sampling intervals. Last VGE sample was at 176 minutes with Grade 3 VGE from all four limb locations. During descent, his knee pain gradually improved. By 27,000 ft (4.99 psia) it had decreased to 2/10, by 21,000 ft (6.48 psia) it was 1/10, and as the chamber broke through 18,000 ft (7.34 psia), he reported complete resolution of the knee pain. He remained asymptomatic at ground-level and did not require hyperbaric recompression.

**Diagnosis:** Type I DCS

**Treatment:** Two-hr GLO with follow-up consultation.

**111. Summary:** ID# C030930C, 35-year-old female, maximum Grade 3, first VGE at 68 minutes, first report at 104 minutes, study done on n = 48, independent sample statistical design.

#### **Procedure 29**

**Narrative:** At 104 minutes, subject reported a mild sensation in the muscle of her left thigh. She did not describe it as a pain or discomfort, and it was not felt to be related to altitude DCS. By



116 minutes, subject noted that the sensation in her thigh had now migrated to her left knee. At 123 minutes, the sensation in her knee had definitely become a pain (*Note: PRP database documents 116 minutes as the time to DCS*). It was constant, and slightly worse with movement. At 129 minutes, she stated the pain was 5/10 and worsening. This met the NASA criteria for protocol termination due to Type I pain only altitude DCS, and it was decided to terminate the flight. First VGE detected at 68 minutes, Grade 2 in left leg and Grade 1 in right leg. At 82 minutes there was Grade 2 from right and left arms and Grade 3 from left and right legs. Last VGE monitoring at 114 minutes indicated Grade 3 from all four limbs. By the time the airlock reached altitude, and she was transferred into it at 133 minutes, the left knee pain had increased to 6/10. During descent, her knee pain gradually improved. By 27,000 ft (4.99 psia) it had decreased to 4/10, by 22,000 ft (6.21 psia) it was 3/10, and as the chamber broke through 16,000 ft (7.96 psia), she reported complete resolution of the knee pain. She remained asymptomatic at ground-level and did not require recompression therapy.

**Diagnosis:** Type I DCS

**Treatment:** Two-hr GLO with follow-up consultation.

### **Phase V-3 PRP: DCS Assigned at Duke**

**112. Summary:** ID# D030825B, 47-year-old male, maximum Grade 3, first VGE at 59 minutes, first report at 195 minutes, study done on n = 48, independent sample statistical design.

#### **Procedure 29**

**Narrative:** At 195 minutes, subject experienced onset of left ankle and left knee pain. Symptoms were somewhat variable and improved with exertion. Severity eventually reached 3/10 over the next few minutes. VGE first detected at 59 minutes, Grade 3 from right arm. Low grade VGE (Grades 1 and 2) persisted from right arm up until 126 minutes. At 179 minutes Grade 2 VGE were detected in left and right legs and at the last VGE monitoring opportunity at 199 minutes there were also Grade 2 VGE from both legs. The condition following completion of the last Doppler showed no further change in symptomatology with continued 3/10 deep dull ache in the left knee ankle and shin. The subject was electively brought out of the chamber at 204 minutes, reaching the surface at 211 minutes. Severity of the constant leg/ankle ache during compression decreased to less than 1/10 over the left ankle. He remained on GLO while undergoing physical examination.

**Diagnosis:** Type I DCS

**Treatment:** Some GLO in preparation for USN HBO TT V with follow-up consultation. The patient was compressed on a USN TT V at 16:04 (229 min elapsed). He experienced 100% relief of all symptoms at 16:07 (232 min elapsed) upon reaching 60 feet sea water. He completed the remainder of the treatment without problem or difficulty.

**113. Summary:** ID# D031009B, 25-year-old male, maximum Grade 3, first VGE at 43 minutes, first report at 61 minutes, study done on n = 48, independent sample statistical design.

## Procedure 29

**Narrative:** At 61 minutes, subject complained of a 4/10 deep steady dull pain in his right shoulder that was present at rest and did not change with arm motion (*Note: PRP database case description documents 76 minutes to report of symptom while elapsed time data in the same database confirms 61 minutes to report of first symptom. Will use 61 minutes since a report of symptoms at 76 minutes is longer than the last VGE monitoring period at 65 minutes*). First VGE detected at 43 minutes, Grade 2 from right arm. Next, and last, VGE monitoring at 65 minutes had Grade 3 from right arm. The shoulder pain decreased in severity to a 3/10 immediately prior to recompression to surface and resolved during the descent.

**Diagnosis:** Type I DCS

**Treatment:** Some GLO in preparation for USN HBO TT V with follow-up consultation. The subject tolerated compression for treatment of Type I DCS with USN TT V. All symptoms (right shoulder pain) resolved during descent from altitude and did not recur at 1 ATA or during hyperbaric recompression and treatment. On exam following treatment, the subject was without complaint and at his baseline level on physical examination without signs or symptom of DCS.

**114. Summary:** ID# D031106B, 45-year-old female, maximum Grade 0, first report at 106 minutes, study done on n = 48, independent sample statistical design.

## Procedure 29

**Narrative:** At 106 minutes, subject complained of “itchy dry skin” and a “prickly” sensation on both arms and legs of a 4/10 severity (*Note: PRP database documents 162 minutes as the time to DCS*). She had no neurological deficit or complaint of pain. At 162 minutes she complained of 6/10 tingling in her left forearm during arm exercise which resolved during rest. At 172 minutes she complained of 7/10 tingling and pain which decreased but did not resolve during rest. VGE monitoring at approximately 15 minute intervals showed no detectable bubbles. The subject was repressurized after a 172 minute exposure. Symptom decreased in severity from 7/10 to 1.5/10 upon reaching the surface. She was examined and taken to Alpha Chamber for treatment of mild Type-1 DCS.

**Diagnosis:** Type I DCS

**Treatment:** Some GLO in preparation for USN HBO TT V with follow-up consultation. Subject noted decreased sensation/pain on compression to 60 feet sea water with complete resolution within 2 minutes of breathing O<sub>2</sub> at 60 feet sea water. She completed the USN TT V without problem or complication.

## Phase V-4 PRP: DCS Assigned at Duke

**115. Summary:** ID# D040817B, 29-year-old male, maximum Grade 2, first VGE at 64 minutes, first report at 141 minutes, study done on n = 6, independent sample statistical design.

### Procedure 30

**Narrative:** At 141 minutes, subject complained of a 5/10 deep steady dull pain in his right knee and 3/10 ankle pain that was present at rest and did not change with motion. The reported severity of the knee pain was increased to 6/10 and ankle pain to 5/10 at 143 minutes. The flight was aborted at this time. First VGE detected at 64 minutes, a Grade 2 from the right leg. No VGE detected in the next three opportunities. But at 130 minutes Grade 2 was once again coming from the right leg. Both knee and ankle pain decreased in severity upon recompression to surface, the knee reaching 0/10 and the ankle 1/10. The knee pain returned to a 2/10 level two minutes into the immediate post-flight period. There were no complaints of motor weakness, shortness of breath or cognitive disturbances reported.

**Diagnosis:** Type I DCS

**Treatment:** Some GLO in preparation for USN HBO TT V with follow-up consultation. Examination at the surface was at baseline and without neurological deficit. Symptoms were completely resolved upon reaching the USN TT V treatment depth. The subject remained symptom free immediately following treatment and at 18 hr follows up.

**116. Summary:** ID# D040831A, 28-year-old female, maximum Grade 4, first VGE at 160 minutes, first report at 199 minutes a symptom she noticed at 198 minutes, study done on n = 6, independent sample statistical design.

### Procedure 30

**Narrative:** At 199 minutes, subject experienced onset of 2/10 left ankle pain. She reported that she had been experiencing a sharp, constant pain in her left foot for the previous minute. The pain slowly progressed to her ankle then lower extremity over the next couple of minutes. The intensity and character did not change at rest or with exercise. The patient symptom report form was reviewed at 205 minutes and the decision was made to bring the subject back to ambient pressure. First VGE detected at 160 minutes, Grade 2 from left leg and grade 3 from right leg. At 176 minutes there was Grade 2 from both arms, Grade 3 from left leg and grade 4 from right leg. Final, and last, VGE monitoring was at 196 minutes with Grade 2 from right arm, Grade 1 from left arm, Grade 2 from left leg, and Grade 4 from right leg. The subject remained on O<sub>2</sub> and was repressurized to ambient pressure after 210 minutes at altitude. Symptoms resolved completely at 10,000 ft (10.11 psia) during descent.

**Diagnosis:** Type I DCS

**Treatment:** Some GLO in preparation for USN HBO TT V with follow-up consultation. Subject was without complaint and taken to Alpha chamber for prophylactic treatment with USN TT V following resolution of Type I DCS with descent from altitude. Subject tolerated compression without problem or complaint. She remained asymptomatic throughout the remainder of the treatment.

**117. Summary:** ID# D040915A, 49-year-old female, maximum Grade 2, first VGE at 129 minutes, first report at 31 minutes, study done on n = 6, independent sample statistical design.

### **Procedure 30**

**Narrative:** At 31 minutes, subject had minimal brief left great toe pain (grade 2/10), which decreased after 40 minutes and became intermittent and was totally resolved 76 minutes into the exposure (*Note: PRP database documents 127 minutes as the time to DCS*). Subject reported at 127 minutes a slight (1/10), intermittent pain on the top inside of her left foot. The pain progressed to the outside of the top of her left foot, increased to grade 3 intensity, and became constant at 139 minutes. The intensity and character did not change at rest or with exercise. The intensity increased to grade 4 after 142 minutes and the decision was made to bring the subject back to ambient pressure. First and only VGE detected at 129 minutes, Grade 2 from the left leg. The subject remained on O<sub>2</sub> and was repressurized to ambient pressure after 144 minutes at altitude. Symptoms decreased in intensity at 15,000 ft (8.29 psia) and resolved completely at 5,500 ft (12.0 psia) during descent.

**Diagnosis:** Type I DCS

**Treatment:** Some GLO in preparation for USN HBO TT V with follow-up consultation. Subject was without complaint and taken to Alpha chamber for prophylactic treatment with USN TT V following resolution of Type I DCS with descent from altitude. Subject tolerated compression without problem or complaint. She remained asymptomatic throughout the remainder of the treatment.

### **Phase V-5 PRP: DCS Assigned at Duke**

**118. Summary:** ID# D070515A, 21-year-old female, maximum Grade 4, first VGE at 24 minutes, first report at 58 minutes, study done on n = 48, independent sample statistical design.

### **Procedure 31**

**Narrative:** At 58 minutes, subject experienced sudden onset of 5/10 right knee pain. Pain was sharp, constant and circumferentially involved the entire right knee. It was of a character similar to her usual knee pain following a very long and strenuous run. It did not change in intensity or quality with position, palpation or pressure. First VGE detected at 24 minutes, Grade 3 from right leg. At 40 minutes there was Grade 1 from left leg and Grade 3 from right leg. Final monitoring period at 56 minutes revealed Grade 2 from left leg and Grade 4 from right leg. Initiated recompression to surface pressure within 5 minutes of symptom onset. The intensity of pain decreased to 2/10 at 26,000 ft (5.22 psia), 1/10 at 20,000 ft (6.75 psia) and fully resolved at 17,000 ft (7.65 psia) (three minutes after beginning recompression). The subject was examined after return to ambient pressure and then immediately taken into Bravo chamber for treatment with a USN TT V.

**Diagnosis:** Type I DCS

**Treatment:** Some GLO prior to USN HBO TT V with follow-up consultation. Prophylactically treated with USN TT V in order to avoid potential recurrence of pain. Compression began 26 minutes following onset of pain. Administered 600 mg ibuprofen upon completion of treatment. Compression and decompression were without incident. Physical findings remained unchanged and normal throughout.

**119. Summary:** ID# D070821A, 39-year-old male, maximum Grade 4, first VGE at 76 minutes, first report at 93 minutes a symptom he noticed at 73 minutes, study done on n = 48, independent sample statistical design.

### **Procedure 31**

**Narrative:** At 93 minutes, subject complained of a 3-6/10 constant, shooting pain in his right knee that quickly extended into his right thigh. The decision by the subject to notify inside tenders was made after flexing the knee when the sharp pain became clearly apparent. The Medical Officer was notified at 94 minutes. On questioning, it was noted that the pain did not change in character or intensity with motion. First VGE detected at 76 minutes, Grade 1 from left leg and Grade 2 from right leg. Final monitoring period at 92 minutes revealed Grade 3 from left leg and Grade 4 from right leg. The decision was made to bring the subject back to surface pressure at 95 minutes. The subject left 30,250 ft (4.3 psia) at 104 minutes with full resolution of symptoms by 106 minutes while passing 8000 ft (10.92 psia). He reached the surface at 108 minutes, was transferred on O<sub>2</sub> to Bravo chamber. The subject had no complaints and the physical exam at this time was normal and non-focal for any deficits. On questioning the subject mentioned that he experienced a mild non-specific right knee “ache” for 20 minutes prior to reporting the frank right knee pain.

**Diagnosis:** Type I DCS

**Treatment:** Some GLO prior to prophylactic USN HBO TT V with follow-up consultation. Exam following USN TT V was non-focal and unchanged from pre-flight physical.

## **Selected Narratives Where DCS Was Not Diagnosed**

### **Bends 1c: Narratives but no DCS Assigned at JSC**

**1. Summary:** ID# 16-01, 21-year-old male, maximum Grade 1, first VGE at 26 minutes, first report after the end of the test during debrief, estimated at 120 minutes into the test, study done on n = 11, independent sample statistical design.

#### **Procedure 3**

**Narrative:** During debrief, subject mentioned that he felt some transient pain in middle of left foot, and tightening in left knee similar to what he experiences when running. He recalled that this appeared at the beginning of the second hr at 4.3 psia. Did not report initial pain score on the 1–10 scale. First VGE detected at 26 minutes, Grade 0 from left arm, Grade 1 from left leg, Grade 0 from right arm, and Grade 0 from right leg. Last VGE record at 169 minutes with Grade 0 from left arm, Grade 0 from left leg, Grade 0 from right arm, and Grade 0 from right leg. Subject did not report if there was a change in any symptoms during descent. During debrief, subject described symptoms he had during the test to the PI. Since symptoms in the left foot and left knee were still present at site pressure, a hyperbaric treatment was given. Symptoms did not respond to hyperbaric treatment.

**Diagnosis:** No DCS

**Treatment:** HBO provided to evaluate symptoms still present in left foot and left knee, but treatment table was not noted in the logbook. Treatment did not resolve the symptoms, so these were attributed to the exercise protocol used during the test. Follow-up consultation the next day was done.

### **Bends 2a: Narratives but no DCS Assigned at JSC**

**2. Summary:** ID# 29-02, 43-year-old male, maximum Grade 0, first report at 72 minutes, study done on n = 23, independent sample statistical design.

#### **Procedure 5**

**Narrative:** At 72 minutes, during 1<sup>st</sup>-hr questioning, subject reported a little pain in left wrist that lasted about 30 seconds. Did not report initial pain score on the 1–10 scale. Subject had no VGE during the test. Last VGE record at 236 minutes with Grade 0 from left arm, Grade 0 from left leg, Grade 0 from right arm, and Grade 0 from right leg. It was out of normal protocol not to have a period of questioning for 2<sup>nd</sup>-, 3<sup>rd</sup>-, or 4<sup>th</sup>-hr questioning of this subject during test. Also During the test, 2 other chamber mates (37-02 and 21-02) were reporting symptoms that disrupted the normal flow of the experiment. There were no symptoms prior to descent; symptoms resolved at the test altitude of 4.3 psia. During debrief, subject described momentary symptom in left wrist as a pain or strain, which occurred during the ergometer cranking. It felt like a muscle strain, and did not occur for the duration of the test.

**Diagnosis:** No DCS

**Treatment:** None, just self-monitoring most likely with follow-up consultation.

### **Bends 3a: Narratives but no DCS Assigned at JSC**

**3. Summary:** ID# 48-02, 36-year-old male, maximum Grade 0, first report at 342 minutes a symptom he noticed at about 322 minutes, study done on n = 28, independent sample statistical design.

#### **Procedure 7**

**Narrative:** At 342 minutes, subject reported intermittent pain under right shoulder. Did not report initial pain score on the 1–10 scale. He mentioned that symptom was first noticed about 20 minutes earlier (322 minutes). At 6<sup>th</sup>-hr questioning, he reported that for last 2 or 3 minutes the pain had become continuous and moved toward center of back. He had no VGE during the test. Last VGE record at 349 minutes with Grade 0 from left arm, Grade 0 from left leg, Grade 0 from right arm, and Grade 0 from right leg. Symptoms in back “pretty much gone” at 7.3 psia. During debrief at site pressure subject rated the intensity of pain in back a 1–2 pain score. It was questionable if symptoms in back cleared in a dramatic fashion, similar to what the PI had previously experienced.

**Diagnosis:** None, Grade 1 Type I DCS was initially diagnosed; but after re-review 1 week later, the PI classified this as exercise-induced symptoms since a history of these symptoms was documented in records of the pre-test exercise training and the indefinite verification of symptoms during recompression to site pressure.

**Treatment:** None, medical observation provided most likely for 12 h with follow-up consultation.

### **Bends 3b: Narratives but no DCS Assigned at JSC**

**4. Summary:** ID# 10-05, 45-year-old male, maximum Grade 2, first VGE at 161 minutes, first report at 180 minutes, study done on n = 35, independent sample statistical design.

#### **Procedure 8**

**Narrative:** At 180 minutes, during 3<sup>rd</sup>-hr questioning, subject reported constant discomfort in right shoulder. Reported initial pain score of 1–2 on a 1–10 scale. At the 4<sup>th</sup>-hr questioning, he said symptoms were the same, still a 1–2 pain score. First VGE detected at 161 minutes, Grade 0 from left arm, Grade 0 from left leg, Grade 2 from right arm, and Grade 0 from right leg. Next VGE monitoring was at 197 minutes, Grade 1 from left arm, Grade 2 from left leg, Grade 2 from right arm, and Grade 0 from right leg. Last VGE record at 360-minutes with Grade 0 from left arm, Grade 0 from left leg, Grade 0 from right arm, and Grade 0 from right leg. At 5<sup>th</sup>-hr questioning, he said discomfort was in right shoulder joint and muscle, on a 1–2 pain score, and was similar to how his shoulder felt after an injury he had about 1 year earlier. At 6<sup>th</sup>-hr questioning, subject reported symptoms in right shoulder were still on a 1–2 pain score. Symptoms in right shoulder did not resolve during repressurization to site pressure. During debrief, subject

mentioned he had constant discomfort from third hr on in right shoulder and right elbow. It still felt the same, on a 1–2 pain score. He was asked to crank the hand ergometer at 10.2 psia, the storage pressure prior to a second test the next day, and reported the same muscle soreness that he had previously reported.

**Diagnosis:** No DCS

**Treatment:** None, just self-monitoring most likely with follow-up consultation.

### **Bends 3d: Narratives but no DCS Assigned at JSC**

**5. Summary:** ID# 43-05, 25-year-old male, maximum Grade 3, first VGE at 130 minutes, first report at 179 minutes, study done on n = 12, independent sample statistical design.

#### **Procedure 10**

**Narrative:** Subject had reported symptoms at first hr in left shoulder the day before while at 4.3 psia. The PI was not convinced these were symptoms of DCS. Subject was clear to perform second test. At 3<sup>rd</sup>-hr questioning, subject reported slight discomfort in left shoulder. Reported initial pain score of 2–3 on a 1–10 scale. Awareness radiated from left shoulder to left elbow; subject had awareness while was lying down. At 4<sup>th</sup>-hr questioning, subject reported less pain in left shoulder compared to the previous report, with a pain score of 1. At 293 minutes, subject reported pressure on chest, a small pain in chest when he inhaled. Did not feel any symptoms when lying down, but felt symptom when he took a deep breath. At 5<sup>th</sup>-hr questioning, subject reported no symptoms from left shoulder. Pain in chest was at a pain score of 6 at its worst, but there was no coughing or need to cough. At 323 minutes, subject was asked about chest symptoms, and said no pain had reoccurred. At 6<sup>th</sup>-hr questioning, subject reported no symptoms in left shoulder. Symptoms in chest were just present for 5 minutes. First VGE detected at 130 minutes, Grade 0 from left arm, Grade 1 from left leg, Grade 0 from right arm, and Grade 0 from right leg. Last VGE record at 356 minutes with Grade 0 from left arm, Grade 0 from left leg, Grade 0 from right arm, and Grade 0 from right leg. There were no symptoms prior to descent; symptoms resolved at the test altitude of 4.3 psia. During debrief at site pressure, subject mentioned that pain in left shoulder was worse today, and more constant, than he had experienced the day before on his first exposure to 4.3 psia. Chest pain was not diagnosed by the MO as chokes during the test.

**Diagnosis:** No DCS

**Treatment:** None, just self-monitoring most likely with follow-up consultation.

### **Bends 5a: Narratives but no DCS Assigned at JSC**

**6. Summary:** ID# 94-01, 24-year-old female, maximum Grade 0, first report at 73 minutes, study done on n = 38, independent sample statistical design.

#### **Procedure 12**

**Narrative:** At 73 minutes, subject reported problem in right patella. Did not report initial pain



score on the 1–10 scale. At 84 minutes, reported discomfort in right wrist. At 93 minutes, subject reported that problem in right knee was worse, and he felt it when at the Doppler station but not at the exercise stations. At 110 minutes, subject reported discomfort in right wrist was present throughout previous exercise. At 2<sup>nd</sup>-hr questioning, a constant dull ache present at all times in the right wrist, but feeling in the right knee was only present at the Doppler monitoring station. At 3<sup>rd</sup>-hr questioning, subject reported symptom in right wrist had not bothered her over the last hr, and that she felt the right knee symptom when she bent down. At 4<sup>th</sup>- and 5<sup>th</sup>-hr questioning, subject reported being just fine, with no symptoms in right knee or right wrist. No VGE were detected during test. Last VGE record at 324 minutes with Grade 0 from left arm, Grade 0 from left leg, Grade 0 from right arm, and Grade 0 from right leg. There were no symptoms prior to descent; symptoms resolved at the test altitude of 4.3 psia. During debrief, subject mentioned she still felt something in right knee while squatting down, and recalled that she might have hurt right knee earlier in the week while playing with her children.

**Diagnosis:** No DCS

**Treatment:** None, just self-monitoring most likely with follow-up consultation.

### **Bends 7 (high exercise): Narratives but no DCS Assigned at JSC**

**7. Summary:** ID# 116-01, 33-year-old male, maximum Grade 4, first VGE at 0 minutes, did not report a symptom until after the test during debriefing period, study done on n = 11, crossover dependent sample statistical design.

#### **Procedure 14**

**Narrative:** At about 30 minutes after the test, subject mentioned during the formal debriefing that he had “something” once during the test but it was exactly what he feels in some cramped positions, so he did not report anything. First VGE detected at 0 minutes, Grade 0 from left arm, Grade 0 from left leg, Grade 3 from right arm, and Grade 0 from right leg. It is very unusual to detect VGE early in the exposure, and even more unusual to detect VGE exclusively from the upper body. There was a rapid onset of VGE, with Grade 4 from the left and right legs at 96 minutes into the test. Last VGE record at 189 minutes with Grade 0 from left arm, Grade 3 from left leg, Grade 3 from right arm, and Grade 4 from right leg. Subject did not report if there was a change in symptoms during descent.

**Diagnosis:** No DCS

**Treatment:** One-hr GLO with follow-up consultation.

### **Bends 7 (low exercise): Narratives but no DCS Assigned at JSC**

**8. Summary:** ID# 123-02, 28-year-old male, maximum Grade 4, first VGE at 76 minutes, first report at 120 minutes, study done on n = 11, crossover dependent sample statistical design.

## **Procedure 15**

**Narrative:** At 120 minutes, during 2<sup>nd</sup>-hr questioning, subject reported tingling on skin of face, shoulders, and wrists. He also mentioned being intermittently warm. Did not report initial pain score on the 1–10 scale. First VGE detected at 76 minutes, Grade 0 from left arm, Grade 1 from left leg, Grade 0 from right arm, and Grade 1 from right leg. Last VGE record at 185 minutes with Grade 0 from left arm, Grade 3 from left leg, Grade 0 from right arm, and Grade 2 from right leg. At 3<sup>rd</sup>-hr questioning, subject said all skin sensations had disappeared about 30 minutes earlier. There were no symptoms prior to descent; symptoms resolved at the test altitude of 6.5 psia. Debrief notes indicate there was no rash on inspection of skin, and that symptoms could have been due to sweating early in the test.

**Diagnosis:** No DCS

**Treatment:** One-hr GLO with follow-up consultation .

## **Bends 8a (no prior treadmill exercise): Narratives but no DCS Assigned at JSC**

**9. Summary:** ID# 122-03, 48-year-old male, maximum Grade 4, first VGE at 24 minutes, first report at 120 minutes, study done on n = 40, crossover dependent sample statistical design.

## **Procedure 16**

**Narrative:** At 120 minutes, during 2<sup>nd</sup>-hr questioning, subject reported a warm head and forearm muscle stiffness during the Pull Station exercises. Did not provide initial pain score on a 1–10 scale. Subject and DT had reported being warm about 20 minutes into the test. At 150 minutes, subject reported that stiffness in forearms was about the same, and that they felt a little sore. At 160 minute,s subject reported a sinus headache localized to the ethmoid sinus. Headache was gradual in its onset, and subject felt it was related to O<sub>2</sub> flow in the mask. At 174 minutes, sinuses still hurt, mostly around the eyes. No visual disturbances mentioned. First VGE detected at 24 minutes, Grade 2 from left arm, Grade 3 from left leg, Grade 0 from right arm, and Grade 0 from right leg. Last VGE record at 168 minutes with Grade 2 from left arm, Grade 4 from left leg, Grade 2 from right arm, and Grade 4 from right leg. During repressurization, subject reported that his sinuses hurt more than at 6.5 psia. Chamber descent was stopped at 2,000 feet returned to 3,000 feet, and a sinus spray was administered to help open the sinuses. During debrief, subject was asked to pull on the Pull Station ergometer; he noted that his forearms still hurt a little, but not as much as at altitude. It is noted in the logbook that the Pull Station ergometer resistance was higher than the training ergometer in the Environmental Physiology Laboratory. Sinusitis improved.

**Diagnosis:** No DCS

**Treatment:** One-hr GLO with follow-up consultation.

## **Bends 8b (prior treadmill exercise): Narratives but no DCS Assigned at JSC**

**10. Summary:** ID# 51-12, 32-year-old male, maximum Grade 1, first VGE at 175 minutes, first report at 60 minutes, study done on n = 41, crossover dependent sample statistical design.

### **Procedure 17**

**Narrative:** At 60 minutes, during 1<sup>st</sup>-hr questioning, subject reported slight pain in right elbow. Reported initial pain score of 1 on a 1–10 scale. Pain was described as steady, and did not change with exercise. Subject mentioned that he had not experienced this sensation during ground training of the exercise activities. First VGE detected at 175 minutes, Grade 0 from left arm, Grade 1 from left leg, Grade 0 from right arm, and Grade 0 from right leg. Last VGE record was also at 175 minutes with Grade 0 from left arm, Grade 1 from left leg, Grade 0 from right arm, and Grade 0 from right leg. This was the only incident of a detected VGE. At 76 minutes, subject reported no change in right elbow symptoms, which were localized right on the elbow, were not sensitive to touch, and were described as a mild ache. At 91 minutes, in response to a query by the test investigator, subject said that sensation in right elbow had all but disappeared. At 2<sup>nd</sup>- and 3<sup>rd</sup>-hr questioning, subject had nothing to report about his right elbow. There were no symptoms prior to descent; symptoms resolved at the test altitude of 6.5 psia.

**Diagnosis:** No DCS

**Treatment:** One-hr GLO with follow-up consultation.

## **Bends 9a (ambulatory control): Narratives but no DCS Assigned at JSC**

**11. Summary:** ID# 145-04, 43-year-old male, maximum Grade 4, first VGE at 32 minutes, first report at 60 minutes, study done on n = 24, crossover dependent sample statistical design.

### **Procedure 18**

**Narrative:** At 60 minutes, during 1<sup>st</sup>-hr questioning, subject reported some lightheadedness and a slight headache. Did not report initial pain score on the 1–10 scale. At 2<sup>nd</sup>-hr questioning, subject reported that headache was gone, but still lightheaded. After this entry the logbook shows, in parentheses, “not as sharp as when first entered chamber.” It is not clear if this refers to lightheaded symptom. First VGE detected at 32 minutes, Grade 0 from left arm, Grade 1 from left leg, Grade 2 from right arm, and Grade 2 from right leg. Last VGE record at 175 minutes with Grade 0 from left arm, Grade 4 from left leg, Grade 1 from right arm, and Grade 4 from right leg. Subject experienced significant VGE from the start of test to the end of test. At 3<sup>rd</sup>-hr questioning, subject only reported being a little lethargic. Except for the lethargy, there were no symptoms of headache or lightheadedness prior to descent. The logbook does not document if there were any improvements during the descent. The Questionnaire on Post-Exposure Symptoms indicated that subject experienced nausea halfway through the test.

**Diagnosis:** No DCS

**Treatment:** One-hr GLO with follow-up consultation.

### **Phase I PRP: Narratives but no DCS Assigned at Duke**

**12. Summary:** ID# D980331A, 29-year-old male, maximum Grade 0, first report at 58 minutes, study done on n = 47, independent sample statistical design.

#### **Procedure 23**

**Narrative:** At 58 minutes and 116 minutes, subject reported unusual muscle twitches or spasms in left elbow and left forearm during flexion of the limbs for VGE measurements. Subject had no VGE. Last VGE record at 229 minutes with Grade 0 from right arm, Grade 0 from left arm, Grade 0 from left leg, and Grade 0 from right leg. There were no symptoms prior to descent; symptoms resolved at the test altitude of 4.3 psia.

**Diagnosis:** No DCS

**Treatment:** None, just self-monitoring with follow-up consultation.

**13. Summary:** ID# D980331B, 24-year-old male, maximum Grade 3, first VGE at 28 minutes, first report at 59 minutes, study done on n = 47, independent sample statistical design.

#### **Procedure 23**

**Narrative:** At 59 minutes, subject reported bilateral pain in hands extending from base of 5<sup>th</sup> digit proximally along ulnar aspect to wrist and dorsally to base of thumb. Reported initial pain score of 3 on a 1–10 scale. Pain was sharp during exercise (tension-release portion of the PS/AS2 station) and dull at a pain score of 1 during rest. Symptoms lasted for approximately 105 minutes before abating to a pain score of 0. The PS/AS2 exercise involved pulling and then holding pounds of force with isometric contraction in the arms, depending on your body weight, as well as flexing the lt and then rt arms across the chest against a resistance from bundge cord. First VGE detected at 28 minutes, Grade 0 from right arm, Grade 2 from left arm, Grade 0 from left leg, and Grade 2 from right leg. Last VGE record at 232 minutes with Grade 1 from right arm, Grade 0 from left arm, Grade 0 from left leg, and Grade 0 from right leg. There were no symptoms in the hands prior to descent; symptoms resolved at the test altitude of 4.3 psia.

**Diagnosis:** No DCS, determined to be induced by exercise.

**Treatment:** None, just self-monitoring with follow-up consultation.

### **Phase II PRP: Narratives but no DCS Assigned at Duke**

**14. Summary:** ID# D980526B, 22-year-old male, maximum Grade 0, first report at 48 minutes, study done on n = 45, independent sample statistical design.

## **Procedure 24**

**Narrative:** At 48 minutes, subject reported a dull, steady aching pain in right shin, lateral aspect. Reported initial pain score of 2 on a 1–10 scale. Subject had no VGE. Last VGE record at 233 minutes with Grade 0 from right arm, Grade 0 from left arm, Grade 0 from left leg, and Grade 0 from right leg. All symptoms were gone by 232 minutes. There were no symptoms in right shin prior to descent; symptoms resolved at the test altitude of 4.3 psia.

**Diagnosis:** No DCS, exercise-induced symptoms

**Treatment:** None, just self-monitoring with follow-up consultation.

**15. Summary:** ID# D980609A, 27-year-old male, maximum Grade 0, first report at 181 minutes, study done on n = 45, independent sample statistical design.

## **Procedure 24**

**Narrative:** At 181 minutes, subject reported a headache but did not mention this again during the exposure. Last VGE record at 241 minutes with Grade 0 from right arm, Grade 0 from left arm, Grade 0 from left leg, and Grade 0 from right leg. During evaluation at site pressure, subject volunteered an initial pain score of 4 on a 1–10 scale for the headache, and said that it had been a steady headache. He said that the headache decreased in severity during final descent, reaching approximately a 1–2 pain score after the test.

**Diagnosis:** No DCS. Subject was diagnosed with idiopathic headache.

**Treatment:** None, just self-monitoring with follow-up consultation. Instructed to take Motrin and to rehydrate.

## **Phase II PRP: Narratives but no DCS Assigned at Hermann**

**16. Summary:** ID# H980707A, 36-year-old female, maximum Grade 3, first VGE at 160 minutes, first report at 196 minutes, study done on n = 45, independent sample statistical design.

## **Procedure 24**

**Narrative:** At 196 minutes, subject reported intermittent pain on antecubital side of right arm. Reported initial pain score of 2–3 on a 1–10 scale. At 212 minutes, subject reported fatigue and pain in right arm was reduced to a pain score of 1. First VGE detected at 160 minutes, Grade 0 from right arm, Grade 0 from left arm, Grade 0 from left leg, and Grade 2 from right leg. Last VGE record at 228 minutes with Grade 0 from right arm, Grade 0 from left arm, Grade 0 from left leg, and Grade 3 from right leg. Subject finished the test, but reported that the pain did not resolve during descent. During a posttest interview by the MO, subject – while on 100% O<sub>2</sub> – described pain in right arm as more like an itch or a bee sting. NOTE: Subject had a hard time during the 10-minute exercise PB, and the resistance was reduced to almost half of the prescribed amount.

**Diagnosis:** No DCS. The MO attributed all the symptoms to muscle strain.

**Treatment:** One-hr GLO with follow-up consultation.

## **Phase II PRP: Narratives but no DCS Assigned at DCIEM**

**17. Summary:** ID# C980617A, 29-year-old male, maximum Grade 1, first VGE at 98 minutes, first report at 132 minutes, study done on n = 45, independent sample statistical design.

### **Procedure 24**

**Narrative:** At 132 minutes, subject reported awareness in hips. Awareness persisted for the remainder of the exposure. First VGE detected at 98 minutes, Grade 0 from right arm, Grade 0 from left arm, Grade 1 from left leg, and Grade 0 from right leg. Last VGE record at 234 minutes with Grade 0 from right arm, Grade 0 from left arm, Grade 0 from left leg, and Grade 0 from right leg. Subject finished test, but no details were provided about changing symptoms in hips during descent.

**Diagnosis:** No DCS

**Treatment:** None, just self-monitoring with follow-up consultation.

**18. Summary:** ID# C980617C, 46-year-old male, maximum Grade 4, first VGE at 78 minutes, first report at 128 minutes, study done on n = 45, independent sample statistical design.

### **Procedure 24**

**Narrative:** At 128 minutes, subject reported being suddenly tired. Fatigue was gone by 196 minutes. First VGE detected at 78 minutes, Grade 0 from right arm, Grade 0 from left arm, Grade 3 from left leg, and Grade 0 from right leg. Last VGE record at 231 minutes with Grade 1 from right arm, Grade 1 from left arm, Grade 4 from left leg, and Grade 2 from right leg. There were no symptoms prior to descent; symptoms resolved at the test altitude of 4.3 psia. NOTE: Subject had severely injured his left knee while skiing as a teenager. This was the limb with high VGE grades.

**Diagnosis:** No DCS

**Treatment:** None, just self-monitoring with follow-up consultation.

**19. Summary:** ID# C980625C, 46-year-old male, maximum Grade 4, first VGE at 26 minutes, first report at 90 minutes, study done on n = 45, independent sample statistical design.

### **Procedure 24**

**Narrative:** At 90 minutes, subject reported that left shoulder was a bit sore, had a dull ache, which was not pain, that did not interfere with activity. Reported initial pain score of 2 on a 1–10 scale. No symptoms were present during rest but were present during activity for the rest of the exposure. First VGE detected at 26 minutes, Grade 0 from right arm, Grade 2 from left arm, Grade 1 from left leg, and Grade 2 from right leg. Last VGE record at 230 minutes with Grade 3 from right arm, Grade 3 from left arm, Grade 3 from left leg, and Grade 2 from right leg. There

was questionable improvement in left shoulder on descent and during a test-of-pressure at 60 fsw for 10 minutes. On descent, he felt subjective improvement at 10.5 psia; but on questioning at site pressure, he stated that he felt there was no change during the descent.

**Diagnosis:** No DCS. Musculo-skeletal symptom. Had history of multiple joint symptoms.

**Treatment:** Trial of pressure to 60 fsw on O<sub>2</sub> for 10 minutes, and no change in shoulder symptom reported. Follow-up consultation the next day was done.

### **Phase III PRP: Narratives but no DCS Assigned at Duke**

**20. Summary:** ID# D980630A, 25-year-old female, maximum Grade 2, first VGE at 79 minutes, first report at 58 minutes, study done on n = 10, independent sample statistical design.

#### **Procedure 25**

**Narrative:** Subject reported lower dorsal and gluteal pain during surface interval prior to final ascent to 4.3 psia. Was given a pillow to improve lower body discomfort. At 59 minutes, subject reported lower back pain during exercise and while resting. Reported initial pain score of 1 on a 1–10 scale. At 112 minutes, pain was described as pain score of 2 during sit-ups. At 162 minutes, subject complained of pain score of 5 in same region and decision was made to return her to site pressure. First VGE detected at 79 minutes, Grade 0 from right arm, Grade 1 from left arm, Grade 1 from left leg, and Grade 2 from right leg. Last VGE record at 165 minutes with Grade 0 from right arm, Grade 0 from left arm, Grade 0 from left leg, and Grade 0 from right leg. She noted immediate relief of pain with standing in chamber during lockout preparation (before recompression), with resolution to pain score 1 by arrival at surface. Posttest examination uncovered no neurological signs or symptoms.

**Diagnosis:** No DCS. Musculoskeletal symptom.

**Treatment:** One-hr GLO with follow-up consultation.

**21. Summary:** ID# D980707B, 29-year-old male, maximum Grade 0, first report at 108 minutes, study done on n = 10, independent sample statistical design.

#### **Procedure 25**

**Narrative:** At 108 minutes, subject reported dull transient pain above left eye in frontal sinus region. Reported initial pain score of 3 on a 1–10 scale. Given Afrin and monitored for remainder of flight. Pain score reduced to a value of 1 within 10 minutes (about 118 minutes elapsed time). Little pain (pain score of 2) was experienced during percussion test at 140 minutes. Mild sinus discomfort persisted throughout the test and during descent, with a reported pain score of 0.5–1. Subject had no VGE. Last VGE record at 221 minutes with Grade 0 from right arm, Grade 0 from left arm, Grade 0 from left leg, and Grade 0 from right leg. Final descent was paused for 30 seconds at 6.65 psia to allow subject to clear ears. Posttest examination was unremarkable except for note of mild ear barotrauma.

**Diagnosis:** No DCS

**Treatment:** None, just self-monitoring with follow-up consultation.

**22. Summary:** ID# D980714B, 40-year-old male, maximum Grade 0, first report at 21 minutes, study done on n = 10, independent sample statistical design.

### **Procedure 25**

**Narrative:** At 21 minutes, subject reported steady tingling in right toes at rest. Reported initial pain score of 2 on a 1–10 scale. This sensation persisted for about 1 minute before it completely subsided. Subject had no VGE. Last VGE record at end of test with Grade 0 from right arm, Grade 0 from left arm, Grade 0 from left leg, and Grade 0 from right leg. There were no symptoms prior to descent; symptoms resolved at the test altitude of 4.3 psia.

**Diagnosis:** No DCS

**Treatment:** None, just self-monitoring with follow-up consultation.

### **Phase IV PRP: Narratives but no DCS Assigned at Duke**

**23. Summary:** ID# D990504C, 22-year-old male, maximum Grade 0, first report at 44 minutes, study done on n = 57, independent sample statistical design.

### **Procedure 26**

**Narrative:** At 44 minutes, subject reported dull, steady tingling in both legs. Reported initial pain score of 1 on a 1–10 scale. At 59 minutes, tingling was barely noticeable; a pain score of 0.5 was given, and a decision was made to remove subject due to persistence of symptom. Walking prior to lockout relieved symptoms. Subject had no VGE. Last VGE record at 40 minutes with Grade 0 from right arm, Grade 0 from left arm, Grade 0 from left leg, and Grade 0 from right leg. There were no symptoms prior to descent; symptoms resolved at the test altitude of 4.3 psia.

**Diagnosis:** No DCS

**Treatment:** None, just self-monitoring with follow-up consultation.

**24. Summary:** ID# D990525A, 27-year-old male, maximum Grade 0, first report at 590 minutes (10 h from start of test), study done on n = 57, independent sample statistical design.

### **Procedure 26**

**Narrative:** At 350 minutes (6 h) after the test, subject reported pain in lower back while seated. Reported initial pain score of 2 on a 1–10 scale with a sharp pain at a pain score of 6. Subject had no VGE. Last VGE record at 228 minutes with Grade 0 from right arm, Grade 0 from left arm, Grade 0 from left leg, and Grade 0 from right leg. There were no symptoms prior to descent from 4.3 psia.

**Diagnosis:** No DCS. Musculoskeletal pain.

**Treatment:** None, just self-monitoring with follow-up consultation.



## **Phase IV PRP: Narratives but no DCS Assigned at DCIEM**

**25. Summary:** ID# C990121A, 55-year-old male, maximum Grade 4, first VGE at 81 minutes, first report at 136 minutes, study done on n = 57, independent sample statistical design.

### **Procedure 26**

**Narrative:** At 136 minutes, subject reported mild ambiguous symptoms (awareness) in left proximal shin. First VGE detected at 81 minutes, Grade 0 from right arm, Grade 0 from left arm, Grade 3 from left leg, and Grade 0 from right leg. Last VGE record at 233 minutes with Grade 3 from right arm, Grade 3 from left arm, Grade 4 from left leg, and Grade 4 from right leg. There were no respiratory or left and right knee symptoms prior to descent; symptoms resolved at the test altitude of 4.3 psia. NOTE: Subject had mild upper respiratory tract symptoms the following morning. This developed into a severe cold over the weekend, and he only started getting better on Wednesday.

**Diagnosis:** No DCS

**Treatment:** None, just self-monitoring with follow-up consultation.

**26. Summary:** ID# C990121C, 40-year-old male, maximum Grade 4, first VGE at 93 minutes, first report at 136 minutes, study done on n = 57, independent sample statistical design.

### **Procedure 26**

**Narrative:** At 136 minutes, subject reported mild irritation on inspiration; suspected dry O<sub>2</sub>. At 168 minutes, subject reported ambiguous symptoms (mild sensation) in both knees. First VGE detected at 93 minutes, Grade 0 from right arm, Grade 0 from left arm, Grade 2 from left leg, and Grade 0 from right leg. Last VGE record at 229 minutes with Grade 3 from right arm, Grade 3 from left arm, Grade 4 from left leg, and Grade 4 from right leg. There were no symptoms prior to descent; symptoms resolved at the test altitude of 4.3 psia.

**Diagnosis:** No DCS

**Treatment:** None, just self-monitoring with follow-up consultation.

**27. Summary:** ID# C990303D, 37-year-old male, maximum Grade 4, first VGE at 130 minutes, first report was prior to ascent to 4.3 psia, study done on n = 57, independent sample statistical design.

### **Procedure 26**

**Narrative:** Subject reported generalized numbness in legs at 9.6 psia, and was told to move legs on a regular basis during the test at 4.3 psia. Numbness was attributed to the exercise cot. At 42 minutes, subject reported a sore right bicep; and at 94 minutes, he had cramps in both leg muscles. At 210 minutes, subject reported stiff legs. First VGE detected at 130 minutes, Grade 0 from right arm, Grade 0 from left arm, Grade 3 from left leg, and Grade 0 from right leg. Last

VGE record at 230 minutes with Grade 2 from right arm, Grade 1 from left arm, Grade 4 from left leg, and Grade 3 from right leg. No information was provided about change in symptoms during descent to site pressure. NOTE: Subject complained of minor backache and sore leg in the morning before the PB started, but the database narrative was not specific on which leg was sore.

**Diagnosis:** No DCS

**Treatment:** None, just self-monitoring with follow-up consultation.

**28. Summary:** ID# C990324A, 53-year-old male, maximum Grade 4, first VGE at 44 minutes, first report at 112 minutes, study done on n = 57, independent sample statistical design.

### **Procedure 26**

**Narrative:** At 112 minutes, subject reported slight awareness in both knees. This sensation had gone by the next Doppler measurement period (about 12 minutes). First VGE detected at 44 minutes, Grade 2 from right arm, Grade 1 from left arm, Grade 2 from left leg, and Grade 1 from right leg. Last VGE record at 232 minutes with Grade 0 from right arm, Grade 0 from left arm, Grade 3 from left leg, and Grade 3 from right leg. There were no symptoms in both knees prior to descent; symptoms resolved at the test altitude of 4.3 psia.

**Diagnosis:** No DCS

**Treatment:** None, just self-monitoring with follow-up consultation.

**29. Summary:** ID# C990331A, 37-year-old male, maximum Grade 4, first VGE at 82 minutes, first report at 114 minutes, study done on n = 57, independent sample statistical design.

### **Procedure 26**

**Narrative:** At 114 minutes, subject reported some discomfort in right knee, possibly from sitting. At 124 minutes, subject reported a pain score of 1 on the 1–10 pain scale and definite steady discomfort for right knee. At 138 minutes, there was still steady discomfort in right knee at a 1 on the pain score. At 154 minutes, subject reported no discomfort; symptom had completely resolved. First VGE detected at 82 minutes, Grade 0 from right arm, Grade 2 from left arm, Grade 0 from left leg, and Grade 2 from right leg. Last VGE record at 234 minutes with Grade 0 from right arm, Grade 0 from left arm, Grade 3 from left leg, and Grade 3 from right leg. There were no symptoms in right knee prior to descent; symptoms resolved at the test altitude of 4.3 psia.

**Diagnosis:** No DCS

**Treatment:** None, just self-monitoring with follow-up consultation.

**30. Summary:** ID# C990331C, 25-year-old female, maximum Grade 3, first VGE at 146 minutes, first report at 14 minutes, study done on n = 57, independent sample statistical design.

## **Procedure 26**

**Narrative:** At 14 minutes, subject reported some tingling, but disappearing. At 130 minutes, subject reported slight tingling in back only when doing sit-ups. By 146 minutes, the tingling sensations were subsiding. First VGE detected at 146 minutes, Grade 0 from right arm, Grade 0 from left arm, Grade 2 from left leg, and Grade 0 from right leg. Last VGE record at 230 minutes with Grade 0 from right arm, Grade 0 from left arm, Grade 3 from left leg, and Grade 0 from right leg. There were no symptoms of tingling in back prior to descent; symptoms resolved at the test altitude of 4.3 psia.

**Diagnosis:** No DCS

**Treatment:** None, just self-monitoring with follow-up consultation.

**31. Summary:** ID# C990331D, 28-year-old female, maximum Grade 0, first report at 214 minutes, study done on n = 57, independent sample statistical design.

## **Procedure 26**

**Narrative:** At 214 minutes, subject reported momentary tingling in left foot. Subject had no VGE. Last VGE record at 230 minutes with Grade 0 from right arm, Grade 0 from left arm, Grade 0 from left leg, and Grade 0 from right leg. No VGE during the run. There were no symptoms of tingling in left foot prior to descent; symptoms resolved at the test altitude of 4.3 psia.

**Diagnosis:** No DCS

**Treatment:** None, just self-monitoring with follow-up consultation.

## **Phase IV PRP: Narratives but no DCS Assigned at Hermann**

**32. Summary:** ID# H990615A, 22-year-old male, maximum Grade 0, first report at 157 minutes, study done on n = 57, independent sample statistical design.

## **Procedure 26**

**Narrative:** At 157 minutes, subject reported forearm numbness. Sensation improved but with a decreased sensation of an area of 2 in. × 6 in. described. Subject did not have decreased grip strength and felt fine after interview with MO. At approximately 210 minutes, subject reported bilateral forearm numbness that extended to wrists bilaterally. A decision was made to remove subject from the test. Subject had no VGE. Last VGE record at 145 minutes with Grade 0 from right arm, Grade 0 from left arm, Grade 0 from left leg, and Grade 0 from right leg. Symptoms did not resolve on return to site pressure, but numbness may have improved. On pinprick testing, bilateral forearms had decreased pinprick, as well as thenar eminence bilaterally. Soft touch was also reduced. However, muscle strength was 5/5 in all groups, and reflexes were completely normal, both upper and lower. After 15 minutes (on sea level O<sub>2</sub>, as per protocol), subject still complained of tingling of bilateral forearms, although decreased pinprick was completely resolved. Due to persistent subjective numbness, it was decided to provide a hyperbaric treatment.

**Diagnosis:** No DCS. A mild case of bilateral median nerve irritation due to repetitive muscle activity was diagnosed. Due to the fact that there symptoms were bilateral, did not appear to improve in direct relation to recompression (either to sea level or at 60 fsw), and were all referable to the median nerve, it was the opinion of the MO that this was not DCS, but was bilateral median nerve irritation.

**Treatment:** USN HBO TT VI for possible neurological DCS, with no relief with compression to 60 fsw. After the first O<sub>2</sub> cycle, all subjective symptoms of tingling had resolved. This treatment was complicated by the fact that symptoms were improving when subject first entered the treatment chamber. He had no problems with TT VI, and had neither subjective nor objective neurological complaints after treatment. Follow-up consultation the next day was done.

## Appendix V: Prebreathe and Test Details

**Procedure 1 (Test 1a):** A 3.5-hr O<sub>2</sub> PB at 14.7 psia prior to 3-hr exposure to 4.3 psia in the ETA, an altitude chamber configured to resemble the Shuttle crew compartment. Decompression required 6 minutes at 5,000 feet/minute. Exercise stressed lower body. Exercise was 4 minutes of flexing elbow and shoulder joints by rhythmically lifting a 1.36-kg weight alternately every 5 seconds from left to right hand, 4 minutes flexing hip and knee joints by rhythmically stepping on an 18.4-cm step once every 10 seconds, 4 minutes sitting or standing with no physical activity, and 4 minutes in a supine position while flexing arms and legs sequentially to improve bubble detection by DT. Each limb was flexed 3 times along with wrist and ankle rotation. Subjects used these devices from a standing or seated (non-adyamic) position and were allowed to walk during PB or altitude exposure. Test termination for DCS was after any performance was affected; but during Bends 1, the MO always stopped the test once DCS was diagnosed.

**Procedure 2 (Test 1b):** Twelve h at 10.2 psia plus a 40-minute O<sub>2</sub> PB prior to a 3-hr exposure to 4.3 psia in the ETA, an altitude chamber configured to resemble the Shuttle crew compartment. Decompression required 2 minutes on air to 10.2 psia and 4 minutes to 4.3 psia after the final PB, all at 5,000 feet/minute. Exercise stressed lower body. Gas composition at 10.2 psia was nominal 26.5% O<sub>2</sub> - 73.5% N<sub>2</sub>, but protocol records indicated 27% O<sub>2</sub> was the goal. Exercise was 4 minutes flexing elbow and shoulder joints by rhythmically lifting a 1.36-kg weight alternately every 5 seconds from left to right hand, 4 minutes flexing hip and knee joints by rhythmically stepping on an 18.4-cm step once every 10 seconds, 4 minutes sitting or standing with no physical activity, and 4 minutes in a supine position while flexing arms and legs sequentially to improve bubble detection by DT. Each limb was flexed 3 times along with wrist and ankle rotation. Subjects used these devices from a standing or seated (non-adyamic) position and were allowed to walk during PB or altitude exposure. Test termination for DCS was after any performance was affected; but during Bends 1, the MO always stopped the test once DCS was diagnosed.

**Procedure 3 (Test 1c):** Twelve h at 10.2 plus a 90-minute O<sub>2</sub> PB prior to a 3-hr exposure to 4.3 psia in the ETA, an altitude chamber configured to resemble the Shuttle crew compartment. Decompression required 2 minutes on air to 10.2 psia and 4 minutes to 4.3 psia after the final PB, all at 5,000 feet/minute. Gas composition at 10.2 psia was nominal 26.5% O<sub>2</sub> - 73.5% N<sub>2</sub>, but protocol records indicated 27% O<sub>2</sub> was the goal. The exercise was 4 minutes flexing elbow and shoulder joints by rhythmically lifting a 1.36 kg-weight alternately every 5 seconds from left to right hand, 4 minutes flexing hip and knee joints by rhythmically stepping on an 18.4-cm step once every 10 seconds, 4 minutes sitting or standing with no physical activity, and 4 minutes in a supine position while flexing arms and legs sequentially to improve bubble detection by DT. Each limb was flexed 3 times along with wrist and ankle rotation. Subjects used these devices from a standing or seated (non-adyamic) position and were allowed to walk during PB or altitude exposure. Test termination for DCS was after any performance was affected; but during Bends 1. The MO always stopped the test once DCS was diagnosed.

**Procedure 4 (Test 1d):** Eighteen h at 10.2 psia plus a 40-minute O<sub>2</sub> PB prior to a 3-hr exposure to 4.3 psia in the ETA, an altitude chamber configured to resemble the Shuttle crew compartment. Decompression required 2 minutes on air to 10.2 psia and 4 minutes to 4.3 psia after the final PB, all at 5,000 feet/minute. Exercise stressed lower body. Gas composition at

10.2 psia was nominal 26.5% O<sub>2</sub> - 73.5% N<sub>2</sub>, but protocol records indicated 27% O<sub>2</sub> was the goal. The exercise was 4 minutes flexing elbow and shoulder joints by rhythmically lifting a 1.36-kg weight alternately every 5 seconds from left to right hand, 4 minutes flexing hip and knee joints by rhythmically stepping on an 18.4-cm step once every 10 seconds, 4 minutes sitting or standing with no physical activity, and 4 minutes in a supine position while flexing arms and legs sequentially to improve bubble detection by DT. Each limb was flexed 3 times along with wrist and ankle rotation. Subjects used these devices from a standing or seated (non-adiynamic) position and were allowed to walk during PB or altitude exposure. Test termination for DCS was after any performance was affected; but during Bends 1, the MO always stopped the test once DCS was diagnosed.

**Procedure 5 (Test 2a):** A 3.5-hr O<sub>2</sub> PB at 14.7 psia prior to a 4-hr exposure to 4.3 psia in the ETA, an altitude chamber configured to resemble the Shuttle crew compartment. Decompression was gradual and allowed 30 minutes of additional O<sub>2</sub> PB prior to reaching 4.3 psia. The detailed ascent profile is: 6 minutes to travel from 14.7 psia to 9.2 psia, a hold at 9.2 psia for 10 minutes, 4 minutes to travel from 9.2 psia to 5.2 psia, and finally 10 minutes to travel from 5.2 psia to 4.3 psia. Simulated EVA work activity and VGE monitoring began at 5.2 psia during the final 10-min pressure decrease to 4.3 psia. Since this defines the beginning of the simulated EVA, the additional 10 min of prebreathe during the final ascent is not considered as prebreathe time. The exercise stressed the upper body. “A” cycle exercise included 4 minutes seated at mini-gym set to 16.7 kg of resistance and pulling once in 5 seconds with right arm then pulling once in 5 seconds with the left arm, 4 minutes standing at ergometer set to 5-N resistance and cranking 3 times in 5 seconds with right hand going clockwise. A 5-second rest was taken, then 3 cranks repeated, 4 minutes standing at torque station 107 cm above floor where ten 3/8-in. fixed studs were torqued to 400 cm-kg. Torque was held for 5 seconds in both directions. A total of 24 separate isotonic torques were done in the 2- to 3-minute periods. Remaining time was spent stressing the wrist with a ball ratchet placed on several studs and maintaining an isotonic torque for 5 seconds. “A” cycle was to use the right hand with the ball ratchet, and finally 4 minutes in a supine position while flexing arms and legs sequentially to improve bubble detection by DT. Each limb was flexed 3 times along with wrist and ankle rotation. “B” cycle exercise included 4 minutes at mini-gym set to the same resistance as “A” cycle and pulling twice in a 5-second period, 4 minutes at ergometer using same rate except using left hand and cranking counterclockwise, 4 minutes at torque station using same torque pattern except with left hand, 4 minutes rest after completing “B” cycle, and finally 4 minutes in a supine position while flexing arms and legs sequentially to improve bubble detection by DT. Subjects used these devices from a standing or seated (non-adiynamic) position and were allowed to walk during PB or altitude exposure. Test termination for DCS was after any performance was affected.

**Procedure 6 (Test 2b):** Twelve h at 10.2 psia plus a 40-minute O<sub>2</sub> PB prior to a 4-hr exposure to 4.3 psia in the ETA, an altitude chamber configured to resemble the Shuttle crew compartment. Decompression was gradual and allowed 25 minutes of additional O<sub>2</sub> PB prior to reaching 4.3 psia after the stay at 10.2 psia. The detailed ascent profile is: 5 minutes to travel from 14.7 psia to 10.2 psia on air, then the 12 hr stay at 10.2 psia, plus the 40-minute O<sub>2</sub> PB. There was a 1 minute travel from 10.2 psia to 9.2 psia, a hold at 9.2 psia for 10 minutes, 4 minutes to travel from 9.2 psia to 5.2 psia, and finally 10 minutes to travel from 5.2 psia to 4.3 psia, all on 100% O<sub>2</sub>. Simulated EVA work activity and VGE monitoring began at 5.2 psia during the final 10-

min pressure decrease to 4.3 psia. Since this defines the beginning of the simulated EVA, the additional 10 min of prebreathe during the final ascent is not considered as prebreathe time. Exercise stressed the upper body. Gas composition at 10.2 psia was nominal 26.5% O<sub>2</sub> - 73.5% N<sub>2</sub>, but protocol records indicated 27% O<sub>2</sub> was the goal. "A" cycle exercise included 4 minutes seated at mini-gym set to 16.7 kg of resistance and pulling once in 5 seconds with right arm then pulling once in 5 seconds with the left arm, 4 minutes standing at ergometer set to 5-N resistance and cranking 3 times in 5 seconds with right hand going clockwise. A 5-second rest was taken, then 3 cranks repeated, 4 minutes standing at torque station 107 cm above floor where ten 3/8-in. fixed studs were torqued to 400 cm-kg. Torque was held for 5 seconds in both directions. A total of 24 separate isotonic torques were done in the 2- to 3-minute periods. Remaining time was spent stressing the wrist with a ball ratchet placed on several studs and maintaining an isotonic torque for 5 seconds. "A" cycle was to use the right hand with the ball ratchet, and finally 4 minutes in a supine position while flexing arms and legs sequentially to improve bubble detection by DT. Each limb was flexed 3 times along with wrist and ankle rotation. "B" cycle exercise included 4 minutes at mini-gym set to the same resistance as "A" cycle and pulling twice in a 5-second period, 4 minutes at ergometer using same rate except using left hand and cranking counterclockwise, 4 minutes at torque station using same torque pattern except with left hand, 4 minutes rest after completing "B" cycle, and finally 4 minutes in a supine position while flexing arms and legs sequentially to improve bubble detection by DT. Subjects used these devices from a standing or seated (non-adyamic) position and were allowed to walk during PB or altitude exposure. Test termination for DCS was after any performance was affected.

**Procedure 7 (Test 3a):** Subject was sequestered in a trailer at JSC for about 13 h, starting at 17:00 the day prior to the start of the test. A 4-hr O<sub>2</sub> PB at 14.7 psia prior to a 6-hr exposure to 4.3 psia in the ETA, an altitude chamber configured to resemble the Shuttle crew compartment. Decompression was gradual and allowed 30 minutes of additional O<sub>2</sub> PB prior to reaching 4.3 psia. The detailed ascent profile is: 6 minutes to travel from 14.7 psia to 9.2 psia, a hold at 9.2 psia for 10 minutes, 4 minutes to travel from 9.2 psia to 5.2 psia, and finally 10 minutes to travel from 5.2 psia to 4.3 psia. Simulated EVA work activity and VGE monitoring began at 5.2 psia during the final 10-min pressure decrease to 4.3 psia. Since this defines the beginning of the simulated EVA, the additional 10 min of prebreathe during the final ascent is not considered as prebreathe time. Exercise stressed the upper body. "A" cycle exercise included 4 minutes seated at mini-gym set to 16.7 kg of resistance and pulling once in 5 seconds with right arm then pulling once in 5 seconds with the left arm, 4 minutes standing at ergometer set to 5-N resistance and cranking 3 times in 5 seconds with right hand going clockwise. A 5-second rest was taken, then 3 cranks repeated, 4 minutes standing at torque station 107 cm above floor where ten 3/8-in. fixed studs were torqued to 400 cm-kg. Torque was held for 5 seconds in both directions. A total of 24 separate isotonic torques were done in the 2- to 3-minute periods. Remaining time was spent stressing the wrist with a ball ratchet placed on several studs and maintaining an isotonic torque for 5 seconds. "A" cycle was to use the right hand with the ball ratchet, and finally 4 minutes in a supine position while flexing arms and legs sequentially to improve bubble detection by DT. Each limb was flexed 3 times along with wrist and ankle rotation. "B" cycle exercise included 4 minutes at mini-gym set to the same resistance as "A" cycle and pulling twice in a 5-second period, 4 minutes at ergometer using same rate except using left hand and cranking counterclockwise, 4 minutes at torque station using same torque pattern except with left hand, 4 minutes rest after completing "B" cycle, and finally 4 minutes in a supine position while flexing arms and legs sequentially to improve bubble detection by DT.

An additional 16 minutes of rest after 3 h of exercise was given to exercising subjects and DT due to altitude duration. Water was available only during the 6-hr chamber exposures. Subjects used these devices from a standing or seated (non-adynamic) position and were allowed to walk during PB or altitude exposure. Test termination for DCS was after any performance was affected.

**Procedure 8 (Test 3b):** Subject was sequestered in a trailer at JSC for about 24 h, starting at 17:00 the day prior to the start of the test. A 60-minute O<sub>2</sub> PB at 14.7 psia was followed by 12 h at 10.2 psia plus an additional 40-minute O<sub>2</sub> PB prior to a 6-hr exposure to 4.3 psia in the ETA, an altitude chamber configured to resemble the Shuttle crew compartment. Decompression was gradual and allowed 25 minutes of additional O<sub>2</sub> PB prior to reaching 4.3 psia. The detailed ascent profile is: 45 minutes of the 60 minute initial PB was completed prior to a 15 minute travel from 14.7 psia to 10.2 psia on O<sub>2</sub>, then the 12 hr stay at 10.2 psia, plus the 40-minute O<sub>2</sub> PB. There was a 1 minute travel from 10.2 psia to 9.2 psia, a hold at 9.2 psia for 10 minutes, 4 minutes to travel from 9.2 psia to 5.2 psia, and finally 10 minutes to travel from 5.2 psia to 4.3 psia, all on 100% O<sub>2</sub>. Simulated EVA work activity and VGE monitoring began at 5.2 psia during the final 10-min pressure decrease to 4.3 psia. Since this defines the beginning of the simulated EVA, the additional 10 min of prebreathe during the final ascent is not considered as prebreathe time. Exercise stressed the upper body. Gas composition at 10.2 psia was nominal 26.5% O<sub>2</sub> - 73.5% N<sub>2</sub>, but protocol records indicated 27% O<sub>2</sub> was the goal. “A” cycle exercise included 4 minutes seated at mini-gym set to 16.7 kg of resistance and pulling once in 5 seconds with right arm then pulling once in 5 seconds with the left arm, 4 minutes standing at ergometer set to 5-N resistance and cranking 3 times in 5 seconds with right hand going clockwise. A 5-second rest was taken, then 3 cranks repeated, 4 minutes standing at torque station 107 cm above floor where ten 3/8-in. fixed studs were torqued to 400 cm-kg. Torque was held for 5 seconds in both directions. A total of 24 separate isotonic torques were done in the 2- to 3-minute periods. Remaining time was spent stressing the wrist with a ball ratchet placed on several studs and maintaining an isotonic torque for 5 seconds. “A” cycle was to use the right hand with the ball ratchet, and finally 4 minutes in a supine position while flexing arms and legs sequentially to improve bubble detection by DT. Each limb was flexed 3 times along with wrist and ankle rotation. “B” cycle exercise included 4 minutes at mini-gym set to the same resistance as “A” cycle and pulling twice in a 5-second period, 4 minutes at ergometer using same rate except using left hand and cranking counterclockwise, 4 minutes at torque station using same torque pattern except with left hand, 4 minutes rest after completing “B” cycle, and finally 4 minutes in a supine position while flexing arms and legs sequentially to improve bubble detection by DT. An additional 16 minutes of rest after 3 h of exercise was given to exercising subjects and DT due to altitude duration. Water was available only during the 6-hr chamber exposures. Subjects used these devices from a standing or seated (non-adynamic) position and were allowed to walk during PB or altitude exposure. Test termination for DCS was after any performance was affected.

**Procedure 9 (Test 3c):** This was the second of 2 decompressions, the first being Test 3a. Subjects returned to 14.7 psia for 13 h, a period of time spent sequestered in a trailer at JSC. Fourteen of 28 subjects from Test 3a repeated the protocol after a 13-hr interval on air at 14.7 psia. The total time on 100% O<sub>2</sub> from Test 3a, including 6 h simulated EVA and 6 minutes repressurization to 14.7 psia, and the intervening 13 h on air is carried over as part of the PB for



this test since there is some benefit from the initial PB. After 13 h on air the subjects performed a 4-hr O<sub>2</sub> PB at 14.7 psia prior to a 6-hr exposure to 4.3 psia in the ETA, an altitude chamber configured to resemble the Shuttle crew compartment. Decompression was gradual and allowed 30 minutes of additional O<sub>2</sub> PB prior to reaching 4.3 psia. The detailed ascent profile is: 6 minutes to travel from 14.7 psia to 9.2 psia, a hold at 9.2 psia for 10 minutes, 4 minutes to travel from 9.2 psia to 5.2 psia, and finally 10 minutes to travel from 5.2 psia to 4.3 psia. Simulated EVA work activity and VGE monitoring began at 5.2 psia during the final 10-min pressure decrease to 4.3 psia. Since this defines the beginning of the simulated EVA, the additional 10 min of prebreathe during the final ascent is not considered as prebreathe time. Exercise stressed the upper body. “A” cycle exercise included 4 minutes seated at mini-gym set to 16.7 kg of resistance and pulling once in 5 seconds with right arm then pulling once in 5 seconds with the left arm, 4 minutes standing at ergometer set to 5-N resistance and cranking 3 times in 5 seconds with right hand going clockwise. A 5-second rest was taken, then 3 cranks repeated, 4 minutes standing at torque station 107 cm above floor where ten 3/8-in. fixed studs were torqued to 400 cm-kg. Torque was held for 5 seconds in both directions. A total of 24 separate isotonic torques were done in the 2- to 3-minute periods. Remaining time was spent stressing the wrist with a ball ratchet placed on several studs and maintaining an isotonic torque for 5 seconds. “A” cycle was to use the right hand with the ball ratchet, and finally 4 minutes in a supine position while flexing arms and legs sequentially to improve bubble detection by DT. Each limb was flexed 3 times along with wrist and ankle rotation. “B” cycle exercise included 4 minutes at mini-gym set to the same resistance as “A” cycle and pulling twice in a 5-second period, 4 minutes at ergometer using same rate except using left hand and cranking counterclockwise, 4 minutes at torque station using same torque pattern except with left hand, 4 minutes rest after completing “B” cycle, and finally 4 minutes in a supine position while flexing arms and legs sequentially to improve bubble detection by DT. An additional 16 minutes of rest after 3 h of exercise was given to exercising subjects and DT due to the altitude duration. Water was available only during the 6-hr chamber exposures. Subjects used these devices from a standing or seated (non-adiynamic) position and were allowed to walk during PB or altitude exposure. Test termination for DCS was after any performance was affected.

**Procedure 10 (Test 3d):** This was the second of 2 decompressions, the first being Test 3b. Subjects returned to 10.2 psia in the ETA, an altitude chamber configured to resemble the Shuttle crew compartment, for 16 h and 20 minutes. Twelve of 35 subjects from Test 3b repeated the protocol after 16 h and 20 minutes at 10.2 psia. The total time on 100% O<sub>2</sub> from Test 3b, including 6 h simulated EVA and 6 minutes repressurization to 10.2 psia, and the intervening 16 h and 20 minutes at 10.2 psia is carried over as part of the PB for this test since there is some benefit from the initial PB. After 16 h and 20 minutes at 10.2 psia the subjects performed a 40 min O<sub>2</sub> PB. Decompression was gradual and allowed 25 minutes of additional O<sub>2</sub> PB prior to reaching 4.3 psia. The detailed ascent profile is: a 1 minute travel from 10.2 psia to 9.2 psia, a hold at 9.2 psia for 10 minutes, 4 minutes to travel from 9.2 psia to 5.2 psia, and finally 10 minutes to travel from 5.2 psia to 4.3 psia, all on 100% O<sub>2</sub>. Simulated EVA work activity and VGE monitoring began at 5.2 psia during the final 10-min pressure decrease to 4.3 psia. Since this defines the beginning of the simulated EVA, the additional 10 min of prebreathe during the final ascent is not considered as prebreathe time. Exercise stressed the upper body. Gas composition at 10.2 psia was nominal 26.5% O<sub>2</sub> - 73.5% N<sub>2</sub>, but protocol records indicated 27% O<sub>2</sub> was the goal. “A” cycle exercise included 4 minutes seated at mini-gym set to 16.7 kg of

resistance and pulling once in 5 seconds with right arm then pulling once in 5 seconds with the left arm, 4 minutes standing at ergometer set to 5-N resistance and cranking 3 times in 5 seconds with right hand going clockwise. A 5-second rest was taken, then 3 cranks repeated, 4 minutes standing at torque station 107 cm above floor where ten 3/8-in. fixed studs were torqued to 400 cm-kg. Torque was held for 5 seconds in both directions. A total of 24 separate isotonic torques were done in the 2- to 3-minute periods. Remaining time was spent stressing the wrist with a ball ratchet placed on several studs and maintaining an isotonic torque for 5 seconds. "A" cycle was to use the right hand with the ball ratchet, and finally 4 minutes in a supine position while flexing arms and legs sequentially to improve bubble detection by DT. Each limb was flexed 3 times along with wrist and ankle rotation. "B" cycle exercise included 4 minutes at mini-gym set to the same resistance as "A" cycle and pulling twice in a 5-second period, 4 minutes at ergometer using same rate except using left hand and cranking counterclockwise, 4 minutes at torque station using same torque pattern except with left hand, 4 minutes rest after completing "B" cycle, and finally 4 minutes in a supine position while flexing arms and legs sequentially to improve bubble detection by DT. An additional 16 minutes of rest after 3 h of exercise was given to exercising subjects and DT due to the altitude duration. Water was available only during the 6-hr chamber exposures. Subjects used these devices from a standing or seated (non-adiabatic) position and were allowed to walk during PB or altitude exposure. Test termination for DCS was after any performance was affected.

**Procedure 11 (Test 4a):** A 60-minute O<sub>2</sub> PB at 14.7 psia was followed by 12 h at 10.2 psia plus an additional 40-minute O<sub>2</sub> PB prior to a 3-hr exposure to 4.3 psia in the ETA, an altitude chamber configured to resemble the Shuttle crew compartment. This was the first of 2 exposures in the same day. Decompression was gradual and allowed 25 minutes of additional O<sub>2</sub> PB prior to reaching 4.3 psia. Gas composition at 10.2 psia was nominal 26.5% O<sub>2</sub> - 73.5% N<sub>2</sub>, but protocol records indicated 27% O<sub>2</sub> was the goal. The detailed ascent profile is: 45 minutes of the 60 minute initial PB was completed prior to a 15 minute travel from 14.7 psia to 10.2 psia on O<sub>2</sub>, then the 12 hr stay at 10.2 psia, plus the 40-minute O<sub>2</sub> PB. There was a 1 minute travel from 10.2 psia to 9.2 psia, a hold at 9.2 psia for 10 minutes, 4 minutes to travel from 9.2 psia to 5.2 psia, and finally 10 minutes to travel from 5.2 psia to 4.3 psia, all on 100% O<sub>2</sub>. Subjects returned to 10.2 psia in the ETA in 6 minutes. Simulated EVA work activity and VGE monitoring began at 5.2 psia during the final 10-min pressure decrease to 4.3 psia. Since this defines the beginning of the simulated EVA, the additional 10 min of prebreathe during the final ascent is not considered as prebreathe time. Exercise stressed the upper body. "A" cycle exercise included 4 minutes seated at mini-gym set to 16.7 kg of resistance and pulling once in 5 seconds with right arm then pulling once in 5 seconds with the left arm, 4 minutes standing at ergometer set to 5-N resistance and cranking 3 times in 5 seconds with right hand going clockwise. A 5-second rest was taken, then 3 cranks repeated, 4 minutes standing at torque station 107 cm above floor where ten 3/8-in. fixed studs were torqued to 400 cm-kg. Torque was held for 5 seconds in both directions. A total of 24 separate isotonic torques were done in the 2- to 3-minute periods. Remaining time was spent stressing the wrist with a ball ratchet placed on several studs and maintaining an isotonic torque for 5 seconds. "A" cycle was to use the right hand with the ball ratchet, and finally 4 minutes in a supine position while flexing arms and legs sequentially to improve bubble detection by DT. Each limb was flexed 3 times along with wrist and ankle rotation. "B" cycle exercise included 4 minutes at mini-gym set to the same resistance as "A" cycle and pulling twice in a 5-second period, 4 minutes at ergometer using same rate except

using left hand and cranking counterclockwise, 4 minutes at torque station using same torque pattern except with left hand, 4 minutes rest after completing “B” cycle, and finally 4 minutes in a supine position while flexing arms and legs sequentially to improve bubble detection by DT. Subjects used these devices from a standing or seated (non-adynamic) position and were allowed to walk during PB or altitude exposure. Test termination for DCS was after any performance was affected.

**Procedure 11a (Test 4b):** This was the second of 6 decompressions, the first being Test 4a. All previous PB and pressure-change history from Test 4a is carried forward plus the PB for this test. Subjects returned to 10.2 psia in the ETA in 6 minutes, an altitude chamber configured to resemble the Shuttle crew compartment, for 120 minutes. This was the second of 2 exposures on day 1 of 3. The twelve subjects repeated the ascent after 120 minutes at 10.2 psia. This was a scheduled lunch and bathroom break. The total time on 100% O<sub>2</sub> from Test 4a, including 3 h simulated EVA and 6 minutes repressurization to 10.2 psia, and the intervening 120 minutes at 10.2 psia is carried over as part of the PB for this test since there is some benefit from the initial PB. After 80 minutes at 10.2 psia the subjects performed a 40 min O<sub>2</sub> PB. Decompression was gradual and allowed 25 minutes of additional O<sub>2</sub> PB prior to reaching 4.3 psia. The detailed ascent profile is: a 1 minute travel from 10.2 psia to 9.2 psia, a hold at 9.2 psia for 10 minutes, 4 minutes to travel from 9.2 psia to 5.2 psia, and finally 10 minutes to travel from 5.2 psia to 4.3 psia, all on 100% O<sub>2</sub>. Simulated EVA work activity and VGE monitoring began at 5.2 psia during the final 10-min pressure decrease to 4.3 psia. Since this defines the beginning of the simulated EVA, the additional 10 min of prebreathe during the final ascent is not considered as prebreathe time. Exercise stressed the upper body. Gas composition at 10.2 psia was nominal 26.5% O<sub>2</sub> - 73.5% N<sub>2</sub>, but protocol records indicated 27% O<sub>2</sub> was the goal. “A” cycle exercise included 4 minutes seated at mini-gym set to 16.7 kg of resistance and pulling once in 5 seconds with right arm then pulling once in 5 seconds with the left arm, 4 minutes standing at ergometer set to 5-N resistance and cranking 3 times in 5 seconds with right hand going clockwise. A 5-second rest was taken, then 3 cranks repeated, 4 minutes standing at torque station 107 cm above floor where ten 3/8-in. fixed studs were torqued to 400 cm-kg. Torque was held for 5 seconds in both directions. A total of 24 separate isotonic torques were done in the 2- to 3-minute periods. Remaining time was spent stressing the wrist with a ball ratchet placed on several studs and maintaining an isotonic torque for 5 seconds. “A” cycle was to use the right hand with the ball ratchet, and finally 4 minutes in a supine position while flexing arms and legs sequentially to improve bubble detection by DT. Each limb was flexed 3 times along with wrist and ankle rotation. “B” cycle exercise included 4 minutes at mini-gym set to the same resistance as “A” cycle and pulling twice in a 5-second period, 4 minutes at ergometer using same rate except using left hand and cranking counterclockwise, 4 minutes at torque station using same torque pattern except with left hand, 4 minutes rest after completing “B” cycle, and finally 4 minutes in a supine position while flexing arms and legs sequentially to improve bubble detection by DT. An additional 16 minutes of rest after 3 h of exercise was given to exercising subjects and DT due to the altitude duration. Water was available only during the 6-hr chamber exposures. Subjects used these devices from a standing or seated (non-adynamic) position and were allowed to walk during PB or altitude exposure. Test termination for DCS was after any performance was affected.

**Procedure 11b (Test 4c):** This was the third of 6 decompressions. All previous PB and pressure-change history from Test 4a and 4b is carried forward plus the PB for this test. Subjects returned to 10.2 psia in the ETA in 6 minutes, an altitude chamber configured to resemble the Shuttle crew compartment, for 14 h. This was the first of 2 exposures on day 2 of 3. The twelve subjects repeated the ascent after 40 minutes of PB at 10.2 psia. Decompression was gradual and allowed 25 minutes of additional O<sub>2</sub> PB prior to reaching 4.3 psia. The detailed ascent profile is: a 1 minute travel from 10.2 psia to 9.2 psia, a hold at 9.2 psia for 10 minutes, 4 minutes to travel from 9.2 psia to 5.2 psia, and finally 10 minutes to travel from 5.2 psia to 4.3 psia, all on 100% O<sub>2</sub>. Simulated EVA work activity and VGE monitoring began at 5.2 psia during the final 10-min pressure decrease to 4.3 psia. Since this defines the beginning of the simulated EVA, the additional 10 min of prebreathe during the final ascent is not considered as prebreathe time. Exercise stressed the upper body. Gas composition at 10.2 psia was nominal 26.5% O<sub>2</sub> - 73.5% N<sub>2</sub>, but protocol records indicated 27% O<sub>2</sub> was the goal. “A” cycle exercise included 4 minutes seated at mini-gym set to 16.7 kg of resistance and pulling once in 5 seconds with right arm then pulling once in 5 seconds with the left arm, 4 minutes standing at ergometer set to 5-N resistance and cranking 3 times in 5 seconds with right hand going clockwise. A 5-second rest was taken, then 3 cranks repeated, 4 minutes standing at torque station 107 cm above floor where ten 3/8-in. fixed studs were torqued to 400 cm-kg. Torque was held for 5 seconds in both directions. A total of 24 separate isotonic torques were done in the 2- to 3-minute periods. Remaining time was spent stressing the wrist with a ball ratchet placed on several studs and maintaining an isotonic torque for 5 seconds. “A” cycle was to use the right hand with the ball ratchet, and finally 4 minutes in a supine position while flexing arms and legs sequentially to improve bubble detection by DT. Each limb was flexed 3 times along with wrist and ankle rotation. “B” cycle exercise included 4 minutes at mini-gym set to the same resistance as “A” cycle and pulling twice in a 5-second period, 4 minutes at ergometer using same rate except using left hand and cranking counterclockwise, 4 minutes at torque station using same torque pattern except with left hand, 4 minutes rest after completing “B” cycle, and finally 4 minutes in a supine position while flexing arms and legs sequentially to improve bubble detection by DT. An additional 16 minutes of rest after 3 h of exercise was given to exercising subjects and DT due to the altitude duration. Water was available only during the 6-hr chamber exposures. Subjects used these devices from a standing or seated (non-adyamic) position and were allowed to walk during PB or altitude exposure. Test termination for DCS was after any performance was affected.

**Procedure 11c (Test 4d):** This was the fourth of 6 decompressions. All previous PB and pressure-change history from Test 4a, 4b, and 4c is carried forward plus the PB for this test. Subjects returned to 10.2 psia in the ETA in 6 minutes, an altitude chamber configured to resemble the Shuttle crew compartment, for 120 minutes. This was the second of 2 exposures on day 2 of 3. The twelve subjects repeated the ascent after 120 minutes at 10.2 psia. This was a scheduled lunch and bathroom break. After 80 minutes at 10.2 psia the subjects performed a 40 min O<sub>2</sub> PB. Decompression was gradual and allowed 25 minutes of additional O<sub>2</sub> PB prior to reaching 4.3 psia. The detailed ascent profile is: a 1 minute travel from 10.2 psia to 9.2 psia, a hold at 9.2 psia for 10 minutes, 4 minutes to travel from 9.2 psia to 5.2 psia, and finally 10 minutes to travel from 5.2 psia to 4.3 psia, all on 100% O<sub>2</sub>. Simulated EVA work activity and VGE monitoring began at 5.2 psia during the final 10-min pressure decrease to 4.3 psia. Since this defines the beginning of the simulated EVA, the additional 10 min of prebreathe during the final ascent is not considered as prebreathe time. Exercise stressed the upper body. Gas

composition at 10.2 psia was nominal 26.5% O<sub>2</sub> - 73.5% N<sub>2</sub>, but protocol records indicated 27% O<sub>2</sub> was the goal. “A” cycle exercise included 4 minutes seated at mini-gym set to 16.7 kg of resistance and pulling once in 5 seconds with right arm then pulling once in 5 seconds with the left arm, 4 minutes standing at ergometer set to 5-N resistance and cranking 3 times in 5 seconds with right hand going clockwise. A 5-second rest was taken, then 3 cranks repeated, 4 minutes standing at torque station 107 cm above floor where ten 3/8-in. fixed studs were torqued to 400 cm-kg. Torque was held for 5 seconds in both directions. A total of 24 separate isotonic torques were done in the 2- to 3-minute periods. Remaining time was spent stressing the wrist with a ball ratchet placed on several studs and maintaining an isotonic torque for 5 seconds. “A” cycle was to use the right hand with the ball ratchet, and finally 4 minutes in a supine position while flexing arms and legs sequentially to improve bubble detection by DT. Each limb was flexed 3 times along with wrist and ankle rotation. “B” cycle exercise included 4 minutes at mini-gym set to the same resistance as “A” cycle and pulling twice in a 5-second period, 4 minutes at ergometer using same rate except using left hand and cranking counterclockwise, 4 minutes at torque station using same torque pattern except with left hand, 4 minutes rest after completing “B” cycle, and finally 4 minutes in a supine position while flexing arms and legs sequentially to improve bubble detection by DT. An additional 16 minutes of rest after 3 h of exercise was given to exercising subjects and DT due to the altitude duration. Water was available only during the 6-hr chamber exposures. Subjects used these devices from a standing or seated (non-dynamic) position and were allowed to walk during PB or altitude exposure. Test termination for DCS was after any performance was affected.

**Procedure 11d (Test 4e):** This was the fifth of 6 decompressions. All previous PB and pressure-change history from Test 4a, 4b, 4c, and 4d is carried forward plus the PB for this test. Subjects returned to 10.2 psia in the ETA in 6 minutes, an altitude chamber configured to resemble the Shuttle crew compartment, for 14 h. This was the first of 2 exposures on day 3 of 3. The twelve subjects repeated the ascent after 40 minutes of PB at 10.2 psia. Decompression was gradual and allowed 25 minutes of additional O<sub>2</sub> PB prior to reaching 4.3 psia. The detailed ascent profile is: a 1 minute travel from 10.2 psia to 9.2 psia, a hold at 9.2 psia for 10 minutes, 4 minutes to travel from 9.2 psia to 5.2 psia, and finally 10 minutes to travel from 5.2 psia to 4.3 psia, all on 100% O<sub>2</sub>. Simulated EVA work activity and VGE monitoring began at 5.2 psia during the final 10-min pressure decrease to 4.3 psia. Since this defines the beginning of the simulated EVA, the additional 10 min of prebreathe during the final ascent is not considered as prebreathe time. Exercise stressed the upper body. Gas composition at 10.2 psia was nominal 26.5% O<sub>2</sub> - 73.5% N<sub>2</sub>, but protocol records indicated 27% O<sub>2</sub> was the goal. “A” cycle exercise included 4 minutes seated at mini-gym set to 16.7 kg of resistance and pulling once in 5 seconds with right arm then pulling once in 5 seconds with the left arm, 4 minutes standing at ergometer set to 5-N resistance and cranking 3 times in 5 seconds with right hand going clockwise. A 5-second rest was taken, then 3 cranks repeated, 4 minutes standing at torque station 107 cm above floor where ten 3/8-in. fixed studs were torqued to 400 cm-kg. Torque was held for 5 seconds in both directions. A total of 24 separate isotonic torques were done in the 2- to 3-minute periods. Remaining time was spent stressing the wrist with a ball ratchet placed on several studs and maintaining an isotonic torque for 5 seconds. “A” cycle was to use the right hand with the ball ratchet, and finally 4 minutes in a supine position while flexing arms and legs sequentially to improve bubble detection by DT. Each limb was flexed 3 times along with wrist and ankle rotation. “B” cycle exercise included 4 minutes at mini-gym set to the same resistance as “A”

cycle and pulling twice in a 5-second period, 4 minutes at ergometer using same rate except using left hand and cranking counterclockwise, 4 minutes at torque station using same torque pattern except with left hand, 4 minutes rest after completing “B” cycle, and finally 4 minutes in a supine position while flexing arms and legs sequentially to improve bubble detection by DT. An additional 16 minutes of rest after 3 h of exercise was given to exercising subjects and DT due to the altitude duration. Water was available only during the 6-hr chamber exposures. Subjects used these devices from a standing or seated (non-adynamic) position and were allowed to walk during PB or altitude exposure. Test termination for DCS was after any performance was affected.

**Procedure 11e (Test 4f):** This was the sixth of 6 decompressions. All previous PB and pressure-change history from Test 4a, 4b, 4c, 4d, and 4e is carried forward plus the PB for this test. Subjects returned to 10.2 psia in the ETA in 6 minutes, an altitude chamber configured to resemble the Shuttle crew compartment, for 120 minutes. This was the second of 2 exposures on day 3 of 3. The twelve subjects repeated the ascent after 120 minutes at 10.2 psia. This was a scheduled lunch and bathroom break. After 80 minutes at 10.2 psia the subjects performed a 40 min O<sub>2</sub> PB. Decompression was gradual and allowed 25 minutes of additional O<sub>2</sub> PB prior to reaching 4.3 psia. The detailed ascent profile is: a 1 minute travel from 10.2 psia to 9.2 psia, a hold at 9.2 psia for 10 minutes, 4 minutes to travel from 9.2 psia to 5.2 psia, and finally 10 minutes to travel from 5.2 psia to 4.3 psia, all on 100% O<sub>2</sub>. Simulated EVA work activity and VGE monitoring began at 5.2 psia during the final 10-min pressure decrease to 4.3 psia. Since this defines the beginning of the simulated EVA, the additional 10 min of prebreathe during the final ascent is not considered as prebreathe time. Exercise stressed the upper body. Gas composition at 10.2 psia was nominal 26.5% O<sub>2</sub> - 73.5% N<sub>2</sub>, but protocol records indicated 27% O<sub>2</sub> was the goal. “A” cycle exercise included 4 minutes seated at mini-gym set to 16.7 kg of resistance and pulling once in 5 seconds with right arm then pulling once in 5 seconds with the left arm, 4 minutes standing at ergometer set to 5-N resistance and cranking 3 times in 5 seconds with right hand going clockwise. A 5-second rest was taken, then 3 cranks repeated, 4 minutes standing at torque station 107 cm above floor where ten 3/8-in. fixed studs were torqued to 400 cm-kg. Torque was held for 5 seconds in both directions. A total of 24 separate isotonic torques were done in the 2- to 3-minute periods. Remaining time was spent stressing the wrist with a ball ratchet placed on several studs and maintaining an isotonic torque for 5 seconds. “A” cycle was to use the right hand with the ball ratchet, and finally 4 minutes in a supine position while flexing arms and legs sequentially to improve bubble detection by DT. Each limb was flexed 3 times along with wrist and ankle rotation. “B” cycle exercise included 4 minutes at mini-gym set to the same resistance as “A” cycle and pulling twice in a 5-second period, 4 minutes at ergometer using same rate except using left hand and cranking counterclockwise, 4 minutes at torque station using same torque pattern except with left hand, 4 minutes rest after completing “B” cycle, and finally 4 minutes in a supine position while flexing arms and legs sequentially to improve bubble detection by DT. An additional 16 minutes of rest after 3 h of exercise was given to exercising subjects and DT due to the altitude duration. Water was available only during the 6-hr chamber exposures. Subjects used these devices from a standing or seated (non-adynamic) position and were allowed to walk during PB or altitude exposure. Test termination for DCS was after any performance was affected.

**Procedure 12 (Test 5a):** A 6-hr O<sub>2</sub> PB at 14.7 psia prior to a 6-hr exposure to 4.3 psia in the PTC. This was the first test to include females. Prior to ascent, a brief ear and sinus check was done by depressurizing the chamber atmosphere to the equivalent of 6,000 feet altitude in approximately 1 minute (5,000 feet/minute). Subject continued to breathe O<sub>2</sub> by mask during this check, which took about 5 minutes for subjects and DT to be evaluated, primarily during the repressurization back to site pressure. The medical technician exited the chamber, and ascent to the test altitude was initiated at 3,000 feet/min. Decompression required 10 minutes. Exercise stressed upper body. “A” cycle exercise included 4 minutes seated at mini-gym set to 16.7 kg of resistance and pulling once in 5 seconds with right arm then pulling once in 5 seconds with the left arm, 4 minutes standing at ergometer set to 5-N resistance and cranking 3 times in 5 seconds with right hand going clockwise. A 5-second rest was taken, then 3 cranks repeated, 4 minutes standing at torque station 107 cm above floor where ten 3/8-in. fixed studs were torqued to 400 cm-kg. Torque was held for 5 seconds in both directions. A total of 24 separate isotonic torques were done in the 2- to 3-minute periods. Remaining time was spent stressing the wrist with a ball ratchet placed on several studs and maintaining an isotonic torque for 5 seconds. “A” cycle was to use the right hand with the ball ratchet, and finally 4 minutes in a supine position while flexing arms and legs sequentially to improve bubble detection by DT. Each limb was flexed 3 times along with wrist and ankle rotation. “B” cycle exercise included 4 minutes at mini-gym set to the same resistance as “A” cycle and pulling twice in a 5-second period, 4 minutes at ergometer using same rate except using left hand and cranking counterclockwise, 4 minutes at torque station using same torque pattern except with left hand, 4 minutes rest after completing “B” cycle, and finally 4 minutes in a supine position while flexing arms and legs sequentially to improve bubble detection by DT. An additional 16 minutes of rest after 3 h of exercise was given to exercising subjects and DT due to altitude duration. Water was available only during the 6-hr chamber exposures. Subjects used these devices from a standing or seated (non-adiynamic) position and were allowed to walk during PB or altitude exposure. Test termination for DCS was after any performance was affected.

**Procedure 12a (Test 5b):** A 8-hr O<sub>2</sub> PB at 14.7 psia prior to a 6-hr exposure to 4.3 psia in the PTC. Prior to ascent, a brief ear and sinus check was done by depressurizing the chamber atmosphere to the equivalent of 6,000 feet altitude in approximately 1 minute (5,000 feet/minute). Subject continued to breathe O<sub>2</sub> by mask during this check, which took about 5 minutes for subjects and DT to be evaluated, primarily during the repressurization back to site pressure. The medical technician exited the chamber, and ascent to the test altitude was initiated at 3,000 feet/min. Decompression required 10 minutes. Exercise stressed upper body. “A” cycle exercise included 4 minutes seated at mini-gym set to 16.7 kg of resistance and pulling once in 5 seconds with right arm then pulling once in 5 seconds with the left arm, 4 minutes standing at ergometer set to 5-N resistance and cranking 3 times in 5 seconds with right hand going clockwise. A 5-second rest was taken, then 3 cranks repeated, 4 minutes standing at torque station 107 cm above floor where ten 3/8-in. fixed studs were torqued to 400 cm-kg. Torque was held for 5 seconds in both directions. A total of 24 separate isotonic torques were done in the 2- to 3-minute periods. Remaining time was spent stressing the wrist with a ball ratchet placed on several studs and maintaining an isotonic torque for 5 seconds. “A” cycle was to use the right hand with the ball ratchet, and finally 4 minutes in a supine position while flexing arms and legs sequentially to improve bubble detection by DT. Each limb was flexed 3 times along with wrist and ankle rotation. “B” cycle exercise included 4 minutes at mini-gym set to the same resistance

as “A” cycle and pulling twice in a 5-second period, 4 minutes at ergometer using same rate except using left hand and cranking counterclockwise, 4 minutes at torque station using same torque pattern except with left hand, 4 minutes rest after completing “B” cycle, and finally 4 minutes in a supine position while flexing arms and legs sequentially to improve bubble detection by DT. An additional 16 minutes of rest after 3 h of exercise was given to exercising subjects and DT due to altitude duration. Water was available only during the 6-hr chamber exposures. Subjects used these devices from a standing or seated (non-adiabatic) position and were allowed to walk during PB or altitude exposure. Test termination for DCS was after any performance was affected.

**Procedure 13 (Test 6):** A 2-hr O<sub>2</sub> PB at 14.7 psia prior to 24 h at 10.2 psia in the ETA, an altitude chamber configured to resemble the Shuttle crew compartment. After 24 h at 10.2 psia the subjects donned masks and ascended to 6.0 psia. A review of the protocol suggested a nominal 10-minute decompression from 14.7 psia to 10.2 psia and a nominal 10-min decompression from 10.2 psia to 6.0 psia. But a review of the logbook shows an average 8 min ascent from 14.7 psia to 10.2 psia and an average 7 min ascent from 10.2 psia to 6.0 psia. Subjects exercised 6 h while breathing a 60% O<sub>2</sub>-40% N<sub>2</sub> mixture. Gas composition at 10.2 psia was 28% O<sub>2</sub>-72% N<sub>2</sub>. Exercise stressed upper body. “A” cycle exercise included 4 minutes seated at mini-gym set to 16.7 kg of resistance and pulling once in 5 seconds with right arm then pulling once in 5 seconds with the left arm, 4 minutes standing at ergometer set to 5-N resistance and cranking 3 times in 5 seconds with right hand going clockwise. A 5-second rest was taken, then 3 cranks repeated, 4 minutes standing at torque station 107 cm above floor where ten 3/8-in. fixed studs were torqued to 400 cm-kg. Torque was held for 5 seconds in both directions. A total of 24 separate isotonic torques were done in the 2- to 3-minute periods. Remaining time was spent stressing the wrist with a ball ratchet placed on several studs and maintaining an isotonic torque for 5 seconds. “A” cycle was to use the right hand with the ball ratchet, and finally 4 minutes in a supine position while flexing arms and legs sequentially to improve bubble detection by DT. Each limb was flexed 3 times along with wrist and ankle rotation. “B” cycle exercise included 4 minutes at mini-gym set to the same resistance as “A” cycle and pulling twice in a 5-second period, 4 minutes at ergometer using same rate except using left hand and cranking counterclockwise, 4 minutes at torque station using same torque pattern except with left hand, 4 minutes rest after completing “B” cycle, and finally 4 minutes in a supine position while flexing arms and legs sequentially to improve bubble detection by DT. An additional 16 minutes of rest after 3 h of exercise was given to exercising subjects and DT due to altitude duration. Water was available only during the 6-hr chamber exposures. Subjects used these devices from a standing or seated (non-adiabatic) position and were allowed to walk during PB or altitude exposure. Test termination for DCS was after any performance was affected.

**Procedure 14 (Test 7a with high exercise):** Exposure to 6.5 psia in the PTC for 3 h after no PB. Decompression to 6.5 psia required 3.2 minutes (6,500 feet/minute). Row machine replaced the standard mini-gym and was used to achieve peak exercise of 2,000 Btu/hr for 15 minutes at about 1.5 h into the test. Prior to ascent, a brief ear and sinus check was done by depressurizing the chamber atmosphere to the equivalent of 6,000 feet altitude in approximately 1 minute (5,000 feet/minute). Subject breathed air during this check, which took approximately 5 minutes for 2 subjects and the DT to be evaluated, primarily during the repressurization back to site pressure. The medical technician exited the chamber and an ascent on air to 10 psia at 6,500 feet/minute



was begun 6 minutes from the start of initial ascent. About 2 minutes later, subject donned the O<sub>2</sub> mask at 10 psia and the chamber continued ascent to 6.5 psia at 6,500 feet/minute. For the first hr, “A” cycle exercise included 4 minutes standing at ergometer set to 5-N resistance and cranking 3 times in 5 seconds with right hand going clockwise. A 5-second rest was taken, and then 3 cranks repeated. There were 4 minutes standing at torque station above the floor where ten 3/8-in. fixed studs were torqued to 400 cm-kg with the right hand. Torque was held for 5 seconds in both directions. There were 4 minutes in a supine position while flexing arms and legs sequentially to improve bubble detection by DT. Each limb was flexed 3 times along with wrist and ankle rotation. There were 4 minutes in a semi-recumbent position on a row machine where upper and lower body was exercised. Cycle “B” exercise was the same as cycle “A” except the left hand was used with the torque and crank stations. At 64 minutes into the test, subject exercised for three 16-minute periods on the row machine, with a 4-minute Doppler monitoring at the end of each 16-minute cycle. The middle row exercise achieved about 2,000 Btu/hr while the previous and later 16-minute intervals achieved about 1,600 Btu/hr. For the last hr, the same cycle “A” and “B” exercises resumed. Subjects used these devices from a standing or seated (non-adiynamic) position and were allowed to walk prior to ascent or during altitude exposure. Test termination for DCS was after any performance was affected.

**Procedure 15 (Test 7b with low exercise):** Exposure to 6.5 psia in the PTC for 3 h after no PB. Decompression to 6.5 psia required 3.2 minutes (6,500 feet/minute). Row machine used in place of the standard mini-gym to achieve an average energy expenditure of 800 Btu/hr. Prior to ascent, a brief ear and sinus check was done by depressurizing the chamber atmosphere to the equivalent of 6,000 feet altitude in about 1 minute (5,000 feet/minute). Subject breathed air during this check, which took approximately 5 minutes for 2 subjects and the DT to be evaluated, primarily during the repressurization back to site pressure. The medical technician exited the chamber and an ascent on air to 10 psia at 6,500 feet/minute was begun 6 minutes from the start of initial ascent. About 2 minutes later, subject donned the O<sub>2</sub> mask at 10 psia and the chamber continued the ascent to 6.5 psia at 6,500 feet/minute. “A” cycle exercise included 4 minutes standing at ergometer set to 5-N resistance and cranking 3 times in 5 seconds with right hand going clockwise. A 5-second rest was taken, and then 3 cranks repeated. There were 4 minutes standing at torque station above the floor where ten 3/8-in. fixed studs were torqued to 400 cm-kg with the right hand. Torque was held for 5 seconds in both directions. There were 4 minutes in a supine position while flexing arms and legs sequentially to improve bubble detection by DT. Each limb was flexed 3 times along with wrist and ankle rotation. There were 4 minutes in a semi-recumbent position on a row machine where upper and lower body was exercised. Cycle “B” exercise was the same as cycle “A” except the left hand was used with the torque and crank stations. Subjects used these devices from a standing or seated (non-adiynamic) position and were allowed to walk prior to ascent or during altitude exposure. Test termination for DCS was after any performance was affected.

**Procedure 16 (Test 8a):** Exposure to 6.5 psia in the PTC for 3 h after no PB. Decompression to 6.5 psia required 3.2 minutes (6,500 feet/minute). Prior to ascent, a brief ear and sinus check was done by depressurizing the chamber atmosphere to the equivalent of 6,000 feet altitude in about 1 minute (5,000 feet/minute). Subject breathed air during this check, which took approximately 5 minutes for subjects and the DT to be evaluated, primarily during the repressurization back to site pressure. The medical technician exited the chamber and an ascent on air to 10 psia at 6,500

feet/minute was begun 6 minutes from the start of initial ascent. Approximately 2 minutes later, subject donned the O<sub>2</sub> mask at 10 psia and the chamber continued the ascent to 6.5 psia at 6,500 feet/minute. Exercise stressed the upper body. "A" cycle exercise included 4 minutes seated at mini-gym set to 16.7 kg of resistance and pulling once in 5 seconds with right arm then pulling once in 5 seconds with the left arm, 4 minutes standing at ergometer set to 5-N resistance and cranking 3 times in 5 seconds with right hand going clockwise. A 5-second rest was taken, then 3 cranks repeated, 4 minutes standing at torque station where ten 3/8-in. fixed studs were torqued to 400 cm-kg. Torque was held for 5 seconds in both directions. A total of 24 separate isotonic torques were done in the 2- to 3-minute periods. Remaining time was spent stressing the wrist with a ball ratchet placed on several studs and maintaining an isotonic torque for 5 seconds. "A" cycle was to use the right hand with the ball ratchet, and finally 4 minutes in a supine position while flexing arms and legs sequentially to improve bubble detection by DT. Each limb was flexed 3 times along with wrist and ankle rotation. "B" cycle exercise included 4 minutes at mini-gym set to the same resistance as "A" cycle and pulling twice in a 5-second period, 4 minutes at ergometer using same rate except using left hand and cranking counterclockwise, 4 minutes at torque station using same torque pattern except with left hand, 4 minutes rest after completing "B" cycle, and finally 4 minutes in a supine position while flexing arms and legs sequentially to improve bubble detection by DT. Subjects used these devices from a standing or seated (non-adiabatic) position and were allowed to walk during PB or altitude exposure. Test termination for DCS was after any performance was affected. A 1-hr posttest period breathing 100% O<sub>2</sub> for all subjects was observed, with longer periods as warranted at the direction of the attending MO.

**Procedure 17 (Test 8b):** Exposure to 6.5 psia in the PTC for 3 h after no PB. Decompression to 6.5 psia required 3.2 minutes (6,500 feet/minute). Prior to ascent, a brief ear and sinus check was done by depressurizing the chamber atmosphere to the equivalent of 6,000 feet altitude in approximately 1 minute (5,000 feet/minute). Subject breathed air during this check, which took about 5 minutes for subjects and the DT to be evaluated, primarily during the repressurization back to site pressure. The medical technician exited the chamber and an ascent on air to 10 psia at 6,500 feet/minute was begun 6 minutes from the start of the initial ascent. About 2 minutes later, subject donned the O<sub>2</sub> mask at 10 psia and the chamber continued the ascent to 6.5 psia at 6,500 feet/minute. Prior to exposure, subject performed 3 days of treadmill exercise at an anaerobic threshold for 30 minutes. A minimum of 16 h elapsed from the last treadmill exercise to the start of ascent. Exercise at 6.5 psia stressed the upper body. "A" cycle exercise included 4 minutes seated at mini-gym set to 16.7 kg of resistance and pulling once in 5 seconds with right arm then pulling once in 5 seconds with the left arm, 4 minutes standing at ergometer set to 5-N resistance and cranking 3 times in 5 seconds with right hand going clockwise. A 5-second rest was taken, then 3 cranks repeated, 4 minutes standing at torque station where ten 3/8-in. fixed studs were torqued to 400 cm-kg. Torque was held for 5 seconds in both directions. A total of 24 separate isotonic torques were done in the 2- to 3-minute periods. Remaining time was spent stressing the wrist with a ball ratchet placed on several studs and maintaining an isotonic torque for 5 seconds. "A" cycle was to use the right hand with the ball ratchet, and finally 4 minutes in a supine position while flexing arms and legs sequentially to improve bubble detection by DT. Each limb was flexed 3 times along with wrist and ankle rotation. "B" cycle exercise included 4 minutes at mini-gym set to the same resistance as "A" cycle and pulling twice in a 5-second period, 4 minutes at ergometer using same rate except using left hand and cranking counterclockwise, 4

minutes at torque station using same torque pattern except with left hand, 4 minutes rest after completing “B” cycle, and finally 4 minutes in a supine position while flexing arms and legs sequentially to improve bubble detection by DT. Subjects used these devices from a standing or seated (non-adyamic) position and were allowed to walk during PB or altitude exposure. Test termination for DCS was after any performance was affected. A 1-hr posttest period breathing 100% O<sub>2</sub> for all subjects was observed, with longer periods as warranted at the direction of the attending MO.

**Procedure 18 (Test 9a):** Exposure to 6.5 psia in the PTC for 3 h after no PB. Decompression to 6.5 psia required 3.2 minutes (6,500 feet/minute). Prior to ascent, a brief ear and sinus check was done by depressurizing the chamber atmosphere to the equivalent of 6,000 feet altitude in about 1 minute (5,000 feet/minute). Subject breathed air during this check, which took approximately 5 minutes for subjects and the DT to be evaluated, primarily during the repressurization back to site pressure. The medical technician exited the chamber and an ascent on air to 10 psia at 6,500 feet/minute was begun 6 minutes from the start of initial ascent. About 2 minutes later, subject donned the O<sub>2</sub> mask at 10 psia and the chamber continued the ascent to 6.5 psia at 6,500 feet/minute. Exercise stressed the upper body. “A” cycle exercise included 4 minutes seated at mini-gym set to 16.7 kg of resistance and pulling once in 5 seconds with right arm then pulling once in 5 seconds with the left arm, 4 minutes standing at ergometer set to 5-N resistance and cranking 3 times in 5 seconds with right hand going clockwise. A 5-second rest was taken, then 3 cranks repeated, 4 minutes standing at torque station where ten 3/8-in. fixed studs were torqued to 400 cm-kg. Torque was held for 5 seconds in both directions. A total of 24 separate isotonic torques were done in the 2- to 3-minute periods. The remaining time was spent stressing the wrist with a ball ratchet placed on several studs and maintaining an isotonic torque for 5 seconds. “A” cycle was to use the right hand with the ball ratchet, and finally 4 minutes in a supine position while flexing arms and legs sequentially to improve bubble detection by DT. Each limb was flexed 3 times along with wrist and ankle rotation. “B” cycle exercise included 4 minutes at mini-gym set to the same resistance as “A” cycle and pulling twice in a 5-second period, 4 minutes at ergometer using same rate except using left hand and cranking counterclockwise, 4 minutes at torque station using same torque pattern except with left hand, 4 minutes rest after completing “B” cycle, and finally 4 minutes in a supine position while flexing arms and legs sequentially to improve bubble detection by DT. Subjects used these devices from a standing or seated (non-adyamic) position and were allowed to walk prior to and during altitude exposure. Test termination for DCS was after any performance was affected.

**Procedure 19 (Test 9b):** Three days prior to ascent, subject was maintained in strict bed rest in a 6-degree head-down tilt. Exposure to 6.5 psia in the PTC for 3 h after no PB. Decompression to 6.5 psia required 3.2 minutes (6,500 feet/minute). Prior to ascent, a brief ear and sinus check was done by depressurizing the chamber atmosphere to the equivalent of 6,000 feet altitude in about 1 minute (5,000 feet/minute). Subject breathed air during this check, which took approximately 5 minutes for subjects and the DT to be evaluated, primarily during the repressurization back to site pressure. The medical technician exited the chamber and an ascent on air to 10 psia at 6,500 feet/minute was begun 6 minutes from the start of initial ascent. About 2 minutes later, subject donned the O<sub>2</sub> mask at 10 psia and the chamber continued the ascent to 6.5 psia at 6,500 feet/minute. Exercise stressed upper body and was performed while still in a 6-degree head-down tilt. “A” cycle exercise included 4 minutes at mini-gym set to 16.7 kg of resistance and pulling

once in 5 seconds with right arm then pulling once in 5 seconds with the left arm, 4 minutes at ergometer set to 5-N resistance and cranking 3 times in 5 seconds with right hand going clockwise. A 5-second rest was taken, then 3 cranks repeated, 4 minutes at torque station where ten 3/8-in. fixed studs were torqued to 400 cm-kg. Torque was held for 5 seconds in both directions. A total of 24 separate isotonic torques were done in the 2- to 3-minute periods. Remaining time was spent stressing the wrist with a ball ratchet placed on several studs and maintaining an isotonic torque for 5 seconds. "A" cycle was to use the right hand with the ball ratchet, and finally 4 minutes in a 6-degree head-down position while flexing arms and legs sequentially to improve bubble detection by DT. Each limb was flexed 3 times along with wrist and ankle rotation. "B" cycle exercise included 4 minutes at mini-gym set to the same resistance as "A" cycle and pulling twice in a 5-second period, 4 minutes at ergometer using same rate except using left hand and cranking counterclockwise, 4 minutes at torque station using same torque pattern except with left hand, 4 minutes rest after completing "B" cycle, and finally 4 minutes in a supine position while flexing arms and legs sequentially to improve bubble detection by DT. Subjects used these devices from a recumbent (adynamic) position and were not allowed to walk prior to or during altitude exposure. Test termination for DCS was after any performance was affected.

**Procedure 20 (Test 9c):** A 4-hr O<sub>2</sub> PB at 14.7 psia prior to a 3-hr exposure to 4.3 psia in the PTC. Prior to ascent, a brief ear and sinus check was done by depressurizing the chamber atmosphere to the equivalent of 6,000 feet altitude in about 1 minute (5,000 feet/minute). Subject breathed O<sub>2</sub> during this check, which took approximately 5 minutes for subjects and the DT to be evaluated, primarily during the repressurization back to site pressure. The medical technician exited the chamber before the ascent to 4.3 psia at 5,000 feet/minute. Ascent was 6 minutes to 4.3 psia. Exercise stressed the upper body. "A" cycle exercise included 4 minutes seated at mini-gym set to 16.7 kg of resistance and pulling once in 5 seconds with right arm then pulling once in 5 seconds with the left arm, 4 minutes standing at ergometer set to 5-N resistance and cranking 3 times in 5 seconds with right hand going clockwise. A 5-second rest was taken, then 3 cranks repeated, 4 minutes standing at torque station where ten 3/8-in. fixed studs were torqued to 400 cm-kg. Torque was held for 5 seconds in both directions. A total of 24 separate isotonic torques were done in the 2- to 3-minute periods. Remaining time was spent stressing the wrist with a ball ratchet placed on several studs and maintaining an isotonic torque for 5 seconds. "A" cycle was to use the right hand with the ball ratchet, and finally 4 minutes in a supine position while flexing arms and legs sequentially to improve bubble detection by DT. Each limb was flexed 3 times along with wrist and ankle rotation. "B" cycle exercise included 4 minutes at mini-gym set to the same resistance as "A" cycle and pulling twice in a 5-second period, 4 minutes at ergometer using the same rate except using left hand and cranking counterclockwise, 4 minutes at torque station using the same torque pattern except with left hand, 4 minutes rest after completing "B" cycle, and finally 4 minutes in a supine position while flexing arms and legs sequentially to improve bubble detection by DT. Subjects used these devices from a standing or seated (non-adynamic) position and were allowed to walk prior to and during altitude exposure. Test termination for DCS was after any performance was affected.

**Procedure 20a (Test 9d):** Subjects were adynamic for 6 h by sitting in a chair prior to the start of ascent. During this period of adynamia a 4-hr O<sub>2</sub> PB at 14.7 psia was done prior to a 3-hr exposure to 4.3 psia in the PTC. Prior to ascent, a brief ear and sinus check was done by depressurizing the chamber atmosphere to the equivalent of 6,000 feet altitude in about 1 minute

(5,000 feet/minute). Subject breathed O<sub>2</sub> during this check, which took approximately 5 minutes for subjects and the DT to be evaluated, primarily during the repressurization back to site pressure. The medical technician exited the chamber before the ascent to 4.3 psia at 5,000 feet/minute. Ascent was 6 minutes to 4.3 psia. Exercise stressed the upper body. "A" cycle exercise included 4 minutes seated at mini-gym set to 16.7 kg of resistance and pulling once in 5 seconds with right arm then pulling once in 5 seconds with the left arm, 4 minutes standing at ergometer set to 5-N resistance and cranking 3 times in 5 seconds with right hand going clockwise. A 5-second rest was taken, then 3 cranks repeated, 4 minutes standing at torque station where ten 3/8-in. fixed studs were torqued to 400 cm-kg. Torque was held for 5 seconds in both directions. A total of 24 separate isotonic torques were done in the 2- to 3-minute periods. Remaining time was spent stressing the wrist with a ball ratchet placed on several studs and maintaining an isotonic torque for 5 seconds. "A" cycle was to use the right hand with the ball ratchet, and finally 4 minutes in a supine position while flexing arms and legs sequentially to improve bubble detection by DT. Each limb was flexed 3 times along with wrist and ankle rotation. "B" cycle exercise included 4 minutes at mini-gym set to the same resistance as "A" cycle and pulling twice in a 5-second period, 4 minutes at ergometer using the same rate except using left hand and cranking counterclockwise, 4 minutes at torque station using the same torque pattern except with left hand, 4 minutes rest after completing "B" cycle, and finally 4 minutes in a supine position while flexing arms and legs sequentially to improve bubble detection by DT. Subjects used these devices from a recumbent (adynamic) position and were not allowed to walk prior to or during altitude exposure. Test termination for DCS was after any performance was affected.

**Procedure 20b (Test 9e):** Subjects were adynamic for 6 h by sitting in a chair prior to the start of ascent. During this period of adynamia a 4-hr O<sub>2</sub> PB at 14.7 psia was done prior to a 3-hr exposure to 4.3 psia in the PTC. Starting 3.5 h before ascent very light upper and lower body exercise was done during the PB. The goal was to achieve about 140 kcal/hr, but measured metabolic rate in the laboratory was closer to  $188 \pm 15$  kcal/hr. The exercise consisted of lower body bicycle ergometry from the chair at 50 revolutions/minute at 25 watts for 10 seconds followed by 5 seconds of upper body exercise by lifting two three-pound weights, one for each arm. This sequence was continuous for the last 3.5 h of a 4-hr PB. Prior to ascent, a brief ear and sinus check was done by depressurizing the chamber atmosphere to the equivalent of 6,000 feet altitude in about 1 minute (5,000 feet/minute). Subject breathed O<sub>2</sub> during this check, which took approximately 5 minutes for subjects and the DT to be evaluated, primarily during the repressurization back to site pressure. The medical technician exited the chamber before the ascent to 4.3 psia at 5,000 feet/minute. Ascent was 6 minutes to 4.3 psia. Exercise stressed the upper body. "A" cycle exercise included 4 minutes seated at mini-gym set to 16.7 kg of resistance and pulling once in 5 seconds with right arm then pulling once in 5 seconds with the left arm, 4 minutes standing at ergometer set to 5-N resistance and cranking 3 times in 5 seconds with right hand going clockwise. A 5-second rest was taken, then 3 cranks repeated, 4 minutes standing at torque station where ten 3/8-in. fixed studs were torqued to 400 cm-kg. Torque was held for 5 seconds in both directions. A total of 24 separate isotonic torques were done in the 2- to 3-minute periods. Remaining time was spent stressing the wrist with a ball ratchet placed on several studs and maintaining an isotonic torque for 5 seconds. "A" cycle was to use the right hand with the ball ratchet, and finally 4 minutes in a supine position while flexing arms and legs sequentially to improve bubble detection by DT. Each limb was flexed 3 times along with wrist

and ankle rotation. “B” cycle exercise included 4 minutes at mini-gym set to the same resistance as “A” cycle and pulling twice in a 5-second period, 4 minutes at ergometer using the same rate except using left hand and cranking counterclockwise, 4 minutes at torque station using the same torque pattern except with left hand, 4 minutes rest after completing “B” cycle, and finally 4 minutes in a supine position while flexing arms and legs sequentially to improve bubble detection by DT. Subjects used these devices from a recumbent (adynamic) position and were not allowed to walk prior to or during altitude exposure. Test termination for DCS was after any performance was affected.

**Procedure 21 (Test 10):** Subjects exercised while breathing air at a simulated depth of 20 feet in a hyperbaric chamber. A 0.33-minute compression (1 fsw/sec) to 1.59 ATA in the Hyperbaric Treatment Chamber (20 feet fresh water depth), 400-minute exposed to air while performing three 4-minute exercises with a 4-minute period of rest. The exercise consisted of right arm ergometry from a standing position at a rate of 10 rev clockwise per 5 seconds against a weight of 6 lbs with a rest period of 5 seconds before starting left arm ergometry with a counterclockwise rotation, lifting a 3-lb weight in each hand while performing a step test, and 4 minutes standing at torque station where ten 3/8-in. fixed studs were torqued to 400 cm·kg. Torque was held for 5 seconds in both directions. A total of 24 separate isotonic torques were done in the 2- to 3-minute periods. Remaining time was spent stressing the wrist with a ball ratchet placed on several studs and maintaining an isotonic torque for 5 seconds. “A” cycle was to use the right hand and “B” cycle was to use the left hand. Cycles are repeated for 400 minutes with a 4-minute rest every 30 minutes and an 8-minute rest every hr. Ascent to site pressure was made in 0.33 minutes; 14 h elapsed before a 2-minute ascent to 10.1 psia (10,000 feet altitude) in the PTC. Subject breathed air at 10,000 feet and did no exercise during the 3-hr exposure. Doppler monitoring performed for 4 minutes after 16 minutes of exercise for the duration of exposure. Subjects used the exercise devices at 1.59 ATA from a standing (non-adynamic) position and were allowed to walk during the surface interval and altitude exposure. Test termination for DCS was after any performance was affected.

**Procedure 22 (Test 11a):** A 3-hr O<sub>2</sub> PB at 14.7 psia prior to a 4-hr exposure to 4.3 psia in the PTC. Prior to ascent, a brief ear and sinus check was done by depressurizing the chamber atmosphere to the equivalent of 6,000 feet altitude in about 1 minute (5,000 feet/minute). Subject breathed O<sub>2</sub> during this check, which took approximately 5 minutes for subjects and the DT to be evaluated, primarily during repressurization back to site pressure. The medical technician exited the chamber before the ascent to 4.3 psia at 5,000 feet/minute. Ascent was 6 minutes to 4.3 psia. The average PB time to the start of exercise at 4.3 psia was  $195 \pm 3$  minutes, with a range from 190 to 204 minutes. Exercise stressed the upper body. “A” cycle exercise included 4 minutes seated at mini-gym set to 16.7 kg of resistance and pulling once in 5 seconds with right arm then pulling once in 5 seconds with the left arm, 4 minutes seated at ergometer set to 5-N resistance and cranking 3 times in 5 seconds with right hand going clockwise. A 5-second rest was taken, then 3 cranks repeated, 4 minutes seated at torque station where ten 3/8-in. fixed studs were torqued to 400 cm·kg. Torque was held for 5 seconds in both directions. A total of 24 separate isotonic torques were done in the 2- to 3-minute periods. Remaining time was spent stressing the wrist with a ball ratchet placed on several studs and maintaining an isotonic torque for 5 seconds. “A” cycle was to use the right hand with the ball ratchet, and finally 4 minutes in a supine position while flexing arms and legs sequentially to improve bubble detection by DT. Each limb

was flexed 3 times along with wrist and ankle rotation. “B” cycle exercise included 4 minutes at mini-gym set to the same resistance as “A” cycle and pulling twice in a 5-second period, 4 minutes at ergometer using same rate except using left hand and cranking counterclockwise, 4 minutes at torque station using same torque pattern except with left hand, 4 minutes rest after completing “B” cycle, and finally 4 minutes in a seated position while flexing arms and legs sequentially to improve bubble detection by DT. Subjects used these devices from a seated (adynamic) position and were not allowed to walk during PB or altitude exposure. Test termination for DCS was at first indication of DCS.

**Procedure 22a (11b):** The intent of this brief study was to compare the quality of blood flow and bubble detection with a prototype in-suit Doppler ultrasound bubble detector with our standard medical-grade Doppler ultrasound unit (Neuroguard). The goal was to create decompression stress to elicit VGE, but not to have symptoms of DCS. There was no O<sub>2</sub> PB at 14.7 psia prior to a 2-hr exposure to 6.5 psia in the PTC. Prior to ascent, a brief ear and sinus check was done by depressurizing the chamber atmosphere to the equivalent of 6,000 feet altitude in about 1 minute (5,000 feet/minute). Subject breathed O<sub>2</sub> during this check, which took approximately 5 minutes for subjects and the DT to be evaluated, primarily during the repressurization back to site pressure. The medical technician exited the chamber before the ascent to 6.5 psia at 5,000 feet/minute. Ascent was 4.2 minutes to 6.5 psia. Exercise stressed the lower body. The subjects walked within the chamber to encourage VGE from the lower body. They walked for 2 minutes, and sat on a bench for 6 minutes, then started the cycle again. Every 12 minutes they would be monitored for 2 minutes with the Neuroguard Doppler ultrasound from the precordial position, then 2 minutes of monitoring with the prototype in-suit Doppler bubble detector with the probe held in place over the pulmonary artery by the DT. During this monitoring period the subjects flexed arms and legs sequentially to improve bubble detection by the DT. Test termination for DCS was after any performance was affected.

**Procedure 23 (Phase I PRP):** PB exercise was 10 minutes of dual-cycle arm and leg ergometry initiated at the start of PB, and done at 75% of peak O<sub>2</sub> consumption for the last 7 minutes. The subject first performed a peak O<sub>2</sub> consumption test (VO<sub>2</sub> peak test) using leg ergometry several days before the experiment, and a linear regression of O<sub>2</sub> consumption vs. watts (workload) was created. An exercise prescription based on watts was produced that distributes the appropriate workload between the upper body (12%) and the lower body (88%). One the day of the test the first 3 minutes of the dual-cycle arm and leg ergometry was warm-up, at about 75 rpm using a prescription that increased work from 37.5%, to 50.0% and then to 62.5% of the VO<sub>2</sub> peak. The ergometry was completed after 7 min at 75% of VO<sub>2</sub> peak. No additional exercise was allowed for the balance of the 150-minute O<sub>2</sub> PB. After 50 minutes of 100% O<sub>2</sub> PB at site pressure, subject ascended to 9.6 psia in 20 minutes followed by a 10-minute descent to 10.2 psia, still breathing 100% O<sub>2</sub>. The gas supply was switched in the mask, and subject breathed 73.5% N<sub>2</sub> and 26.5% O<sub>2</sub> for 30 minutes while at 10.2 psia. A 100% O<sub>2</sub> PB was reestablished and, after 5 minutes, a descent to site pressure was performed. Subject remained on 100% O<sub>2</sub> for 35 minutes at site pressure and during the 30-minute ascent to 4.3 psia. Subject breathed 100% O<sub>2</sub> for the duration of the 4-hr test. Five exercise devices simulated intense hand and upper body activity plus postural contractions in the lower body that occur during EVA. Two bungee cord devices simulated the resistance to move a flexible spacesuit from an otherwise neutral position. Subjects pulled bungee cord with left and right arm across the chest, and flexed

the upper body forward against the bungee cord connected to the back of a harness. Three other devices simulated assembly tasks done while in a spacesuit. Subjects torqued fixed studs to 25 ft-lb with the right and left arm, contracted the right and left hand with 5-lb of force using a hand exercise device, and pulled against a plate at their feet with leg muscles contracted to resist the pull to a force in lbs normalized to their body weight. Subjects used these devices from a recumbent (adynamic) position and were not allowed to walk during PB or altitude exposure. Each activity was 4 minutes in duration and performed at a 5- or 10-second cadence with brief periods of rest during some activities. There were also 4-minute periods with no physical activity, and 4 minutes in a supine position while flexing arms and legs sequentially to improve bubble detection by DT. Each limb was flexed 3 times along with wrist and ankle rotation. Test termination for DCS was at first indication of DCS.

**Procedure 24 (Phase II PRP):** PB exercise was 10 minutes of dual-cycle arm and leg ergometry initiated at the start of PB, and done at 75% of peak O<sub>2</sub> consumption for the last 7 minutes. The subject first performed a peak O<sub>2</sub> consumption test (VO<sub>2</sub> peak test) using leg ergometry several days before the experiment, and a linear regression of O<sub>2</sub> consumption vs. watts (workload) was created. An exercise prescription based on watts was produced that distributes the appropriate workload between the upper body (12%) and the lower body (88%). One the day of the test the first 3 minutes of the dual-cycle arm and leg ergometry was warm-up, at about 75 rpm using a prescription that increased work from 37.5%, to 50.0% and then to 62.5% of the VO<sub>2</sub> peak. The ergometry was completed after 7 min at 75% of VO<sub>2</sub> peak plus 24 minutes of additional intermittent light arm and leg exercise starting 55 minutes into the PB and ending 95 minutes after the start of PB. Here, heavy short-duration ergometry exercise was combined with light intermittent short-duration exercise during the latter part of the PB. After 50 minutes of 100% O<sub>2</sub> PB at site pressure, subject ascended to 9.6 psia in 20 minutes followed by a 10-minute descent to 10.2 psia, still breathing 100% O<sub>2</sub>. After the gas supply was switched in the mask, the subject breathed 73.5% N<sub>2</sub> and 26.5% O<sub>2</sub> for 30 minutes while at 10.2 psia. A 100% O<sub>2</sub> PB was reestablished and, after 5 minutes, a descent to site pressure was performed. Subject remained on 100% O<sub>2</sub> for 35 minutes at site pressure and during the 30-minute ascent to 4.3 psia. Subject breathed 100% O<sub>2</sub> for the duration of the 4-hr test. Five exercise devices simulated intense hand and upper body activity plus postural contractions in the lower body that occur during EVA. Two bungee cord devices simulated the resistance to move a flexible spacesuit from an otherwise neutral position. Subjects pulled bungee cord with left and right arm across the chest, and flexed the upper body forward against the bungee cord connected to the back of a harness. Three other devices simulated assembly tasks done while in a spacesuit. Subjects torqued fixed studs to 25 ft-lb with the right and left arm, contracted the right and left hand with 5-lb of force using a hand exercise device, and pulled against a plate at their feet with leg muscles contracted to resist the pull to a force in lbs normalized to their body weight. Subjects used these devices from a recumbent (adynamic) position and were not allowed to walk during PB or altitude exposure. Each activity was 4 minutes in duration and performed at a 5- or 10-second cadence with brief periods of rest during some activities. There were also 4-minute periods with no physical activity, and 4 minutes in a supine position while flexing arms and legs sequentially to improve bubble detection by DT. Each limb was flexed 3 times along with wrist and ankle rotation. Test termination for DCS was at first indication of DCS.



**Procedure 25 (Phase III PRP):** PB exercise was 24 minutes of intermittent light arm and leg exercise starting 55 minutes into the PB and ending 95 minutes after the start of PB. After 50 minutes of 100% O<sub>2</sub> PB at site pressure, subject ascended to 9.6 psia in 20 minutes followed by a 10-minute descent to 10.2 psia, still breathing 100% O<sub>2</sub>. The gas supply was switched in the mask, and subject breathed 73.5% N<sub>2</sub> and 26.5% O<sub>2</sub> for 30 minutes while at 10.2 psia. A 100% O<sub>2</sub> PB was reestablished and, after 5 minutes, a descent to site pressure was performed. Subject remained on 100% O<sub>2</sub> for 35 minutes at site pressure and during the 30-minute ascent to 4.3 psia. Subject breathed 100% O<sub>2</sub> for the duration of the 4-hr test. Five exercise devices simulated intense hand and upper body activity plus postural contractions in the lower body that occur during EVA. Two bungee cord devices simulated the resistance to move a flexible spacesuit from an otherwise neutral position. Subjects pulled bungee cord with left and right arm across the chest, and flexed the upper body forward against the bungee cord connected to the back of a harness. Three other devices simulated assembly tasks done while in a spacesuit. Subjects torqued fixed studs to 25 ft-lb with the right and left arm, contracted the right and left hand with 5-lb of force using a hand exercise device, and pulled against a plate at their feet with leg muscles contracted to resist the pull to a force in lbs normalized to their body weight. Subjects used these devices from a recumbent (adynamic) position and were not allowed to walk during PB or altitude exposure. Each activity was 4 minutes in duration and performed at a 5- or 10-second cadence with brief periods of rest during some activities. There were also 4-minute periods with no physical activity, and 4 minutes in a supine position while flexing arms and legs sequentially to improve bubble detection by DT. Each limb was flexed 3 times along with wrist and ankle rotation. Test termination for DCS was at first indication of DCS.

**Procedure 26 (Phase IV PRP):** PB exercise was 56 minutes of intermittent light long-duration arm and leg exercise that started 4 minutes into the PB and ended 95 minutes from the start of the PB. After 50 minutes of 100% O<sub>2</sub> PB at site pressure, subject ascended to 9.6 psia in 20 minutes followed by a 10-minute descent to 10.2 psia, still breathing 100% O<sub>2</sub>. The gas supply was switched in the mask, and subject breathed 73.5% N<sub>2</sub> and 26.5% O<sub>2</sub> for 30 minutes while at 10.2 psia. A 100% O<sub>2</sub> PB was reestablished and, after 5 minutes, a descent to site pressure was performed. Subject remained on 100% O<sub>2</sub> for 35 minutes at site pressure and during a 30-minute ascent to 4.3 psia. Subject breathed 100% O<sub>2</sub> for the duration of the 4-hr test. Five exercise devices simulated intense hand and upper body activity plus postural contractions in the lower body that occur during EVA. Two bungee cord devices simulated the resistance to move a flexible spacesuit from an otherwise neutral position. Subjects pulled bungee cord with left and right arm across the chest, and flexed the upper body forward against the bungee cord connected to the back of a harness. Three other devices simulated assembly tasks done while in a spacesuit. Subjects torqued fixed studs to 25 ft-lb with the right and left arm, contracted the right and left hand with 5-lb of force using a hand exercise device, and pulled against a plate at their feet with leg muscles contracted to resist the pull to a force in lbs normalized to their body weight. Subjects used these devices from a recumbent (adynamic) position and were not allowed to walk during PB or altitude exposure. Each activity was 4 minutes in duration and performed at a 5- or 10-second cadence with brief periods of rest during some activities. There were also 4-minute periods with no physical activity, and 4 minutes in a supine position while flexing arms and legs sequentially to improve bubble detection by DT. Each limb was flexed 3 times along with wrist and ankle rotation. Test termination for DCS was at first indication of DCS.



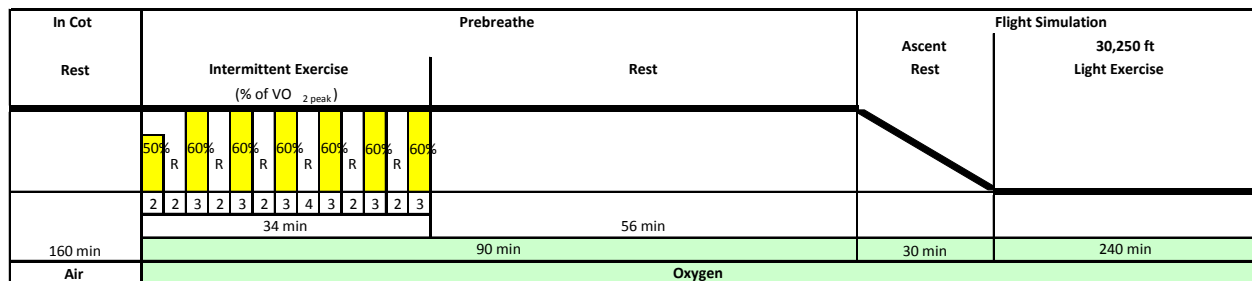

Fig. 2. Timeline of PRP Phase V-2.

The subject first performed a peak O<sub>2</sub> consumption test (VO<sub>2</sub> peak test) using leg ergometry several days before the experiment, and a linear regression of O<sub>2</sub> consumption vs. watts (workload) was created. An exercise prescription based on watts was produced that distributes the appropriate workload between the upper body (12%) and the lower body (88%), with ergometry at about 75 rpm. After 90 minutes of 100% O<sub>2</sub> PB at site pressure, the subject ascended to 4.3 psia in 30 minutes, still breathing 100% O<sub>2</sub>. Subject breathed 100% O<sub>2</sub> for the duration of the 4-hr test. Five exercise devices simulated intense hand and upper body activity plus postural contractions in the lower body that occur during EVA. Two bungee cord devices simulated the resistance to move a flexible spacesuit from an otherwise neutral position. Subjects pulled bungee cord with left and right arm across the chest, and flexed the upper body forward against the bungee cord connected to the back of a harness. Three other devices simulated assembly tasks done while in a spacesuit. Subjects torqued fixed studs to 25 ft-lb with the right and left arm, contracted the right and left hand with 5-lb of force using a hand exercise device, and pulled against a plate at their feet with leg muscles contracted to resist the pull to a force in lbs normalized to their body weight. Subjects used these devices from a recumbent (adynamic) position and were not allowed to walk during PB or altitude exposure. Each activity was 4 minutes in duration and performed at a 5- or 10-second cadence with brief periods of rest during some activities. There were also 4-minute periods with no physical activity, and 4 minutes in a supine position while flexing arms and legs sequentially to improve bubble detection by DT. Each limb was flexed 3 times along with wrist and ankle rotation. Test termination for DCS was at first indication of DCS.

**Procedure 29 (Phase V-3 PRP):** PB exercise combined moderate intensity intermittent exercise and low intensity exercise periods. The PB began with 20 minutes of intermittent dual-cycle arm and leg ergometry conducted in the first 36 minutes of the PB (an initial two minute rest period was followed by a two minute warm up exercise targeting 50%, the subjects then repeated a pattern of 3 minutes exercise at 60% VO<sub>2</sub> followed by two minutes rest). Subjects remained at rest for 14 minutes following the intermittent exercise. Forty minutes of light exercise in the suit exercise simulator was then conducted, and the remaining 30 minutes of the PB period was spent at rest. Details appear in Fig. 3.

In Cot	Prebreathe					Flight Simulation								
	Intermittent Exercise (% of VO <sub>2</sub> peak)					Rest	Light Exercise	Rest	Ascent Rest	30,250 ft Light Exercise				
Rest	R	50%R	60%R	60%R	60%R	60%R	60%R	60%R	60%R	Transfer				
	2	2	2	3	2	3	3	4	3	2	3	2	3	
	36 min					14	40 min (24 min in cot exercise)			30 min				
						84 min								
130 min						120 min					30 min	240 min		
Air	Oxygen													

**Fig. 3. Timeline of PRP Phase V-3.**

The subject first performed a peak O<sub>2</sub> consumption test (VO<sub>2</sub> peak test) using leg ergometry several days before the experiment, and a linear regression of O<sub>2</sub> consumption vs. watts (workload) was created. An exercise prescription based on watts was produced that distributes the appropriate workload between the upper body (12%) and the lower body (88%), with ergometry at about 75 rpm. After 120 minutes of 100% O<sub>2</sub> PB at site pressure, the subject ascended to 4.3 psia in 30 minutes, still breathing 100% O<sub>2</sub>. Subject breathed 100% O<sub>2</sub> for the duration of the 4-hr test. Five exercise devices simulated intense hand and upper body activity plus postural contractions in the lower body that occur during EVA. Two bungee cord devices simulated the resistance to move a flexible spacesuit from an otherwise neutral position. Subjects pulled bungee cord with left and right arm across the chest, and flexed the upper body forward against the bungee cord connected to the back of a harness. Three other devices simulated assembly tasks done while in a spacesuit. Subjects torqued fixed studs to 25 ft-lb with the right and left arm, contracted the right and left hand with 5-lb of force using a hand exercise device, and pulled against a plate at their feet with leg muscles contracted to resist the pull to a force in lbs normalized to their body weight. Subjects used these devices from a recumbent (adynamic) position and were not allowed to walk during PB or altitude exposure. Each activity was 4 minutes in duration and performed at a 5- or 10-second cadence with brief periods of rest during some activities. There were also 4-minute periods with no physical activity, and 4 minutes in a supine position while flexing arms and legs sequentially to improve bubble detection by DT. Each limb was flexed 3 times along with wrist and ankle rotation. Test termination for DCS was at first indication of DCS.

**Procedure 30 (Phase V-4 PRP):** PB exercise moved away from the effort to employ high intensity and short duration intermittent dual-cycle ergometry exercise. Instead, it incorporated 150 minutes of intermittent light activity (5.8 ml/kg-min) in a 160 minute O<sub>2</sub> PB conducted at site pressure. Details appear in Fig. 4.

In Cot	Prebreathe		Flight Simulation	
	Light Exercise (mean of 5.8 mL*kg <sup>-1</sup> *min <sup>-1</sup> )	Rest	Ascent Rest	30,250 ft Light Exercise
Rest	Intermittent in-cot exercise			
	150 min	10 min		
130 min	160 min		30 min	240 min
Air	Oxygen			

**Fig. 4. Timeline of PRP Phase V-4.**

After 160 minutes of 100% O<sub>2</sub> PB at site pressure, the subject ascended to 4.3 psia in 30 minutes, still breathing 100% O<sub>2</sub>. Subject breathed 100% O<sub>2</sub> for the duration of the 4-hr test. Five exercise devices simulated intense hand and upper body activity plus postural contractions in the lower body that occur during EVA. Two bungee cord devices simulated the resistance to move a flexible spacesuit from an otherwise neutral position. Subjects pulled bungee cord with left and right arm across the chest, and flexed the upper body forward against the bungee cord connected to the back of a harness. Three other devices simulated assembly tasks done while in a spacesuit. Subjects torqued fixed studs to 25 ft-lb with the right and left arm, contracted the right and left hand with 5-lb of force using a hand exercise device, and pulled against a plate at their feet with leg muscles contracted to resist the pull to a force in lbs normalized to their body weight. Subjects used these devices from a recumbent (adynamic) position and were not allowed to walk during PB or altitude exposure. Each activity was 4 minutes in duration and performed at a 5- or 10-second cadence with brief periods of rest during some activities. There were also 4-minute periods with no physical activity, and 4 minutes in a supine position while flexing arms and legs sequentially to improve bubble detection by DT. Each limb was flexed 3 times along with wrist and ankle rotation. Test termination for DCS was at first indication of DCS.

**Procedure 31 (Phase V-5 PRP):** PB exercise was low intensity for longer duration spaced over 190 minutes, which included 30 minutes for suit donning at 10.2 psia while breathing 26.5% O<sub>2</sub>. There was 90 minutes of upper body light exercise (mean 5.8 mL·kg<sup>-1</sup>·min<sup>-1</sup>) using the suit exercise simulator, followed by 50 minutes of light leg ergometer exercise at approximately 6.8 mL·kg<sup>-1</sup>·min<sup>-1</sup> using a leg ergometer mounted on the suit exercise simulator, followed by 50 minutes of rest before depress to 4.3 psia. Details appear in Fig. 5.

In Cot	Prebreathe					Flight Simulation	
	Rest	Light Exercise (suit simulator) (5.8 mL·kg <sup>-1</sup> ·min <sup>-1</sup> )		Leg Ergometer Exercise (6.8 mL·kg <sup>-1</sup> ·min <sup>-1</sup> )	Rest	Ascent Rest	30,250 ft Light Exercise
		Depress to 10.2 psi	Repr	in-cot			
	40 min	20 min	5	45 min			
	60 min		30 min	50 min	50 min		
130 min	190 min					30 min	240 min
Air	Oxygen		0.265 Oxygen	Oxygen			

**Fig. 5. Timeline of Proposed PRP Phase V-5.**

After the 190 minute staged exercise PB protocol, the subject ascended to 4.3 psia in 30 minutes, still breathing 100% O<sub>2</sub>. Subject breathed 100% O<sub>2</sub> for the duration of the 4-hr test. Five exercise devices simulated intense hand and upper body activity plus postural contractions in the lower body that occur during EVA. Two bungee cord devices simulated the resistance to move a flexible spacesuit from an otherwise neutral position. Subjects pulled bungee cord with left and right arm across the chest, and flexed the upper body forward against the bungee cord connected to the back of a harness. Three other devices simulated assembly tasks done while in a spacesuit. Subjects torqued fixed studs to 25 ft-lb with the right and left arm, contracted the right and left hand with 5-lb of force using a hand exercise device, and pulled against a plate at their feet with leg muscles contracted to resist the pull to a force in lbs normalized to their body weight. Subjects used these devices from a recumbent (adynamic) position and were not allowed to walk during PB or altitude exposure. Each activity was 4 minutes in duration and performed at a 5- or 10-second cadence with brief periods of rest during some activities. There were also 4-minute

periods with no physical activity, and 4 minutes in a supine position while flexing arms and legs sequentially to improve bubble detection by DT. Each limb was flexed 3 times along with wrist and ankle rotation. Test termination for DCS was at first indication of DCS.

## Appendix VI: Summary of Protocols from 1982 to 2009

Test	P2 (psia)	duration (hr)	sample m f	mean age	DCS cases	DCS (%)	mean BGI	VGE (any Grade)	VGE (Grade IV)
1a	4.3	3	11 0	34.5	4	36.3	29.7	7	4
1b	4.3	3	13 0	32.3	3	23.0	56.3	11	7
1b10.2	10.2	12	13 0	32.3	0	0	19.7	n/a	n/a
1c	4.3	3	12 0	32.0	4	33.3	53.7	7	6
1c10.2	10.2	12	12 0	32.0	0	0	19.7	n/a	n/a
1d	4.3	3	3 0	39.6	2	66.6	58.6	3	2
1d10.2	10.2	18	3 0	39.6	0	0	21.9	n/a	n/a
2a	4.3	4	23 0	31.6	7	30.4	35.7	15	8
2b	4.3	4	22 0	31.5	6!	27.3	64.7	10	7
2b10.2	10.2	12	22 0	31.5	0	0	19.5	n/a	n/a
3a	4.3	6	28 0	31.0	6	21.4	41.9	13	11
3b	4.3	6	35 0	30.1	8	22.8	45.2	20	8
3b10.2	10.2	12	35 0	30.1	0	0	1.0	n/a	n/a
3c	4.3	6	14 0	32.5	3	21.4	29.7	5	1
3d	4.3	6	12 0	28.5	2	16.6	32.5	5	2
4a	4.3	3	12 0	30.1	1	8.3	28.0	7	3
4a10.2	10.2	12	12 0	30.1	0	0	1.0	n/a	n/a
4b	4.3	3	12 0	30.1	0	0	36.4	2	1
4c	4.3	3	12 0	30.1	0	0	18.7	4	1
4d	4.3	3	12 0	30.1	0	0	19.0	0	0
4e	4.3	3	12 0	30.1	0	0	18.0	4	1
4f	4.3	3	12 0	30.1	0	0	17.7	0	0
5a	4.3	6	19 19	31.5	4	10.5	28.5	11	4
5b	4.3	6	11 0	32.0	0	0	1.0	0	0
6	6.0	6	15 14	32.9	1	3.4	21.1	3	0
610.2	10.2	24	15 14	32.9	0	0	1.0	n/a	n/a
7a	6.5	3	11 0	28.2	4!!	36.3	25.6	8	6
7b	6.5	3	11 0	28.2	2	18.2	25.6	8	4
8a	6.5	3	29 11	32.4	7	17.5	25.6	20	13
8b	6.5	3	30 11	32.6	10!	24.4	25.5	22	17
9a	6.5	3	15 9	32.1	1	4.1	25.6	12	7
9b	6.5	3	14 9	33.8	2!	8.7	25.6	6	1
9c	4.3	3	9 2	34.8	3	27.3	25.6	5	4
9d	4.3	3	6 1	36.4	0	0	24.7	2	0
9e	4.3	3	7 0	34.5	0	0	21.4*	2	0
10	10.11	3	14 5	31.7	1	5.2	17.0	6	3
11a	4.3	4	16 12	33.2	3	10.7	38.5	9	4
11b	6.5	2	1 3	39.5	0	0	18.2	1	0
Phase I	4.3	4	35 14	29.4	9	18.3	41.7*	24	2
Phase II	4.3	4	38 12	32.2	0	0	40.8*	15	3
Phase III	4.3	4	8 2	29.4	2!	20.0	43.4*	2	1
Phase IV	4.3	4	50 15	30.4	8	12.3	42.8*	26	9

Phase V-1	4.3	4	7	3	31.2	3	30.0	43.9*	6	2
Phase V-2	4.3	4	2	2	42.0	1!	25.0	42.7*	4	2
Phase V-3	4.3	4	39	11	36.9	7	14.0	41.3*	25	5
Phase V-4	4.3	4	4	3	31.1	3	42.8	35.8*	3	1
Phase V-5	4.3	4	38	11	32.1	2	4.1	36.3*	14	8

P2 is the ambient pressure in the altitude chamber, ! one case was classified as Type II DCS; !! 2 were classified as Type II DCS. n/a is not applicable since monitoring for VGE was not performed. \*PB included prescribed exercise; all others were resting during PB.





REPORT DOCUMENTATION PAGE			Form Approved OMB No. 0704-0188	
Public reporting burden for this collection of information is estimated to average 1 hour per response, including the time for reviewing instructions, searching existing data sources, gathering and maintaining the data needed, and completing and reviewing the collection of information. Send comments regarding this burden estimate or any other aspect of this collection of information, including suggestions for reducing this burden, to Washington Headquarters Services, Directorate for Information Operations and Reports, 1215 Jefferson Davis Highway, Suite 1204, Arlington, VA 22202-4302, and to the Office of Management and Budget, Paperwork Reduction Project (0704-0188), Washington, DC 20503.				
1. AGENCY USE ONLY (Leave Blank)	2. REPORT DATE November 2014	3. REPORT TYPE AND DATES COVERED Technical Publication		
4. TITLE AND SUBTITLE Probabilistic Assessment of Treatment Success for Hypobaric Decompression Sickness			5. FUNDING NUMBERS	
6. AUTHOR(S) Johnny Conkin; Andrew F.J. Abercromby; Joseph P. Dervay; Alan H. Feiveson; Michael L. Gernhardt; Jason R. Norcross; Robert Ploutz-Snyder; James H. Wessel, III				
7. PERFORMING ORGANIZATION NAME(S) AND ADDRESS(ES) Lyndon B. Johnson Space Center Houston, Texas 77058			8. PERFORMING ORGANIZATION REPORT NUMBERS S-1175	
9. SPONSORING/MONITORING AGENCY NAME(S) AND ADDRESS(ES) National Aeronautics and Space Administration Washington, DC 20546-0001			10. SPONSORING/MONITORING AGENCY REPORT NUMBER TP-2014-218561	
11. SUPPLEMENTARY NOTES				
12a. DISTRIBUTION/AVAILABILITY STATEMENT Unclassified/Unlimited Available from the NASA Center for AeroSpace Information (CASI) 7115 Standard Hanover, MD 21076-1320 Category: 52			12b. DISTRIBUTION CODE	
13. ABSTRACT (Maximum 200 words) The Hypobaric Decompression Sickness (DCS) Treatment Model links a decrease in computed bubble volume from increased pressure, increased oxygen (O2) partial pressure, and passage of time during treatment to the probability of symptom resolution [P(symptom resolution)]. The decrease in offending volume is realized in 2 stages: a) during compression via Boyle's law and b) during subsequent dissolution of the gas phase via the O2 window. We established an empirical model for the P(symptom resolution) while accounting for multiple symptoms within subjects. The data consisted of 154 cases of hypobaric DCS symptoms along with ancillary information from tests on 56 men and 18 women. Given the low probability of DCS during extravehicular activity and the prompt treatment of a symptom with guidance from the model, the symptom and the gas phase are likely to resolve with minimal resources and minimal impact to astronaut health, safety, and productivity.				
14. SUBJECT TERMS decompression sickness; extravehicular activity; hypobaric atmospheres; decompression models, denitrogenation			15. NUMBER OF PAGES 236	16. PRICE CODE
17. SECURITY CLASSIFICATION OF REPORT Unclassified	18. SECURITY CLASSIFICATION OF THIS PAGE Unclassified	19. SECURITY CLASSIFICATION OF ABSTRACT Unclassified	20. LIMITATION OF ABSTRACT Unlimited	



---