

April 26, 2023

NASA Advisory Council

ARTEMIS

Moon to Mars Overview and Status

Amit Kshatriya, Deputy Associate Administrator

Lakiesha Hawkins, Assistant Deputy Associate Administrator

Steve Creech, Assistant Deputy Associate Administrator, Technical

NASA HQ | Washington, D.C.

Outline



- Artemis II Mission Status
- Artemis III Mission Status
 - Starship HLS: Propellant Transfer Demo ConOps
- Artemis IV Mission Status
- Artemis V Mission Status
- Mars Campaign Office – Mars Risk Reduction Through Artemis
- M2M Risk Management



ARTEMIS

Artemis II Mission Status

Artemis II Mission Status



Mission Operations

- Exploration Mission Analysis Cycle 2.4 underway focusing on Bermuda overflight, Orion heatshield downrange constraints implementation, and Aux burn time constraints with a focus on prep for Certification of Flight Readiness (CoFR). Targeting summer 2024 for completion.

Orion

- Completed initial power on of the Crew & Service Module (CSM) and successfully completed integrated functional testing.
- Ongoing investigations related to off-nominal qualification testing of the Crew Module battery is in work.
- Investigation for the Artemis III ECLSS digital motor controller (DMC) completed.

SLS

- Core Stage final integrated and functional test completed in January. All four RS-25 engines installed.
- Interim Cryogenic Propulsion Stage (ICPS) is scheduled for handover to EGS in spring 2024. Launch Vehicle Stage Adaptor (LVSA) is integrated and in storage; ready for delivery to EGS.
- All solid rocket motor segments, nozzle aft exit cones, and aft skirts for Artemis II have been delivered to KSC and flight processing is underway.
- Block 1 Crew delta Design Certification Review (DCR) will kick off in May.

EGS

- Mobile Launcher 1 refurbishment is still progressing to support Artemis II processing.
- Completed Underway Recovery Test 11 (URT-11). Crew Module Test Article (CMTA) undergoing post URT-11 readiness of its validation event.



Images (L to R): (1) Artemis II Crew & Service Module; (2) Exploration Ground Systems conducts a water flow test with the mobile launcher; (3) Artemis II spacecraft lifted into Altitude Chamber for EMI/EMC testing; (4) Artemis II ICPS In Storage Cell at ULA DOC at CCSFS; Hardware Acceptance Review complete; (5) Exploration Ground Systems conducts Underway Recovery Test 11

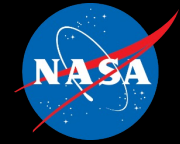

ARTEMIS

Artemis III Mission Status

Artemis III Mission Status



Mission Operations

- Science instrument selection completed, 3 instruments competitively selected.
- Exploration Mission Analysis Cycle 3.3 underway focusing on near-rectilinear halo orbit (NRHO) to low lunar orbit (LLO) to surface operations including abort availability and critical trajectory maneuver performance margins. Also, assessing EVA surface traverse distance constraints. Targeting late summer 2024 for completion.

Orion

- Crew Module (CM) mechanical and avionic hardware installations underway, successful installation of Environmental Control Life Support System harnessing, Air Revitalization System ducting and ammonia tanks.
- Continuing harness routing and installation in the Crew Module Adapter (CMA).
- European Service Module (ESM) assembly is undergoing propulsion system final installation and testing.

SLS

- All Artemis III hardware is in manufacturing flow with completion and readiness for delivery to EGS beginning in 2024 through early 2025.
- ICPS transferred to the ULA Delta Operations Center test cell. LVSA, and Orion Stage Adaptor (OSA) scheduled to be complete in 2024.
- Core Stage III scheduled to be complete in 2025 and the engine section work is in progress at the KSC Space Station Processing Facility. VAB High Bay 2 vertical tooling installation has started. All core stage engines are in storage at SSC.
- All solid rocket motor segments (10) for Artemis III have been cast and are in storage in Utah.

EGS

- No significant changes planned for Artemis III.

HLS

- Completed third Starship/Super Heavy flight test on March 13, 2024.

EHP

- Completed Axiom Preliminary Design Review and Phase 1 Safety Review.
- Completed Axiom Crew Capability Assessment in Partial Gravity offload system.

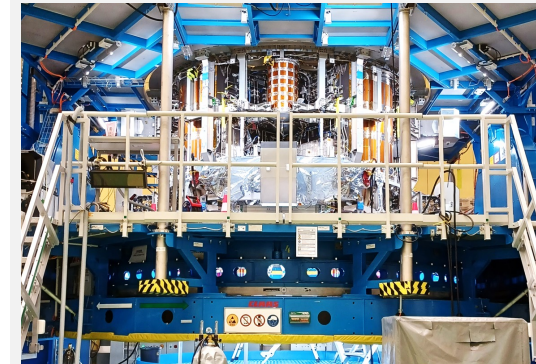

Images (L-R): 1) European Service Module (ESM) 3 undergoing final propulsion testing in Bremen, Germany; 2) Artemis III ICPS transferred to ULA DOC Test Cell; 3) SpaceX Integrated Flight Test #3 launched on 3/14/24, credit: SpaceX; 4) Axiom – Crew Capability Assessment

Starship HLS: Propellant Transfer Demo ConOps

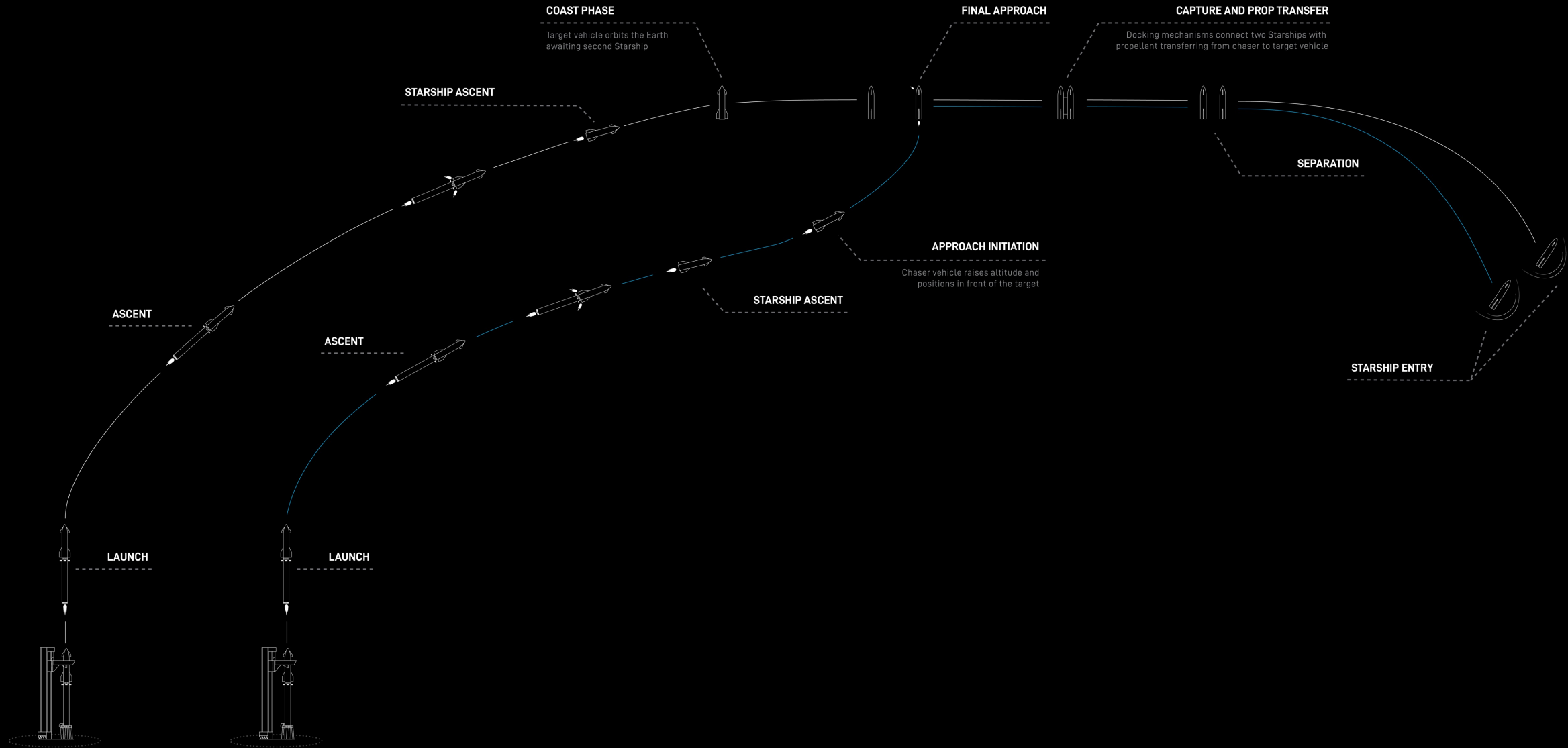

Starship HLS Prop Transfer Demo



Large-scale, Starship-to-Starship, cryogenic propellant transfer is a critical capability necessary to conduct the Starship HLS mission.

MISSION ARCHITECTURE

Launch Pad: Starbase

Launches: Two Starships (Target & Chaser)

NASA Payloads: None



Starship Target

- Launches first
- Receives propellant during transfer
- Has active docking mechanisms
- Has passive relative navigation features
- Performs de-orbit burn



Starship Chaser

- Launches second
- Transfers the propellant to target
- Has passive docking mechanisms
- Has active relative navigation sensors
- Performs de-orbit burn

PATH TO DEMONSTRATION

| 2024 | | | 2025 |
|---|--|--|--|
| <p>Tipping Point Propellant Transfer Demo</p> <p>On-orbit demonstration of the transfer of cryogenic propellant between tanks on a single Starship</p> <p>✓ <i>Performed during Flight 3</i></p> | <p>Propellant Transfer Demo Flight System Review</p> <p>Overview of:</p> <ul style="list-style-type: none"> • Mission architecture • High-level Starship & hardware designs • Key subsystems • Preliminary integrated models & analyses <p>✓ <i>Completed</i></p> | <p>Propellant Transfer Hardware Development</p> <p>Build, test, and integration of:</p> <ul style="list-style-type: none"> • Docking mechanisms • Relative navigation sensors • Quick disconnects • Hot gas thrusters <p><i>In Work</i></p> | <p>Ship-to-Ship Propellant Transfer Demo</p> <ul style="list-style-type: none"> ✓ Launch two Starships such that they can meet on orbit ✓ Rendezvous and dock two Starships together ✓ Transfer propellant between two Starships |

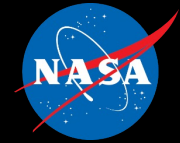

ARTEMIS

Artemis IV Mission Status

Artemis IV Mission Status



Mission Operations

- Exploration Mission Analysis Cycle 4.0 is underway focused on developing the nominal mission design with heavy focus on impacts to mission availability (I-HAB mass, SLS performance, Orion propellant), multi-element aggregation concept of operations at Gateway, and overall mission duration to accomplish mission objectives. Targeting summer 2024 for completion.

Orion

- Crew Module is at KSC, installation of secondary structures is underway. Successfully completed several bracket installations, as well as batteries and propulsion system components.
- European Service Module integration progressing in Bremen, Germany.

SLS

- Production on the Engine Section, Intertank, Forward Skirt, LOX Tank, and LH2 Tank for the Core Stage in various stages of production. Final processing of the Core Stage RS-25 Engines is in-work at SSC and scheduled to be completed in spring 2024.
- Booster motor segments are in production as well as the EUS, USA, and PLA articles for structural test, qualification and flight.

EGS

- Mobile Launcher 2 (ML-2) construction and steel erection is progressing, including all ML-2 base primary trusses/girders and 3 of 7 Tower Module primary structures.

Gateway

- First PPE Bi-Propellant Tank received at Maxar.
- Maxar (PPE) completed their CDR, and Program subsystem CDRs are underway
- Completed 1 of 4 flight Integrated Modular Blankets Assemblies (IMBAs).
- HALO primary structure friction stir welding complete; finalizing residual defect repairs in prep for static load test.

HLS

- Completed SpaceX milestones: Powered Utilization Payload Interface Review (10/10/2023) and 4-Person Elevator Sortie Demo Review (11/13/2023)

EHP

- xEVA Supported Gateway-EVA verification reviews for HALO Critical Design Review.

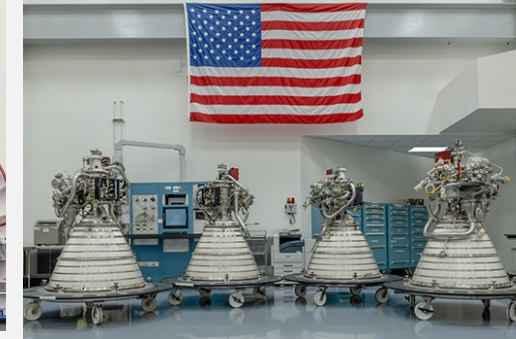
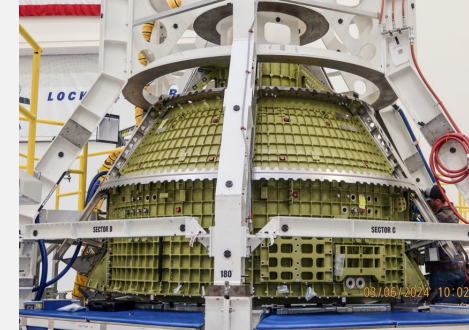

Images (L to R): 1) Artemis IV Crew Module undergoing secondary structure installations; 2) Artemis IV Block 1B EUS engines in storage at SSC; 3) Mobile Launcher-2 Tower and Base Construction; 4) HALO Lunar Communications System structural model fit check

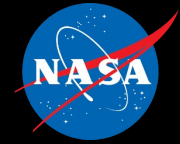

ARTEMIS

Artemis V Mission Status

Artemis V Mission Status



Orion

- CM Pressure Vessel (PV) is under construction at Michoud Assembly Facility (MAF).
- SM assembly underway at ESA/Airbus in Bremen, Germany.

SLS

- Artemis V demonstrates the on-ramp the first RS-25 Production Restart engines. Completed all Retrofit 3b certification tests to-date and will complete remaining certification tests this spring.

EGS

- Developing flight hardware ground processing timelines, including ESPRIT.

Gateway

- Reviewing requirement implementation strategies in preparation for the ESPRIT-Refueling Module (ERM) Preliminary Design Review (PDR).

HLS

- Blue Origin Preliminary Design Review (PDR) held in Feb 2024.

EHP

- NASA has selected Intuitive Machines, Lunar Outpost, and Venturi Astrolab to advance capabilities for a lunar terrain vehicle (LTV) that Artemis astronauts will use to travel around the lunar surface, conducting scientific research during the agency's Artemis campaign at the Moon and preparing for human missions to Mars.

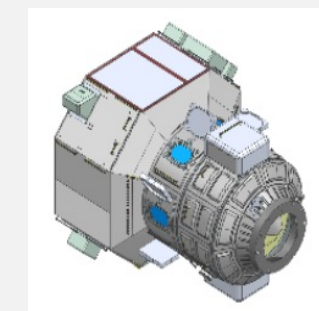
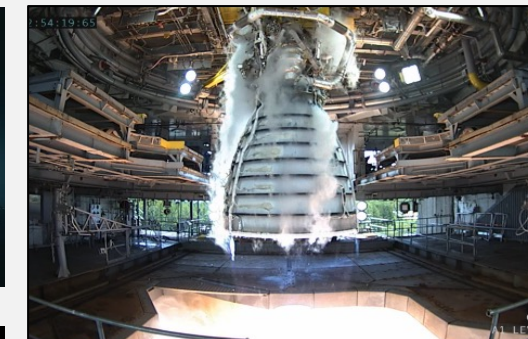

Images (L-R): 1) Artist's concepts of Lunar Terrain Vehicles: Venturi Astrolab's FLEX; Intuitive Machines' Moon RACER and Lunar Outpost's Lunar Dawn. 2) Artist concept of the Blue Origin's Blue Moon lander. 3) SLS RS-25 Engine. 4) Gateway ESPRIT Refueling Module.



Mars Campaign Office

Mars Campaign Office: Mars Risk Reduction Through Artemis



The Mars Campaign Office (MCO) is currently leading technology development in 58 different task areas across its five Domains: Crew Health & Performance, Earth Independent Operations, Environmental Control & Life Support Systems, Surface Systems, and Transportation & Vehicle Systems.

Recent Accomplishments Include:

- **Thermal Amine Swingbed (TAS)** CO2 Removal System controller change out and check out was successfully completed in January. The TAS is currently running and 100% of ISS CO2 removal is being performed by MCO hardware (TAS and Four Bed CO2 removal system) during nominal 7-crew operations.
- **Vibration Isolation and Stabilization (VIS)** system designed for use with the European Enhanced Exploration Exercise Device (E4D) engineering development unit assembly was completed.
- **Spacecraft Atmosphere Monitor Technology Development Unit-2 (SAM TDU2)** was installed on the ISS on December 5. SAM TDU2 has commenced real time data downlink to the Mission Control Center ETHOS console. The data allows flight controllers to directly compare the SAM, which provides both major constituents and trace gas cabin atmospheric data to the state of the art atmospheric sensors currently operating on ISS.
- **Crew Health And Performance Exploration Analog (CHAPEA)** Mission 1 is over 250-days into its 378-day mission and operating nominally with successful data collections to date. Mission 2 application release for crew selection occurred February 16.
- **Saffire VI** flammability experiment successfully completed its experiments on the Cygnus spacecraft and data download was completed in January. This completes the Saffire set of experiments to test material flammability and flame propagation in 0-g. Future tests will evaluate these phenomena in lunar environments. All of the test results will help to anchor models for future spacecraft and suit design.
- **Autonomous Satellite Technology for Resilient Application (ASTRA)** a hardware and software payload launched with the host Sidus Space Lizzie Sat-1 (LS-1) satellite on March 6. The ASTRA flight software will autonomously operate targeted mission objectives and monitor the health of the satellite power and Guidance Navigation & Control (GNC) via a vehicle system manager throughout the lifetime of the mission and provide that advisory data to the LS-1 satellite flight team.



Images (L-R): 1) Side views of material samples with different airflow rates. Ambient conditions: ~30% oxygen at 7.9 psia; 2) E4D Keyhole Assembly Fit Check with VIS at NASA; 3) Installation of SAM TDU2 on ISS



ARTEMIS

M2M Risk Management

Moon to Mars Approach to Risk Management

from the Moon to Mars Implementation Plan



- The fundamental responsibility of the M2M organization, at all levels, is the **active, integrated management of risks to the Artemis Campaign** through the **deep embedding of risk-informed decision-making throughout M2M**.
- M2M broadly defines risk management as the **control of known and potential deviations from the M2M technical, operational, or programmatic baseline**, including but not limited to, risks held in the Programs and M2M risk management systems, hazards, concerns, watch items, liens, and threats.
- Risk management is an integral part of the mission and phase-based integration approach that M2M has implemented for delegation of responsibilities to the Programs. All levels of the M2M organization are responsible for actively identifying and effectively communicating known or potential risks to the M2M baseline.
- **Moon to Mars Programs and M2M Program Office Directors are responsible for managing and mitigating risks within their delegated areas of responsibility.** Risk and mitigations are required to be explicitly incorporated into each topic at all M2M control boards, fostering continuous focus on risk at all levels. Risks that exceed the authority delegated to a Program and/or M2M Program Office Division are elevated to the M2M DAA, and if necessary, to the Mission Directorate or Agency level, for final adjudication and risk acceptance.

Risk Management will flow from the evolving M2M Implementation Plan

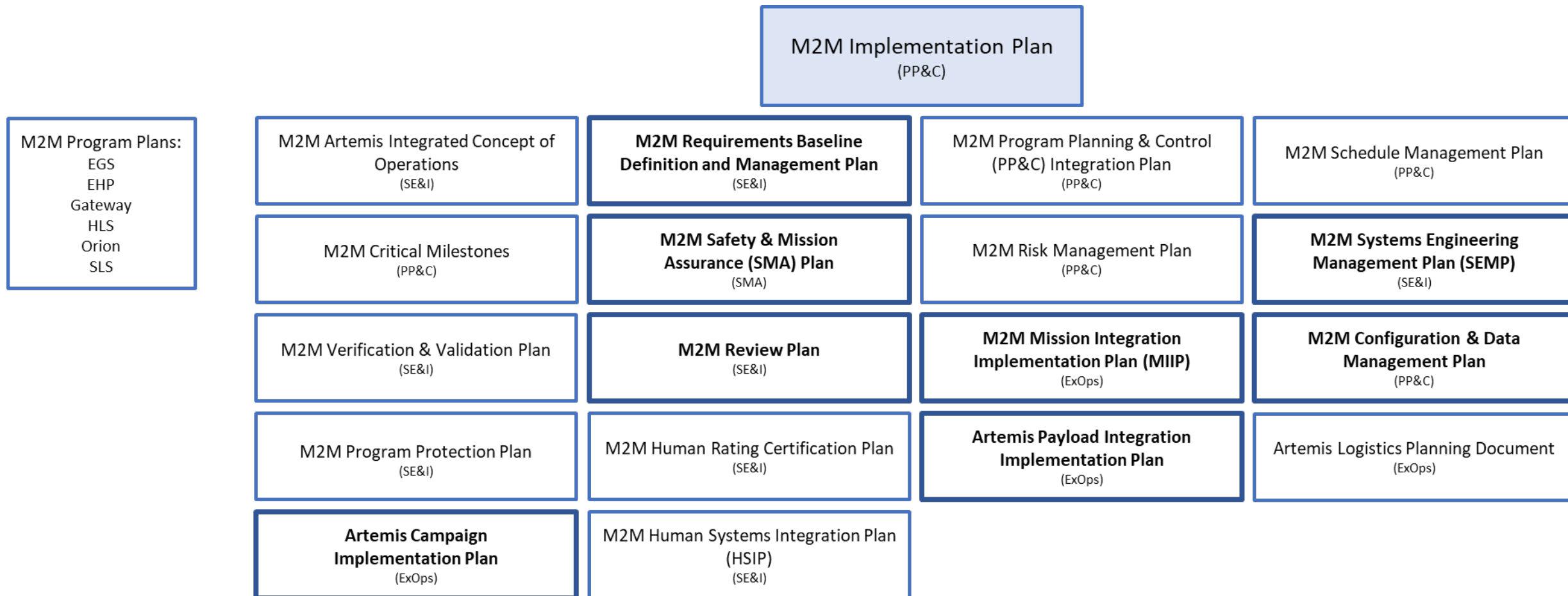

* Plans in bold have their own document trees