

NASA Small Spacecraft Technology

Accomplishments, Opportunities and Plans

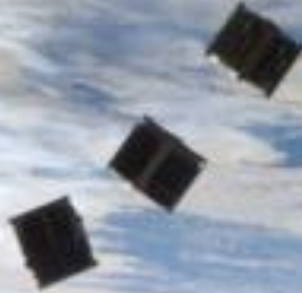

Cubesat Developers Workshop

April 21, 2016

**Andrew Petro
Space Technology Mission Directorate
NASA Headquarters
Washington DC**



SPACE TECHNOLOGY MISSION DIRECTORATE



NINE PROGRAMS

- NASA Innovative Advanced Concepts (NIAC)
- Space Technology Research Grants
- NASA Center Innovation Fund
- Small Business Innovation Research (SBIR & STTR)
- Game Changing Development
- Small Spacecraft Technology
- Centennial Challenges
 - * Cube Quest Challenge
- Flight Opportunities
- Technology Demonstration Missions

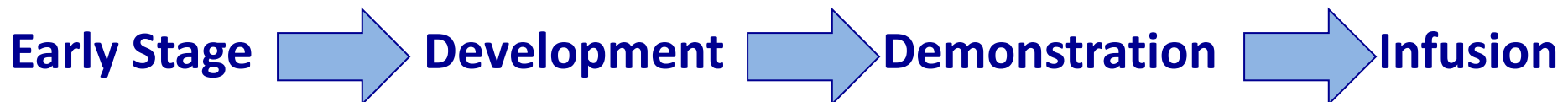

Small Spacecraft Technology

Small, Affordable, Rapid, & Transformative

Objectives:

- Develop and demonstrate new capabilities employing the unique features of small spacecraft for NASA's missions in science, exploration and space operations
- Promote the small spacecraft approach as a paradigm shift for NASA and the larger space community.

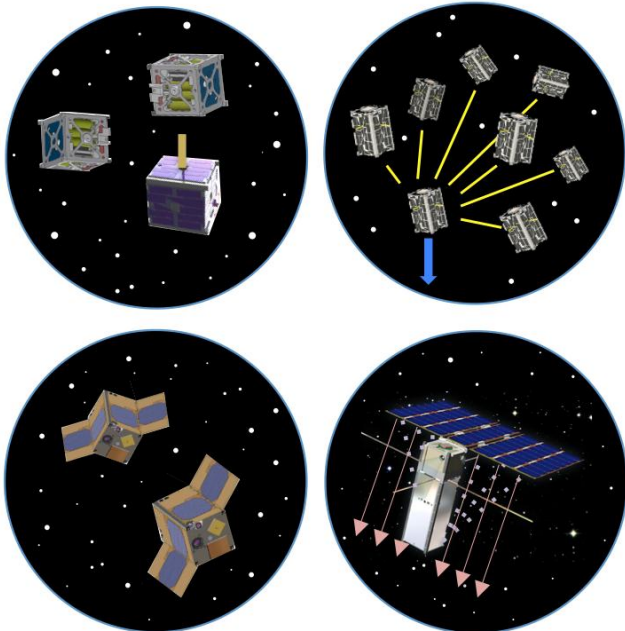

Implementing through:

- Contracts with industry
- Directed NASA projects
- Collaborations with universities
- Partnerships with other NASA organizations and other agencies

**Six demo missions planned for
2015-16 with 16 satellites**

www.nasa.gov/smallsats

Edison Demonstration of Smallsat Networks

EDSN and Nodes

NASA Ames, Montana State U and Santa Clara U

Demonstration of autonomous network communications with multiple low-cost satellites based on smartphone processors (Phonesat heritage)

EDSN: 8 cubesats, Nodes: 2 cubesats

Each includes a high-energy particle detector

EDSN Launch – Nov 2015 – lost due to launch vehicle failure

Nodes Launch – Dec 2015 to ISS **Deployment – May 2016**

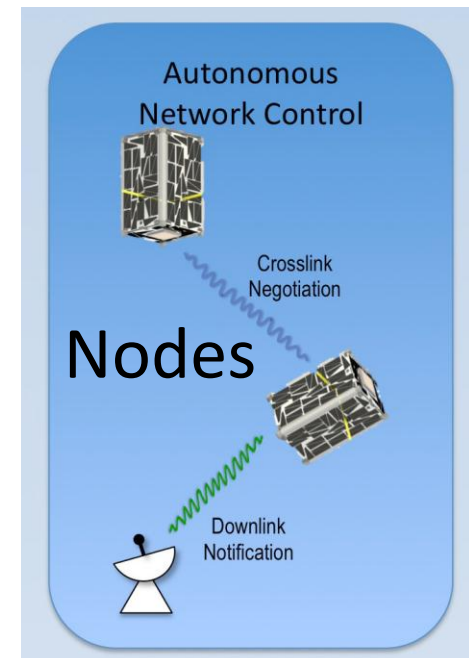
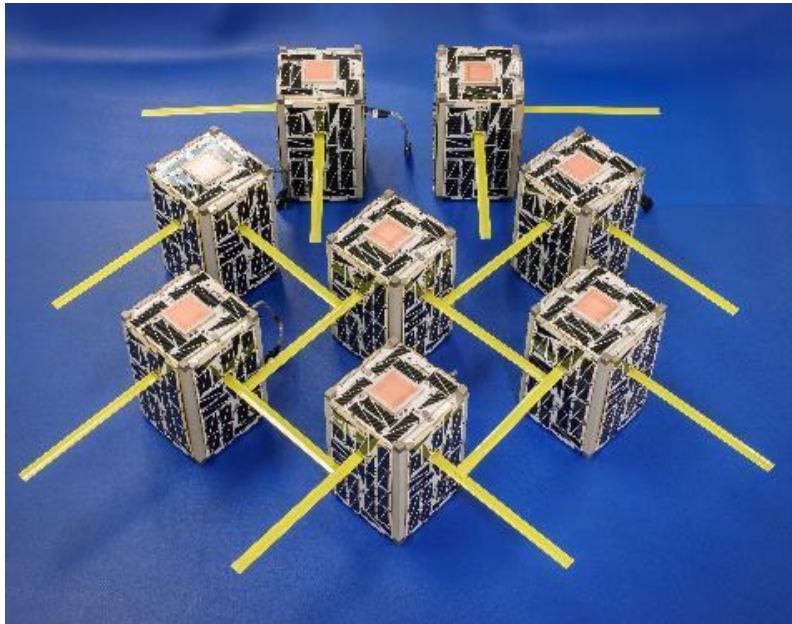

Optical Communications and Sensor Demonstration OCSD



Aerospace Corporation

Dramatic improvement in space to ground laser communications with 1.5U cubesats - plus proximity operations, laser ranging and tracking, and propulsion.

Launches – Oct 2015 and June 2016

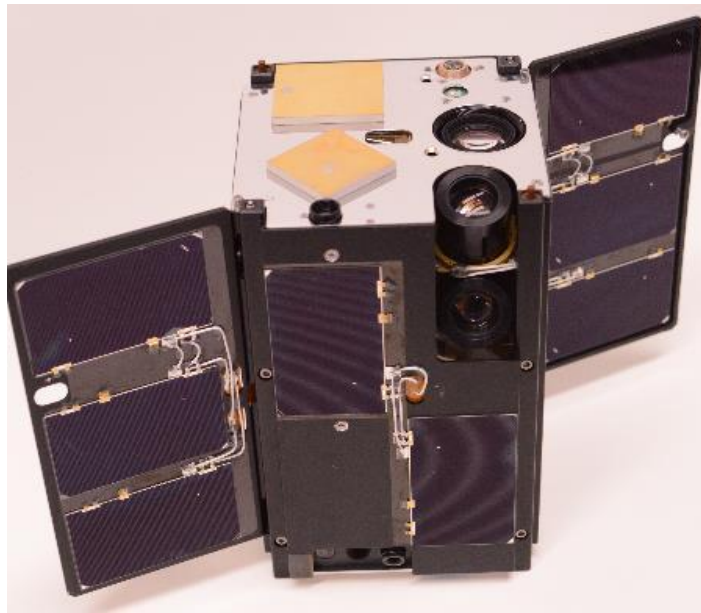

First flight unit

Mission 1

Demo: Pointing & Laser Downlink Engineering Development Unit

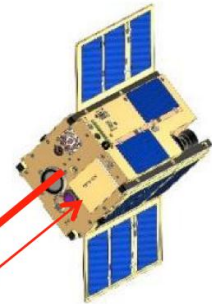

Laser ranging & tracking between satellites

Mission 2

Demo: Proximity Operations & Propulsion

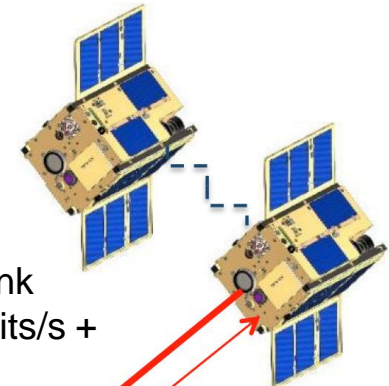

Demo: Downlink 5Mbits/s to 200Mbits/s +

Integrated Solar Array and Reflectarray Antenna ISARA

JPL, Aerospace Corporation, Pumpkin Inc.

Increased Ka-band communication and potential radar remote sensing for low-cost but effective science missions

Launch – June 2016

Technology being used for MARCO cubesat deep space radio relay demonstration

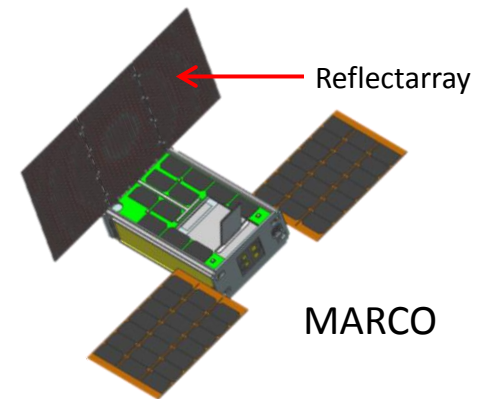
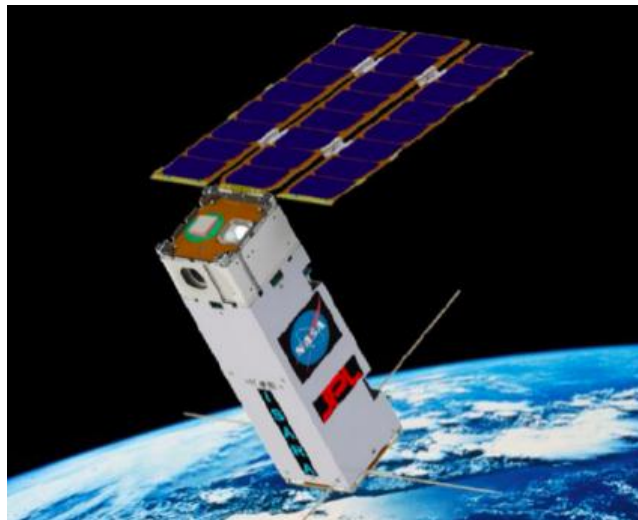
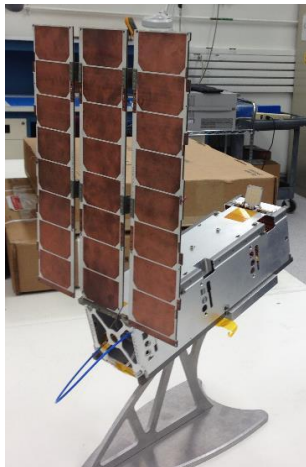
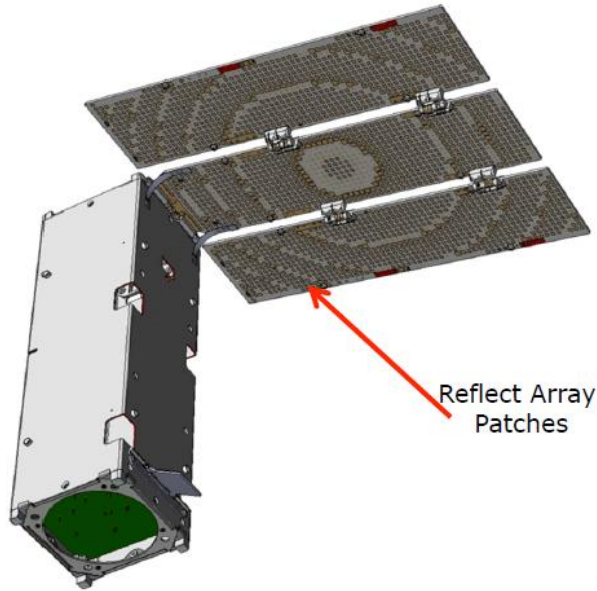

Cubesat Proximity Operations Demonstration CPOD



Tyvak LLC

Formation flight, proximity operations and autonomous rendezvous and docking with two 3U cubesats.

Launch – Mid-to-late 2016

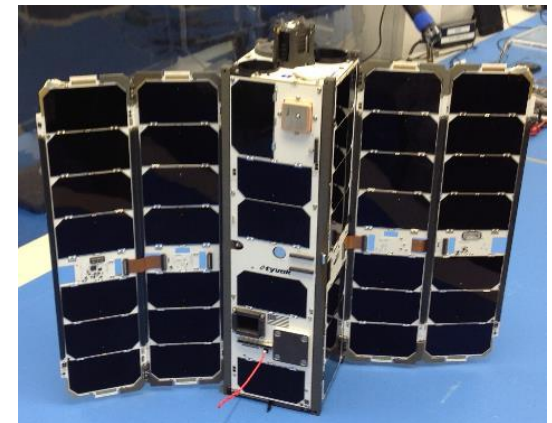
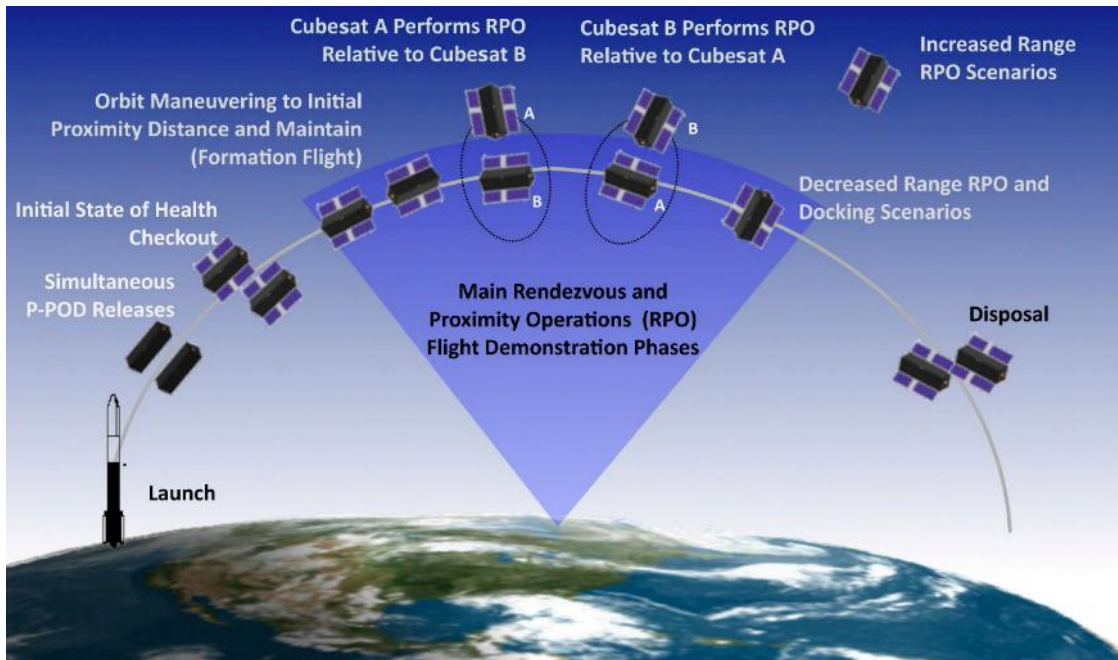
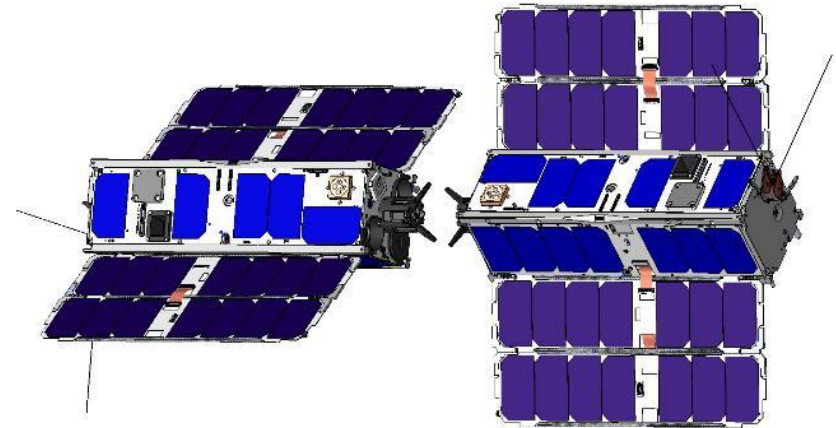

Engineering Development Unit

Iodine Hall Thruster Demonstration Isat

NASA Marshall with NASA Glenn and Busek Co.

Isat will mature the technology for using iodine propellant with a small Hall Effect thruster and demonstrate its operation in space. This technology will enable high ΔV primary propulsion for small spacecraft.

12U cubesat

Target launch in late 2017

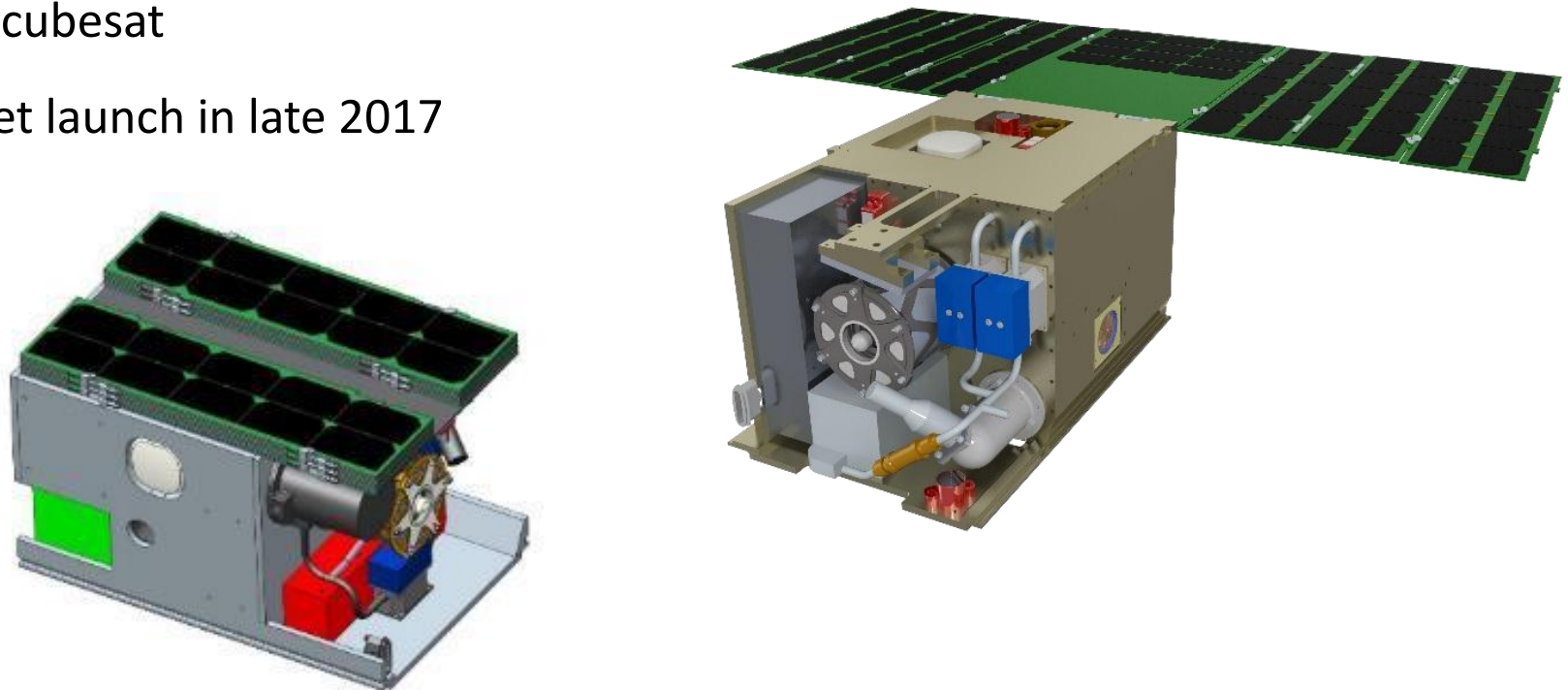

Pathfinder Technology Demonstrator

NASA Ames and NASA Glenn with industry partners for cubesat bus and technology payloads.

The Pathfinder Technology Demonstrator series will demonstrate spacecraft technologies in Earth orbit including new systems for ***propulsion, precise pointing, and high-data-rate communications.***

Current RFP for up to five 6U cubesat buses.

Proposals in review

Technology payloads are being developed through SBIR and Tipping Point contracts and other sources are possible.

Target date for first launch is 2017

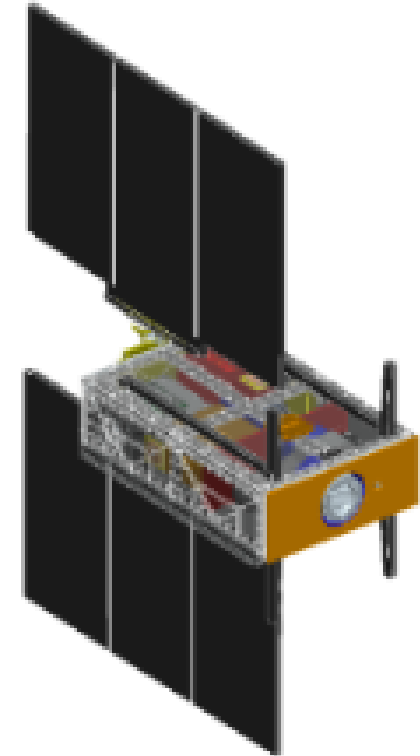

Reference concept for 6U bus

Technology Development

Early Career Projects – NASA + External Partners

- *On-orbit Autonomous Assembly from Nanosatellites*
 - NASA Langley and Cornell University
- *Lightweight Integrated Solar Array and Transceiver*
 - NASA Marshall and Nexolve Inc.



STMD Tipping Point Projects – selected

- *Hyper-XACT Attitude Determination & Control System*
 - Blue Canyon Technologies LLC, Boulder, Colorado
- *Reaction Sphere*
 - Northrop Grumman Support Services Corporation, Millersville, Maryland
- *Hydros Thruster*
 - Tethers Unlimited, Bothell, Washington
- *High-Thrust High- ΔV Green Propulsion for Cubesats*
 - Aerojet Rocketdyne, Inc., Redmond, Washington



Smallsat Technology Partnerships



Cooperative agreements with US universities to develop and/or demonstrate new technologies and capabilities for small spacecraft in collaboration with NASA.

Two year projects

Up to \$100,000 per year, per university

Up to 1.0 FTE in NASA labor per year

13 Projects selected in 2013

8 Projects selected in 2015

Annual solicitations planned starting in 2015

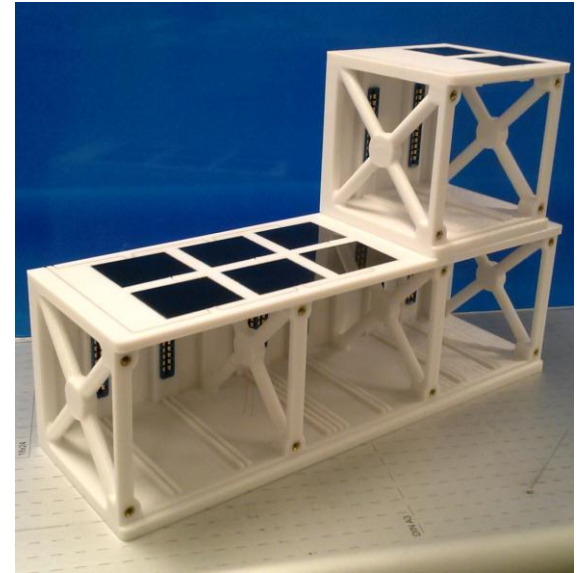

3U Cubesat prototype with embedded copper wire and solar array
(U of New Mexico, UT-El Paso & NASA Glenn)

Smallsat Technology Partnerships



Issued 2016 NRA Appendix on April 8

Topics:

- 1: Enhanced Power Generation and Storage
- 2: Cross-linking Communications Systems
- 3: Relative Navigation for Multiple Small Spacecraft
- 4: Instruments and Sensors for Small Spacecraft Science Missions

Proposals due May 25, 2016

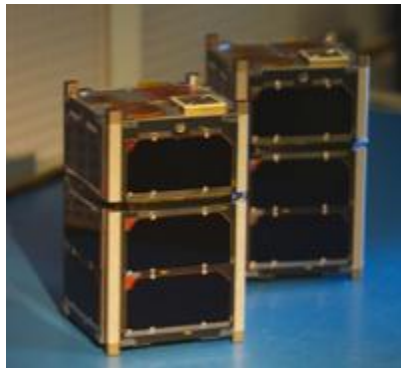

*Montana State/GSFC
Radiation-tolerant Processor*

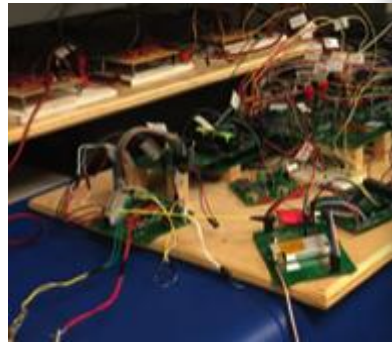

*California State-Northridge/JPL
Low-Temperature Capacitor Flight Demo*

Small Business Innovation Research (SBIR)



Small Spacecraft Technology Topic – created for 2014

- 5 Phase II projects now underway
- 1 SBIR Commercialization Readiness Project underway
- Isat flight project employing an Air Force SBIR for propulsion system development

Anticipate significant growth in SBIR opportunities for Small Spacecraft Technology beginning in the next solicitation – end of 2016

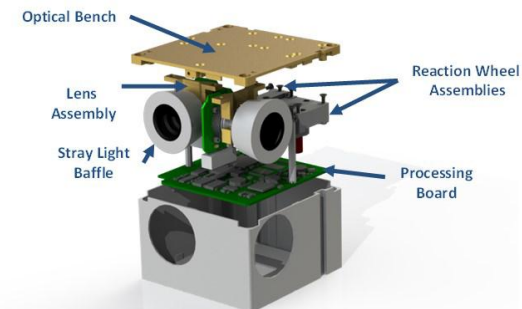
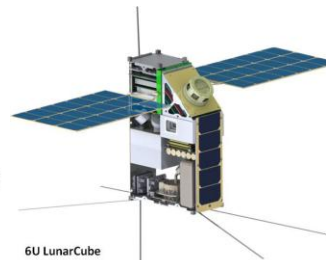
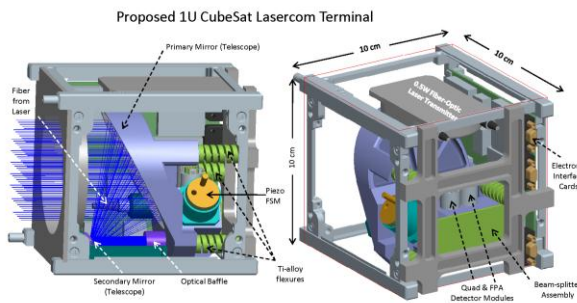



Small Spacecraft Technology State of the Art Report

- Compiled for the SST Program by Ames Engineering with inputs from the larger community
- Originally published in October 2013
- New update completed in December 2015
- Annual update intended, broad participation desired
- Link to report on STMD/SSTP website:

www.nasa.gov/smallsats

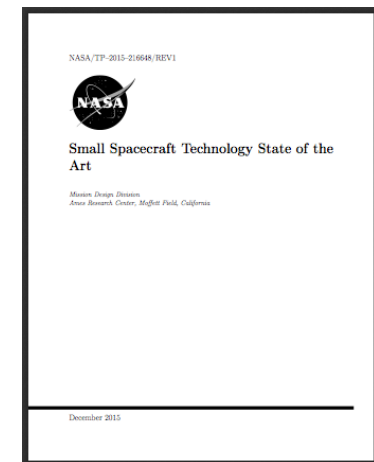



Small Spacecraft Technology

Nationwide Participants and Partners

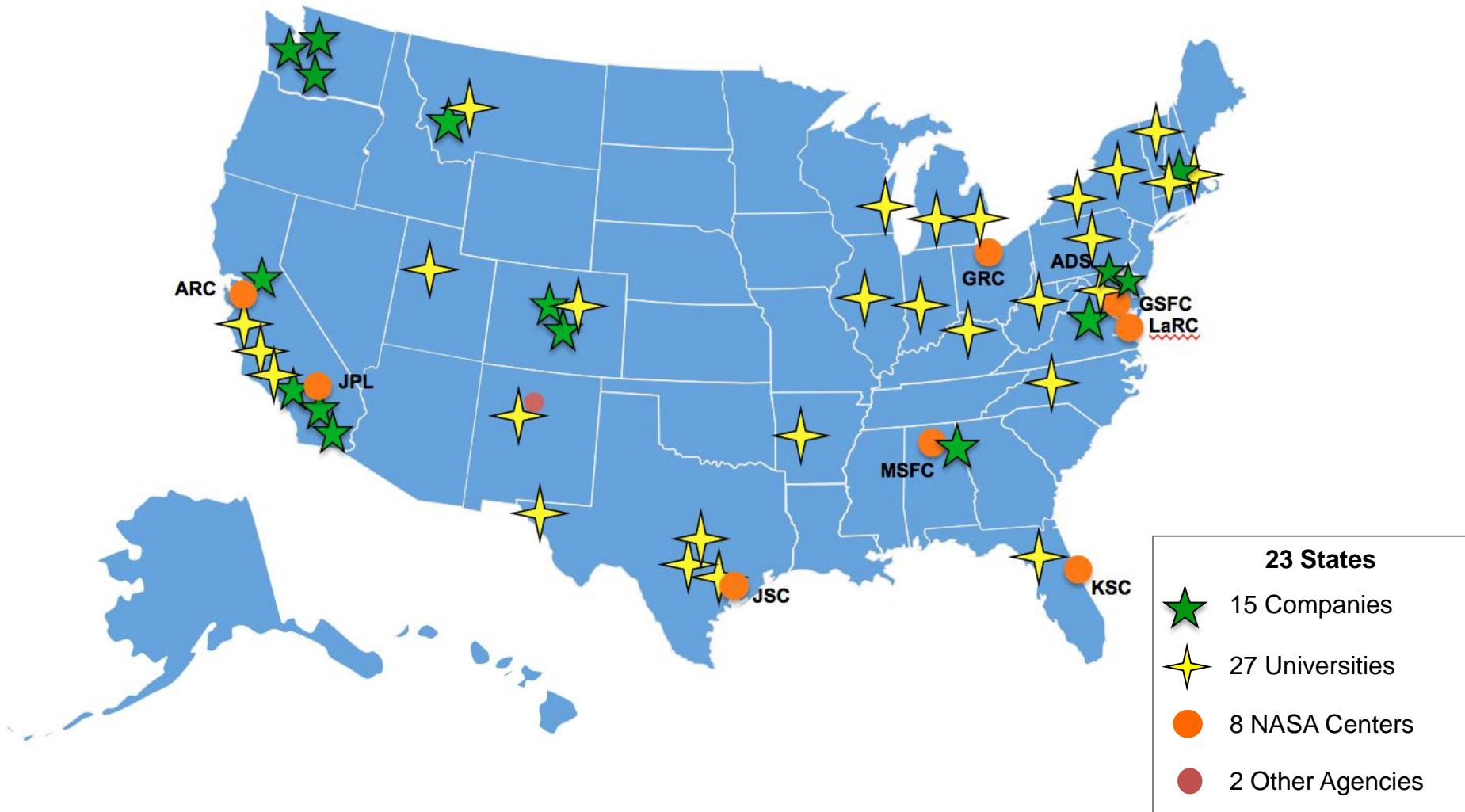

www.nasa.gov/smallsats



Astronomy Night at the White House
October 19, 2015