



NASA's FY2014 Asteroid Strategy

An Integrated Strategy in Support of Human Exploration
And Protection of the Planet

April 10, 2013

Asteroid Strategy

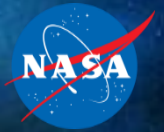

The President announced in April 2010 a human mission to an asteroid. The budget leverages NASA's human and robotic activities for the mission and also accelerates efforts to address potentially hazardous asteroids:

- To protect our planet
- To advance exploration capabilities and technologies for human space flight
- To learn how to best utilize space resources.

The FY14 budget aligns relevant portions of NASA's science, space technology, and human exploration capabilities to plan for the mission.

NASA will build on a rich history of engaging citizen scientists, researchers and individual innovators in this quest.

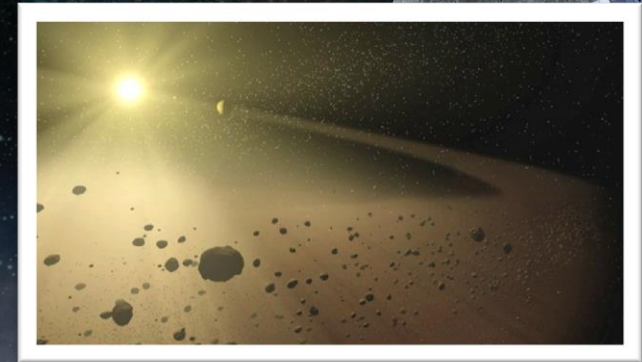

Mission Concept

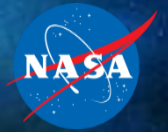

- **Capture and redirect a 7-10 meter diameter, ~500 ton near-Earth asteroid (NEA) to a stable orbit in trans-lunar space**
- **Enable astronaut missions to the asteroid as early as 2021**
- **Parallel and forward-leaning development approach**

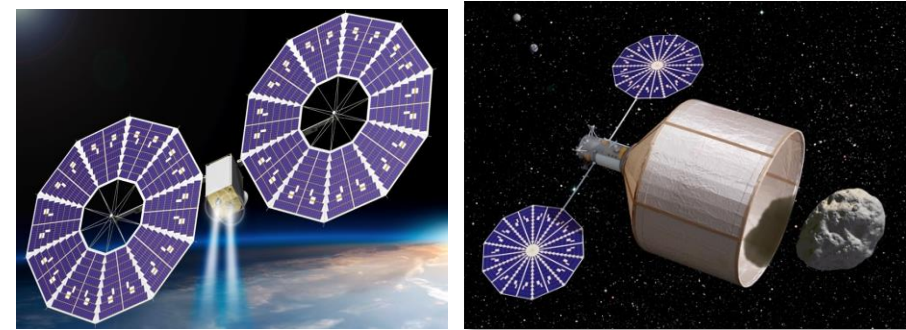
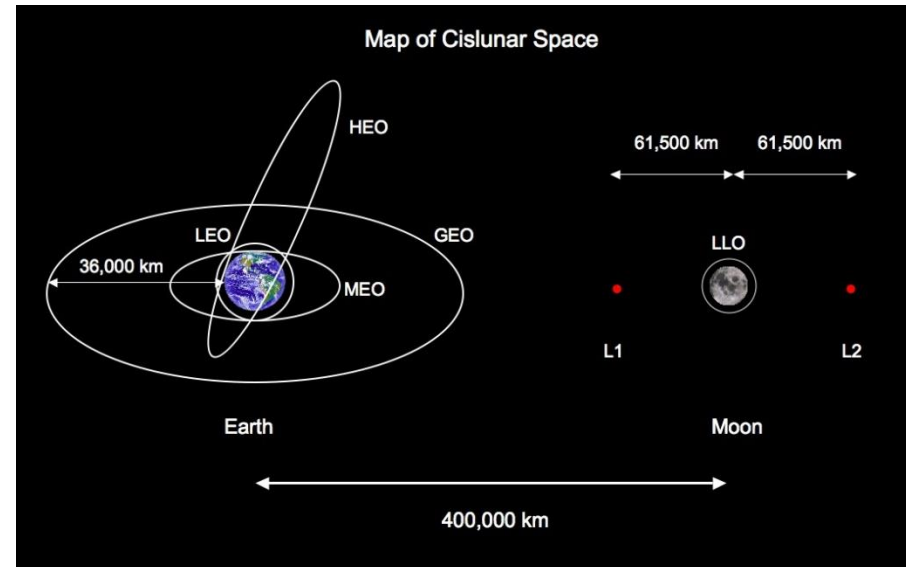

Asteroid Mission Would Consist of Three Main Segments



Identify



Asteroid Identification Segment:

Ground and space based NEA target detection, characterization and selection

Redirect



Asteroid Redirection Segment:

Solar electric propulsion (SEP) based asteroid capture and maneuver to trans-lunar space

Explore



Asteroid Crewed Exploration Segment:

Orion and SLS based crewed rendezvous and sampling mission to the relocated asteroid

Alignment Strategy

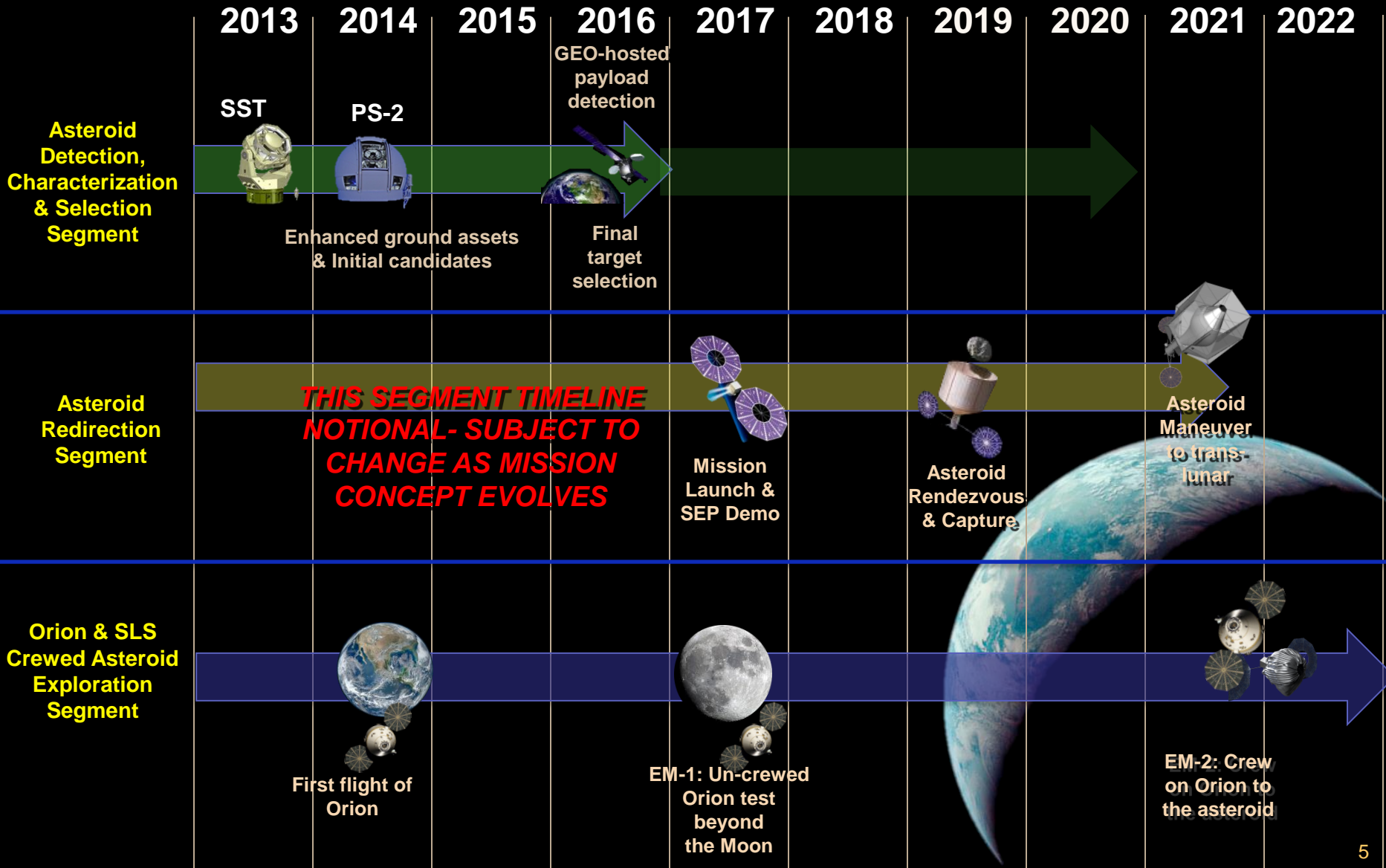

Approach to Accelerate Target Detection and Characterization



- **Need to identify targets that meet**
 - Trajectory
 - Size
 - Spin rate
 - Composition
- **Asteroid Target Detection Options**
 - Utilization of ground telescopes such as Palomar and Panoramic Survey Telescope and Rapid Response System-2
 - Enhanced robotic ground and space-based observations
- **NASA's existing Near Earth Object Observation program is exploring ways to improve detection and characterization efforts**
 - Will develop options and recommend specific actions to augment current capabilities by April 2013
 - Some new targets could be identified via this process
- **The FY2014 investment will enable us to accelerate the rate of discovery of candidate asteroids**

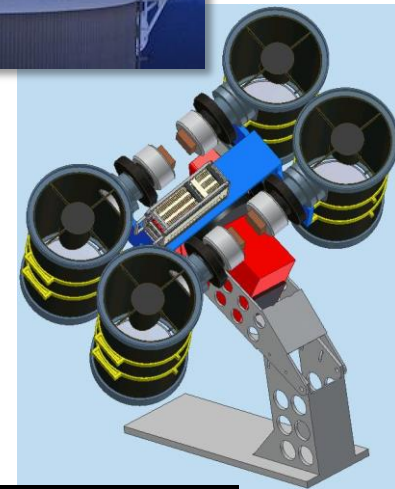

Synergy with STMD Technology Demonstration Mission

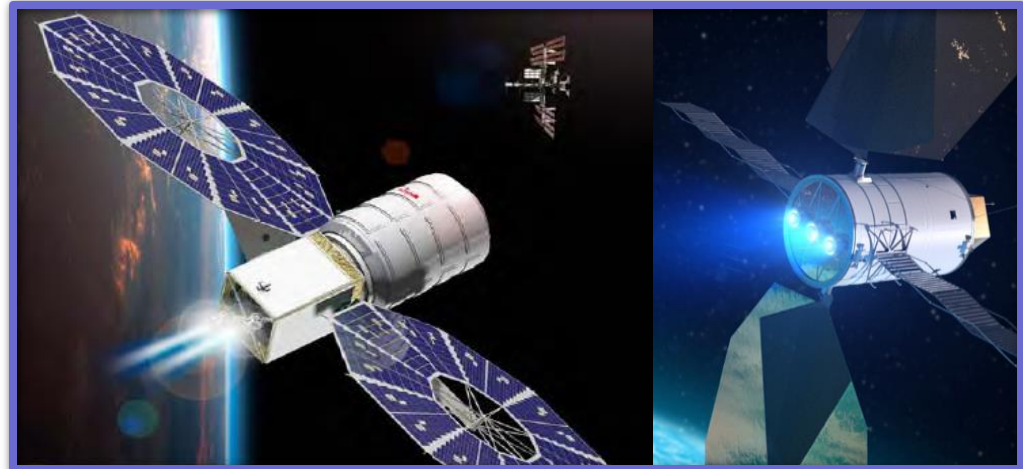

- STMD is planning an affordable demonstration of high-power (~30-50 kW), light-weight solar arrays and Solar Electric Propulsion (SEP)
- A SEP Technology Demonstration Mission (TDM) that will be integrated into an Asteroid Retrieval Mission to validate:
 - New solar array capability
 - High-power electronics and thruster engines
 - Integrated high power SEP system
 - Asteroid transportation

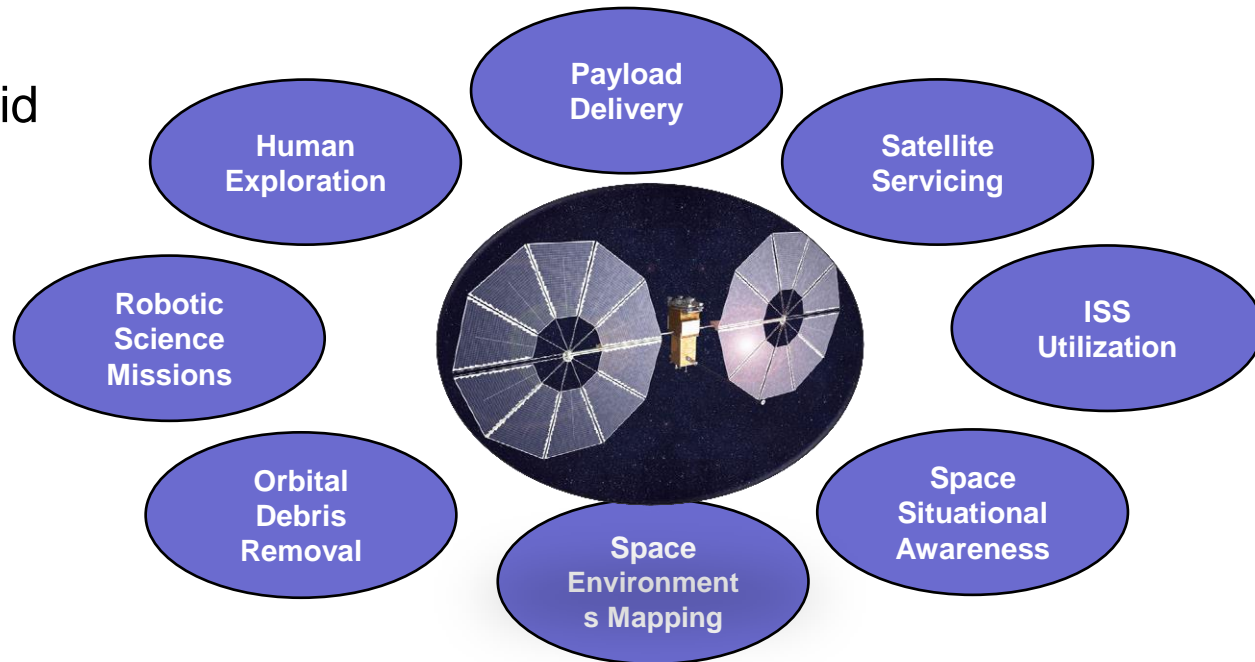

Asteroid Capture Concept

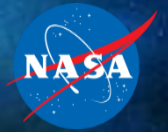

- Approach for rendezvous and capture with a non-cooperative space object
- Most technically challenging aspect of the mission
- Leverage existing work
 - OSIRIS-REx
 - Satellite servicing
- Engage community for best ideas

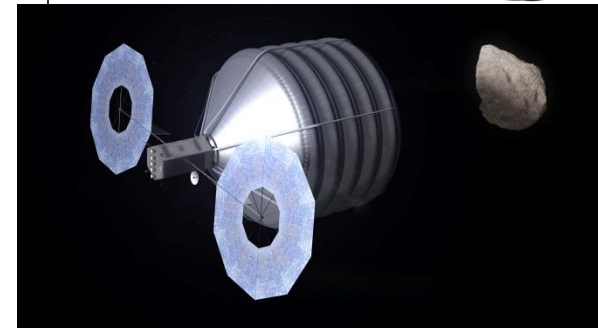
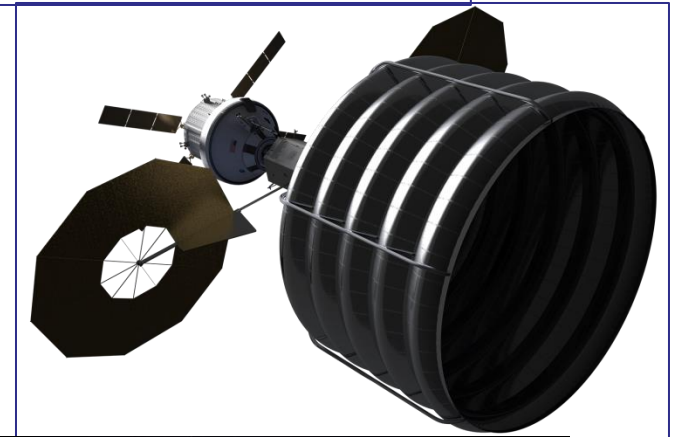
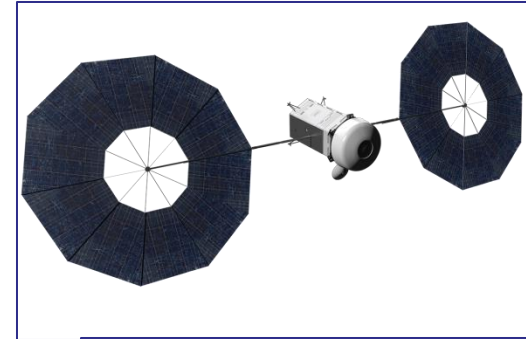

FY2013 Planning Activities



- **NASA has begun study activities led by two teams**
 - Concept definition study for asteroid identification and redirect segments
 - Concept definition study for crew rendezvous and sampling segment
- **Mission Concept Review in late summer of 2013**
 - Provides an assessment of the technical and programmatic feasibility to factor into the FY2015 budget submit
 - Address key management principles with the goal of keeping additional out year levels low by :
 - Lean and agile project management approach
 - Development of minimum success criteria
 - Continued leveraging existing efforts and resources
- **A plan to address and prioritize the efforts above will be established in 2013.**

FY2014 Major Activities

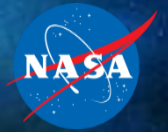

- **Science Mission Directorate's Planetary Science Program plans to:**
 - Implement systematic focus on candidate targets using ground assets
 - Begin study of space-based observation platform
- **Space Technology Mission Directorate plans to:**
 - Accelerate the development of a demonstration of a high-power solar electric propulsion system
 - Begin the design and test of a large-scale solar electric array leveraging investment in ground demonstration of large arrays that was initiated in FY2012
 - Design and build engineering units of the high-power electronics and thruster engines
 - Design large-quantity propellant tank
 - Engage academic and industry for ideas and concepts regarding capture, characterization, sampling, and resource utilization
- **HEOMD's Advanced Exploration Systems plans to:**
 - Begin development of an asteroid capture mechanism
 - Investigate spacecraft control algorithms for capturing and redirecting an asteroid
 - Demonstrate concepts for astronaut extravehicular activity on the asteroid's surface.

Summary

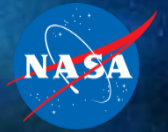

- **NASA's asteroid strategy aligns relevant portions of NASA's science, space technology, and human exploration capabilities for a human mission, advanced technology development, efforts to protect the planet, and engages new industrial capability and partnerships**
- **Leverages existing NASA efforts**
 - Asteroid Identification and Characterization efforts for target selection
 - Solar Electric Propulsion for transport to and return of the target asteroid
 - Robotic servicing techniques for capture
 - SLS and MPCV missions for asteroid rendezvous
- **Benefits future exploration objectives for carrying humans further into space than ever before**
 - Deep space navigation and rendezvous to enable crewed operations in deep space
 - High power solar electric propulsion to enable efficient transportation to deep space destinations
 - In space robotics for capture/control of uncooperative objects

Meeting the President's goal of sending humans to an asteroid by 2025 and Mars in the 2030s