

National Aeronautics and Space Administration

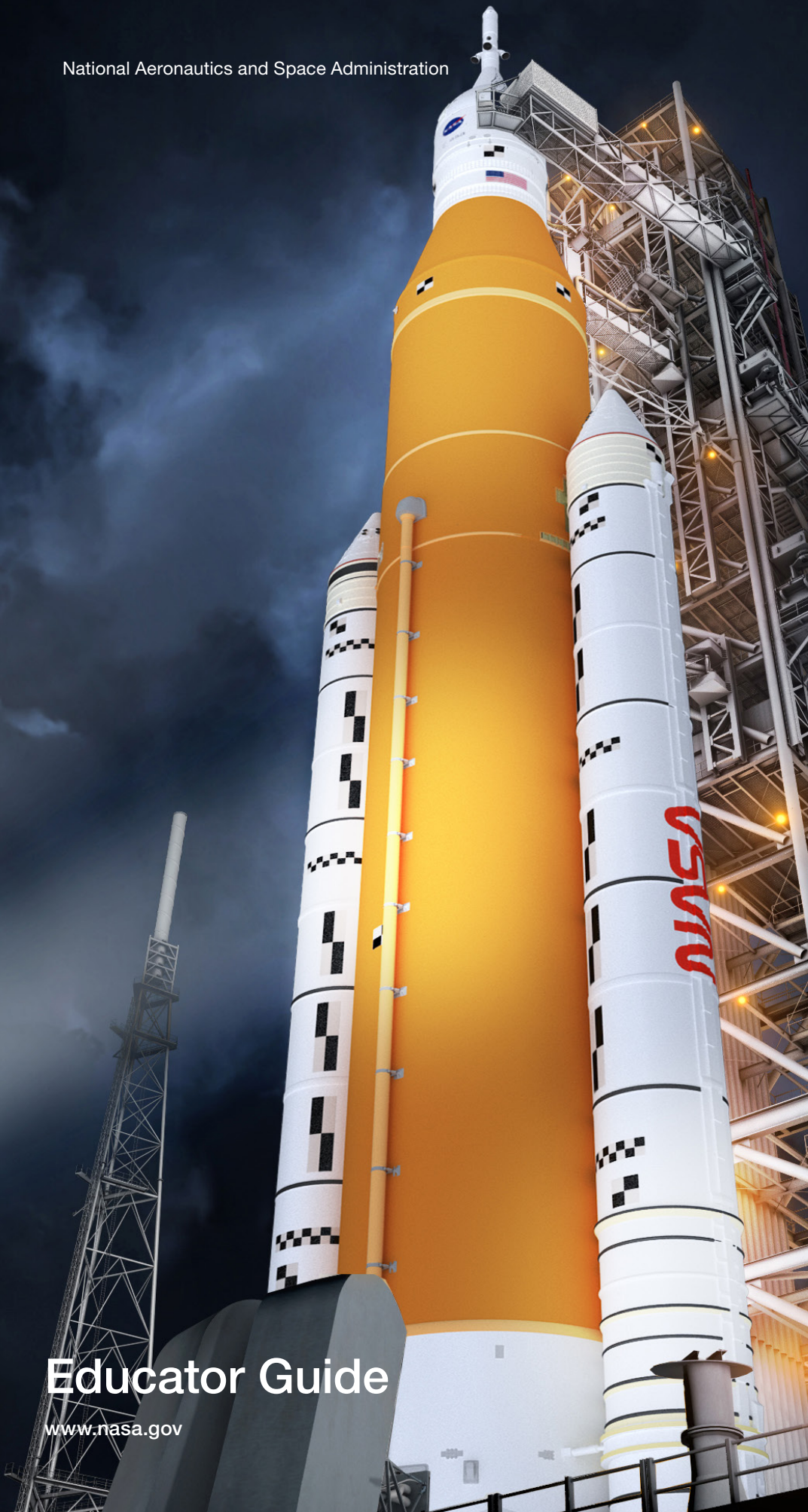

Educator Guide

[www.nasa.gov](http://www.nasa.gov)

rockets



# rocket

Pronunciation: \ră-keɪ\ noun (It rocchetta)

A vehicle, typically cylindrical, containing liquid or solid propellants which produce hot gases or ions that are ejected rearward through a nozzle and, in doing so, create an action force accompanied by an opposite and equal reaction force driving the vehicle forward. Because rockets are self-contained, they are able to operate in outer space.



# ROCKETS

Educator's Guide with Activities in  
Science, Technology, Engineering, and Mathematics.

---

# Acknowledgments

The original Rockets Teacher Guide was published by NASA's Education Division in the early-1990s. It has found widespread use in both formal and informal educational settings because of the exciting nature of the topic and because of its dynamic classroom activities that match and support both national and state education standards for science, mathematics, and technology.

This revision of the guide updates educators on NASA's Space Launch System (SLS), an advanced rocket enabling human exploration beyond low-Earth orbit. SLS will be the most powerful rocket ever built. When completed, it will enable astronauts to begin their journey to explore destinations far into the solar system. The activities in this guide have not been changed.

Many educators and scientists have contributed ideas and content directly and indirectly to this revision. Their assistance is gratefully appreciated.

## **Authors:**

Shearer Vogt and Associates, LLC  
Deborah A. Shearer, M.S.  
Gregory L. Vogt, Ed.D.

## **Editor:**

Maury Solomon

## **Graphics Support:**

Martha S. Young, B.F.A.

## **Special Thanks To:**

NASA Headquarters

Jerry G. Hartman  
Merrill King, Ph.D.

NASA Kennedy Space Center

Gregg Buckingham, Ed.D.  
Lesley Fletcher, Ph.D.  
Sharon Fegan  
Cheryl Johnson-Thornton  
Jessica Paglialonga  
James Suderman

Marshall Space Flight Center

Robert Armstrong  
Mike Crabb  
Susan Hesssler  
Twila Schneider  
Holly Snow  
Bailey Collins

Pennsylvania State University

James Gerard  
Les Gold

---

# Dear Educators:

**M**ore than 50 years have passed since the National Aeronautics and Space Administration (NASA) was created to explore the atmosphere and space. It has been an amazing time that carried humans into space and onto the Moon. Robotic spacecraft explored all of the planets and satellites gave us a new view of Earth. A giant space station was constructed, serving as a microgravity laboratory and home to astronauts from many nations. Other satellites looked out into the galaxy and beyond, almost to the beginning of time. These and other amazing events became possible because of one technology - rockets.

We stand on the edge of a new era in space exploration and rockets will take us there. Using the next generation of rockets, human presence will soon extend beyond the confines of Earth orbit. Powerful and versatile new vehicles will enable humans to return to the Moon and travel to Mars, and will open new possibilities for robotic missions to deep space destinations. The best ideas of our space exploring past are being merged with our dreams for the future. It is a wonderful time for you and your students to learn about science, technology, engineering, and mathematics. Rockets will be your vehicle for learning.

The *Rockets Educator Guide* provides you and your students many opportunities. Together, you will examine early rockets and meet thinkers and dreamers. You will learn about rocket science and mathematics and what rocket scientists do. You will see pictures of events and technologies spanning many years of space exploration - Sputnik, Apollo, and the space shuttle to name a few. You will see the future of space transportation. You will learn why rockets are the only vehicles that can “go where no one has gone before.”

Will your students be a part of this future in space? Will they be the scientists, technicians, engineers, and mathematicians that make dreams of exploring space possible? Yes! This guide will help you prepare them for the wonders that are coming.

Chapters within the guide present the history of rocketry, NASA’s Space Launch System, rocketry principles, and practical rocketry. These topics lay the foundation for what follows - a wealth of dynamic rocket science classroom activities that work. The activities focus on Sir Isaac Newton’s laws of motion and how they apply to rockets. They incorporate cooperative learning, problem solving, critical thinking, and hands-on involvement. They support national and state standards for science, mathematics, and technology across many grade levels.

All of the activities are designed with the classroom in mind. They include clear descriptions, background information for the teacher and student, detailed procedures and tips, lists of readily available materials, assessments, questions for discussion, and extensions. The activities are designed to foster excitement and a passion for learning.

The guide is versatile. It has been created as a two-to-six-week classroom unit, depending upon the grade level of the students but individual activities can be extracted and used as stand-alone classroom experiences. You will find activity objectives and principles clearly stated along with the vocabulary terms necessary for understanding the principles involved.

The goal of the *Rockets Educator Guide* is to excite young minds. Among your students are future leaders, planners, builders, explorers, settlers, and interplanetary pilots! This guide will help you lay the groundwork for their future in space.

---

# Table of Contents

Letter to Educators .....	ii
A Pictorial History of Rockets .....	1
What Comes Next .....	13
Space Launch System .....	14
Spacecraft Structures .....	18
Meet the Rocket .....	19
How Rockets Work .....	21
Applying Newton’s Laws .....	26
Rocket Activities .....	32
National Curriculum Standards .....	33
Suggested Grade Levels .....	35
Pop Can “Hero Engine” .....	36
3...2...1...PUFF! .....	42
Heavy Lifting .....	48
Newton Car .....	52
Rocket Races .....	57
Pop! Rocket Launcher .....	64
Pop! Rockets .....	67
Foam Rocket .....	73
Launch Altitude Tracker .....	81
Water Rocket Launcher .....	87
Water Rocket Construction .....	92
Project X-51 .....	96
Rocket Scientist Certificate .....	116
Careers: It Takes a Community to Explore Space .....	117
Above and Beyond – Additional Explorations .....	118
How High? .....	119
Science Fiction and the Exploration of Space .....	122
The Art of Space Flight .....	124
Rocket Glossary .....	126
NASA Resources .....	127

# A Pictorial History of Rockets

The mighty space rockets of today are the result of more than 2,000 years of invention, experimentation, and discovery. First by observation and inspiration and then by methodical research, the foundations for modern rocketry were laid.

Building upon the experience of two millennia, new rockets will expand human presence in space back to the Moon and Mars. These new rockets will be versatile. They will support Earth orbital missions, such as the International Space Station, and off-world missions millions of kilometers from home. Already, travel to the stars is possible. Robotic spacecraft are on their way into interstellar space as you read this. Someday, they will be followed by human explorers.

Often lost in the shadows of time, early rocket pioneers “pushed the envelope” by creating rocket-propelled devices for land, sea, air, and space. When the scientific principles governing motion were discovered, rockets graduated from toys and novelties to serious devices for commerce, war, travel, and research. This work led to many of the most amazing discoveries of our time.

The vignettes that follow provide a small sampling of stories from the history of rockets. They form a rocket time line that includes critical developments and interesting sidelines. In some cases, one story leads to another, and in others, the stories are interesting diversions from the path. They portray the inspirations that ultimately led to us taking our first steps into outer space. NASA’s new Space Launch System (SLS), commercial launch systems, and the rockets that follow owe much of their success to the accomplishments presented here.

# Steam, Sparks, Explosions, and Flight

## Archytas, 428 to 347 B.C.

Archytas, a Greek philosopher, mathematician, and astronomer, was said to have constructed and flown a small bird-shaped device that was propelled by a jet of steam or compressed air. The 'bird' may have been suspended by a wire or mounted at the end of a bar that revolved around some sort of pivot. This was the first reported device to use rocket propulsion.



## Hero Engine, c. A.D. 10 to 70

Though not a rocket, the main principle behind rocket (and jet) propulsion was employed in a steam engine invented by Hero of Alexandria. The exact appearance of Hero's engine is not known, but it consisted of some sort of copper vessel heated by a fire beneath. Water in the vessel turned into steam and traveled up two tubes to a hollow sphere that was free to rotate. Two L-shaped tubes from the sphere allowed the steam to escape in jets of gas. The sphere rotated rapidly in the opposite direction of the jets. The Hero engine was seen as an amusing toy, and its potential was not realized for a thousand years.



## Chinese Fire Arrows, A.D. 1232

The origins of gunpowder are not clear, but the Chinese reportedly had a rudimentary form of it in the first century. A mixture of saltpeter, sulfur, and charcoal dust produced colorful sparks and smoke when ignited. The powder was used to make fireworks. Tubes of bamboo and leather, closed at one end, were packed with gunpowder. Depending upon how the powder was packed and the size of the opening, a fountain of sparks or a bang would result when the powder was ignited. It is likely that some fireworks skittered about because of the thrust produced from the gases escaping the open end. Thus, the rocket was born. By 1232, these primitive rockets were attached to arrows and used to repel Mongol invaders in the battle of Kai-keng.



## Roger Bacon, c. 1214 to c. 1292

A monk, Bacon wrote about gunpowder in his *The Epistola Fratris R. Baconis, de secretis operibus artis et naturae et nullitate magia*: "We can, with saltpeter and other substances, compose artificially a fire that can be launched over long distances....By only using a very small quantity of this material much light can be created accompanied by a horrible fracas. It is possible with it to destroy a town or an army...." Bacon is thought to have developed improved gunpowder formulas that greatly increased the mixture's power.

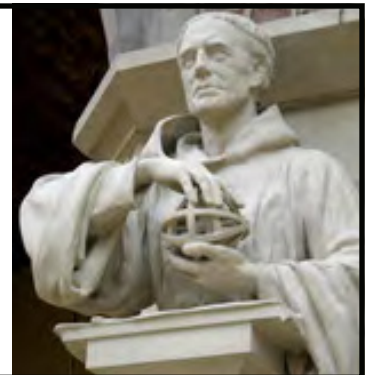



### Wan Hu, Sixteenth Century

According to legend Wan Hu, a Chinese stargazer and local official living sometime around the middle of the Ming dynasty, dreamed of spaceflight. He constructed a chair and attached 47 gunpowder rockets to its base. In some versions of the story, his chair also had kite wings. On launch day, 47 assistants rushed up and simultaneously lit the fuses of all the rockets. A huge explosion followed. When the smoke cleared, Wan Hu was gone. Some have suggested Wan Hu actually made it into space, and you can see him as the “Man in the Moon.” Regardless of the actual end, Wan Hu had the right idea—use rockets to travel into space.



### Rockets Go to War

For centuries to come, rockets competed with cannons as the weapon of choice for war. Each technological development moved one or the other system into or out of favor. Cannons were more accurate. Rockets could be fired more quickly. Breech-loading cannons speeded up the firing. Rocket fins increased accuracy. Cannons had greater range. Rockets had greater range. And so on. Invention abounded. Invented by Joanes de Fontana of Italy (1420), a surface-running rocket torpedo was supposed to set enemy ships on fire.

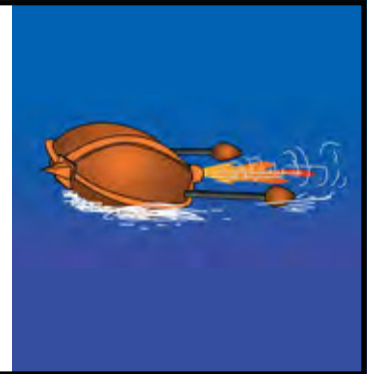

### Kazimierz Siemienowicz, c. 1600 to c. 1651

Kazimierz Siemienowicz, a Polish-Lithuanian commander in the Polish Royal Artillery, was an expert in the fields of artillery and rocketry. He wrote a manuscript on rocketry that was partially published before his death. In *Artis Magnae Artilleriae pars prima*, he published a design for multistage rockets that was to become a fundamental rocket technology for rockets heading for outer space. Siemienowicz also proposed batteries for military rocket launching and delta-wing stabilizers to replace the guiding rods currently in use with military rockets. It was rumored that Siemienowicz was killed by members of guilds that were opposed to him publishing their secrets, and they hid or destroyed the remaining parts of his manuscript.



## The Birth of Rocket Science

### Galileo Galilei, 1564 to 1642

In addition to his many other accomplishments, this Italian astronomer and mathematician rekindled the spirit of scientific experimentation and challenged old beliefs relating to mass and gravity. He proved that an object in motion does not need the continuous application of force to keep moving. He called this property of matter, which causes it to resist changes in velocity, “inertia.” Inertia is one of the fundamental properties that Isaac Newton would later incorporate into his laws of motion.

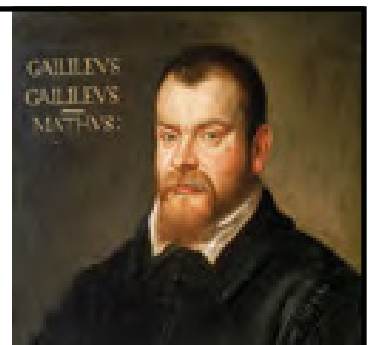

### **Newton's Laws of Motion, 1642 to 1727**

English scientist Sir Isaac Newton condensed all rocket science into three elegant scientific laws. Published in *Philosophiæ Naturalis Principia Mathematica* his laws, previously understood intuitively by early rocketeers, provided the foundation for all modern rocket science. (The “Rocket Principles” chapter focuses on these laws and the “Practical Rocketry” chapter demonstrates the applications of these laws.)



### **Colonel William Congreve, 1772 to 1828**

Following stunning rocket barrages against the British by the forces of Tippoo Sultaun of India, William Congreve took charge of British military rocket companies. Some of his designs had operational ranges of 6,000 yards. He created both case-shot rockets that sprayed the enemy with carbine balls and incendiary rockets for burning ships and buildings. He invented launching rockets from ships. The phrase “by the rocket’s red glare,” coined by Francis Scott Key during the War of 1812, referred to British-launched Congreve rockets.

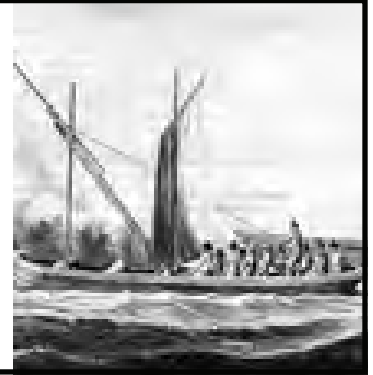

### **Jules Verne, 1828 to 1905**

The dream of traveling through space was brought to life by French science fiction writer Jules Verne. In his *De la Terre à la Lune*, Verne used a giant cannon to fire a manned projectile at the Moon. Although not a rocket, the projectile had some interesting parallels with the future Apollo Moon program. It was called the Columbiad and contained a crew of three. It was fired at the Moon from Florida. The Apollo 11 capsule was named Columbia, contained a crew of three, and was launched from Florida. Verne correctly described how the crew would feel “weightless” on their voyage. Of course, the crew would not have survived the initial acceleration of the cannon firing. Nevertheless, Verne, an early space exploration visionary, fired the imaginations of many would-be rocketeers and future astronauts.



## **Modern Rocket Pioneers**

### **Konstantin E. Tsiolkovsky, 1857 to 1935**

Konstantin Tsiolkovsky was a teacher, theorist, and astronautics pioneer. Son of a Polish forester who emigrated to Russia, he wrote and taught extensively about human space travel and is considered the father of cosmonautics and human spaceflight. Tsiolkovsky advocated liquid propellant rocket engines, orbital space stations, solar energy, and colonization of the solar system. His most famous work, “*Research into Interplanetary Space by Means of Rocket Power*,” was published in 1903, the same year the Wright brothers achieved powered and controlled airplane flight. His rocket equation, based on Newton’s second law of motion, relates rocket engine exhaust velocity to the change in velocity of the vehicle itself.



### **Robert H. Goddard, 1882 to 1945**

American college professor and scientist Robert Goddard built and flew the world's first liquid propellant rocket on March 16, 1926. Its flight, though unimpressive (it climbed only 12.5 meters), was the forerunner of the Saturn V Moon rocket 43 years later. At the request of local townsfolk, Goddard moved his experiments from Auburn, Massachusetts, to the deserts around Roswell, New Mexico. There he continued his experiments and developed a gyroscope system to control his rockets in flight, instrumentation payload compartments, and parachute recovery systems. He is often referred to as the "father of modern rocketry."



### **Hermann Oberth, 1894 to 1989**

Hermann Oberth, a Romanian by birth and a naturalized German citizen, became fascinated by the works of Jules Verne and devoted his life to promoting space travel. His dissertation for the University of Heidelberg, rejected for being too speculative, became the basis for his book *Die Rakete zu den Planetenraumen* (By Rocket to Space). The book explained the mathematics of spaceflight and proposed practical rocket designs and space stations. This and other books inspired a generation of rocketeers. Rocket societies sprang up around the world, including the German Verein für Raumschiffahrt (Society for Space Travel) that led to the development of the V2 rocket.



### **Rocket Experimenters, Early Twentieth Century**

In the 1920s and 1930s, leading up to World War II, amateur rocketeers and scientists worldwide attempted to use rockets on airplanes, racing cars, boats, bicycles with wings, throw lines for rescuing sailors from sinking ships, mail delivery vehicles for off-shore islands, and anything else they could dream up. Though there were many failures, experience taught the experimenters how to make their rockets more powerful and more reliable.



## **World War II**

### **Flying Bombs**

The necessities of war led to massive technological improvements in aeronautics and rocketry. Almost overnight, rockets graduated from novelties and dream flying machines to sophisticated weapons of destruction. Rockets propelled nearly unstoppable German fighter planes and Japanese Kamikaze pilots with bombs into ships. War would never be the same again.



## Vergeltungswaffe 2 - V2

In the late 1930s, the German Verein für Raumschiffahrt (Society for Space Travel) evolved into the team that built and flew the most advanced rocket for the time, the V2. On the shores of the Baltic Sea, the team, under the directorship of Wernher von Braun, created a rocket powered by alcohol and liquid oxygen. With a range of 200 miles and a maximum altitude of 55 miles, the V2 could deliver a 1-ton explosive warhead to the heart of London without warning. Thousands of V2s were built, but they entered the war too late to affect the outcome.



## The Space Age Begins

### Bumper Project

At the conclusion of the war in Europe, 300 trainloads of V2 rockets and parts were captured and shipped to the United States along with the majority of the principal designers, who decided beforehand to surrender to American troops. The V2 became the basis of the intercontinental ballistic missile development program and led directly to the manned space program. Employing one of the captured V2 rockets with a WAC Corporal rocket (named for the Women's Army Corps) at its top, the initial launch of a "Bumper-WAC" took place on May 13, 1948. During six flights, the largest two-stage rocket launched to date in the United States eventually reached an altitude of almost 400 kilometers (250 miles).



### The World's First Artificial Satellite

At the conclusion of World War II, the United States and the Soviet Union engaged in a race for space. The Soviet Union won the first round by launching its Sputnik I satellite on October 4, 1957. The satellite had a spherical design with four antenna. It weighed 83.6 kilograms (184.3 pounds). Two months later, the 508.3-kilogram (1,118.26-pound) Sputnik II reached space with a living passenger. Laika, a small dog, orbited Earth for a few hours. Although she died in space, she led the way for all humans that followed.



### Explorer 1

The United States entered the satellite-launching business on January 31, 1958 with the successful launch of Explorer 1. The satellite was launched atop the Juno 1, a modified Jupiter-C booster. Though much smaller than the Sputniks, only 13.93 kilograms (30.66 pounds)—Explorer 1's Geiger counter made the first important discovery about the space environment. Explorer 1 detected around Earth what would later be called the Van Allen Radiation Belts.



## **X-15**

Between 1959 and 1968, America's X-15 experimental aircraft flew to the edge of space. In 199 flights, the air-launched rocket plane broke many flight records, including speed (7,274 kph or 4,520 mph) and altitude records (108 kilometers or 67 miles). Test flights established important parameters for attitude control in space and re-entry angles. Neil Armstrong, the first American to step on the Moon, was one of twelve X-15 pilots.



## **Yuri Gagarin Goes Into Orbit**

On April 12, 1961, space became the domain of humans with the launch of cosmonaut Yuri Gagarin. His spaceflight lasted 1 hour and 48 minutes. During that time, Gagarin orbited Earth one time inside his Vostok 1 space capsule, reaching a maximum altitude of 315 kilometers (196 miles). Upon re-entry, Gagarin ejected himself from the capsule at an altitude of 6,100 meters (20,000 feet) and parachuted safely to the ground.



## **Freedom 7**

On May 5, 1961, American astronaut Alan Shepard, Jr., lifted off from Cape Canaveral, Florida, inside his Freedom 7 Mercury space capsule, which sat atop a Redstone rocket. The rocket did not have enough power to send the craft into orbit, and Shepard made a suborbital flight reaching 187 kilometers (116 miles) before his capsule returned to Earth in an ocean splashdown 15 minutes 22 seconds later.



## **Moon Rocket**

Just days after Alan Shepard's flight, President John F. Kennedy addressed a joint session of Congress and challenged America to send an American to the Moon and return him safely before the end of the decade. Although it was a shockingly bold announcement, some of the steps to accomplish this mission were already underway. NASA had begun work on components of a rocket capable of a round trip lunar flight. By the next year, the rocket was named the Saturn V. It would be 110.6 meters or 363 feet tall, dwarfing all previous rockets. The Saturn V would consist of three stages, a capsule with a small propulsion unit for the return trip, and a two-stage lunar lander.



## Glenn Orbits Earth

On February 20, 1962, riding on a more powerful missile, the Atlas, astronaut John H. Glenn, Jr., became the first American to go into orbit. Glenn's flight achieved parity with the Soviet program. Glenn orbited Earth three times for a total of 4 hours and 55 minutes in space. A sensor switch led to an early return. The sensor indicated that the Mercury capsule heat shield was loose, but the shield was later determined to be firmly in place during flight. The sensor was faulty. The last of the six Mercury flights took place on May 15, 1963, with astronaut Gordon Cooper remaining in space for nearly a day and a half.



## Preparing for the Moon

Project Gemini followed the Mercury missions. The Gemini space capsule, riding on top of a Titan missile, contained two astronauts. During missions lasting up to 14 days, Gemini astronauts pioneered spacewalking, spacecraft rendezvous, and docking procedures. Important spacecraft systems, needed for the coming Moon flights, were evaluated. Ten Gemini missions were flown during 1965 and 1966. The Titan rocket, initially created as an intercontinental ballistic missile, went on to carry the Viking spacecraft to Mars and the Voyager spacecraft to the outer solar system in the 1970s.



## Dr. Wernher von Braun

One of the leading figures in the development of pre-war Germany's rocket program and the development of the V2 missile, von Braun (1912-1977) became a leading proponent of America's space program. He entered the United States after the war and became a naturalized citizen. He worked on the development of intercontinental ballistic missiles and led the development team that launched Explorer 1. Dr. von Braun was the chief architect and engineer of the Saturn V Moon rocket. His popular writings and collaboration with Disney on a "Tomorrowland" TV series did much to inspire the next generation of rocket scientists and astronauts.



## Gene Roddenberry

Gene Roddenberry (1921-1991), a distinguished World War II bomber pilot and commercial pilot, began his writing career penning stories about flying. He began writing for television and developed a concept for a "western" series set among the stars. For three years (1966-1968), the Star Trek series explored a wide range of scientific and social issues as humans traveled across the galaxy. The series became so popular that the first space shuttle orbiter test vehicle was named Enterprise after the star ship Enterprise. The original show spawned several companion series and a string of movies. Roddenberry, a visionary, inspired a generation of space travelers.



### “One Small Step...”

At 10:56 p.m. EDT, July 20, 1969, American astronaut Neil Armstrong set foot on the Moon. It was the first time in history that humans had touched another world. He was followed to the surface by Edwin “Buzz” Aldrin, Jr. A third astronaut, Michael Collins, remained in lunar orbit in the Apollo capsule. The Apollo 11 mission was the first of six Moon landings extending to the end of 1972. The astronauts’ spacecraft, the lunar module, consisted of descent and ascent stages. The descent stage had four legs and a powerful rocket engine to slow the craft for landing on the Moon. After surface explorations, the upper part of the lander lifted off, using its own rocket engine, and rendezvoused with the Apollo capsule for the return to Earth.



### Skylab

Using a modified third stage of the Saturn V rocket, the United States launched its first space station, called Skylab, into Earth orbit in 1973. Rather than engines and fuel tanks, the interior of the third stage was fitted with living quarters and laboratories for three astronauts for extended stays in space. Solar panels provided electric power. Due to a problem during launch, one of the large panels was lost. Nevertheless, three crews of astronauts called Skylab home until 1974. The last crew remained in space 84 days.



### Smaller Saturn

The Saturn V rocket was capable of launching 117,900 kilograms (260,000 pounds) into low-Earth orbit and 40,800 kilograms (90,000 pounds) to the Moon. For some Apollo missions, though, a smaller Saturn was called for. The Saturn IB was 68 meters (224 feet) tall and required a scaffold platform nicknamed the “milk stool” to be placed on the pad designed for Saturn V rockets. This enabled the Saturn IB to match up with swing arms from the launch structure. The Saturn IB carried some of the early Apollo test missions, the three crews for Skylab, and the American crew for the 1975 historic Apollo-Soyuz mission, linking astronauts and cosmonauts in orbit.



## Orbits and Probes

### Deep Space

The Titan rockets (1959–2005), used for launching the Gemini missions, found wide use in launching unmanned payloads. Upgraded versions of Titans lofted heavy satellites into Earth orbit and propelled important spacecraft to other planets. The Viking missions to Mars and the Voyager missions to the outer planets and interstellar space are among its credits.



## Sounding Rockets

Although rockets have generally gotten larger and more powerful, there are many reasons for flying smaller rockets. The Canadian – designed Black Brant sounding rocket has been flying since 1961 and has successfully completed over 800 flights carrying small payloads such as cameras, instruments, and microgravity experiments. The Black Brant’s reliability and low cost has made it a favorite of researchers. The biggest multistage Black Brants have payload capacities of about 100 kilograms (220 pounds) and can reach altitudes of up to 900 kilometers (560 miles).



## Delta Family

With roots going back to the early 1960s, the American Delta rocket is one of the most versatile of the commercial and military payload launch rockets. Delta has many configurations, including multiple stages and heavy-lift strap-on boosters that increase payload capacity to high orbits. The Delta family has logged more than 325 launches, with a success rate exceeding 95 percent.

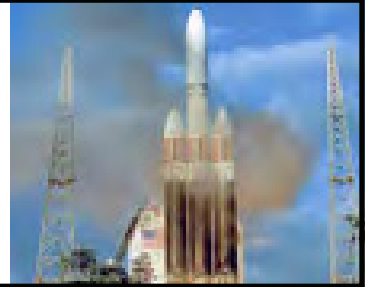

## Atlas

Like the Delta rocket, the Atlas has deep roots. Now in its fifth major configuration, the Atlas was created as a missile in the 1950s. It was adapted to carry John Glenn and three other Mercury astronauts to space and has since been used for many commercial, scientific, and military satellite launches and interplanetary missions. The Atlas V rocket (shown) is the latest in the series.



## Pegasus

Like the mythological creature, the Pegasus launch vehicle is winged. Lifted to about 12,000 meters it is then air-launched from under the wing of a carrier aircraft. This arrangement keeps launch costs low for small orbital payloads.



## Thirty Years

The space shuttle was a new concept for carrying crews and payloads into low-Earth orbit. It consisted of a central external tank surrounded by two solid rocket boosters and a winged orbiter. Only the orbiter, a spacecraft/airplane/space truck, actually reached orbit. It was designed to be reusable as were the solid rocket boosters. A new external tank was needed for each mission. Inside a cavernous payload bay were science laboratories, space probes, telescopes, or Earth-sensing systems. Many shuttle payloads consisted of components for the International Space Station. At the end of a shuttle mission, the orbiter reentered Earth’s atmosphere and glided to an unpowered landing on a runway. The first space shuttle flight took place in 1981 and the last of its 135 missions concluded in 2011.

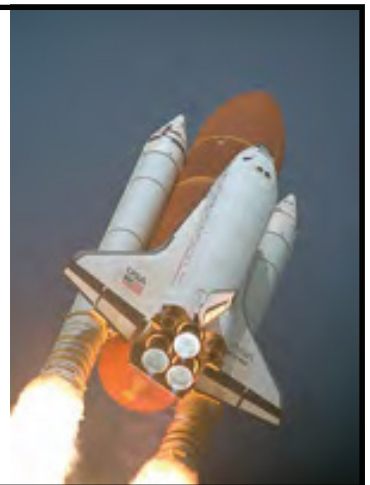



# The Space Launch System and a New Era of Commercial Space Flight

## The Space Launch System

NASA's Space Launch System, or SLS, will be the most powerful rocket ever built. It is an advanced launch vehicle for a new era of human exploration beyond Earth's orbit. With its unprecedented power and capabilities, SLS is the only rocket that can send Orion, astronauts, and large payloads to the Moon on a single mission. Artemis I, an uncrewed flight test, will be the first integrated test of NASA's deep space exploration systems: the Orion spacecraft, SLS rocket, and the ground systems at Kennedy Space Center in Cape Canaveral, Florida.



## The Dragon and the Falcon

The Dragon is the first orbital spacecraft launched and recovered by a private company. As one of several private endeavors under NASA's Commercial Orbital Transportation Services program, Dragon was developed by Space Exploration Technologies, or SpaceX. It is an autonomous spacecraft that will deliver to and return payloads and crew from the International Space Station. It will ride on Falcon rockets also built by SpaceX. The Falcon is a family of rockets to meet different mission requirements. The Falcon Heavy has the ability to lift 64,000 kilograms to low-Earth orbit, making it the most powerful U.S. rocket after NASA's SLS rocket.



## Dream Chaser

Sierra Nevada Corporation's Dream Chaser was selected by NASA to provide cargo delivery, return, and disposal service for the International Space Station under the Commercial Resupply Services 2 (CRS-2) contract. Dream Chaser Tenacity will be the first orbital vehicle in the Dream Chaser spaceplane fleet. Dream Chaser will provide a minimum of six cargo missions to and from the space station carrying critical supplies like food, water, and science experiments.



## Space Tourism

In 2004, SpaceShipOne successfully flew three missions to become the first privately developed space vehicle to carry a pilot above 100 kilometers (62.5 miles). Built by Burt Rutan and financed by Microsoft co-founder Paul Allen, it won the \$10 million Ansari X Prize. Using the next generation version, SpaceShipTwo, Virgin Galactic will offer suborbital flights to tourists and researchers. SpaceShipTwo flights will originate from Spaceport America in New Mexico. Soon, spaceflight will belong to all.

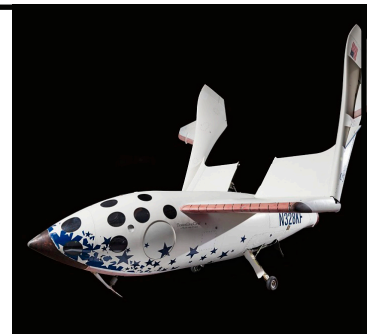

# And Beyond?

Beginning more than 2,000 years ago, rockets evolved from toys into complex machines capable of amazing flights. Rockets are still the only means of travel to and through space. Their evolution depended upon discovery, necessity, and experimentation. The development of rockets did not move in a straight line. Ideas and experiments founded only in fantasy and not in science and mathematics often failed, but rocketeers gradually learned. Spurring them on were dreamers and doers like Jules Verne, Konstantin Tsiolkovsky, Robert Goddard, Gene Roddenberry, and Neil Armstrong. They plotted the course to the future through words, inventions, and accomplishments.

“Those three men,” said he, “have carried into space all the resources of art, science, and industry. With that, one can do anything....”

Jules Verne’s, “From Earth to the Moon.”

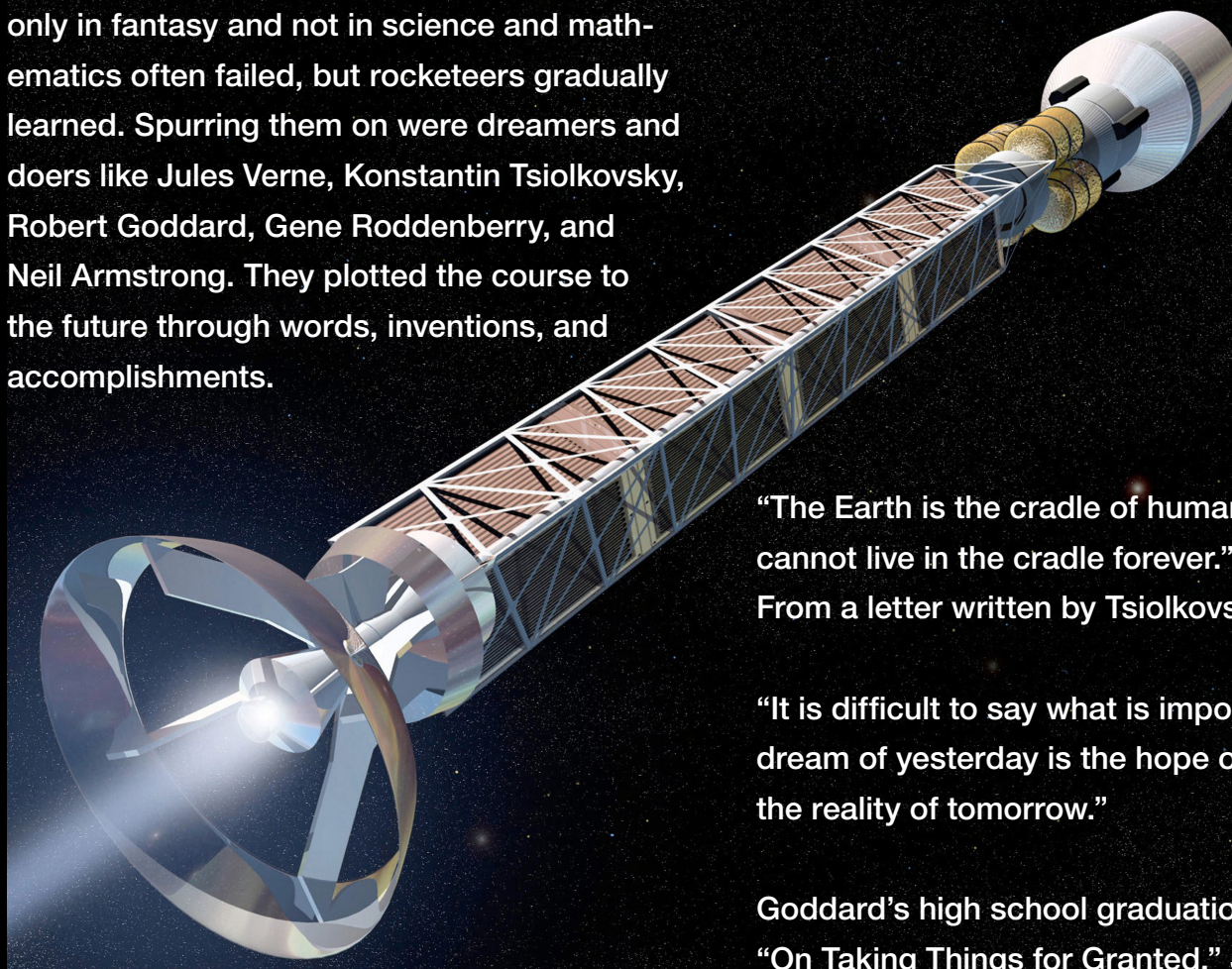

“The Earth is the cradle of humanity, but one cannot live in the cradle forever.”

From a letter written by Tsiolkovsky, in 1911.

“It is difficult to say what is impossible, for the dream of yesterday is the hope of today and the reality of tomorrow.”

Goddard’s high school graduation oration, “On Taking Things for Granted,” June 1904.

“...to seek out new life, new civilizations. To boldly go where no man has gone before.

”Star Trek television series opening theme.“

That’s one step for (a) man; one giant leap for mankind.”Neil Armstrong on the Moon.

Who will be the dreamers and doers of tomorrow? Where will they take us?

# What Comes Next

An entire generation grew up with the space shuttle. Under development for most of the 1970s, the space shuttle Columbia made its maiden flight on April 12, 1981. By the time of its retirement in 2011, the space shuttle flew 135 missions and carried more astronauts into space than all other rockets combined. It deployed satellites, sent space probes throughout the solar system, and carried science laboratories and many of the major components of the ISS. The space shuttle was a complex and versatile space launch system and its flights ended when the ISS was fully assembled. What comes next? In the decades of exploration that followed its creation in 1958, NASA expanded our perspective of the universe and humanity's place within it. Many important lessons have been learned, some of them the hard way. It is now time to advance our ability to travel and live in space. Once again, NASA will forge a new era of space exploration.

## NASA'S Vision

**We reach for new heights and reveal the unknown for the benefit of humankind**

In a few years, space travelers will embark on a wide range of space missions near Earth and into the solar system. A new NASA rocket will take them there. NASA's new SLS rocket will take them there, in the process joining a family of new rockets, some developed by private industry for commercial space transportation involving cargo, astronauts, and tourists. Space will no longer be just the realm of highly trained astronauts.

Yet NASA's SLS rocket is the most ambitious effort of them all. A modular heavy-lift vehicle that can be configured in different ways for different missions, the SLS rocket will carry astronauts into orbit, as well as massive payloads destined for distant places. It will be tested during a series of launches with the first being an uncrewed flight to the vicinity of the Moon called Artemis I. Then an advanced SLS will take flight, thanks to the best ideas and technology of the past, present, and future.

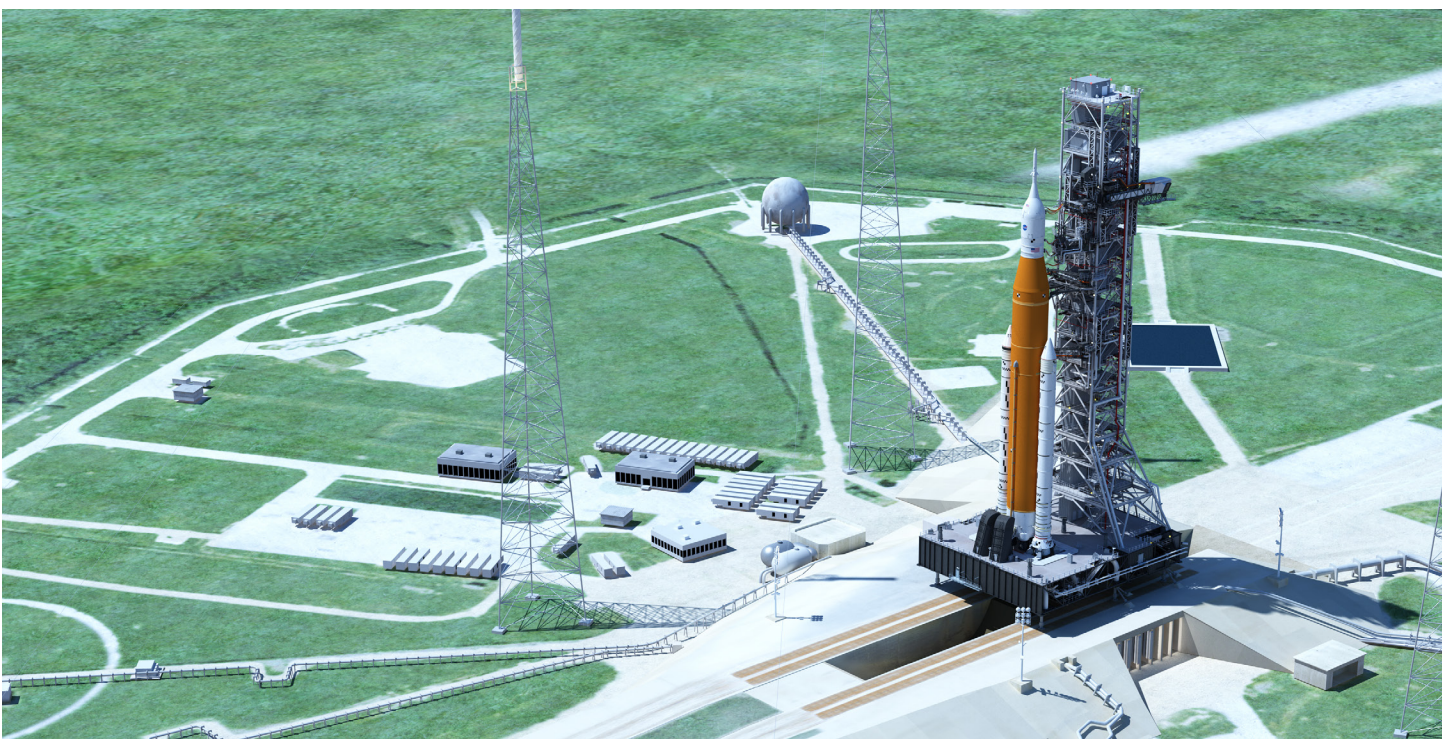

NASA's SLS rocket will stand 322 feet (ft.) [98 meters (m)] tall. It will launch from Kennedy Space Center's Launch Pad 39B.

## Space Launch System

### America's Rocket for Deep Space Exploration

NASA's Space Launch System, or SLS, is an advanced launch vehicle that provides the foundation for human exploration beyond Earth's orbit. With its unprecedented power and capabilities, SLS is the only rocket that can send Orion, astronauts, and large cargo to the Moon on a single mission.

Offering more payload mass, volume capability, and energy to speed missions through space than any current launch vehicle, SLS is designed to be flexible and evolvable and will open new possibilities for payloads, including robotic scientific missions to places like the Moon, Mars, Saturn, and Jupiter.

### The Power to Explore Beyond Earth's Orbit

To fulfill America's future needs for deep space missions, SLS will evolve into increasingly more powerful configurations. SLS is designed for deep space missions and will send Orion or other cargo to the Moon, which is nearly 1,000 times farther than where the space station resides in low-Earth orbit. The rocket will provide the power to help Orion reach a speed of at least 24,500 mph [39,425 kph] needed to break out of low-Earth orbit and travel to the Moon. That is about 7,000 mph (11,265 kph) faster than the space station travels around Earth.

Every SLS configuration uses the core stage with four RS-25 engines. The first SLS vehicle, called Block 1, can send more than 59,000 pounds (lbs.) [27 metric tons (t) (59,000 lbs.)] to the Moon's vicinity. It will be powered by twin five-segment solid rocket boosters and four RS-25 liquid propellant engines generating 8.8 million lbs. [39,144 kilonewton (kN)] of thrust.

After reaching space, the interim cryogenic propulsion stage (ICPS) sends Orion on to the Moon.

The next planned evolution of the SLS, the Block 1B crew vehicle, will use a new, more powerful Exploration Upper Stage (EUS) to enable more ambitious missions. The Block 1B vehicle can, in a single launch, carry the Orion crew vehicle along with exploration systems like a deep space habitat module.

The Block 1B crew vehicle can send approximately 38 t (83,700 lbs.) to deep space including Orion and its crew. Launching with cargo only, SLS has a large volume payload fairing to send larger exploration systems or science spacecraft on solar system exploration missions.

The next SLS configuration, Block 2, will provide 9.5 million lbs. (42,258 kN) of thrust. It will be the most powerful variant and will be used for carrying large payloads to the Moon, Mars, and other deep space destinations. SLS Block 2 crew will be designed to lift more than 43 t (94,700 lbs.) to deep space. The design for SLS Block 2 cargo will allow for over 46 t (101,400 lbs.) to be lifted into deep space. An evolvable design provides the nation with a rocket able to pioneer new human spaceflight missions.

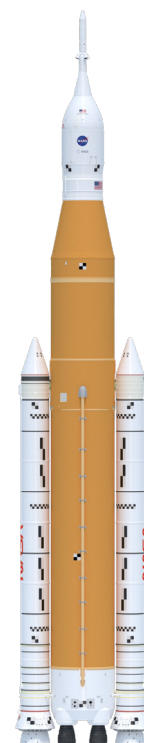

SLS Block 1

## Block 1 - Initial SLS Configuration

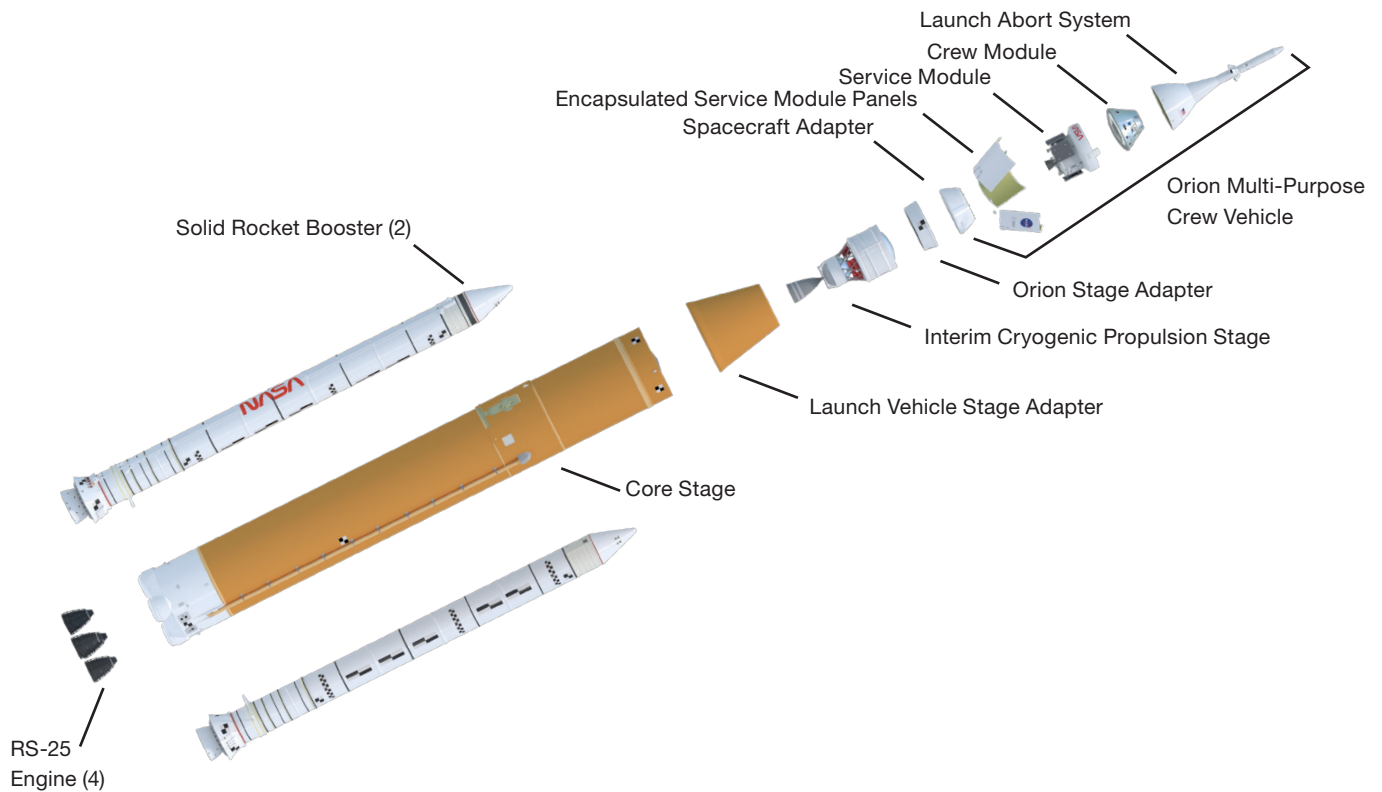

## Space Launch System Missions

Artemis I, the first integrated flight of SLS and Orion, uses the Block 1 configuration, which stands 322 feet (ft.) [98 m], taller than the Statue of Liberty, and weighs 5.75 million lbs. [2.6 million kg]. SLS will produce 8.8 million lbs. (39,144 kN) of maximum thrust, 15 percent more thrust than the Saturn V rocket.

For Artemis I, Block 1 will launch an uncrewed Orion spacecraft to an orbit 40,000 miles [64,374 kilometers (km)] beyond the Moon, or 280,000 miles [450,616 km] from Earth. This mission will demonstrate the integrated system performance of SLS, Orion, and Exploration Ground Systems teams prior to a crewed flight to send Orion to lunar orbit. SLS will also carry 13 small satellites, each about the size of a shoebox, to be deployed in deep space.

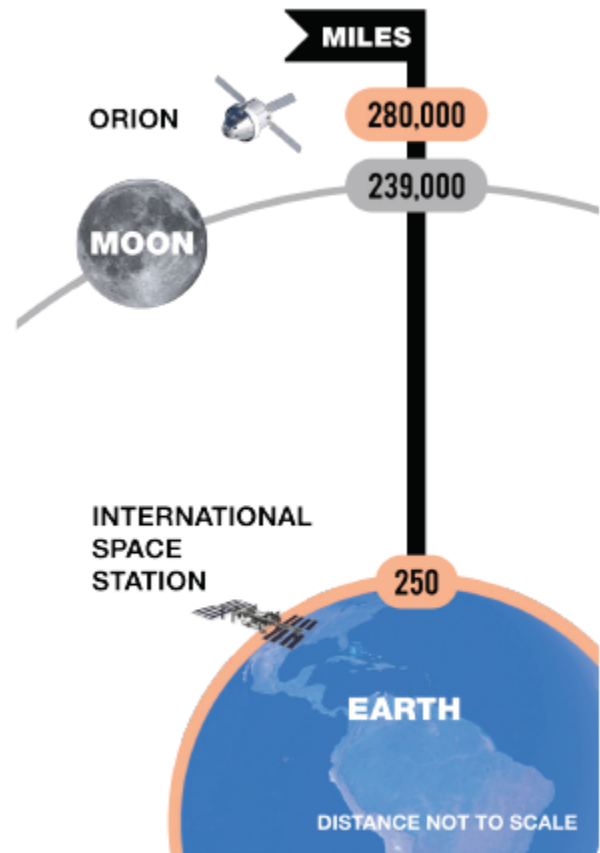

NASA's Space Launch System is powerful enough to send the Orion spacecraft beyond the Moon. For Artemis I, Orion will travel 280,000 miles from Earth—farther in deep space than any spacecraft built for humans has ever ventured.

## Core Stage

The Boeing Company, in Huntsville, Alabama, is building the SLS core stage, including the avionics that will control the vehicle during flight. Towering more than 212 ft. (64.6 m) with a diameter of 27.6 ft. (8.4 m), the core stage will store 733,000 gallons (2.77 million liters) of super-cooled liquid hydrogen and liquid oxygen that will fuel the RS-25 engines.

The core stage is being built at NASA's Michoud Assembly Facility in New Orleans using state-of-the-art manufacturing equipment, including a self-reacting friction-stir-welding tool that is the largest of its kind in the world. The SLS avionics computer software is being developed at NASA's Marshall Space Flight Center in Huntsville.



SLS core stage liquid oxygen tank (top) and liquid hydrogen tank (bottom).

## RS-25 Engines

Propulsion for the SLS core stage will be provided by four RS-25 engines. Aerojet Rocketdyne of Sacramento, California, is upgrading an inventory of 16 RS-25 shuttle engines to SLS performance requirements, including a new engine controller, nozzle insulation, and required operation at 512,000 lbs. (2,277 kN) of thrust. During the flight, the four engines provide around 2 million lbs. (8,896 kN) of thrust.

Following the installation of the engines into the fully assembled Artemis I core stage, NASA's Pegasus barge transported the entire stage to Stennis Space Center near Bay St. Louis, Mississippi, for testing. Once testing is complete, Pegasus will take the core stage to Kennedy Space Center in Florida where it will be prepared for launch. Aerojet Rocketdyne has started development testing of new, advanced components to make the engines more affordable and powerful for future missions.



The four RS-25 engines that will power SLS for its first flight.

## Boosters

Two shuttle-derived solid rocket boosters will be used for the initial flights of the SLS. To provide the additional power needed for the rocket, the prime contractor for the boosters, Northrop Grumman, of Redondo Beach, California, has modified the original shuttle's configuration of four propellant segments to a five-segment version. The design includes new avionics, propellant design, and case insulation, as well as eliminates the recovery parachutes.

Northrop Grumman has delivered the boosters for Artemis I to Kennedy Space Center. They were carried by train from their facility in Promontory, Utah, and will be stacked with other components. The SLS twin boosters provide more than 75 percent of the total SLS thrust at launch.



Artemis I booster aft segment.

## RS-25 Engines

The Orion stage adapter will connect Orion to the interim cryogenic propulsion stage (ICPS) on the SLS Block 1 vehicle and is the place where the small satellites will ride to space. Teledyne Brown Engineering of Huntsville, Alabama, has built the launch vehicle stage adapter (LVSA) that will connect SLS's core stage to the upper part of the rocket.

The initial capability to propel Orion out of Earth's orbit for Block 1 will come from the ICPS, based on the Delta Cryogenic Second Stage used successfully on United Launch Alliance's Delta IV family of rockets. It uses one RL10 engine made by Aerojet Rocketdyne. The engine is powered by liquid hydrogen and liquid oxygen and generates 24,750 lbs. (110 kN) of thrust.

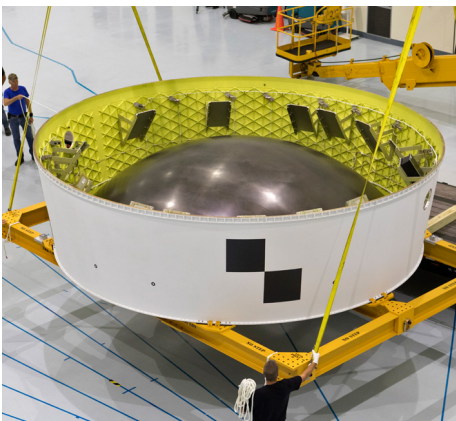

Orion stage adapter.



Launch vehicle stage adapter.



Interim cryogenic propulsion stage.

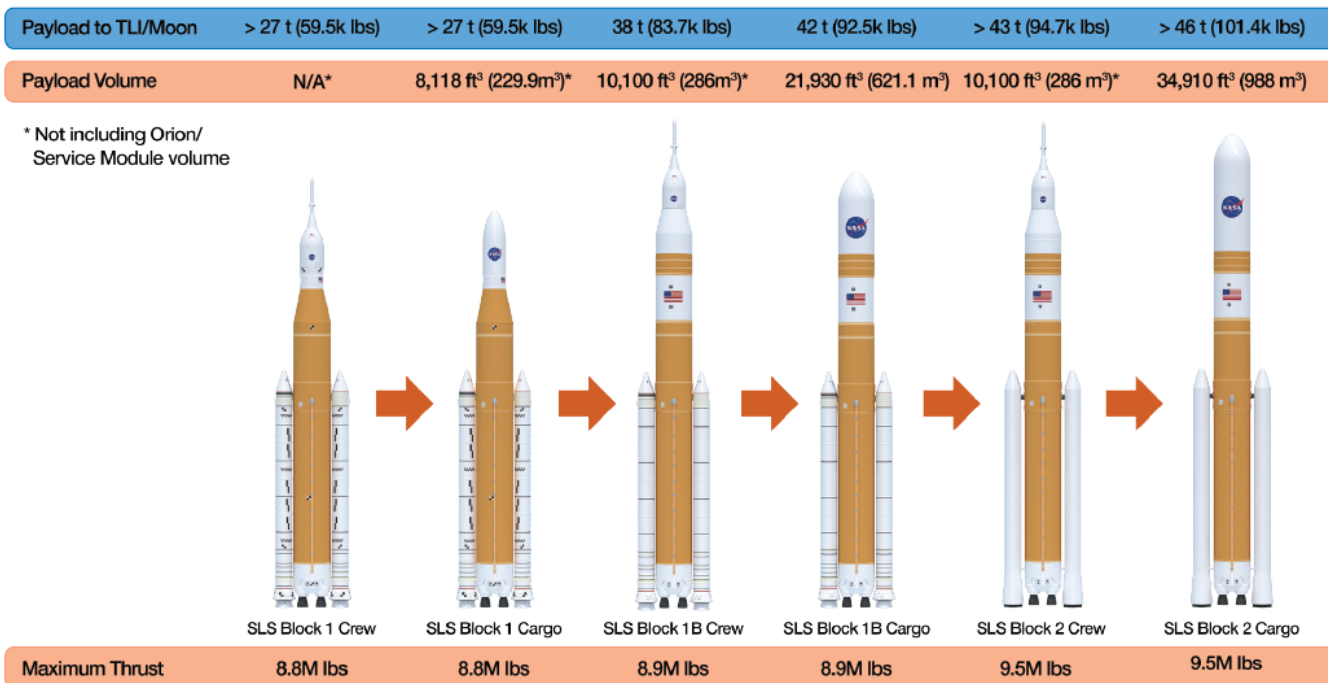

## SLS Evolution

NASA has designed the Space Launch System as the foundation for a generation of human exploration missions to deep space, including missions to the Moon and Mars. SLS will leave low-Earth orbit and send the Orion spacecraft,

its astronaut crew, and cargo to deep space. To do this, SLS has to have enough power to perform a maneuver known as trans-lunar injection, or TLI. This maneuver accelerates the spacecraft from its orbit around Earth onto a trajectory toward the Moon. The ability to send more mass to the Moon on a single mission makes exploration simpler and safer.

## Spacecraft Structures

Every pound that is carried to space requires fuel, whether that pound is cargo, crew, fuel, or part of the spacecraft itself. The more the vehicle and fuel weigh, the fewer passengers and smaller payload the vehicle can carry. Designers try to keep all the parts of the vehicle, including the skeleton (or structure), as light as possible. To design a lightweight structure is very difficult because it must be strong enough to withstand the tremendous thrust (or force) of the engines during liftoff. Throughout the history of space vehicles, engineers have used various strategies for the structure.

In order to make the SLS spacecraft as light as possible, NASA engineers are constructing

it with lightweight, strong materials, such as aluminum alloys and composites. NASA engineers also design structures that use as little material as possible to achieve the strength and rigidity they need. So, for example, they machine a waffle grid pattern into the inside of the core stage panels to keep them rigid with minimum weight.

This engineering design challenge focuses on the thrust structure, which attaches the four liquid fuel engines to the body of the rocket. The thrust structure is an essential part of the spacecraft, which must be kept lightweight. As they burn, the four RS-25 engines on the SLS produce about 2 million lbs. (8,896 kN) of thrust. The thrust structure must not only withstand this force, it must transfer it to the vehicle in a balanced way, without damaging the vehicle.





# M E E T T H E R O C K E T

If you wonder how NASA's Space Launch System, or SLS, compares to earlier generations of NASA launch vehicles:

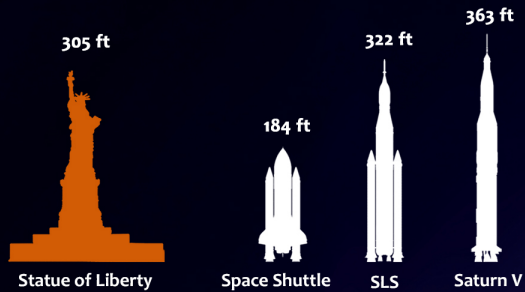

SLS will produce 13% more thrust at launch than the space shuttle and 15% more than Saturn V during liftoff and ascent.

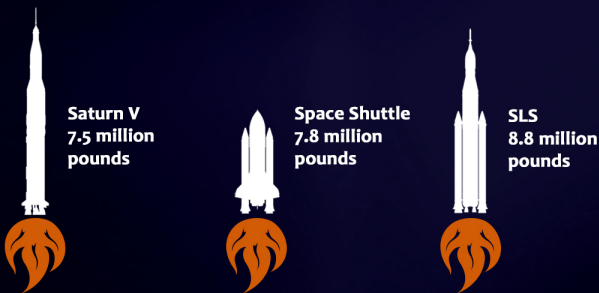

SLS will launch more cargo to the Moon than the space shuttle could send to low-Earth orbit.

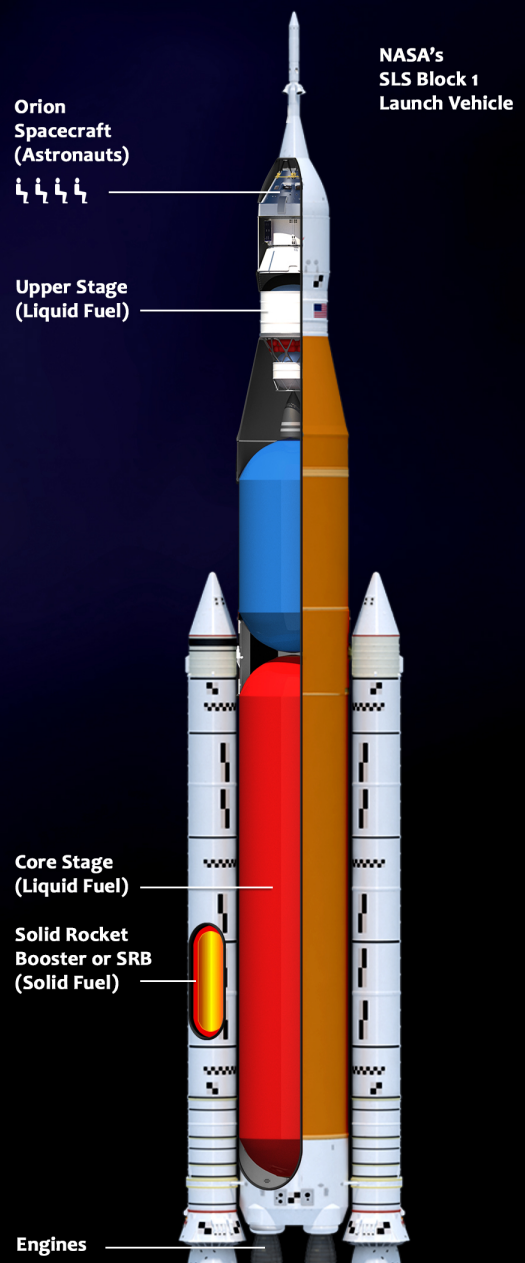
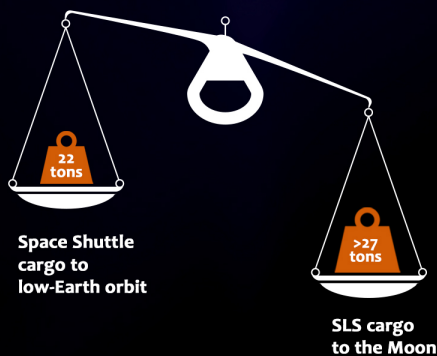

[www.nasa.gov/sls](http://www.nasa.gov/sls)

NASA's Space Launch System is powerful enough to send the Orion spacecraft beyond the Moon.

# Orbit, Moon, Mars, and All Points Between and Beyond

NASA's SLS heavy-lift rocket is being developed alongside many commercial rockets and spacecraft to open the solar system for exploration. All points are possible. The many benefits to be gained from this endeavor are still coming into view, but one thing is clear. The SLS rocket is bringing advanced capabilities within reach at last, inspiring the next generation of scientists, technicians, engineers, and mathematicians – students in today's classrooms – to greatness.

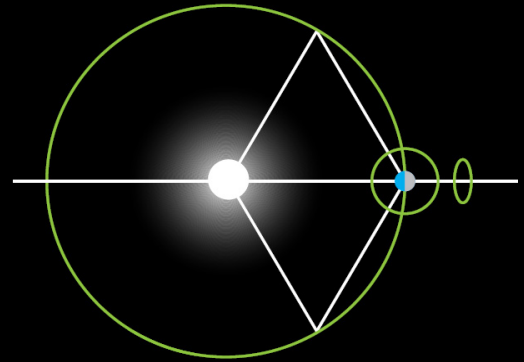

## Potential Benefits

- Geosynchronous-Earth Orbit
- New microgravity destinations
- Space construction, fueling, repair
- Space telescopes and Earth observatories



## The Moon

- Witness to the birth of Earth and the inner planets
- Critical resources

## Mars/Phobos/Deimos

- Life beyond Earth?
- Permanent base
- Witness to the birth of Earth and the inner planets
- Critical resources



# How Rockets Work

Whether flying a small model rocket or launching a giant cargo rocket to Mars, the principles of how rockets work are exactly the same. Understanding and applying these principles means mission success.

In the early days of rocketry, the flight of a fire arrow or other rocket device was largely a matter of chance. It might fly; it might skitter about, shooting sparks and smoke; or it might explode. Through centuries of trial and error, rockets became more reliable. However, real advancements in rocketry depended upon a scientific and mathematical understanding of motion. That came in the seventeenth century with the works of scientists such as Galileo and Isaac Newton.

Galileo conducted a wide range of experiments involving motion. Through studies of inclined planes, Galileo concluded that moving objects did not need the continuous application of force (in the absence of friction and drag) to keep moving. Galileo discovered the principle of inertia, that all matter, because of its mass, resists changes in motion. The more mass, the more resistance.

Isaac Newton, born the year Galileo died, advanced Galileo's discoveries and those of others by proposing three basic laws of motion. These laws are the foundation of all rocket science. Understand the laws and you know just about everything you need to build successful rockets. Apply the laws and you become a "rocket scientist."

## **"Newton's Laws of Motion**

In his master work entitled *Philosophia Naturalis Principia Mathematica* (usually referred to as *Principia*), Isaac Newton stated his laws of motion. For the most part, the laws were known intuitively by rocketeers, but their statement in clear form elevated rocketry to a science. Practical application of Newton's laws makes the difference between failure and success. The laws relate force and direction to all forms of motion.

## In simple language, Newton's Laws of Motion:

### First Law

Objects at rest remain at rest and objects in motion remain in motion in a straight line unless acted upon by an unbalanced force.

### Second Law

Force equals mass times acceleration (or  $f = ma$ ).

### Third Law

For every action there is an equal and opposite reaction.

Before looking at each of these laws in detail, a few terms should be explained.

*Rest* and *Motion*, as they are used in the first law, can be confusing. Both terms are relative. They mean rest or motion in relation to surroundings. You are at rest when sitting in a chair. It doesn't matter if the chair is in the cabin of a jet plane on a cross-country flight. You are still considered to be at rest because the airplane cabin is moving along with you. If you get up from your seat on the airplane and walk down the aisle, you are in relative motion because you are changing your position inside the cabin.

*Force* is a push or a pull exerted on an object. Force can be exerted in many ways, such as muscle power, movement of air, and electromagnetism, to name a few. In the case of rockets, force is usually exerted by burning rocket propellants that expand explosively.

*Unbalanced Force* refers to the sum total or net force exerted on an object. The forces on a coffee cup sitting on a desk, for example, are in balance. Gravity is exerting a downward force on the cup. At the same time, the structure of the desk exerts an upward force, preventing the cup from falling. The two forces are in balance.

Reach over and pick up the cup. In doing so, you unbalance the forces on the cup. The weight you feel is the force of gravity acting on the mass of the cup. To move the cup upward, you have to exert a force greater than the force of gravity. If you hold the cup steady, the force of gravity and the muscle force you are exerting are in balance.

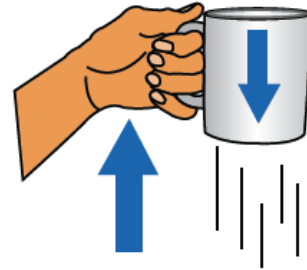

Unbalanced force

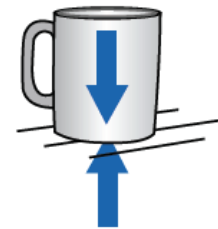

Balanced forces

Unbalanced force also refers to other motions. The forces on a soccer ball at rest on the playing field are balanced. Give the ball a good kick, and the forces become unbalanced. Gradually, air drag (a force) slows the ball, and gravity causes it to bounce on the field. When the ball stops bouncing and rolling, the forces are in balance again. Take the soccer ball into deep space, far away from any star or other significant gravitational field, and give it a kick. The kick is an unbalanced force exerted on the ball that gets it moving. Once the ball is no longer in contact with the foot, the forces on the ball become balanced again, and the ball will travel in a straight line forever. How can you tell if forces are balanced or unbalanced? If the soccer ball is at rest, constant speed and in a straight line, the forces are balanced. If the ball is accelerating or changing its direction, the forces are unbalanced.

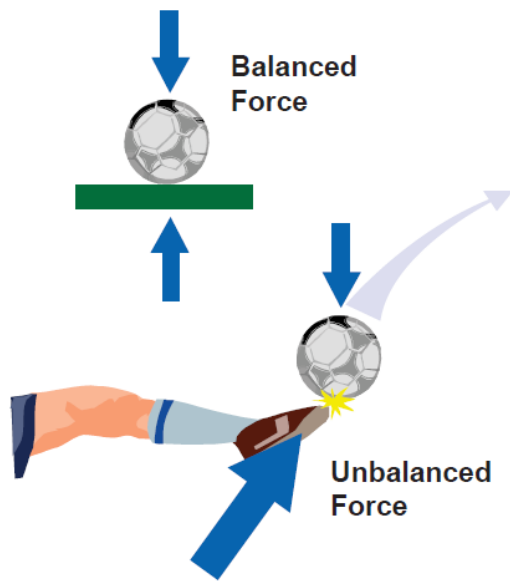

*Mass* is the amount of matter contained in an object. The object does not have to be solid. It could be the amount of air contained in a balloon or the amount of water in a glass. The important thing about mass is that unless you alter it in some way, it remains the same whether the object is on Earth, in Earth orbit, or on the Moon. Mass just refers to the quantity of matter contained in the object. (Mass and weight are often confused. They are not the same thing. Weight is a force and is the product of mass times the acceleration of gravity.)

*Acceleration* relates to motion. It means a change in motion. Usually, change refers to increasing speed, like what occurs when you step on the accelerator pedal of a car. Acceleration also means changing direction.

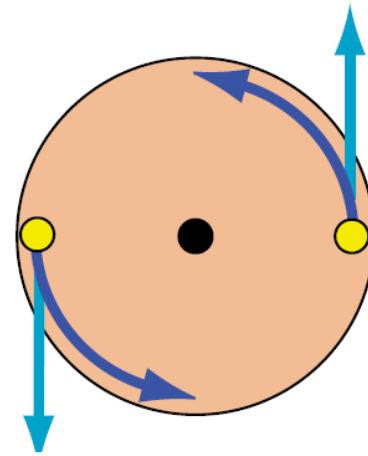
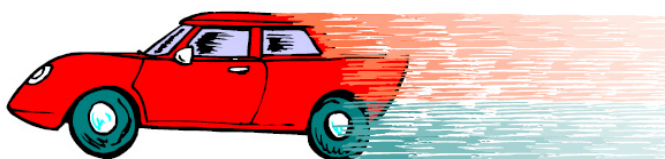

Top view of two riders on a carousel. The carousel platform exerts unbalanced forces on the riders, preventing them from going in straight lines. Instead, the platform continually accelerates the riders in a counterclockwise direction.

This is what happens on a carousel. Even though the carousel is turning at a constant rate, the continual change in direction of the horses and riders (circular motion) is an acceleration.

*Action* is the result of a force. A cannon fires, and the cannon ball flies through the air. The movement of the cannon ball is an action. Release air from an inflated balloon. The air shoots out the nozzle. That is also an action. Step off a boat onto a pier. That, too, is an action.

*Reaction* is related to action. When the cannon fires, and the cannon ball flies through the air, the cannon itself recoils backward. That is a reaction. When the air rushes out of the balloon, the balloon shoots the other way, another reaction. Stepping off a boat onto to a pier causes a reaction. Unless the boat is held in some way, it moves in the opposite direction. (Note: The boat example is a great demonstration of the action/reaction principle, providing you are not the one stepping off the boat!)

## Newton's First Law

This law is sometimes referred to as Galileo's law of inertia because Galileo discovered the principle of inertia. This law simply points

out that an object at rest, such as a rocket on a launch pad, needs the exertion of an unbalanced force to cause it to lift off. The amount of the thrust (force) produced by the rocket engines has to be greater than the force of gravity holding it down. As long as the thrust of the engines continues, the rocket accelerates. When the rocket runs out of propellant, the forces become unbalanced again. This time, gravity takes over and causes the rocket to fall back to Earth. Following its “landing,” the rocket is at rest again, and the forces are in balance.

There is one very interesting part of this law that has enormous implications for spaceflight. When a rocket reaches space, atmospheric drag (friction) is greatly reduced or eliminated. Within the atmosphere, drag is an important unbalancing force. That force is virtually absent in space. A rocket traveling away from Earth at a speed greater than 11.186 kilometers per second (6.95 miles per second) or 40,270 kph (25,023 mph) will eventually escape Earth’s gravity. It will slow down, but Earth’s gravity will never slow it down enough to cause it to fall back to Earth. Ultimately, the rocket (actually its payload) will travel to the stars. No additional rocket thrust will be needed. Its inertia will cause it to continue to travel outward. Four spacecraft are actually doing that as you read this. Pioneers 10 and 11 and Voyagers 1 and 2 are on journeys to the stars!

## Newton’s Third Law

(It is useful to jump to the third law and come back to the second law later.) This is the law of motion with which many people are familiar. It is the principle of action and reaction. In the case of rockets, the action is the force produced by the expulsion of gas, smoke, and flames from the nozzle end of a rocket engine. The reaction force propels the rocket in the opposite direction. When a rocket lifts off, the combustion products from the burning propellants accelerate rapidly out of the engine. The rocket, on the other hand, slowly accelerates skyward. It would appear that something is wrong here if the action and reaction are supposed to be equal. They are equal, but the mass of the gas, smoke, and flames being propelled by the engine is much less than the mass of the rocket being propelled in the opposite direction.

Even though the force is equal on both, the effects are different. Newton’s first law, the law of inertia, explains why. The law states that it takes a force to change the motion of an object. The greater the mass, the greater the force required to move it.

## Newton’s Second Law

The second law relates force, acceleration, and mass. The law is often written as the equation:

$$f = ma$$

The force or thrust produced by a rocket engine is directly proportional to the mass of the gas and particles produced by burning rocket propellant times the acceleration of those combustion products out the back of the engine. This law only applies to what is actually traveling out of the engine at the moment and not the mass of the rocket propellant contained in the rocket that will be consumed later.

The implication of this law for rocketry is that the more propellant (m) you consume at any moment and the greater the acceleration (a) of the combustion products out of the nozzle, the greater the thrust (f).

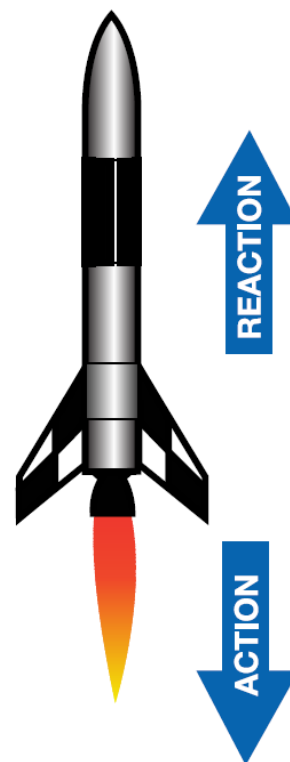

## A Taste of Real Rocket Science

Naturally, launching rockets into space is more complicated than Newton's laws of motion imply. Designing rockets that can actually lift off Earth and reach orbital velocities or interplanetary space is an extremely complicated process.

Newton's laws are the beginning, but many other things come into play. For example, air pressure plays an important role while the rocket is still in the atmosphere. The internal pressure produced by burning rocket propellants inside the rocket engine combustion chamber has to be greater than the outside pressure to escape through the engine nozzle. In a sense, the outside air is like a cork in the engine. It takes some of the pressure generated inside the engine just to exceed the ambient outside pressure. Consequently, the velocity of combustion products passing through the opening or throat of the nozzle is reduced. The good news is that as the rocket climbs into space, the ambient pressure becomes less and less as the atmosphere thins and the engine thrust increases.

Another important factor is the changing mass of the rocket. As the rocket is gaining thrust as it accelerates upward due to outside pressure changes, it is also getting a boost due to its changing mass. Every bit of rocket propellant burned has mass. As the combustion products are ejected by the engine, the total mass of the vehicle lessens. As it does its inertia, or resistance to change in motion, becomes less. As a result, upward acceleration of the rocket increases.

In practical terms, Newton's second law can be rewritten as this:

$$f = m_{exit} V_{exit} + (p_{exit} - p_{ambient}) A_{exit}$$

("A" refers to the area of the engine throat.)

When the rocket reaches space, and the exit pressure minus the ambient pressure becomes zero, the equation becomes:

$$f = m_{exit} V_{exit}$$

In real rocket science, many other things also come into play.

- Even with a low acceleration, the rocket will gain speed over time because acceleration accumulates.
- Not all rocket propellants are alike. Some produce much greater thrust than others because of their burning rate and mass. It would seem obvious that rocket scientists would always choose the more energetic propellants. Not so. Each choice a rocket scientist makes comes with a cost. Liquid hydrogen and liquid oxygen are very energetic when burned, but they both have to be kept chilled to very low temperatures. Furthermore, their mass is low, and very big tanks are needed to contain enough propellant to do the job.

## In Conclusion...

Newton's laws of motion explain just about everything you need to know to become a rocket scientist. However, knowing the laws is not enough. You have to know how to apply them, such as:

- How can you create enough thrust to exceed the weight of the rocket?
- What structural materials and propellant combinations should you use?
- How big will the rocket have to be?
- How can you make the rocket go where you want it to?
- How can you bring it back to Earth safely?

# Applying Newton's Laws

The next step in becoming a rocket scientist is to apply rocket science and mathematics to the design and construction of actual rockets. There are many tricks of the trade for maximizing thrust and reducing rocket mass. Each of these tricks is an application of one or more of Newton's laws. Although there are many different kinds of rockets, the same laws apply to all.

Rockets are generally classified as either solid or liquid. They produce thrust by burning propellants and expelling the combustion products out of the engine. Propellants are simply a combination of fuel and oxidizer. The oxidizer for solid propellants is a chemical containing oxygen. For example, gunpowder, used in the engines of model rockets, contains potassium nitrate ( $\text{KNO}_3$ ). Potassium nitrate provides the oxygen needed for the other gunpowder chemicals to burn rapidly. The oxidizer for liquid rockets is usually pure oxygen chilled to 90 K ( $-183^\circ\text{C}$  or  $-297.3^\circ\text{F}$ ) so that it condenses into liquid oxygen (LOX).

The propellants for rockets are held in tanks or within cases. This is both an advantage and a disadvantage. Because they carry their propellants (oxygen onboard), rockets can work in space. No other presently available vehicle can do that. A jet engine cannot function in space because it is an "air-breather." Although jets and rockets both employ Newton's law of action and reaction, the jet needs to draw in air from the atmosphere to burn its fuel. This limits the altitude of a jet plane.

## Solid Propellant Rockets

The first true rockets, "fire arrows" invented by the Chinese, employed solid propellants. An early form of gunpowder was packed into a cylinder closed at one end. On the other end was an opening. When the gunpowder was ignited, it burned very quickly and created great quantities of gas and other combustion products that rushed out of the hole. This produced thrust. Flight control was accomplished by attaching a long stick to the rocket to create drag as the rocket sailed through the air. This wasn't a very accurate system, but the rocket usually flew in the intended direction.





Four-stage, solid propellant Scout rocket.

More than 1,000 years later, solid propellant rockets are not appreciably different from the Chinese fire arrows. The solid rocket boosters (SRBs) for the space shuttle were very large tubes packed with propellants that are closed at one end and have a hole at the other. The SRBs do have many other sophisticated innovations, but, in principle, they are no different from their primitive ancestors.

Solid propellant rockets have a simple design. They consist of a case or tube in which the propellants are packed. Early rockets used cases made of paper, leather, and iron. Modern rockets use a thin and lightweight metal such as aluminum. Making the case from thin metal reduces the overall weight of the structure and increases flight performance. However, the heat from the burning propellants could easily melt through the metal. To prevent this, the inner walls of the case have to be insulated.

The upper end of the rocket is closed and capped with a payload section. The lower end of the rocket is constricted with a narrow opening called the throat, above a larger cone-shaped structure, called the nozzle. By constricting the opening, the throat causes the combustion products to accelerate greatly as they race to the outside (second law). The nozzle aims the exhaust straight downward so that the rocket travels straight upward (third law).

To appreciate how the throat of the rocket accelerates the combustion products, turn on the water for a garden hose. Open the nozzle to the widest setting. Water slowly flows out. Next, reduce the opening of the nozzle. Water quickly shoots out in a long stream (second law) and the hose pushes back on you (third law).

The propellant in solid rockets is packed inside the insulated case. It can be packed as a solid mass or it may have a hollow core. When packed as a solid mass, the propellant burns from the lower end to the upper end. Depending upon the size of the rocket, this could take a while. With a hollow core, the propellants burn much more rapidly because the entire face of the core is ignited at one time. Rather than burning from one end to the other, the propellant burns from the core outward, towards the case. The advantage of a hollow core is that the propellant mass burns faster, increasing thrust (second law).

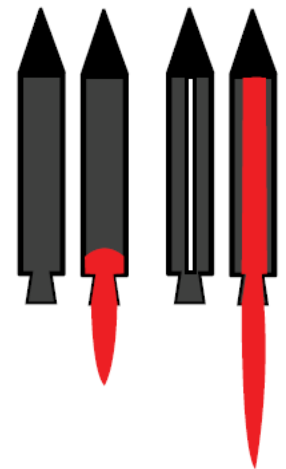
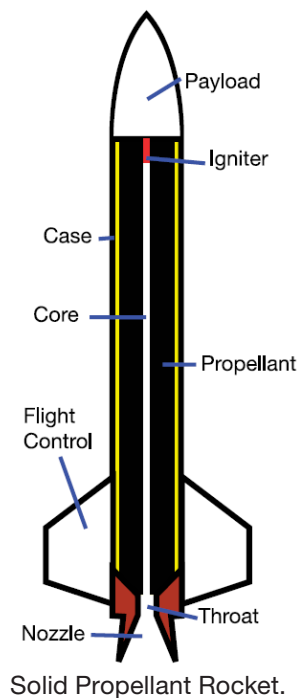

End-burning and hollow core rockets.

To make solid rockets even more powerful, the core doesn't have to be round. It can have other shapes that increase the surface area available for burning. The upper ends of the space shuttle SRBs had star-shaped cores. When ignited, the large surface area of the star points boosted liftoff thrust. In about one minute, however, the points burned off, and the thrust diminished somewhat. This was done on purpose because the space shuttle begins accelerating through the sound barrier. Passing through causes vibrations that are diminished by the temporary thrust reduction of the SRBs (second law).

Solid propellant rockets have two other major systems at work. One is the control system, which will be discussed later. The other is the igniter.

The Chinese fire arrows were ignited with fuses. This was a dangerous practice because the fuse could burn too quickly and not give the rocketeer time to get out of the way. Fuses were used for centuries until they were replaced by electric ignition. With an electric system, a wire with high resistance heats and ignites the propellant.

The space shuttle's SRBs and the SRBs that will be used for the new SLS rockets have a more dynamic ignition system. A small rocket motor is mounted inside the upper end of the core. When it ignites, it shoots a long tongue of flame down the core to ignite the entire surface at once. This causes the SRBs to reach full thrust in less than one second.

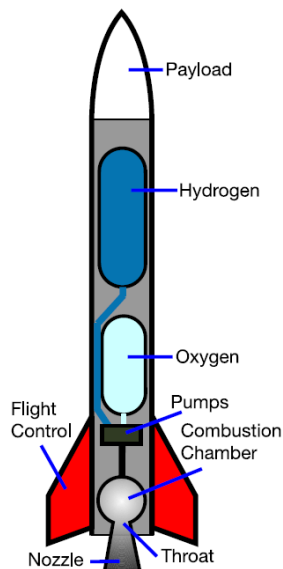

Liquid propellant rocket.

## Liquid Propellant Rockets

Liquid propellant rockets are an invention of the twentieth century. They are far more complex than solid rockets. Generally, a liquid rocket has two large tanks within its body. One tank contains a fuel, such as kerosene or liquid hydrogen. The other tank contains liquid oxygen.

When the liquid rocket engine is fired, high-speed pumps force the propellants into a cylindrical or spherical combustion chamber.

The fuel and oxidizer mix as they are sprayed into the chamber. There they ignite, creating huge quantities of combustion products that shoot through the throat and are focused downward by the nozzle. (Remember how the laws control this!) Liquid propellant engines have a number of advantages over solid propellant engines. A wider array of propellant combinations are available for different applications. Some of these require an ignition system. Liquid propellant rocket and others simply ignite on contact. Monomethylhydrazine (fuel) and nitrogen tetroxide (oxidizer) ignite spontaneously. These are called hypergolic propellants. With hypergolic propellants, a rocket engine does not need an ignition system.

Hypergolic propellants are great for reaction control thrusters like those that will be arrayed around the Orion service module.



RS-68 Liquid propellant engine test firing.

Another advantage of liquid propellants is that they can be controlled. Adjusting their flow into the combustion chamber adjusts the amount of thrust produced. Furthermore, liquid engines can be stopped and restarted later. It is very difficult to stop a solid propellant rocket once it is started, and thrust control is limited.

Naturally, with any technology, there is a price to pay. The engine of a liquid propellant rocket is very complex and subject to failure. It also has more structural mass than comparable solid propellant rockets. One method for mass reduction is to use thin, lightweight metal for The full stack of the Orion spacecraft is shown. The Launch Abort System aeroshell surrounds the Orion crew module for liftoff. Reaction control thrusters (eight in total) are seen at the bottom of the Service Module surrounding the Orbital Maneuvering System Engine.



**LAUNCH  
ABORT  
SYSTEM**



**ORION  
CREW  
MODULE**

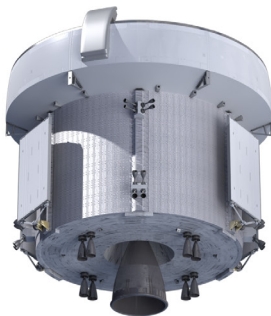

**SERVICE  
MODULE**

the nozzle. Normally, the nozzle is very thick and heavy, to prevent it from eroding away in the high-temperature streams of exhaust gases. A thin-wall nozzle needs a cooling system. Small tubes lace the walls and carry liquid hydrogen. Hydrogen becomes a liquid at 20.27 K (-252.87 ° C or -423.17 ° F). The super cold hydrogen absorbs the heat from the gas stream and protects the walls of the nozzle. The hydrogen, now heated, is then injected into the combustion chamber. With this system, the engine has less mass and produces greater thrust (second law again!).

## Controlling Flight

Newton's third law gets a workout in the control systems for rockets. Launch rods for old rockets were ineffective. Military rockets were launched by the thousands so that at least a few would hit their targets. Accuracy improved when small vanes were added to the exhaust stream. The vanes imparted stability by causing the rockets to spiral like bullets.

Another technique was to add fins, like the feathers on an arrow, to the lower end of the rocket case. As long as a rocket flies "straight as an arrow," the fins provide little drag or friction with the air. However, if the engine end of the rocket begins "fishtailing," drag increases greatly. The air stream strikes the fin, and the fin directs the stream to the side. The lower end of the rocket moves the opposite way and corrects the fishtailing (Newton's third law). Fins are used extensively with model rockets and small missiles.

Rocket fins on model rockets are a passive system for flight control. They remain fixed and do their job if the rocket starts going astray. Robert Goddard took fins a giant step forward by turning them into an active system. Goddard's fins could be made smaller (and lighter!) because they were not fixed. Even a slight straying from the planned course would cause the fins to react and tilt slightly in the appropriate direction.

The heart of Goddard's control system, later used in the V2 and other advanced rockets, was a gyroscope. Gyroscopes, which are a kind of top, spin at high speeds and

become stable due to their inertia (first law). In other words, the axis of the gyroscope points in one direction. If the rocket veers from course, the movement acts on the alignment of the gyroscope, and a linkage or an electrical system connected to the gyroscope transmits the appropriate corrections to the movable rocket fins.

You can get an idea of the effectiveness of movable fins with a simple demonstration. Balance the end of a long stick on the palm of your hand. If the stick starts tilting to the right, you automatically move your hand to the right to straighten up the stick. Movable fins do the same thing. The rocket starts tilting to the right. The leading edge of the fins bend to the right. This causes the air stream to be deflected to the left. The lower end of the rocket moves to the right, and the rocket is back on course.

Naturally, some fins are more complicated than just described. Depending upon the rocket design, the entire fin may not move. Instead, a lower flap might be the controllable part of the fin (kind of like a rudder). Very small movable fins might also be placed towards the nose of the rocket. These are called *canards*, and they permit rapid and extreme control maneuvers for air-to-air military missiles. Small fins, called vanes, may be placed within the exhaust stream of the engine. When a vane tilts, it directs part of the exhaust to one side or another. The lower end of the rocket responds by moving the other way. All of these fin styles are examples of Newton's third law in action.

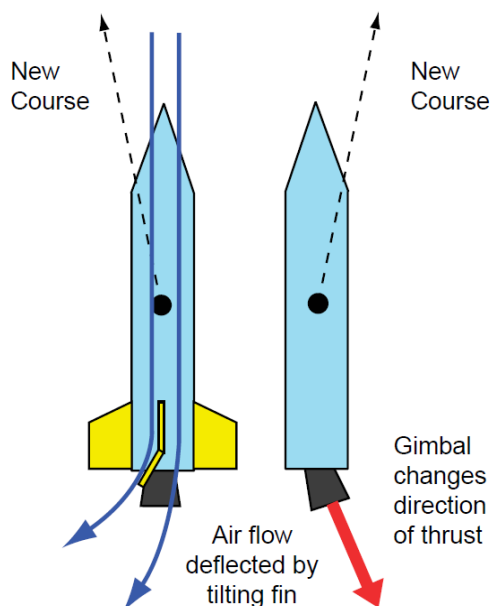

Another way the third law is applied for controlling flight is through gimballed engine nozzles. *Gimballed* means the nozzle can tilt in different directions. Movements of the nozzle can steer the rocket on a new course or make course corrections. The solid rocket boosters that will be used for the SLS rockets will use gimbaling for control.

## Controlling Mass

The total mass of a rocket has a major influence on its performance. If the rocket has a greater mass than the engines are capable of lifting, the rocket remains stuck on Earth (first law). The lighter the rocket, the better. However, since the rocket must carry all of its propellants (there aren't any filling stations in space —YET!), a big part of the rocket's mass has to be its propellants. The mass of the propellants burned is a big part of thrust (second law). Mass savings have to come from elsewhere — the rocket structure.

Engineering rocket tanks out of lightweight materials strengthened by ribs is a great way of saving mass. Chilling hydrogen and oxygen propellants until they liquefy reduces their total volume. That means smaller, less massive tanks can be used. Gimbaling engines for control means that heavy fins can be eliminated.

When designing new rockets, rocket scientists (and engineers) concern themselves with mass fraction. Mass fraction is a simple inverse mathematical relationship between the mass of the propellants of the rocket and the total mass of the rocket. Although there is

$$MF = \frac{\text{mass (propellant)}}{\text{mass (total rocket)}}$$

wiggle room in this equation, the most efficient rockets have mass fractions of about 0.91. That means that of the total rocket, propellant accounts for 91% of its mass. The rocket structure and payload comprises the other 9%. Since you need the mass of the propellants, efforts on saving mass are primarily focused on structure and payload.

One simple but old trick is staging. Begin with a large rocket, stack a smaller one on top of it, stack a still smaller rocket on top of the second one, and then the payload on top of the third rocket. The large rocket lifts its own mass and the mass of the other two. When the large rocket (first stage) is empty, it drops off. The second rocket (second stage) fires and accelerates itself and the third stage with its payload to higher speeds and altitudes. When it is empty, the second stage is dropped, and the third stage finishes the job of delivering the payload. By staging, the mass of the rocket is reduced in flight, making the upper stages more efficient in doing their jobs.

## Future Rockets

Part of the fun of rocket science is that there are always new ideas and new ways of doing things. Solid and liquid rockets are not the only way to go. Other kinds of rockets are “on the drawing board,” going through prototype testing, or churning about in the imaginations of dreamers.

Electric rockets have been around since the 1960s. Rather than burning propellants, ions — electrically charged atoms — are driven out of the rocket engine using magnetic forces. In doing so, a very small thrust is imparted to the rocket. (Newton’s laws are still at work in this rocket.) Electric rockets, sometimes referred to as “ion drive,” are very efficient in converting electrical energy into thrust, but since the mass of ions is very low, the thrust is small, about the force needed to push a walnut across a table. One would think, “Why bother?” The answer is that ion drive can function continuously for months or years on end. It may start off slow, but after months and months of thrusting a vehicle could achieve velocities higher than a chemical rocket that burns all its propellants in a few minutes. Another thing — the electricity for ion drives can come from sunlight captured by solar panels on the spacecraft.

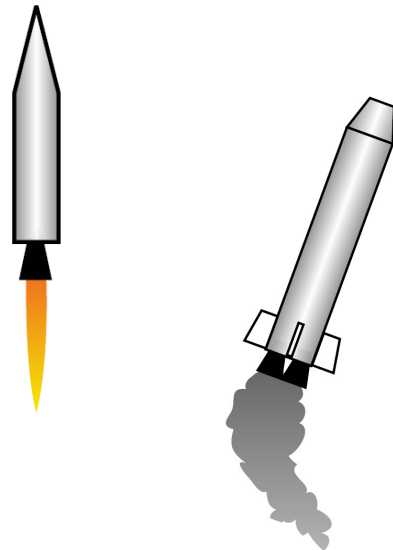

Nuclear power is also under consideration for rocket propulsion. An onboard nuclear reactor would generate lots of heat through nuclear fission (breaking down of radioactive atoms). A supply of hydrogen gas would be heated by the reactor, causing the gas molecules to expand rapidly and stream out of the engine nozzle. No burning would be involved. Think of this kind of rocket as a nuclear-powered balloon.

Still another concept is beaming a powerful laser from Earth towards collectors on a spacecraft. The energy received would be used to heat a supply of gas for propulsion. In this way, the nuclear reactor could be eliminated.

Still further in the future, matter/antimatter drives, such as those proposed in Star Trek, might actually be possible. Where we go and how we will get there all comes down to the rocket scientists of the future, who are sitting in classrooms today.

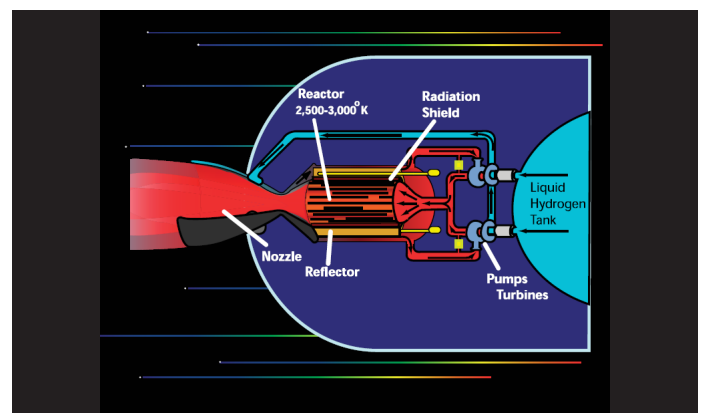

Proposed nuclear thermal rocket engine.

# Rocket Activities

There are few classroom topics that generate as much excitement as rockets. The scientific, technological, engineering, and mathematical (STEM) foundations of rocketry provide exciting classroom opportunities for authentic hands-on, minds-on experimentation. The activities and demonstrations that follow are suitable for students at many grade levels.

For the most part, material and tool requirements are simple, but a few of the bigger projects require launch platforms that need to be constructed or purchased in advance. Although purchasing platforms from school science catalogs and specialty companies is an option, constructing your own is a learning process in which you can involve your students. Minimal proficiency with tools (saw, screw driver) is required. Detailed instructions (with lots of illustrations!) are provided.

As you review the activities you will notice that each supports state and national educational standards for science, technology, and mathematics. A matrix identifying specific national standards and recommended grade levels follow on the next two pages. You may “cherry-pick” activities, but linking several or using all of the activities will provide your students with a memorable and beneficial STEM unit and turn your students into “rocket scientists.” *You Are Go For Launch!*

## **A Note about Measurement**

Where possible, all measurements used in the activities are metric. However, English units are often employed when constructing devices because most materials and parts are sized with English measures.

# National Curriculum Standards

The rocket activities in this guide support national curriculum standards (current at the time of its writing) for science, mathematics, and technology. The standards identified for each activity are based on science standards developed by the National Research Council and the mathematics standards developed by the National Council of Teachers of Mathematics. While not practical to identify individual standards by state, national standards provide a guide for selecting activities that meet local needs.

## National Science Education Standards

K-12

### National Research Council

- Evidence, models, and explanation
- Change, constancy, and measurement
- Abilities necessary to do scientific inquiry
- Position and motion of objects
- Motions and forces
- Properties of objects and materials
- Abilities of technologic design
- Understanding about science and technology
- Risks and benefits
- Science and technology in local challenges

### Rocket Activities

	Unifying Concepts and Processes		Science as Inquiry		Physical Science			Science and Technology			
Pop Can "Hero Engine"		✓		✓	✓	✓			✓		
3...2...1...PUFF!	✓			✓	✓	✓		✓			
Heavy Lifting				✓	✓	✓		✓			
Newton Car	✓	✓		✓	✓	✓	✓		✓		
Rocket Races		✓		✓	✓	✓		✓			
Pop! Rocket Launcher					✓	✓		✓			
Pop! Rockets	✓	✓		✓	✓	✓		✓			
Foam Rocket	✓	✓		✓	✓	✓	✓	✓			
Launch Altitude Tracker					✓	✓			✓		
Water Rocket Launcher					✓	✓		✓			
Water Rocket Construction					✓	✓		✓			
Project X-51	✓	✓		✓	✓	✓				✓	✓

# Principles and Standards for School Mathematics

Pre K-12

National Council of Teachers and Mathematics

		Number and Operations	Algebra	Geometry	Measurement	Data Analysis and Probability	Problem Solving	Reasoning and Proof	Communication	Connections	Representation
Pop Can "Hero Engine"	<b>Content Standards</b>	✓	✓			✓		✓	✓	✓	✓
3...2...1...PUFF!		✓		✓	✓	✓			✓	✓	
Heavy Lifting		✓				✓	✓	✓	✓	✓	✓
Newton Car		✓			✓	✓	✓	✓	✓	✓	✓
Rocket Races		✓		✓	✓	✓	✓	✓	✓	✓	✓
Pop! Rocket Launcher					✓			✓			
Pop! Rockets		✓		✓	✓	✓	✓	✓	✓	✓	✓
Foam Rocket		✓	✓	✓	✓	✓		✓	✓	✓	✓
Launch Altitude Tracker		✓		✓	✓	✓	✓	✓	✓	✓	✓
Water Rocket Launcher					✓				✓		
Water Rocket Construction				✓	✓				✓		
Project X-51	<b>Process Standards</b>	✓		✓	✓	✓	✓	✓	✓	✓	✓



# Suggested Grade Levels

The matrix below displays suggested grade levels for the activities in this guide. Each activity is appropriate for a wide range of student abilities. Although grade levels are suggested, small modifications will enable activities to be used successfully with other grade levels. One area of potential adjustment are the student pages. The reading level and vocabulary on these pages may be below or above your students' abilities. Many of the activities contain tips, suggestions, and extensions that will assist you in preparing the lesson for the appropriate audience.

## Suggested Grade Levels

### Rocket Activities

	K	1	2	3	4	5	6	7	8	9	10	11	12
Pop Can "Hero Engine"	✓	✓	✓	✓	✓	✓	✓	✓	✓				
3...2...1...PUFF!	✓	✓	✓	✓	✓	✓	✓	✓	✓				
Heavy Lifting	✓	✓	✓	✓	✓	✓	✓	✓	✓				
Newton Car				✓	✓	✓	✓	✓	✓	✓	✓	✓	✓
Rocket Races				✓	✓	✓	✓	✓	✓	✓	✓	✓	✓
Pop! Rockets Launcher	✓	✓	✓	✓	✓	✓	✓						
Pop! Rockets	✓	✓	✓	✓	✓	✓	✓						
Foam Rocket					✓	✓	✓	✓	✓	✓	✓	✓	✓
Launch Altitude Tracker					✓	✓	✓	✓	✓	✓	✓	✓	✓
Water Rocket Launcher					✓	✓	✓	✓	✓	✓	✓	✓	✓
Water Rocket Construction					✓	✓	✓	✓	✓	✓	✓	✓	✓
Project X-51					✓	✓	✓	✓	✓	✓			

# Rocket Activity

## Pop Can

### “Hero Engine”

#### Objective

To investigate Newton’s third law of motion using thrust produced by falling water.

#### Description

Small student teams will construct water propelled engines out of soft drink cans and investigate ways to increase the action-reaction thrust produced by water shooting out of holes punched in the can sides.



#### Materials

- 4 empty aluminum soft drink cans per team, with pull tabs intact
- Carpenter’s nails of different sizes ( 6,12, 16D, etc.)
- String (about 50 cm)
- Water tub (large plastic storage tub, small kiddie pool, sink, etc.)
- Water
- Towels
- Rulers
- Stickers or bright permanent marker

#### Management

Divide your students into small groups. Set up one or more water tubs around your classroom and fill the tubs with about 20 cm of water. Have no more than one or two teams test their engines at one time. Discuss the importance of keeping the water in the tubs. When engines are filled, they should not be raised any higher than the rim of the tub. This will keep water coming out of the holes from falling on the surrounding floor. Be sure to recycle the cans at the conclusion of the activity.

#### National Science Content Standards

- Unifying Concepts and Processes
  - Change, constancy, and measurement
- Science as Inquiry
  - Abilities necessary to do scientific inquiry
- Physical Science
  - Position and motion of objects
  - Motions and forces
- Science and Technology
  - Understanding about science and technology

#### National Mathematics Content Standards

- Number and Operations
- Measurement
- Data Analysis and Probability

#### National Mathematics Process Standards

- Reasoning and Proof
- Communication
- Connections
- Representations

## Background

This activity simulates the operation of the classic aeolipile engine invented by Hero of Alexandria more than 2,000 years ago.... (See page 2.) Hero's engine was a spinning copper sphere that was propelled by a thrust produced by a jet of steam. The engine was an early demonstration of the action-reaction principle (third law of motion) stated by Sir Isaac Newton 1,700 years later.... (See page 4.) Steam, shooting out through two L-shaped holes, creates an action force that is accompanied by an equal reaction force in the opposite direction.

Hero's invention was not self-contained and therefore, not a true rocket device. Heat to generate the steam had to be applied externally. Rockets are completely self-contained.

In this activity, a Hero engine-like device is created by the students. Holes are punched in the side of a soft drink can. The holes are angled pinwheel fashion. A string, tied to the pull tab, supports the can and permits it to rotate. The can is immersed in water and pulled out. Gravity draws the water through the angled holes, and streams shoot out in either a clockwise or counterclockwise direction. The streams produce an action force that is accompanied by a reaction force. The can spins in the opposite direction.

There are many potential variables with the Pop Can Hero engine. Hole size, hole angle, number of holes, and the placement of the hole above the base of the can all affect the thrust produced. The most significant of these variables is the hole placement. The greatest thrust occurs when the holes are punched just above the bottom of the can. This is a gravity effect. The strength of the water stream (thrust) is based on the pressure. Water pressure in a container is the greatest at the bottom. The pressure at the top of the water in the container is zero (ignoring air pressure in this example). Water dribbles out of a hole near the top of the column. The water stream gets stronger the closer the hole is to the container bottom. Thrust stops when water drains out to the level of the holes. Holes at the bottom of the container produce thrust for a longer time. However, the magnitude of the thrust diminishes as the water column lowers (pressure drops with column height).

**Tip** Ask students to bring undented and washed soft drink cans from home. You will need at least three cans per student team.

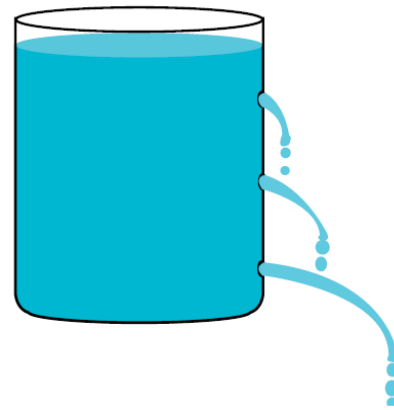

The three holes in this container each produce a water stream. Greater pressure at the bottom makes the stream shoot out farther.

The effects of the other variables are many. For example, more holes means more water streams out of the can, but the water drains from the can more quickly. Large holes drain water more quickly than small holes. Holes angled in different directions counteract each other. Holes that are not angled produce water streams that leave the can perpendicular and no rotation occurs. (The object is to have students discover the effects of the different variables themselves.)

## Procedure

### Making the Pop Can "Hero Engine"

1. Divide your students into small teams of two or three members.
2. Demonstrate the procedure for punching holes in the cans. The idea is to punch the hole without crushing the can sides. Place the nail point near the bottom rim of the can. Apply pressure with the nail, turning it, if necessary, to make the hole.
3. When the hole is punched, push the nail head to the right or to the left. This will angle the hole so that water will stream out on a tangent to produce thrust.

4. Rotate the can 1/4 turn and punch a second hole. Again angle the hole (in the same direction as before).

5. Repeat the procedure two more times to make four holes in total. (Cans may have different numbers of holes.)

6. Tie a string to the pop tab.

7. Place a sticker or a dot with a permanent marker near the top of the can. (The sticker or dot helps students count the rotations.)

8. Immerse the can in the tub of water.

9. When the can is full of water, lift it out by the string and observe the rotational motion.

## Procedure

### Student Team Experiment

1. Provide each team with copies of the “Pop Can Hero Engine” experiment sheet.

2. Review the instructions on the page and discuss the objective. (“Design an experiment to find a way to increase the number of rotations the Pop Can Hero Engine makes.”).

3. Make a list of student ideas for variables to test (hole size, number of holes, etc.). Discuss the importance of changing only one thing at a time. The first Hero engine they create will serve as the baseline experiment. The second and third engines will vary just one thing (e.g., Can 1 - medium size holes, Can 2 - smaller holes, Can 3 - larger holes).

4. Discuss ideas for keeping track of the number of rotations the cans make. (Place a large bright mark on one side, etc.).

5. Give teams time to pick their experiment, devise their hypothesis, and write the procedures they will follow on their experiment page.

6. Distribute the materials to the teams and have them begin their investigation.

**Tip** Make sure the nails used for punching holes have good points on them. They do not have to be needle sharp, just not blunt.

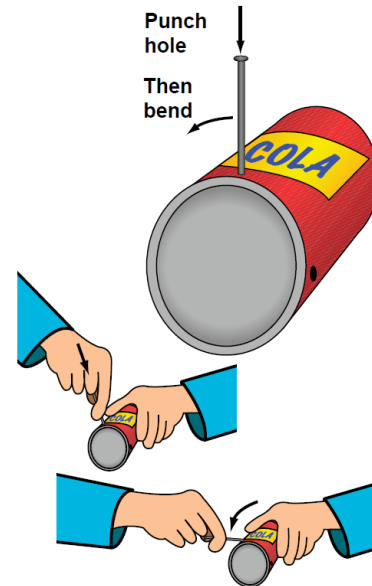

## Discussion

- What provides the force that causes the cans to rotate?

Actually, there are a combination of factors that contribute to the force that causes the cans to rotate. The most important is the force of gravity. It attracts the water in the can and causes it to stream out the holes. The shape of the hole directs the water streams. The diameter of the hole determines how fast the water streams out, etc.

- Which of Newton’s laws of motion explains why the can rotates in the opposite direction from the direction of the water streams? Newton’s third law of motion.
- Based on the results of the individual team experiments, what could you do to maximize the number of rotations of the Pop Can Hero Engines?

Individual answers: combine best hole size with the right number of holes, best placement, etc.

## Assessment

- Ask teams to state their experiment hypotheses, explain their procedures, and present their results. Make a list of the different ways one can increase the number of rotations the Hero engine makes.
- Have teams submit their completed data sheet with their written conclusion based on their results.

## Extensions

- Construct an actual steam-powered hero engine and use it as a demonstration device. Although not difficult to construct, the engine will require some basic construction skills, principally soldering. You will need the following materials:

-Copper toilet tank float (available from plumbing supply stores and from on-line plumbing supply stores - search “copper toilet tank floats.”

- 12” copper tube, 3/16” diameter (from hobby shops)

- Thumbscrew to fit threads for float arm attachment

-Metal file

-3/16” drill

-solder

-propane torch

-pliers

-string

-water

-eye protection

1. File a notch in the center of the tube. Do not file all the way through. In Instruction 3, the tube will be inserted completely through the sphere. This supports the tube while it is being soldered. (See diagram to the right.)

2. Drill 3/16th-in. holes through opposite sides of the float just above the “equator” joint.

3. Insert the tube through the holes. Lightly heat the place where the tubes contact the sphere. Touch solder to the contact point to seal the tube to the float.

4. Apply heat to soften the opposite ends of the tube until they bend easily. Using pliers to grasp the ends, bend the tube ends into an L shape. Be careful not to overheat or bend too forcefully, or the tube may flatten on the bend.

5. Drill through the center of the threads for the attachment point for the float arm. This will open a water-filling hole into the float.

6. Drill a hole through the flat side of the thumb screw to permit tying of the string.

7. Pour about 30 milliliters of water (about 1 table-spoon) into the float through the filling hole.

8. Thread the thumbscrew into the hole and attach the string.

9. Suspend the engine from above and gently heat the bottom of the engine with a torch. Be sure to wear eye protection. When the water boils, steam will be produced that will jet out of the two nozzles and propel the engine.

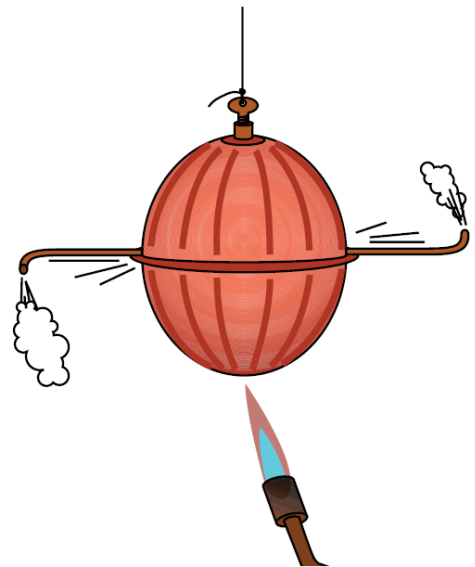

Filing produces an opening in the tube through which the steam can pass.

**Tip** Before using your steam Hero engine, confirm the tubes are not blocked by blowing through them. If air comes out the opposite tube, the engine is safe to use.

# Pop Can Hero Engine

Team Member Names: \_\_\_\_\_

Design an experiment to find a way to increase the number of rotations the Pop Can Hero Engine makes.

Write your experiment hypothesis below.

---

---

Briefly explain your experiment procedures below.

---

---

---

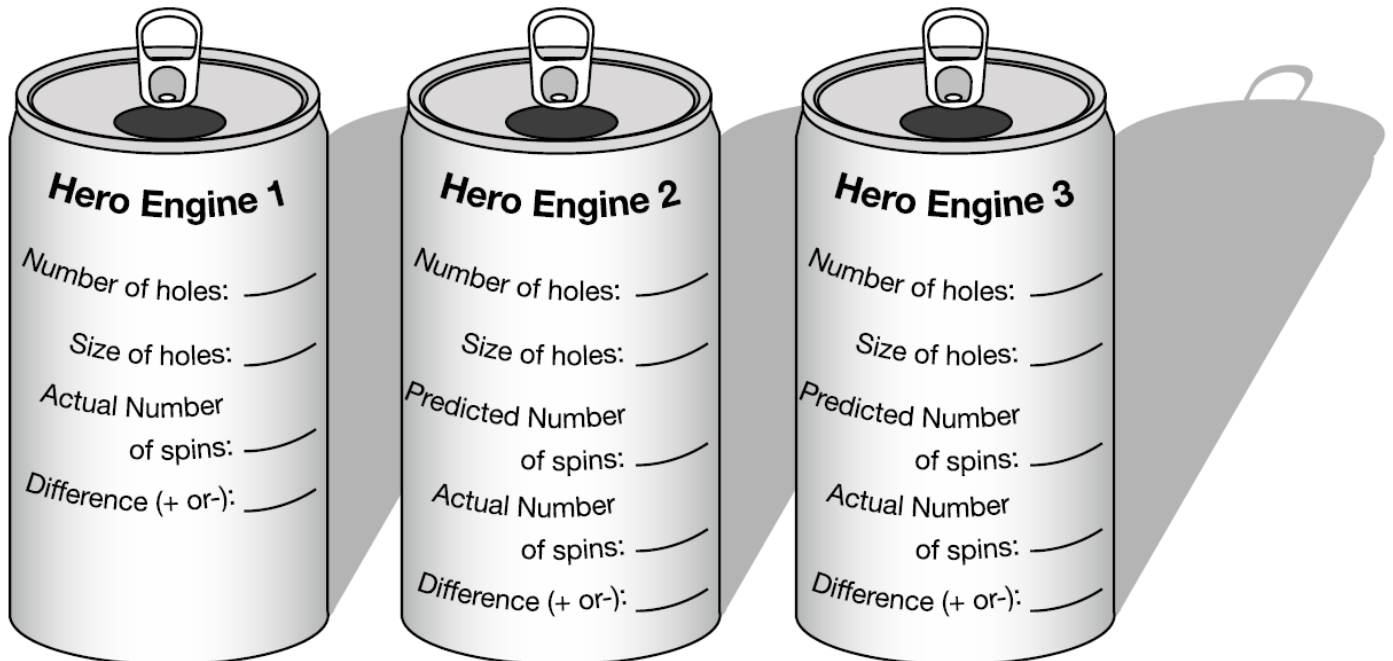

Based on your results, was your hypothesis correct? \_\_\_\_\_

Why? \_\_\_\_\_

# Pop Can Hero Engine

Design and build a new Hero Engine that maximizes rotation rate.

What things did you learn from your experiment and the experiments of others for increasing the Hero Engine rotation rate?

---

---

Briefly describe your new Hero Engine (hole size, number of holes, placement, etc.)

---

---

---

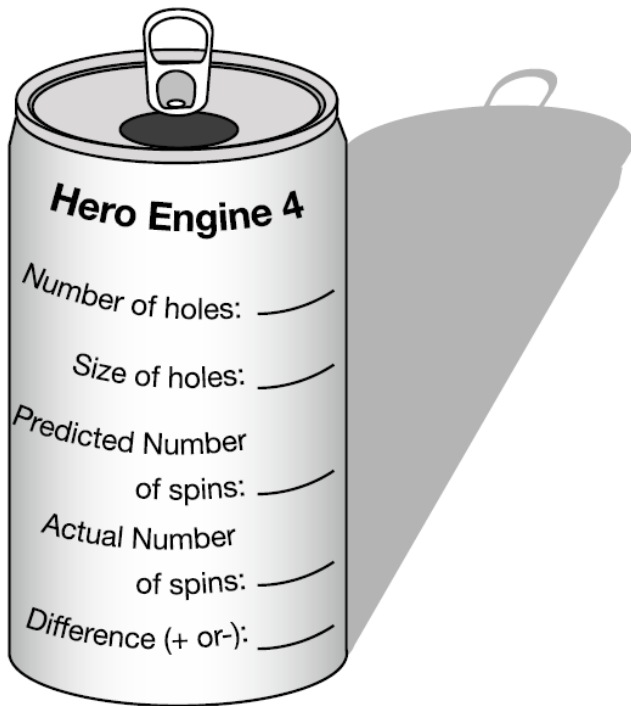

Did your new Hero Engine out-perform the original engines you built? \_\_\_\_\_

---

---

---

---

What did you learn about Newton's laws of motion by building and testing Hero Engines?

---

---

---

# Rocket Activity

## 3...2...1...PUFF!

### Objective

Students will learn about rocket stability as they construct and fly small paper rockets.

### Description

Students will construct small “indoor” paper rockets, determine their flight stability, and launch them by blowing air through a drinking straw.

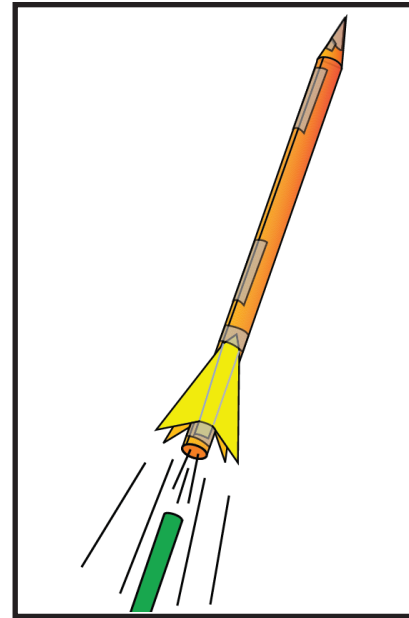

### Materials

- Sheet of 8.5 x 11 paper (white or colored)
- Cellophane tape
- Scissors
- Ruler
- Meter stick or tape measure
- Fat, round pencil or dowel (see tip, pg. 45)
- Eye protection
- Drinking straws
- Copy of the SLS paper rocket plans

### Management

Hold on to the straws until students have completed their rockets and tested them for stability. Select a clear space for the launches. Depending upon student lung power, rockets may fly 7-10 meters. Be sure students wear eye protection. Although the rockets have little mass, pointed nose cones could injure eyes. Make sure students understand that the rockets are not to be launched toward anyone.

### Background

Rocket stability is an important issue for rocket scientists. The success of a space launch depends upon “pinpoint” accuracy. If a future SLS rocket does not launch its payload into the correct orbit, it could jeopardize the mission.

### National Science Content Standards

- Unifying Concepts and Processes
  - Evidence, models, and explanation
- Science as Inquiry
  - Abilities necessary to do scientific inquiry
- Physical Science
  - Position and motion of objects
  - Motions and forces
- Science and Technology
  - Abilities of technological design

### National Mathematics Content Standards

- Number and Operations
- Geometry
- Measurement
- Data Analysis and Probability

### National Mathematics Process Standards

- Connections
- Representations



Stability means making sure the rocket follows a smooth path in flight. If it wobbles, the ride will be rough and extra fuel will be burned to get back on course. If it tumbles, it's time to push the destruct button! An unstable rocket is dangerous.

Fortunately, it is relatively easy to ensure stability when traveling through the atmosphere if two things are kept in mind. These two things are center of mass and center of pressure.

Center of mass (COM) is easy to demonstrate. It is the balance point of a rocket. Think of it like balancing a meter stick on an outstretched finger. If the stick rests horizontally, the COM is directly over your finger. If the COM is to the right of your finger, the stick will tip to the right. If to the left of your finger, the stick will tip to the left.

An object, tossed into the air, rotates around its COM. Rockets also try to rotate around their COM while in flight. If this rotation is allowed to happen, the rocket becomes unstable. This is where center of pressure (COP) comes to the rescue.

COP is also a balance point. It is the balance point of the pressure exerted on the rocket surface by air molecules striking it as it flies through the air. Like COM, there is a midpoint for the air pressure on the rocket body. This is the COP. For a stable rocket, the COP is located to the rear of the rocket and the COM is to the front. To understand why the rocket is stable, let's take a look at a couple of devices that also depend upon the placement of COM and COP.

A weather vane pivots on a vertical axis (COM) when the wind blows. One end of the vane is pointed and the other end has a broad surface. When the wind blows, the broad end of the vane catches more air (more air pressure) and is blown downwind. The narrow end of the vane has less pressure exerted on it and points into the wind.

One end of an arrow is long, narrow, and pointed while the other end has large feathers (or plastic fins). In flight, greater air pressure is exerted on the feathers than on the narrow end. This keeps the arrow from tumbling around its COM and on course to its target.

In both examples, there was more surface area on one side of the COM than on the other. Both devices were stable. Stability of a rocket is the same thing.

In this activity, students will build paper rockets and test them for stability using a drop test. Later activities will further explore the COM/COP concept and employ an advanced string test for rocket stability.

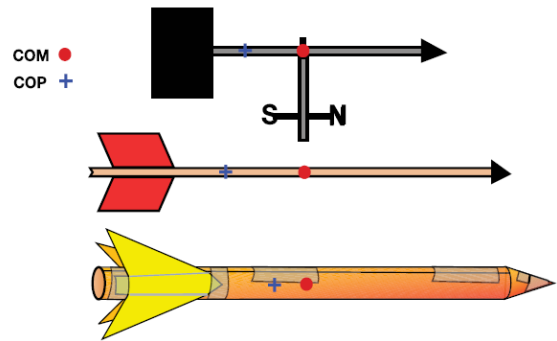

The positions of center of mass (red dot) and center of pressure (blue +) are shown for a weather vane, arrow, and rocket. The center of pressure is to the rear of the center of mass in each device. This enables them to point into the wind.

## Procedure

### First Activity

1. Demonstrate the construction technique for making paper rockets. (Refer to the diagrams on the next page.)
  - a. Cut a strip of paper for the rocket body (about 4 cm wide by 28 cm long).
  - b. Use a round pencil as a form and roll the strip around the pencil.
  - c. Tape the long seam.
  - d. Close off one end to make a nose cone.
  - e. Cut out three or four fins.
  - f. Tape the fins to the open (lower) end of the rocket. Bend them outward to space them equally.

2. After students have constructed their rockets, show them how to perform drop tests to check for stability. Hold the rocket horizontally at eye level and drop it to the floor. If the nose of the rocket hits the floor first, the rocket is stable and ready for flight. If the rocket falls horizontally or the fin end hits first, the rocket is unstable. Larger fins may be needed to stabilize the rocket. Have students perform their own stability tests and make adjustments to their rockets if needed.

3. Finally, demonstrate the launch procedure for the rocket. Stand at one end of your launch range. Insert a straw into the rocket body. Aim the rocket down range and puff strongly into the straw. Liftoff!

4. Talk over ideas for safety. Discuss wearing safety glasses. Ask students what should be done when they retrieve their rockets for another launch. (Other students should wait until the range is clear before launching).

5. Have students improve their rocket design by holding distance trials. Students will launch their rocket three times and find the average distance the rocket travels. They will then try to improve their rocket design to get greater distance. The student data sheets outline the procedures and provide space to jot down and analyze data.

### Rolling Rocket Tubes

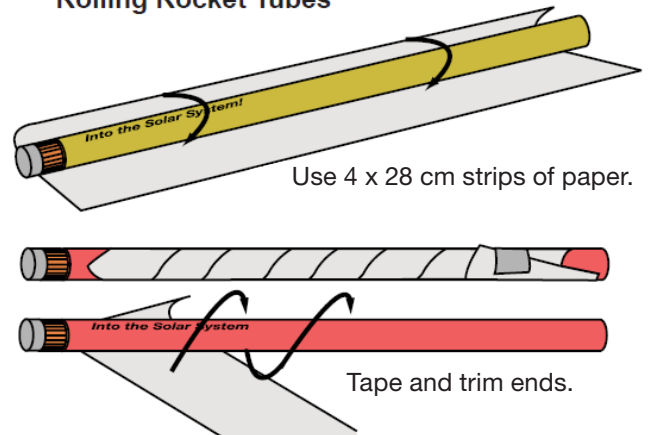

### Making Nose Cones

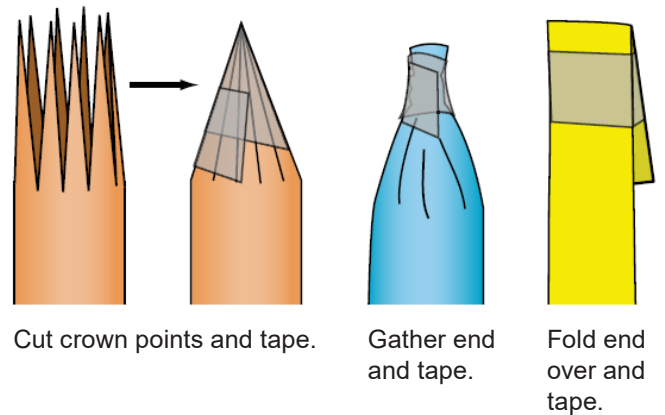

### Making and Attaching Fins

Cut tabs and spread.  
Tape tabs to rocket tube.

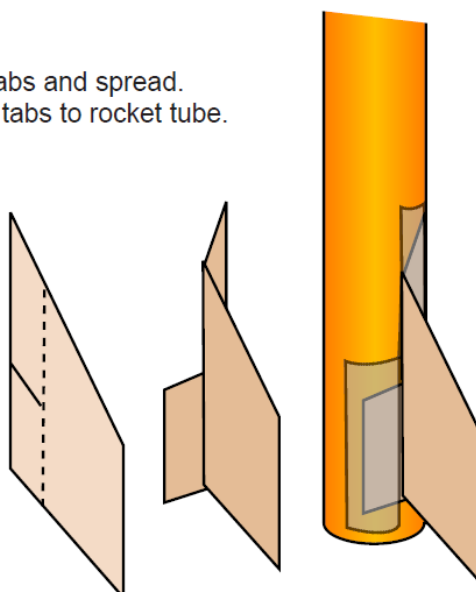

Fold paper square. Cut out fins. Spread fins and tape to rocket tube. Bend fin tips outward.

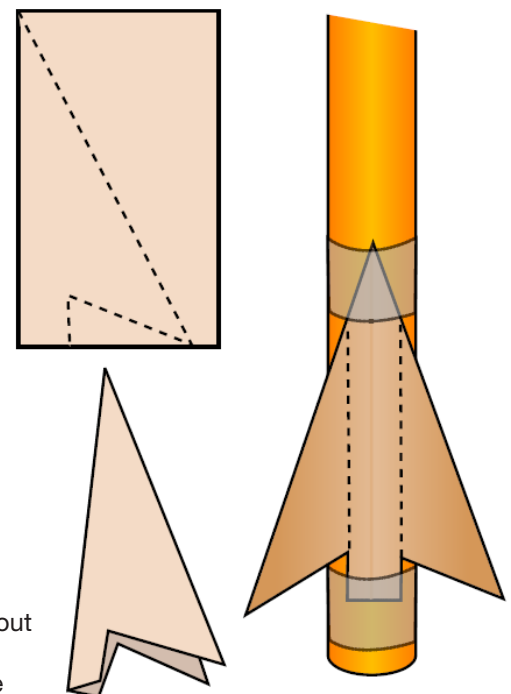

## Procedure

### Second Activity

1. Give students SLS rocket patterns to assemble. Two different patterns are provided, one for thin pencils or dowels and one for fat pencils and dowels. (These rockets do not have any fins. The actual SLS rocket uses steerable rocket engines to keep the rocket stable in flight.) After forming the rocket body, the upper end of the tube is folded four times and taped.

2. Before flying these rockets, have students repeat the stability drop test.

### Discussion

- *Why is the SLS rocket stable even though it doesn't have any fins?*  
Folding the paper makes the nose cone end of the rocket heavier than the tail end. Run a balance test with a finger. The balance point (center of mass) is far forward. The center of pressure is to the rear. This combination stabilizes the rocket for flight. The stability control for the paper version of the SLS rocket is similar to the control used by the Chinese for their fire arrows (See pictorial history section.) The actual SLS rocket will employ steerable engines to maintain stability.
- *How do paper rockets work?*  
Unlike traditional rockets, paper rockets do not carry their own propellants. Instead, a sharp puff through the straw momentarily fills the rocket tube with "high pressure" air. The tube directs the air back through the opening, producing an action force. The rocket launches because of the equal and opposite reaction force (Newton's third law).

### Assessment

- Have students write and illustrate a paragraph that describes their improvements to their rockets and how these improvements affected their experimental results.

## Extensions

- Have students investigate fin size and placement for its effect on flight stability.
- What will happen if the fins are placed at the nose end of the rocket? What will happen if the fin tips are bent pinwheel fashion? (Don't forget to perform drop tests before the actual flights!).
- Hold a rocket flight contest. See whose rocket flies the furthest or whose rocket is the most accurate (make a target).
- In a gym or other room with a high ceiling, launch rockets straight up next to a wall. Have other students estimate the altitudes reached by the rockets. Count the number of concrete blocks the rocket reached and multiply by the height of one block.
- Place a target at the far end of the launch range. An empty box makes a good target and rockets that land within the box are a "bull's eye."

**Tip** Segments of a 1/4" or 3/8" dowel can be substituted for fat pencils. Cut the dowels slightly longer than the paper strips. The extra length makes rolling the tubes easier.

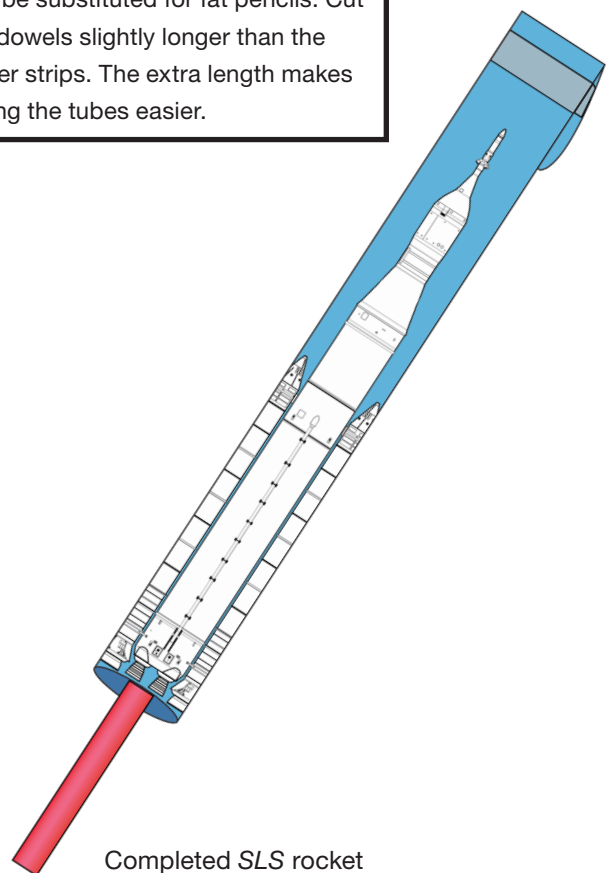

# Paper Rocket Test Report

Name: \_\_\_\_\_

1. Launch your rocket three times at the same launch angle. Each time, measure how far it flew. Record your measurements in the data sheet below, under the space labeled "Rocket 1." Calculate the average distance for the three flights.

2. *What can you do to improve the distance your rocket travels? Can you think of any improvements for your rocket?* Design and build a new rocket. Predict how far it will fly. Record your answer below in the space labeled "Rocket 2." Launch your second rocket three times and measure its distance. Record your data below. What is the difference between your predicted and actual distance? Did Rocket 2 fly farther than Rocket 1? Write your answers below.

3. *Did your changes in the rocket improve its flight?* Design and build a third rocket. Fly it the same way you did for Rockets 1 and 2. Did Rocket 3 fly farther than Rocket 2?

4. On the back of this paper, write a short paragraph describing the improvements you made to your rockets, how well they flew, and what you can conclude from your experiments. Draw pictures to illustrate how each rocket looked.

<p><b>ROCKET 1</b>      Flight Distance (in cm)</p> <table style="margin-left: auto; margin-right: auto;"> <tr><td style="padding-right: 10px;">Flight 1</td><td style="border: 1px solid black; width: 50px; height: 25px;"></td></tr> <tr><td style="padding-right: 10px;">Flight 2</td><td style="border: 1px solid black; width: 50px; height: 25px;"></td></tr> <tr><td style="padding-right: 10px;">Flight 3</td><td style="border: 1px solid black; width: 50px; height: 25px;"></td></tr> <tr><td style="padding-right: 10px;">Average Distance</td><td style="border: 1px solid black; width: 50px; height: 25px;"></td></tr> </table>	Flight 1		Flight 2		Flight 3		Average Distance		<p>Make notes about the flights here.</p>
Flight 1									
Flight 2									
Flight 3									
Average Distance									

<p><b>ROCKET 2</b>      Flight Distance (in cm)</p> <table style="margin-left: auto; margin-right: auto;"> <tr> <td style="padding-right: 10px;">Distance Prediction</td> <td style="border: 1px solid black; width: 50px; height: 25px;"></td> <td style="padding-right: 10px;">Flight 1</td> <td style="border: 1px solid black; width: 50px; height: 25px;"></td> </tr> <tr> <td></td> <td></td> <td style="padding-right: 10px;">Flight 2</td> <td style="border: 1px solid black; width: 50px; height: 25px;"></td> </tr> <tr> <td style="padding-right: 10px;">Difference between your prediction and the average flight distance</td> <td style="border: 1px solid black; width: 50px; height: 25px;"></td> <td style="padding-right: 10px;">Flight 3</td> <td style="border: 1px solid black; width: 50px; height: 25px;"></td> </tr> <tr> <td></td> <td></td> <td style="padding-right: 10px;">Average Distance</td> <td style="border: 1px solid black; width: 50px; height: 25px;"></td> </tr> </table>	Distance Prediction		Flight 1				Flight 2		Difference between your prediction and the average flight distance		Flight 3				Average Distance		<p>Make notes about the flights here.</p>
Distance Prediction		Flight 1															
		Flight 2															
Difference between your prediction and the average flight distance		Flight 3															
		Average Distance															

<p><b>ROCKET 2</b>      Flight Distance (in cm)</p> <table style="margin-left: auto; margin-right: auto;"> <tr> <td style="padding-right: 10px;">Distance Prediction</td> <td style="border: 1px solid black; width: 50px; height: 25px;"></td> <td style="padding-right: 10px;">Flight 1</td> <td style="border: 1px solid black; width: 50px; height: 25px;"></td> </tr> <tr> <td></td> <td></td> <td style="padding-right: 10px;">Flight 2</td> <td style="border: 1px solid black; width: 50px; height: 25px;"></td> </tr> <tr> <td style="padding-right: 10px;">Difference between your prediction and the average flight distance</td> <td style="border: 1px solid black; width: 50px; height: 25px;"></td> <td style="padding-right: 10px;">Flight 3</td> <td style="border: 1px solid black; width: 50px; height: 25px;"></td> </tr> <tr> <td></td> <td></td> <td style="padding-right: 10px;">Average Distance</td> <td style="border: 1px solid black; width: 50px; height: 25px;"></td> </tr> </table>	Distance Prediction		Flight 1				Flight 2		Difference between your prediction and the average flight distance		Flight 3				Average Distance		<p>Make notes about the flights here.</p>
Distance Prediction		Flight 1															
		Flight 2															
Difference between your prediction and the average flight distance		Flight 3															
		Average Distance															

# SLS Rocket Pattern for 3/8th inch dowel or fat pencils

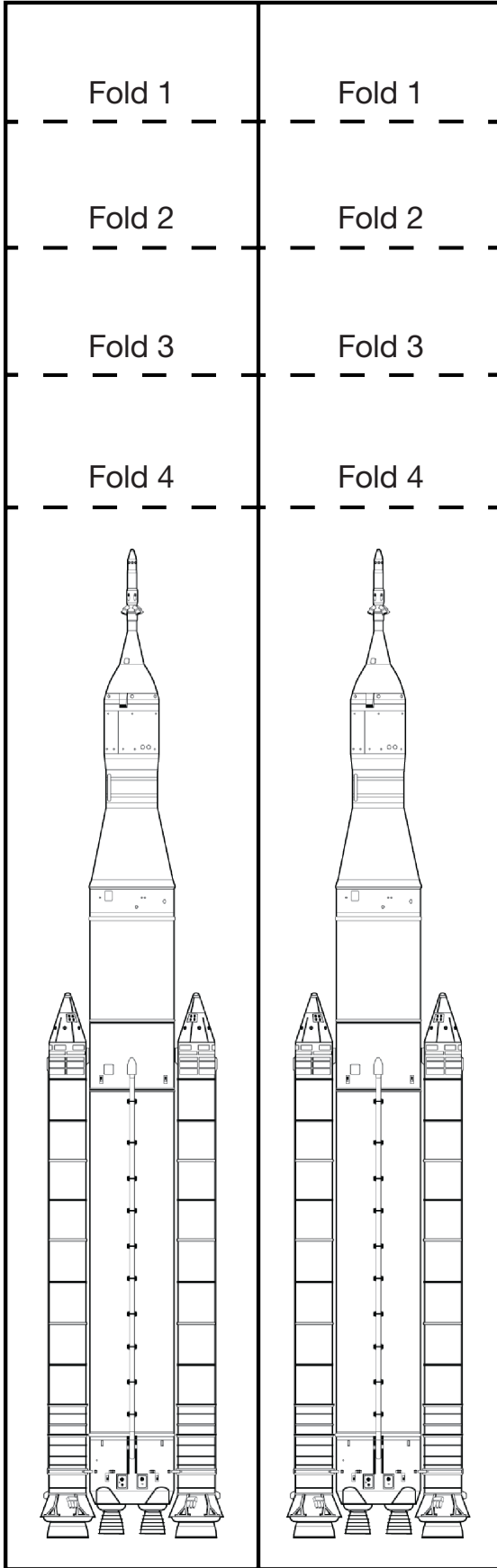

# SLS Rocket Pattern for 1/4 or 5/16th inch dowel or standard pencils

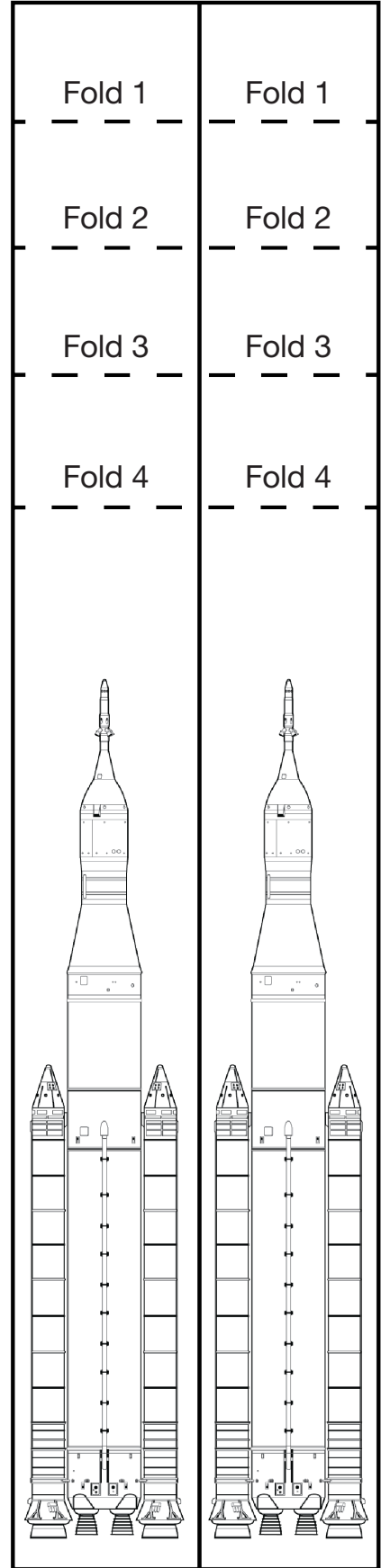

# Rocket Activity

## Heavy Lifting

### Objectives

Students construct balloon-powered rockets to launch the greatest payload possible to the classroom ceiling.

### Description

Student teams receive identical parts with which they construct their rockets. Drinking straws guide balloon rockets up strings suspended from the ceiling. Teams compete to launch the greatest number of paper clips to space (ceiling).

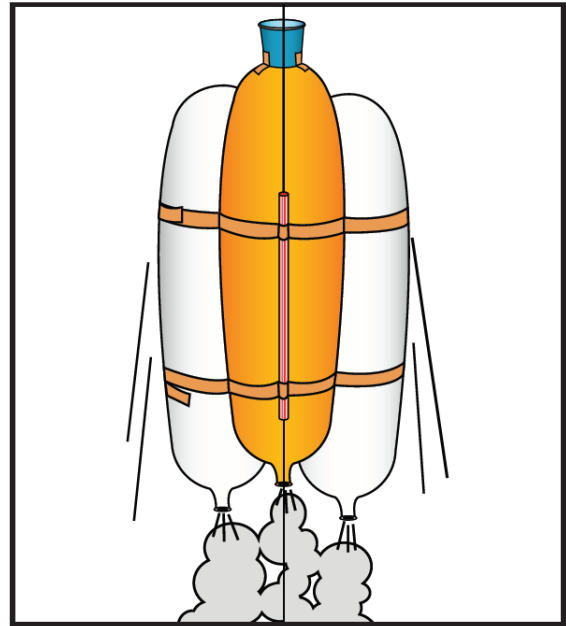

### Materials

- Large binder clips (one per launch pad)
- Fishing line or smooth string
- Long balloons (see note on next page about sources)
- Bathroom size (3 oz) paper cup
- 2 straight drinking straws
- 50 small paper clips
- Sandwich size plastic bag
- Masking tape
- Balloon hand pumps (optional)
- Wooden spring-type clothespins (optional)

### Management

Prepare your classroom by setting up “launch pads” consisting of pieces of fishing line or string suspended from the ceiling (one line per team of students). If your classroom has a suspended ceiling, use binder clips or clothes pins to attach to the metal frame supporting the ceiling tiles. Tie the fishing line to the clip or pins. Make sure the line is long enough to reach the floor. Provide open working space around each launch pad.

### National Science Content Standards

#### Science as Inquiry

- Abilities necessary to do scientific inquiry

#### Physical Science

- Position and motion of objects
- Motions and forces

#### Science and Technology

- Abilities of technological design

### National Mathematics Content Standards

- Number and Operations
- Data Analysis and Probability

### National Mathematics Process Standards

- Problem Solving
- Reasoning and Proof
- Communication
- Connections
- Representations

Explain how the straw is used for guiding the rockets. The fishing line or string is fed through the straw and one or more balloons are attached to it with masking tape. When the balloon is released, the straw will ride up the line. Stress that it is very important for students to hold the lower end of the line to the floor. If there is slack in the line or if the lower end of the line is free, the rocket will waffle about and not reach the ceiling. If you have balloon pumps, demonstrate how they are used to inflate the balloons.

Avoid providing too much information for the students. This is an exercise in creativity, skill, and problem solving. Simply explain the activity, how to use the straws for stability, and tell them that they can use any or all of the parts in their supply kits to build and fly their rockets. The supply kits contain three balloons. Remind students that they only get three balloons.

## Balloon Sources

Many party supply stores carry variety packs that may include long balloons. Ask if they will special order packs of long balloons for you. The balloons become cylinders 5 inches in diameter and 24 inches long when inflated. They are sometimes called 524 (5 by 24 inches) airships. Find manufacturers and distributors by searching “524 balloons” on the Internet.

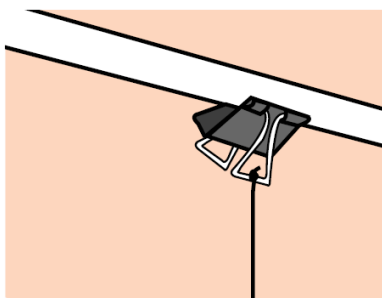

Binder clip attached to ceiling grid.

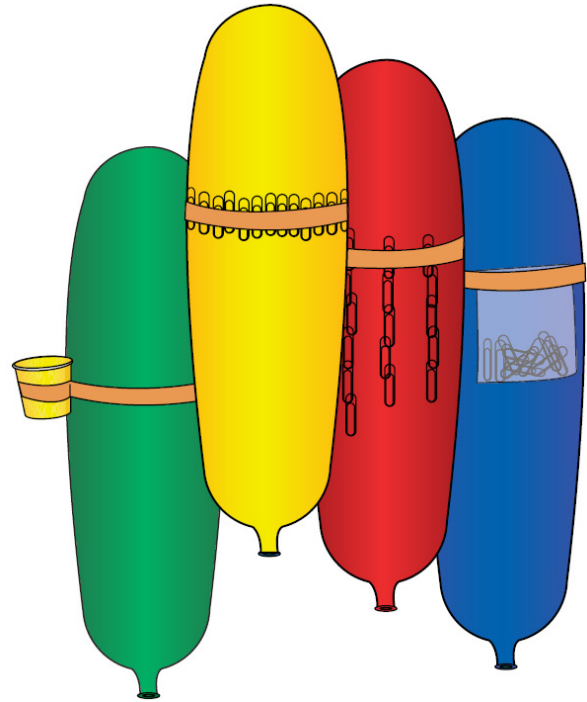

Some different ways students may devise to carry the paper clips. The plastic bag can be used too. Let teams come up with their own ideas.

## Background

NASA’s Artemis program for lunar exploration includes a heavy lift rocket called the Space Launch System (SLS) [see pages 14 – 18 for a detailed description of the rocket]. SLS will be able to launch heavy payloads into orbit, such as very large telescopes and scientific instruments, and the Orion spacecraft that will propel humans to the Moon and, eventually, Mars.

Raising heavy payloads to orbit is challenging. Rockets require powerful engines and massive amounts of propellant. NASA’s SLS will be able to accomplish the job. It will have unprecedented power and capabilities. Offering more payload mass, volume capability, and energy to speed missions through space, SLS will open new possibilities for missions beyond Earth.

## Procedure

1. Divide your students into teams of three. Explain the project to them.

“NASA is looking for creative ideas for launching heavy payloads into orbit. Payloads include parts and supplies for the International Space Station and spacecraft that will carry humans to the Moon and Mars. NASA is also interested in rockets that can transport large fuel tanks that will be used to power deep space rockets. You are challenged to build the most efficient heavy lift rocket from the same set of materials. The team that is able to lift the greatest payload into space (the ceiling) is the winner.”

2. Provide each team with an identical kit of materials. Tell them that any or all of these materials can be used for their rockets.

3. Review the launching procedure. Explain how the straw guides the rocket up the fishing line or string and that the line must be held snug to the floor for the launch. Remind the teams that they only get three balloons. They can launch as many times as they want to but should try to improve how many paper clips they can successfully lift.

4. Draw a chart on the board for teams to record their results (i.e., the number of paper clips that reach the ceiling).

**Tip** If you wish to do so, provide one extra balloon to each team as a replacement in case of a mishap (pop!) or as a fourth rocket for their cluster. Make a small coupon for the extra balloon and put it in the parts bag. The coupons will help you keep track of which teams have already requested an extra balloon.

## Discussion

- *Why is it important to construct efficient heavy lift vehicles?*

Traveling into space is a very difficult and expensive endeavor. Huge rockets and tremendous amounts of propellants are required to accomplish the job. With some rockets, launch costs were approximately \$20,000 per kg of payload delivered into Earth orbit. If that cost were to continue, imagine staying at a space hotel where it would cost about \$10,000 for a half liter bottle of drinking water! Improving heavy lift rockets (lighter rocket structures, more propellant efficient engines, etc.) will enable us to accomplish much more in space at far more reasonable costs!

**Tip** Occasionally, a balloon will have a tiny pinhole that will prevent it from being inflated or from holding air very long. Keep a small supply of replacement balloons.

## Assessment

- Have each team describe their design to the class.
  - How many balloons did they use?
  - How many paperclips did their rocket carry to the ceiling?
  - How did they attach the paperclips to the balloon?
  - What problems did they encounter?
  - How did they solve those problems?
- Write a summary of your launch vehicle using correct science and technology terms (e.g., lift, payload, mass, thrust).

## Extensions

- Challenge students to design a two-stage rocket. The lower balloon “fires” before the upper balloon. The upper balloon carries the payload to the ceiling.



# Heavy Lift Rocket Mission Report

Team Member Names: \_\_\_\_\_

Flight Test	Predict How Much Mass Your Rocket Will Lift <i>1 paper clip = 2 g</i>	Actual Mass Lifted
1.		
2.		
3.		
4.		
5.		

Make a sketch of your best rocket.

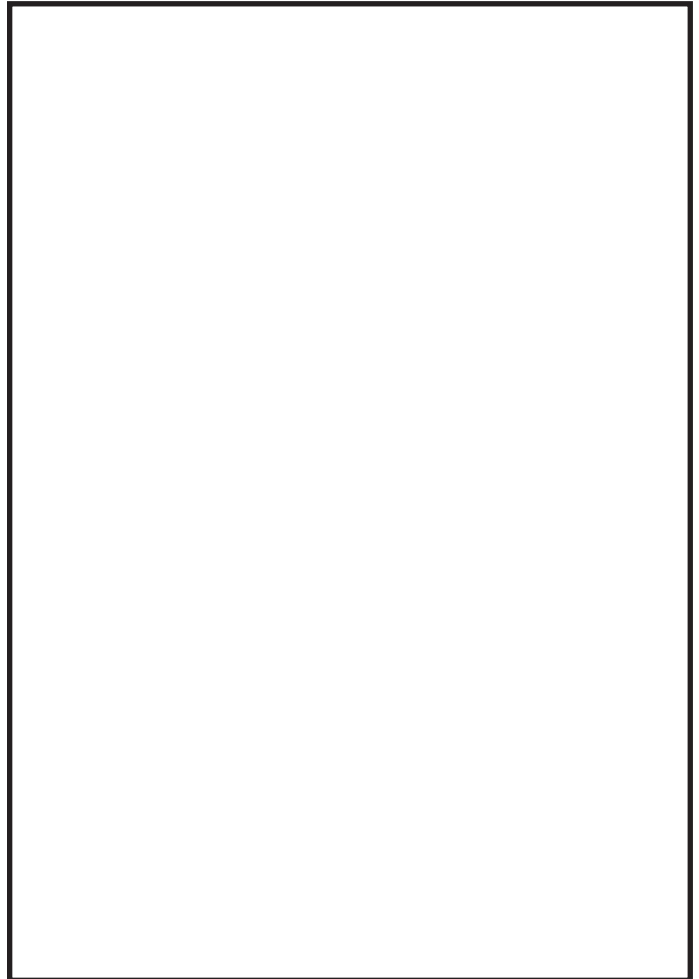

Describe your first rocket.

How did you change your rocket to make it carry more mass?

What other ways could you change your rocket to improve it?

# Rocket Activity

## Newton Car

### Objectives

To investigate the relationship between mass, acceleration, and force as described in Newton's second law of motion.

### Description

Small student teams use a wooden car and rubber bands to toss a small mass off the car. The car, resting on rollers, will be propelled in the opposite direction. During a set of experiments, students will vary the mass being tossed from the car and change the number of rubber bands used to toss the mass. Students will measure how far the car rolls in response to the action force generated.

### Materials

- Newton Cars (see separate instructions)
- Cotton string
- Two rubber bands (size 19)
- Medicine bottles (see Tip)
- 25 straight drinking straws (not flex)
- Meter stick or ruler
- Metric beam balance or scale Scissors or lighters (see Management below)
- Popcorn seeds, washers, pennies, marbles, paper clips, etc. (for filling the bottles)
- Eye protection

### Management

This activity requires a smooth floor or long tables for a rolling surface. Be sure teams understand how to set up the car and are consistent in their placement of straws. Demonstrate the "loading" of the car. After attaching the rubber band and string to the car, press the bottle into the "V" of the rubber bands. This process must be done the same way each time. Also demonstrate the string cutting process. The string must be cut and the

scissors moved out of the way in one smooth and quick movement. Lighters can also be used for burning through the string. Have students light the ends of the string dangling down from the knot. The flame will climb up the strings and burn through the knot. Students must wear eye protection with either string cutting technique.

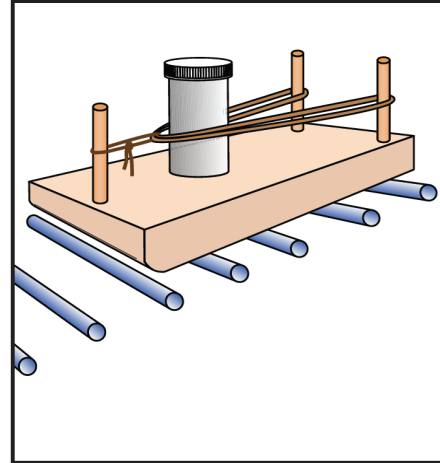

### National Science Content Standards

Unifying Concepts and Processes

- Evidence, models, and explanation
- Change, constancy, and measurement

Science as Inquiry

- Abilities necessary to do scientific inquiry

Physical Science

- Position and motion of objects
- Motions and forces
- Properties of objects and materials

Science and Technology

- Understanding about science and technology

### National Mathematics Content Standards

- Number and Operations
- Measurement
- Data Analysis and Probability

### National Mathematics Process Standards

- Problem Solving
- Reasoning and Proof
- Communication
- Connections
- Representations

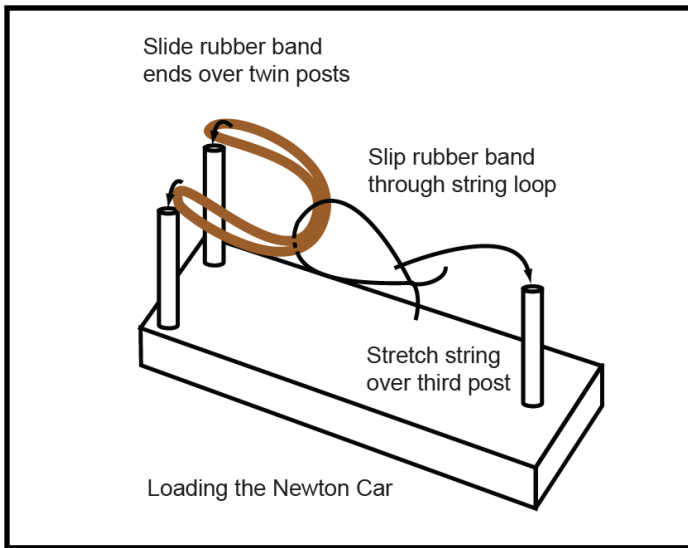

## Background

Although the purpose of the Newton Car is to investigate Newton's second law of motion, it provides an excellent demonstration of all three laws. The car is a slingshot-like device. Rubber bands are stretched between two posts and held with a string loop ringing a third post. A bottle, holding various materials that can be changed to vary its mass, is placed between the stretched rubber bands. When the string is cut, the bottle is tossed off the car and the car travels the other way on straw rollers.

Newton's first law is demonstrated by the act of exerting a force. The car remains at rest until the mass is expelled, producing a force. The car then moves. The action force exerted on the car produces an equal and opposite reaction force. The car moves the other way from the tossed bottle. This demonstrates Newton's third law.

How far the car moves demonstrates the second law. The magnitude of the force is determined by how much mass is tossed and how fast it is accelerated off the car.

By varying the mass and the number of rubber bands, students are able to see a visual demonstration of the relationship of mass and acceleration on force. The greater the mass of the bottle and its contents

and the greater the acceleration (more rubber bands), the greater the force. The effect is that the car will travel further in the opposite direction. (Refer to pages 21 – 25 for a more detailed explanation of Newton's laws of motion.)

## Materials

- 1 1 X 3 X 8 in. board\*
- 3 1/4" diameter by 2 1/2" long dowels (or wood screws)
- Wood glue

## Procedure

### Making Newton Cars

1. Cut the board into 12 8 in. lengths. (Optional: Bevel one edge as shown on the previous page.)
2. Drill three 1/4 in. holes 3/8 in. deep for the dowels. If using screws for posts instead of dowels, skip Step 3.
3. Glue the dowels into the holes. If desired, bevel the upper end of the dowels with sand paper.

\* Note: Dimensions of lumber are based on rough cuts. When planed, thickness and width are smaller. A 1X3-in. board is actually 0.75 by 2.5 in.

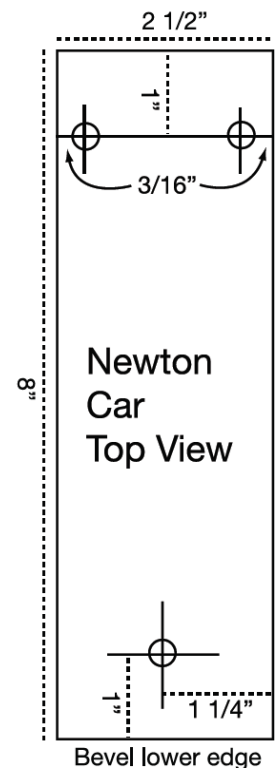

## Procedure

### The Experiment

1. Provide student teams with the instruction sheet on how to set up the Newton Car and the data sheet.
2. Clear areas for each team to set up their experiment.
3. Provide a station where teams can fill their bottles with different materials to change their total mass. Place the popcorn seeds, washers, etc., in different bowls for easy access. The bottles do not have to be filled to the top. However, the rubber bands should be positioned around the approximate center of mass of the bottle to get a uniform toss.
4. Check each team to ensure they are being consistent in their procedures. For instance, placing straws differently for each test would introduce a new variable into the experiment that could affect the results.

**Tip** Provide masking tape so that students can use small tape pieces to mark the positions of the straws for consistency.

### Discussion

- How does adding additional rubber bands change the acceleration?

Like all matter, the bottle has inertia, which is the property of resistance to change in motion. Newton's first law of motion is often referred to as the law of inertia. A force is needed to change the motion of the bottle. In this experiment the inertia of the bottle retards the contraction of the rubber band. Two rubber bands, working together, are able to contract more rapidly and consequently are able to impart a greater acceleration to the bottle.

**Tip** Ask a pharmacist for a donation of new, 8-dram size medicine bottles.

## Assessment

- Review the experiment report for completeness and check team statements, explaining the relationship between mass, acceleration, and the distances the Newton Cars traveled.
- Ask students for other examples of Newton's laws of motion at work.

## Extensions

- Newton's second law of motion can also be demonstrated using a water rocket. Vary the pressure in the water rocket by using different numbers of pumps. Vary the amount of water inside the bottle. Changes in mass and acceleration will affect the performance of the rocket in flight.

# Heavy Lift Rocket Mission Report

1. Tie six string loops approximately this size.



2. Fill the plastic bottle with small weights provided by your teacher. Measure the mass of the filled bottle and record the amount on your data sheet for test 1.

3. Set up your Newton Car as shown in the picture. Slide the rubber band through the first string loop. Slip the ends of the rubber band over the two posts. Pull the string back to stretch the rubber bands, and slip the loop over the third post to hold the loop.

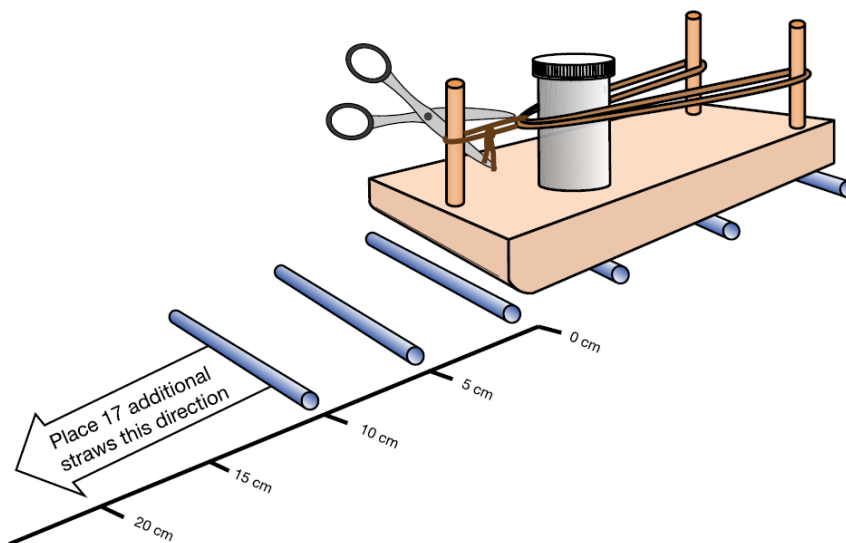
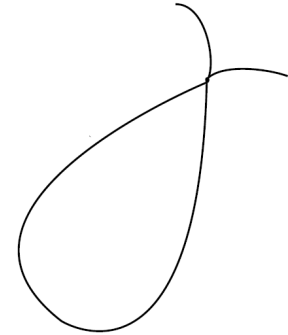

4. Lay the straws on a smooth floor or tabletop. Place them like railroad ties 5 cm apart. Put the Newton Car on top of the straws at one end of the line.

5. Using the scissors, cut the string. Quickly move the scissors out of the way! The rubber band will toss the bottle off the Newton Car while the car rolls the other way on the straws.

6. Measure how far the Newton Car moved and record the distance on the data sheet.

7. Repeat the experiment using two rubber bands. Be sure to set up the straws and place the Newton Car on them exactly as before. Record your data.

8. Put different weights in the bottle and measure its mass. Record the mass and repeat the experiment with one and two rubber bands. Record your data.

9. Once more, put different weights in the bottle and measure its mass. Record the mass and repeat the experiment with one and two rubber bands. Record your data.

10. Answer the questions on the data sheet and write a general statement about the relationship between the mass and number of rubber bands used and the distance the Newton Car travels.

# Newton Car Experiment Report

Team Member Names: \_\_\_\_\_

	Mass of Bottle	Number of Rubber Bands	Distance Car Traveled
Test 1		1	
		2	
Test 2		1	
		2	
Test 3		1	
		2	

Did the number of rubber bands affect how far the Newton Car moved? Describe what happened.

---



---



---



---



---

Did the mass of the bottle affect how far the Newton Car moved? Describe what happened.

---



---

Construct a bar graph showing how far the Newton Car moved for each test.

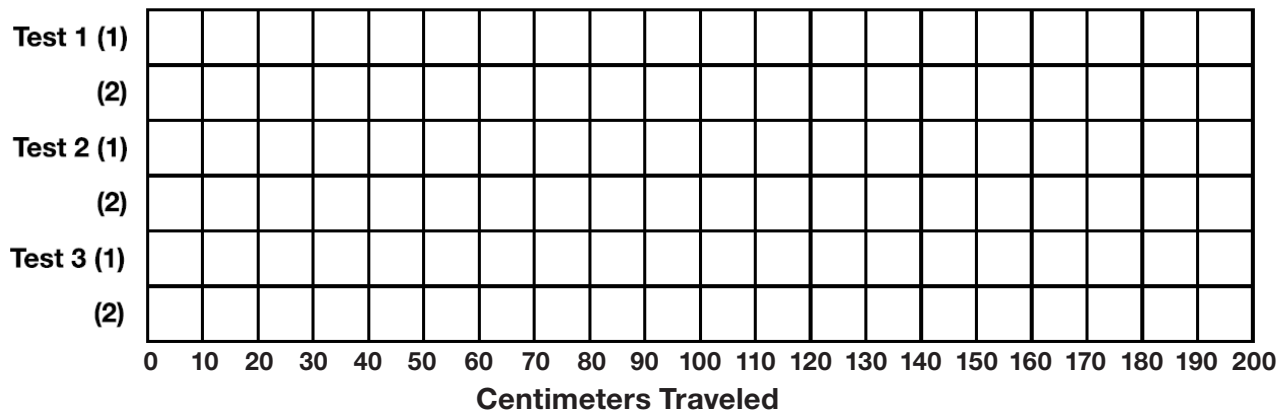

On the back of this page write a short statement explaining the relationship between the amount of mass in the bottle, the number of rubber bands used, and the distance the Newton Car traveled.

# Rocket Activity

## Rocket Races

### Objectives

Students investigate Newton's third law of motion by designing and constructing rocket powered racing cars.

### Description

Individual students construct racing cars from Styrofoam food trays and power them with the thrust of an inflated balloon. In three racing trials, the racers shoot along a straight course, and the distance the racers travel is measured. Between trials, students redesign their racers to improve their performance and solve any "mechanical" problems that crop up. At the conclusion of the activity, students submit a detailed report on their racer design and how it performed in the trials.

### Materials

- Styrofoam food trays (ask for donations from local supermarkets)
- Small plastic stirrer straws (round cross section) - 2 per racer
- Flexi-straws - 3 per racer 4 - or 5-inch round balloon
- Masking tape
- Sharp pencil
- Scissors (optional)
- Ruler
- Meter stick or metric measuring tape for laying out race course
- Sandpaper (optional)

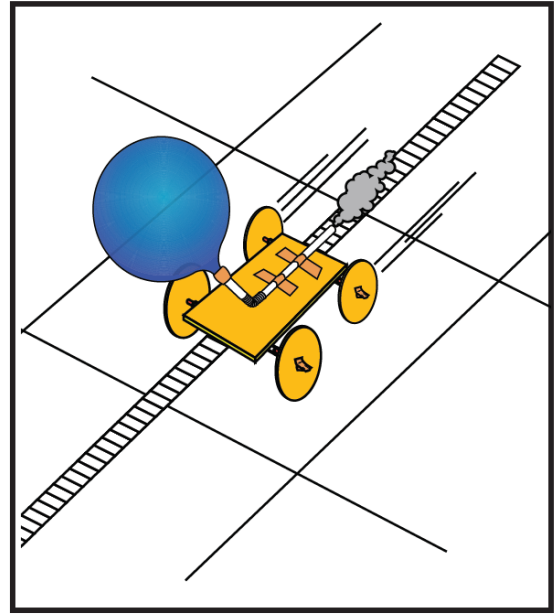

### National Science Content Standards

Unifying Concepts and Processes

- Change, constancy, and measurement
- Science as Inquiry
- Abilities necessary to do scientific inquiry

Physical Science

- Position and motion of objects
- Motions and forces

Science and Technology

- Abilities of technological design

### National Mathematics Content Standards

- Number and Operations
- Geometry
- Measurement
- Data Analysis and Probability

### National Mathematics Process Standards

- Problem Solving
- Reasoning and Proof
- Communication
- Connections
- Representations

### Management

Each student will need a Styrofoam food tray. Request donations from your local supermarket. Ask for thicker trays (about 3/16 in. thick). Yellow trays used for poultry work well. Waffle-bottom trays are acceptable. Although the trays can be cut using scissors, save the scissors for trimming.

It is much easier to score the Styrofoam with a sharp pencil and then break away the pieces. Score lines can be continuous or the tip of the pencil can be punched into the Styrofoam to make a dotted line. Demonstrate the scoring process to your students. After the pieces are broken out, the edges are smoothed. Wheels can be smoothed by rolling them on a hard surface while applying pressure. Sandpaper can also be used for smoothing.

Lay out a race course in a large open space or hallway. The space can be carpeted, but textured carpets interfere with the movements of the racers. Stretch out a 10 m long line of masking tape and mark 10 cm intervals. If you have a 10 m tape measure, just tape it to the floor.

Double check the taping of the balloon to the straw. The balloon should be completely sealed, or it will be difficult to inflate, and some of its thrust will be lost through the leaks. Pre-inflating the balloon will loosen it and make it easier to inflate through the straw.

Guide students through the redesign process to improve their racers. If their racers are not running well, ask them what they think the problem is. Then, ask them what they can do about it. Typical problems include having wheels too tight to the sides of the cars (friction), wheels or axles mounted crooked (racer curves off course), and axles not mounted in center of wheel or wheels not round (like “clown car” wheels).

## Background

The rocket racer is an excellent demonstration of Newton’s third law of motion. Air is compressed inside a balloon that is expanded. When the nozzle is released, the balloon returns to its original uninflated size by propelling the air out its nozzle. The straw mounted to the balloon extends the nozzle beyond the rear end of the car. The action force of the expelling air produces a reaction force that pushes the racer in the opposite direction. The racer’s wheels reduce friction with the floor, and the racer takes off down the race course.

Although the rocket racer seems simple, there are many challenging complexities in its operation. In principle (Newton’s second law of motion), the less mass the car has, the greater its acceleration will be. Generally, heavy rocket racers do less well than lighter racers. However, very small racers are limited by other factors. Vehicles with short wheel bases tend to circle or partially lift off the floor. Balance becomes a problem. The mass of the balloon may cause the car to tilt nose down to the floor, causing a poor start.

The engineering design of the racer is very important. Many designs are possible, including wide, narrow, and I-beam shaped bodies and three, four, or even six wheels.

Students will have to review the trade-offs of their design. For example, an extra-long body may provide a straighter path, but the car might travel a shorter distance as a result.

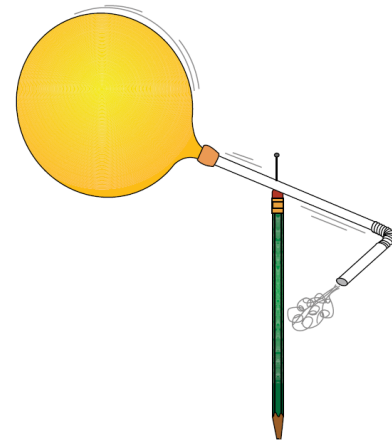

Demonstrate the action-reaction principle by inserting a pin through the straw and into a pencil eraser. Inflate the balloon, and it will pinwheel around the pencil as air rushes out. Compare this to the straight thrust produced by the balloon in the rocket cars.

## Procedure

1. Explain the activity to the students. Provide them with the How To Build A Rocket Racer Sheet. Go over the construction steps and demonstrate how to snap out parts, mount the wheels, and attach the straw to the balloon.



2. Stress that the racer shown in the instructions is a basic racer. Many designs are possible. Have them think of their own designs.
3. Review the Rocket Racer Data Sheet and make sure students know how to fill out the graphs and the data they should collect.
4. Distribute materials and lay out the racer course.
5. When student racers are ready, have one or two students at a time inflate their balloons and pinch off the end of the straw to keep the air inside. Have them place their racers just behind the starting line and release the straws. Regardless of how much curving a racer does, the measured distance is how far along the straight line of the race course the car reached.
6. Post distance records to motivate students to modify their racers to set new records.
7. After each racer runs three times, have students complete their data sheets and sketch their final design on the design sheets.

## Discussion

- *Would it be a good idea for automobiles to be powered by rocket engines?*  
If there was only one rocket powered automobile on the road, it would work fine. However, imagine rush hour traffic loaded with rocket cars. Each would blow exhaust gas at the vehicles to the rear.
- *How are the wheels on a rocket racer similar to and different from wheels on a regular automobile?*  
Rocket racer wheels reduce friction with the ground. They turn when the air coming from the balloon exerts a thrust. Wheels for an automobile also permit the car to roll across the ground, but the thrust of an automobile depends upon friction. The engine turns the wheels, and friction with the rubber and the pavement transmits the action force so that the car rolls forward.

## Assessment

- Review student Rocket Racer Data Sheets and Design Sheets.
- Have students write an explanation of Newton's third law of motion using their rocket racers as examples.

## Extensions

- Hold Rocket Racer drag races. Lay out a 3 m long course. The fastest car is the one that crosses the finish line first. Calculate racer average speed by timing start to finish with a stopwatch (e.g., four seconds to go three meters = 0.75 m/second or 2.7 kph).
- Have students try multiple balloons for additional thrust. How will students design cars that are balanced with the extra load?
- Have students control the thrust of their balloons by inflating them to the same diameter each time. How can students ensure that the balloon is always the same?
- Using the same materials, what other devices can be created that demonstrate the action-reaction principle of Newton's third law of motion?

# How to Build a Rocket Racer.

1. Lay out your pattern on the Styrofoam tray. You will need a racer body and wheels. Use a pencil point to score the Styrofoam. Snap out your pieces and smooth them. Make sure your wheels are round! Use sandpaper to round the wheels OR press them on a hard surface and roll them.

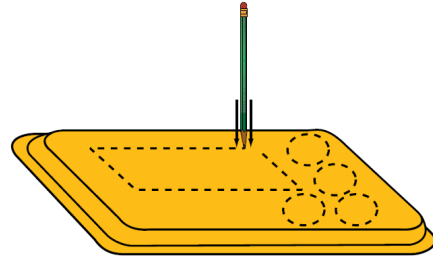

2. Punch a small hole in the center of each wheel with the pencil. Push the axle (stirrer) straw through the hole of one wheel so that it extends 1 cm on the other side. Pinch a piece of masking tape around the end of the straw and smooth it on to the wheel. Do the same for the second axle. Do not add wheels to the other ends yet!

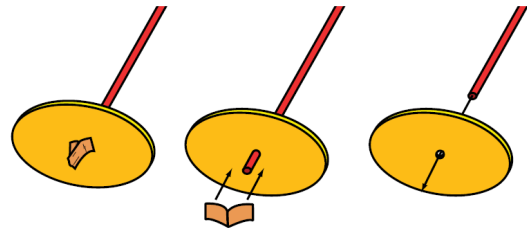

3. Cut two large straws to the size you want. Tape them parallel to each other on the bottom of the racer body at opposite ends. Slide a wheel and axle through one of the straws and mount a second wheel on the other end of the axle.

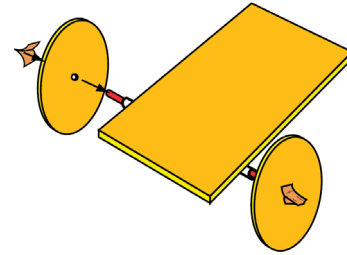

4. Slide the second wheel and axle through the remaining straw and mount the remaining wheel at its opposite end.

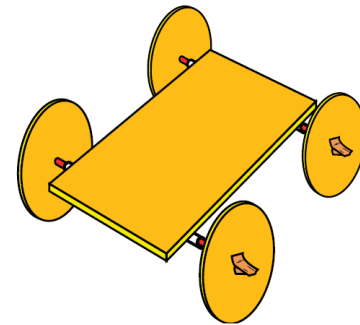

5. Blow up the balloon and then let the air out. Next, slip the straw into the balloon as shown. Use masking tape to seal the balloon nozzle to the straw. Squeeze the tape tightly to seal all holes. Test the seal by blowing up the balloon again through the straw.

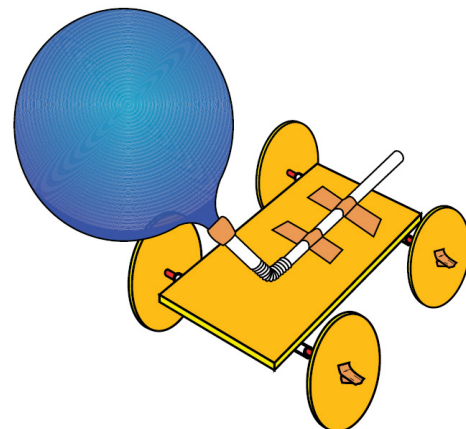

6. Mount the balloon and straw to the racer with masking tape as shown. Be sure the end of the straw (rocket nozzle) extends off the end of the racer body.

# Wheel Patterns

Cut out the desired wheel size. Trace the wheel outline on the Styrofoam. Punch the pencil point through the cross to mark the center.

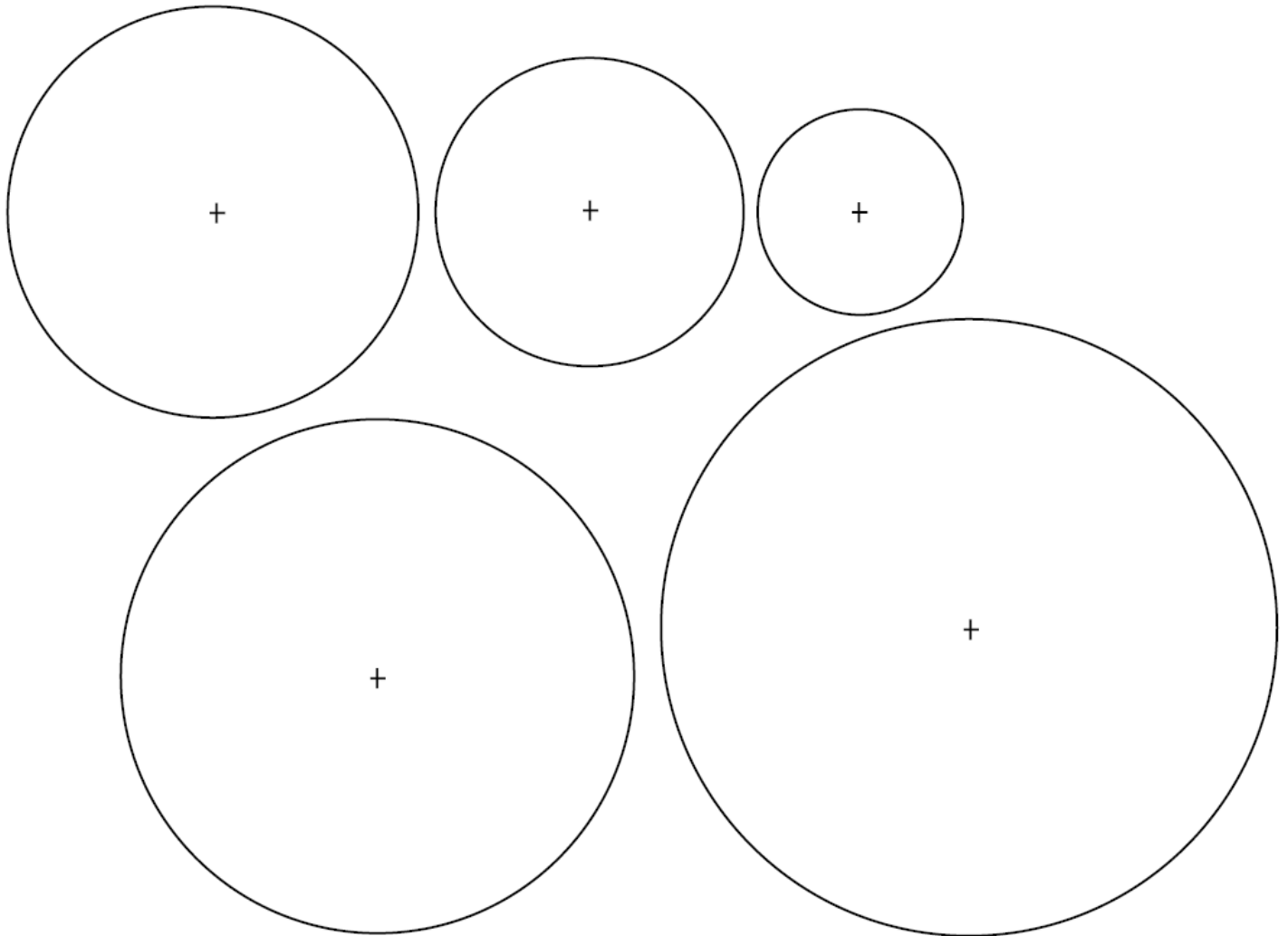



# Rocket Racer Data Sheet

Name: \_\_\_\_\_

## Rocket Racer Trial #1

*Shade in the graph showing how far your rocket racer traveled in centimeters.*

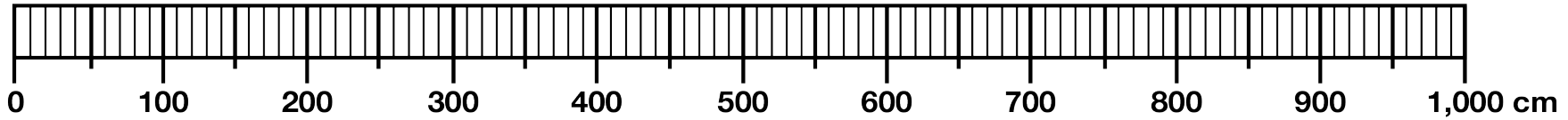

Describe how your rocket racer ran (straight, curved, circles, stuck, etc.).

Did your racer perform as well as you hoped? Explain why or why not.

## Rocket Racer Trial #2

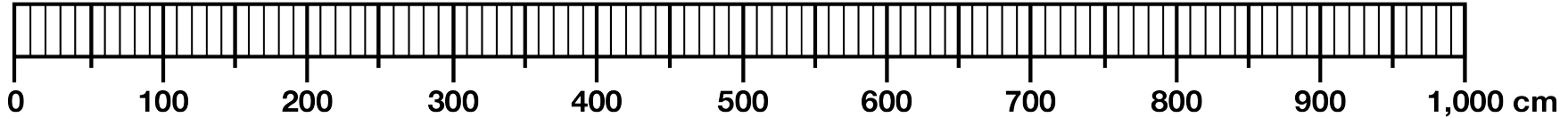

How did you improve your rocket racer?

Predict how far your racer will run. \_\_\_\_\_ cm

Describe how your rocket racer ran.

Did your improvements work? Explain why or why not.

## Rocket Racer Trial #3

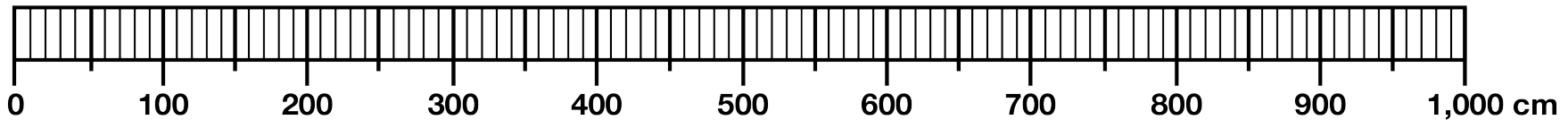

How did you improve your rocket racer?

Predict how far your racer will run. \_\_\_\_\_ cm

Describe how your rocket racer ran.

Did your improvements work? Explain why or why not.

# Rocket Activity

## Pop! Rocket Launcher

### Objectives

To construct a simple air pressure launcher for paper rockets.

### Description

Students stomp or jump on an empty 2-liter soft drink (“pop”) bottle and force the air inside through connected plastic pipes to propel a paper rocket.

### Materials

- Empty (and rinsed) 2-liter plastic soft drink bottle
- 2 1/2 in. PVC tee connectors
- 1 1/2 in. PVC connector
- 2 1/2 in. PVC caps
- 1 - 5' length of 1/2 in. PVC pipe
- Duct tape
- Ruler
- Optional: PVC cutter
- Eye protection for anyone near launcher



### National Science Content Standards

#### Physical Science

- Position and motion of objects
- Motions and forces

#### Science and Technology

- Abilities of technological design

### National Mathematics Content Standards

- Measurement

### National Mathematics Process Standards

- Connections

### Management

The Pop! Rocket Launcher, although fun for all students, is an ideal launcher for younger students because they love to stomp on the bottle to launch the rocket. The launcher can be used for any kind of large paper rocket. However, the Pop! Rockets described in the activity starting on page 68 are well-suited for this group of students because of their relatively easy construction.

Take the shopping list page 66 to the hardware store to obtain the PVC parts. The PVC pipe will be cut into smaller pieces. Use a fine-tooth saw or a PVC cutter (available from the hardware store).

The PVC parts do not have to be cemented together. Friction will hold the parts with occasional adjustments.

Leave the label on the bottle. This gives students a target to aim for when stomping. If the end of the bottle is accidentally squashed, the bottle becomes difficult to reinflate and has to be replaced. If you prefer to remove the label, use a marker and draw a bull's-eye on the side of the bottle. The launch rod can be aimed at different angles by tilting to one side or another. Rotating the entire launcher horizontally changes its direction.

When using the launcher, place it in an open space. It can be used inside a gymnasium or cafeteria. If using inside, aim the launch tube at a low angle towards a far wall. Select a target to aim for. If using outside (choose a calm day), the launcher should be aimed at a clear area. For fun, place a basketball in the landing zone. Tell students to imagine the ball is the planet Mars (it's the right color!) and have them launch their rocket to Mars.

Make sure the student doing the launching and any other students near the launcher are wearing eye protection. Do not permit any students to stand in front of the launcher or in the landing zone while "launch operations" are taking place.

## Procedure

1. Cut the PVC pipe into the following lengths:
  - 3 pieces 12 in. long
  - 3 pieces 6 in. long
2. Insert the end of one 12 in. pipe a few inches into the neck of the bottle and tape it securely with duct tape.
3. Follow the construction diagram below for assembly of the launcher.

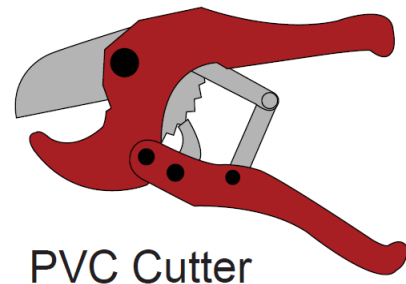

PVC Cutter

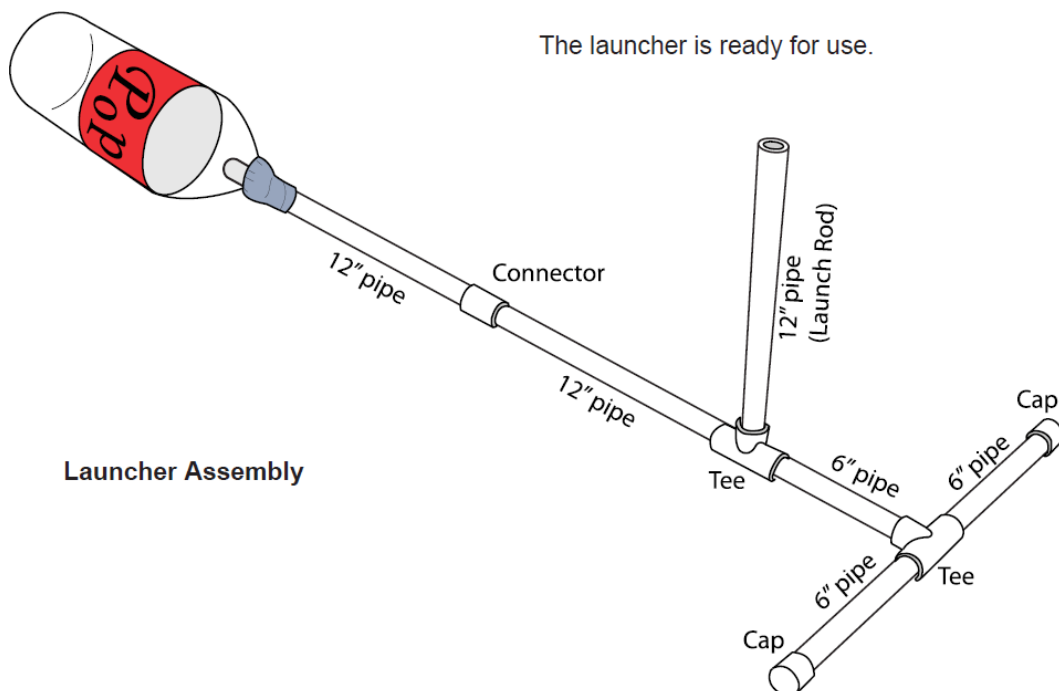

Launcher Assembly

The launcher is ready for use.

## Using the Pop! Rocket Launcher

1 Place the launcher in an open space and tilt the launch tube in the desired direction. If there is a light wind, aim in the direction of the wind. If shooting at targets, have each student aim the launcher for his or her flight.

2. Make sure the landing zone is clear of anyone who might be hit by the rocket.

3. Have the launching student put on eye protection and do a countdown to zero.





4. The student should stomp or jump on the label of the bottle. This will force most of the air inside the bottle through the tubes and launch the rocket.

5. While the student is retrieving the rocket, reinflate the 2-liter bottle. Separate the bottle from the launcher by pulling it from the connector. Wrap your hand around the pipe end to make a loose fist and blow through opening into the pipe. Doing so keeps your lips from touching the pipe. Reconnect the bottle to the launcher and it is ready to go again.

6. When the landing zone is clear, have the next student put on the goggles, slide the rocket on to the launcher, aim the launcher, do the countdown, and stomp on the bottle.

**Tip** If you permit students to reinflate the bottles themselves, demonstrate the reinflation process. Show them how to blow through their hands into the pipe. Stress that they should not place their lips on the pipe itself. They can practice actual inflation by squishing the bottle and reinflating it.

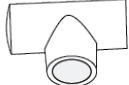
### Shopping List

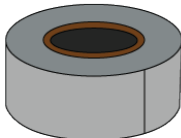
<p><b>1 - 1/2 in. Pipe (PVC)</b> 5 feet long (to be cut into smaller pieces). Hardware store or plumbing supply.</p> 	<p><b>1 - 1/2 in. Connector (PVC) Slip*</b> Hardware store or plumbing supply.</p> 	<p><b>2 - 1/2 in. Tees (PVC) Slip*</b> Hardware store or plumbing supply.</p> 
<p><b>2 - 1/2 in. Caps (PVC) Slip*</b> Hardware store or plumbing supply.</p> 	<p><b>Duct Tape</b> Hardware store</p> 	<p><b>TIP:</b> Be prepared for a damaged bottle by buying extra connectors and pipe. Join the connectors to 12 in. long pipes and attach 2 - liter bottles to the other ends. When a bottle becomes damaged, switching to a new bottle is fast and easy.</p>

\*Slip means a non-threaded joint.



# Rocket Activity

## Pop! Rockets

### Objectives

Students design, construct, and launch paper rockets.

### Description

A rocket with a triangular cross section is made from three rocket-shaped strips of card-stock paper and launched with the Pop! Rocket Launcher. Students can customize their rocket fin shapes and decorate the rockets using a computer with an illustration program. An alternative single-piece Pop! Rocket is also explained.

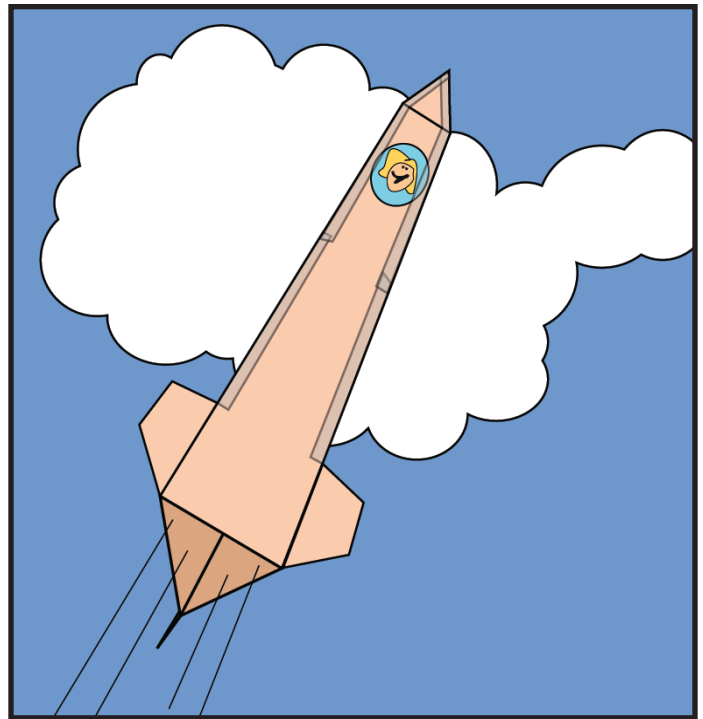

### Materials

- Card stock paper
- Glue stick
- Cellophane tape
- Scissors
- Optional - Computer with an illustration program and printer
- Crayons or colored markers
- Ruler
- Pop! Rocket Launcher (see page 64)
- Penny
- 30 cm-long pieces of 1/2 in. PVC pipes

### Management

Pop! Rockets are made by cutting out three rocket-shaped pieces of paper and joining them together. The basic pattern is a long rectangle with a triangle on one end. When the three rocket sides are taped together, the triangles are bent inward and taped to form a three-sided pyramid that serves as the rocket's nose cone. At the opposite end are geometric shapes such as triangles or parallelograms, that extend from the sides of the rectangles to form the fins. The fins are glued or taped together face-to-face to make them stiff.

### National Science Content Standards

Unifying Concepts and Processes

- Evidence, models, and explanation
- Change, constancy, and measurement

Science as Inquiry

- Abilities necessary to do scientific inquiry

Physical Science

- Position and motion of objects
- Motions and forces

Science and Technology

- Abilities of technological design

### National Mathematics Content Standards

- Number and Operations
- Geometry
- Measurement
- Data Analysis and Probability

### National Mathematics Process Standards

- Problem Solving
- Reasoning and Proof
- Communication
- Connections
- Representations

The basic pattern is found on page 71. If you have a computer with an illustration program available, the pattern can be laid out on the computer and the fins custom-designed by your students. The only dimension that must be preserved is the width of the rectangle. The three rectangles, when taped side-to-side, form a triangular prism shape that slides over the launch tube of the Pop! Rocket Launcher.

Print the blank rocket pattern or student's custom-designed rockets on card stock paper. If designing by computer, make three copies of the pattern on the page. To make all patterns fit, use the rotation control to rotate the middle pattern upside down.

If using the rocket with young students, enlist the aid of older students for the rocket assembly (peer teaching) or have the patterns cut out and fold lines scored in advance. Before taping, have students draw pictures of themselves or friends or family peering out from "port holes" near the nose cone end of the rockets. The rockets can be decorated along their entire length. If using a computer illustration program, the decoration can be added to the pattern before printing.

Have students tape a penny to the inside of one of the three nose cone triangles before taping the nose cone together. The penny adds additional mass to the nose and increases its flight stability.

To provide support for the nose cone during taping, insert a PVC pipe segment into the rocket.

Ask students why fins are important to the rocket shape. After collecting their ideas, demonstrate how fins work by tossing two rockets (without the pennies) like javelins into the air. One should have fins and the other should not. The rocket with fins will sail straight across the room, while the one without will flop or tumble in the air. Have your students describe and explain what happened.

## Procedure

### Three-Piece Pop! Rocket

1. If using a computer with an illustration program for designing Pop! Rockets, draw a vertical rectangle that is 3 cm wide and 22 cm long. The nose cone triangle can either be an isosceles or equilateral triangle. Add fins to the sides of the bottom of the rectangle. Keep in mind that the size of the paper limits the size of the fins.
2. After completing one rocket pattern, copy it two times and fit all the pieces on the paper with two patterns pointing up and one pointing down. If the fins are too large for a single sheet of paper, create two patterns on one page and the third on a second page.
3. When the patterns are complete, students can add decorations to their rockets or wait until the patterns are printed and then decorate them.
4. Cut out the three pieces and press the edge of a ruler to the fold lines for the fins and nose cone to get a straight fold. Fold the fins outward.

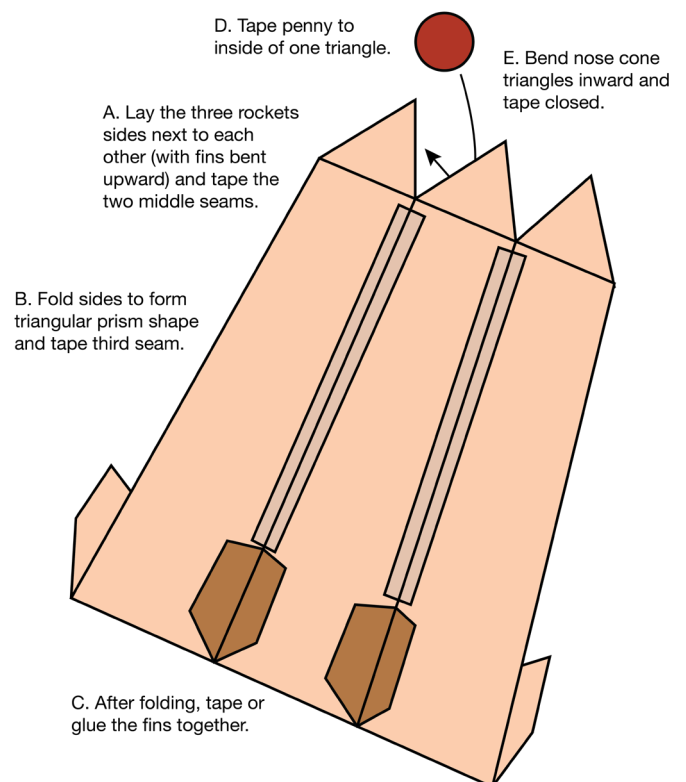

5. Tape a penny securely to the inside of one of the nose cone triangles.

6. Slide the pieces together and match up the sides of the rocket body. Run a strip of tape along the seams. Do not tape the fins or nose cone pieces yet.

7. Pick up the rocket, bring the two side pieces together, and tape the seam. It may be helpful to insert the PVC pipe into the rocket before taping.

8. Use glue stick or tape to join adjacent fins pieces together to make three fins. If desired, the fins can be left untaped to make six fins.

9. Push the PVC pipe inside the rocket body up to the position of the nose cone. Use the pipe for support while taping. Fold the three triangles inward and tape the seams.

10. The rocket is ready for launch! Follow the launch instructions for the Pop! Rocket Launcher (page 65).

#### Ideas for Different Fin Shapes

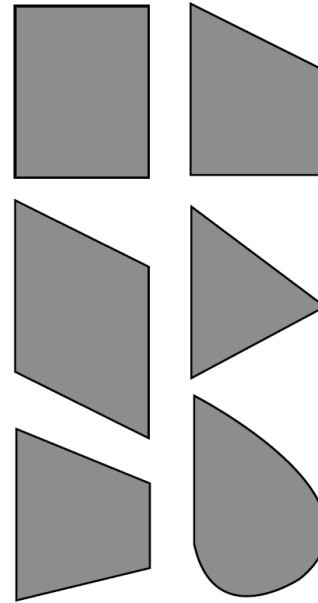

## Procedure

### One-Piece Pop! Rocket

1. Print the pattern on the next page on card stock paper.
2. Use a ruler and the edge of a penny to score the fold lines. To do so, place the ruler along a dashed line and run the edge of the penny (held at an angle) across the paper to make a small groove. The groove will insure that the fold line is both accurate and straight.
3. Cut out the pattern on the solid lines.
4. Tape a penny to the inside of one of the nose cone triangles.
5. Fold the three rectangles into a triangular prism shape with the large tab inside. Tape the seam.
6. Fold the triangles inward to form the nosecone. The tabs should be inside. They will provide support for taping.
7. Bend the fins outward. The rocket is ready for flight.

**Completed Three-Piece Pop! Rocket**

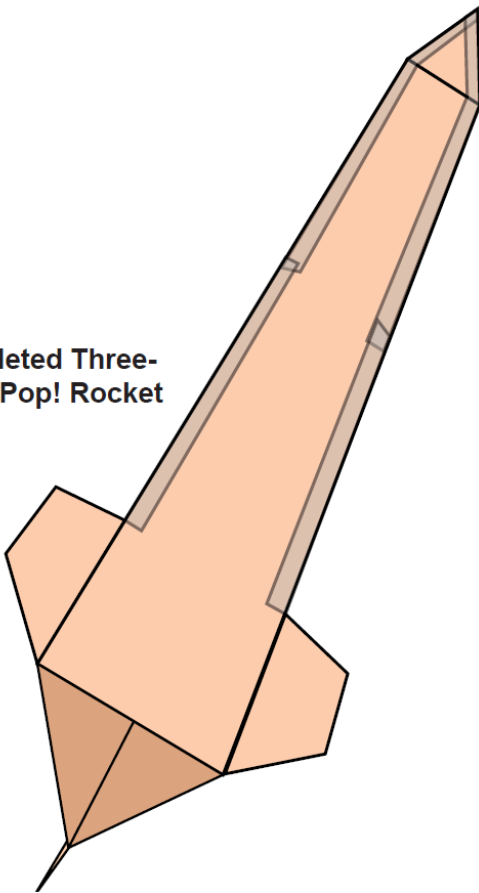

## Discussion

### What are the parts of a rocket?

The pointy upper end of the rocket is the nose cone. It helps the rocket spread apart the air as the rocket flies. The nose cone can be compared to the pointed bow of a boat that spreads water apart as it sails forward. Astronauts and spacecraft are usually placed in or near the nose cone. (Note: The space shuttle is a little different in design. However, the astronauts still ride in the cone-shaped front of the Orbiter.)

The body of the rocket is the tube-shaped (triangular-shaped in this activity) part of the rocket that holds the rocket fuel.

Engines are where the rocket fuel is burned. These are found at the lower end of the rocket body. The engines push the rocket into space.

Fins are the tiny wings at the lower end of the rocket body. They help the rocket fly straight.

## Assessment

- Ask students to write or tell a short story describing their rocket and how they flew.
- Have students draw pictures of their rockets flying through space.

## Extensions

- Compare rockets to an arrow, a weather vane, or a dart. Bring one or more of these objects to class and compare them to the shape of the students' rockets.
- Show pictures of different rockets and compare them to students' rockets.

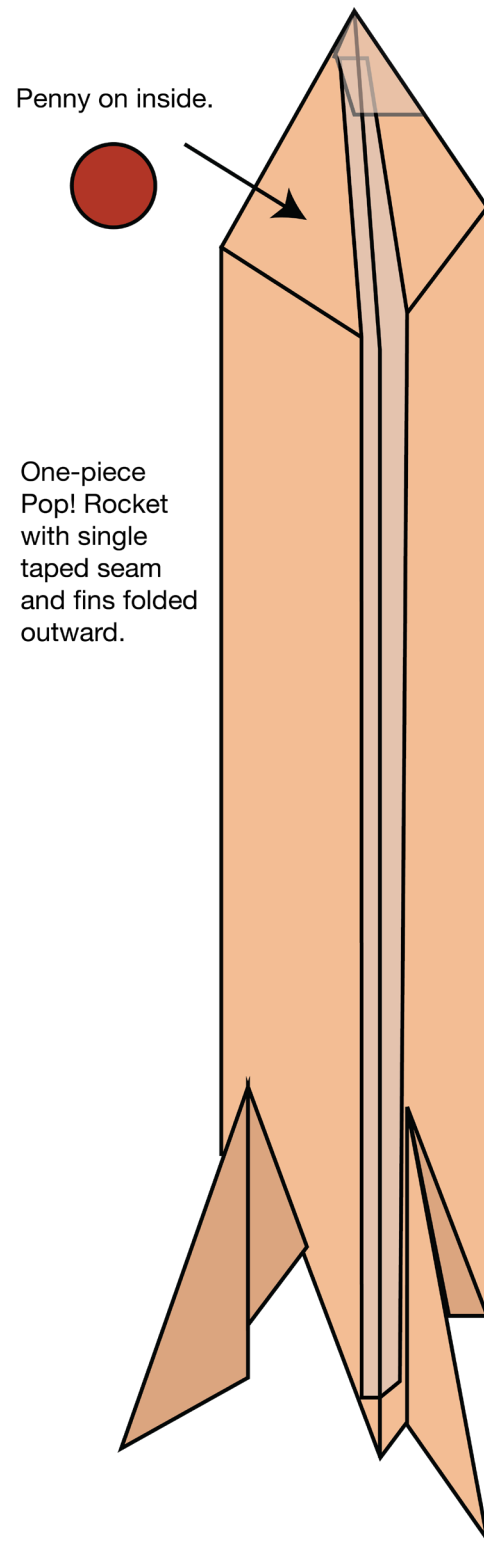

**Three-Piece  
Pop! Rocket**

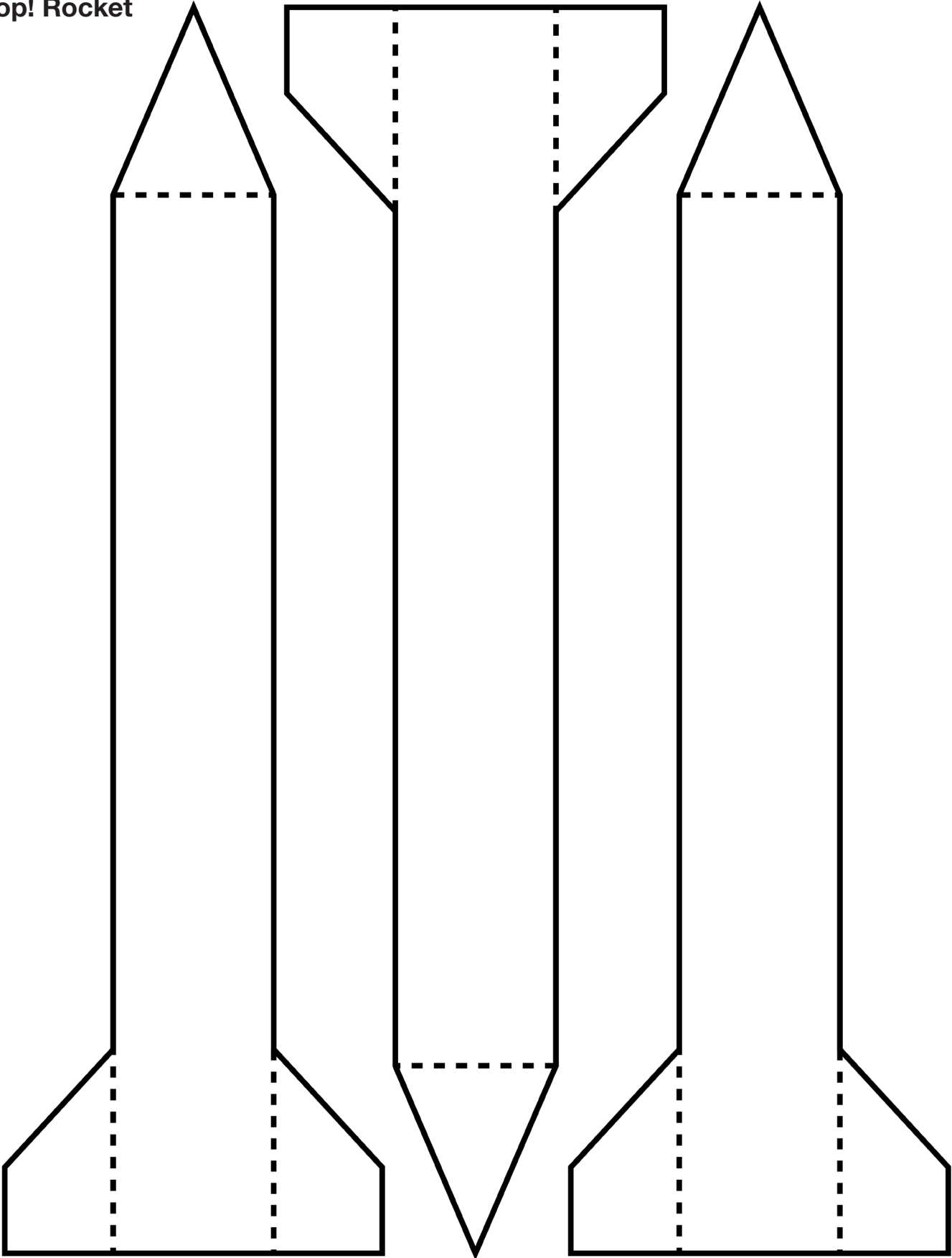

**One-Piece  
Pop! Rocket**

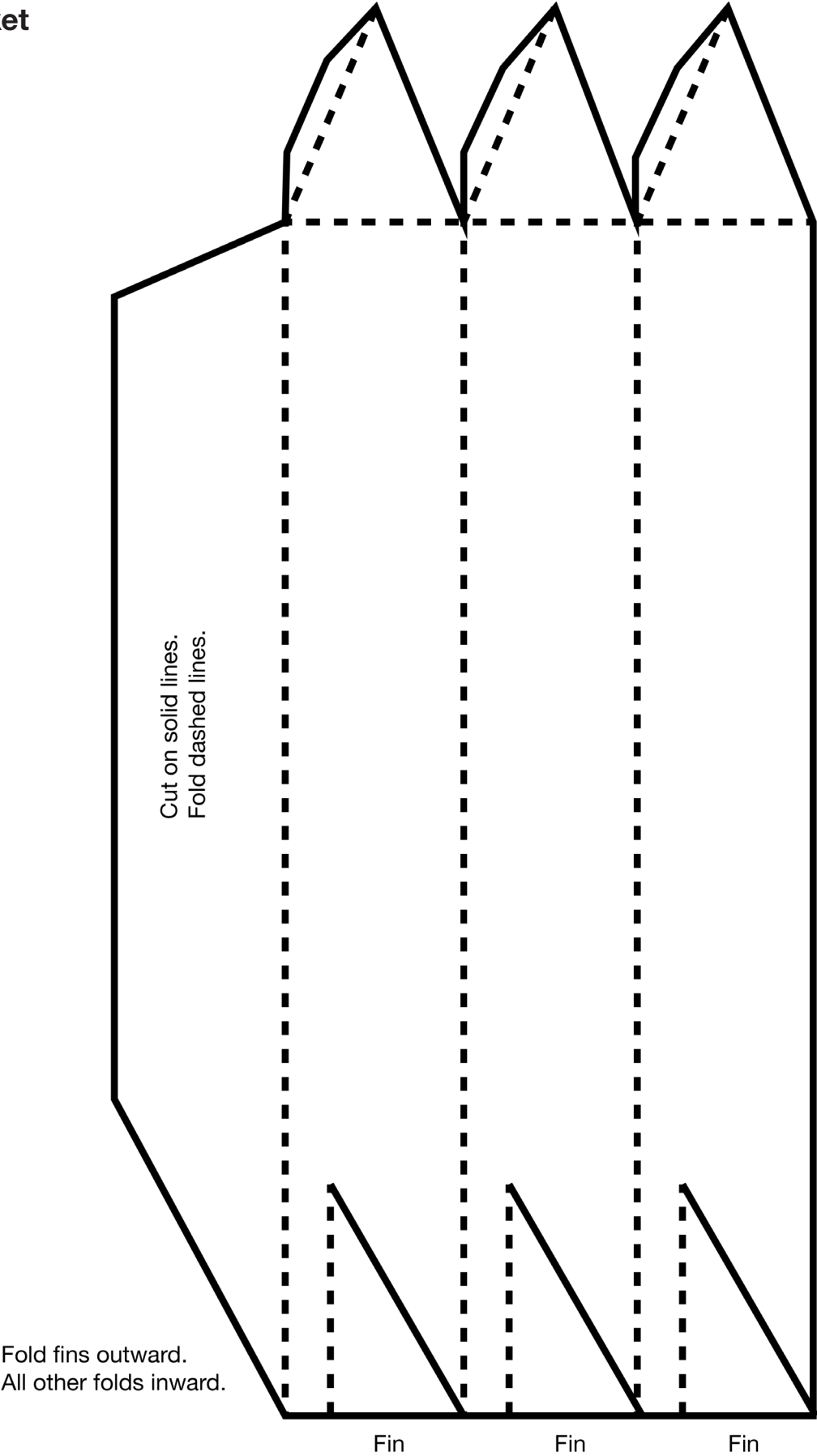

# Rocket Activity

## Foam Rocket

### Objectives

Students will learn about rocket stability and trajectory with rubber band-powered foam rockets.

### Description

Students will construct rockets made from pipe insulating foam and use them to investigate the trajectory relationship between launch angle and range in a controlled investigation.

### Materials

- 30 cm-long piece of polyethylene foam pipe insulation (for 1/2 in. size pipe )
- Rubber band (size 64)
- Styrofoam food tray, cardboard, or stiff posterboard
- Duct tape
- Scissors
- Meter stick
- Press tack
- Washer or nut
- Quadrant plans printed on card stock Rocket construction instructions Experiment data sheet
- Masking tape
- Launch record sheet
- Eye protection
- For class - tape measure

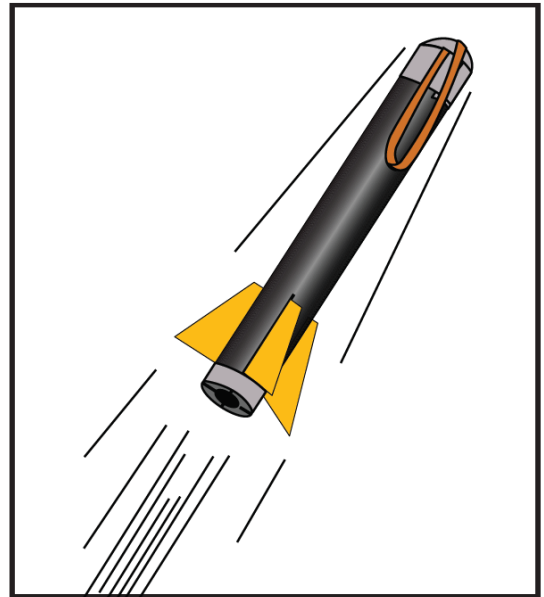

### National Science Content Standards

Unifying Concepts and Processes

- Evidence, models, and explanation
- Change, constancy, and measurement

Science as Inquiry

- Abilities necessary to do scientific inquiry

Physical Science

- Position and motion of objects
- Motions and forces

Science and Technology

- Abilities of technological design

### National Mathematics Content Standards

- Number and Operations
- Algebra
- Geometry
- Measurement
- Data Analysis and Probability

### National Mathematics Process Standards

- Reasoning and Proof
- Communication
- Connections
- Representations

## Management

Select a large room with a high ceiling for the launch range, such as a cafeteria or gymnasium. Place markers on the floor at 1 m intervals starting at 5 m and going to 20 m. If it is a calm day, the investigation can be conducted outside. Although the rockets can be launched outside on windy days, the wind becomes an uncontrolled variable that may invalidate the results. Prepare some sample rocket fins to show how they are constructed. Refer to the construction page for details.

Before conducting the investigation, review the concept of control. In this investigation, control will be how much the rubber band is stretched when launching the rockets. The experimental variable will be the angle of launch. Students will compare the launch angle with the distance the rocket travels. Organize students into teams of three. One student is the launcher. The second student confirms the launch angle and gives the launch command. The third student measures the launch distance, records it, and returns the rocket to the launch site for the next flight. The experiment is repeated twice more with students switching roles. The distances flown will be averaged. Teams will try different angles and determine what the best launch angle should be to obtain the greatest distance from the launch site.

## Background

The foam rocket flies ballistically. It receives its entire thrust from the force produced by the elastic rubber band. The rubber band is stretched. When the rocket is released, the rubber band quickly returns to its original length, launching the foam rocket in the process. Technically, the foam rocket is a rocket in appearance only. The thrust of real rockets typically continues for several seconds or minutes, causing continuous acceleration, until propellants are exhausted. The foam rocket gets a quick pull and then coasts. Furthermore, the mass of the foam rocket doesn't change in flight. Real rockets consume propellants and their total mass diminishes.

**Tip** Be sure the range-measuring student measures where the rocket touches down and not where the rocket ends up after sliding or bouncing along the floor.

Nevertheless, the flight of a foam rocket is similar to that of real rockets. Its motion and course is affected by gravity and by drag or friction with the atmosphere. The ability to fly foam rockets repeatedly (without refueling) makes them ideal for classroom investigations on rocket motion.

The launch of a foam rocket is a good demonstration of Newton's third law of motion. The contraction of the rubber band produces an action force that propels the rocket forward while exerting an opposite and equal force on the launcher. In this activity, the launcher is a meter stick held by the student.

In flight, foam rockets are stabilized by their fins. The fins, like feathers on an arrow, keep the rocket pointed in the desired direction. If launched straight up, the foam rocket will climb until its momentum is overcome by gravity and air drag. At the very top of the flight the rocket momentarily becomes unstable. It flops over as the fins catch air. The rocket becomes stable again when it falls back to the ground.

When the foam rocket is launched at an angle of less than 90 degrees, its path is an arc whose shape is determined by the launch angle. For high launch angles, the arc is steep, and for low angles, it is broad. When launching a ballistic rocket straight up (neglecting air currents) the rocket will fall straight back to its launch site when its upward motion stops. If the rocket is launched at an angle of less than 90 degrees, it will land at some distance from the launch site. How far away from the launch site is dependent on four things. These are:

- gravity
- launch angle
- initial velocity
- atmospheric drag



Gravity causes the foam rocket to decelerate as it climbs upward and then causes it to accelerate as it falls back to the ground. The launch angle works with gravity to shape the flight path. Initial velocity and drag affects the flight time.

In the investigation, students will compare the launch angle to the range or distance the foam rocket lands from the launch site. Launch angle is the independent variable. Gravity can be ignored because the acceleration of gravity will remain the same for all flight tests. Atmospheric drag can also be ignored because the same rocket will be flown repeatedly. Although students will not know the initial velocity, they will control for it by stretching the rubber band the same amount for each flight. The dependent variable in the experiment is the distance the rocket travels.

Assuming student teams are careful in their control of launch angles and in the stretching of the launch band, they will observe that their farthest flights will come from launches with an angle of 45 degrees. They will also observe that launches of 30 degrees, for example, will produce the same range as launches of 60 degrees. Twenty degrees will produce the same result as 70 degrees, etc. (Note: Range distances will not be exact because of slight differences in launching even when teams are very careful to be consistent. However, repeated launches can be averaged so that the ranges more closely agree with the illustration.

## Procedures

### Constructing a Foam Rocket

1. Using scissors, cut one 30 cm length of pipe foam for each team.
2. Cut four equally spaced slits at one end of the tube. The slits should be about 12 cm long. The fins will be mounted through these slits.
3. Cut a 12 cm length of duct tape down the middle to make two pieces. Place one piece over the other, sticky to shiny side, to make the tape double-strong.

4. Slip a rubber band over the tape and press the tape around the nose end of the rocket (opposite the end with the slits). Press the tape tightly and reinforce it with another length of tape wrapped around the tube.

5. Cut fin pairs from the foam food tray or stiff cardboard. Refer to the fin diagram. Both fin pairs should be notched so that they can be slid together as shown in the diagram. Different fin shapes can be used, but they should still “nest” together.

7. Slide the nested fins into the slits cut in the rear end of the rocket. Close off the slits with a piece of duct tape wrapped around the foam tube. The rocket is finished.

## Procedure

### Making the Launcher

1. Print the quadrant pattern (page 79) on card stock paper.
2. Cut out the pattern and fold it on the dashed line.
3. Tape the quadrant to the meter stick so that the black dot lies directly over the 60 cm mark on the stick.
4. Press a push tack into the black dot.
5. Tie a string to the push tack and hang a small weight, such as a nut or a washer, on the string. The weight should swing freely.
6. Refer to the diagram to see how the launcher is used.

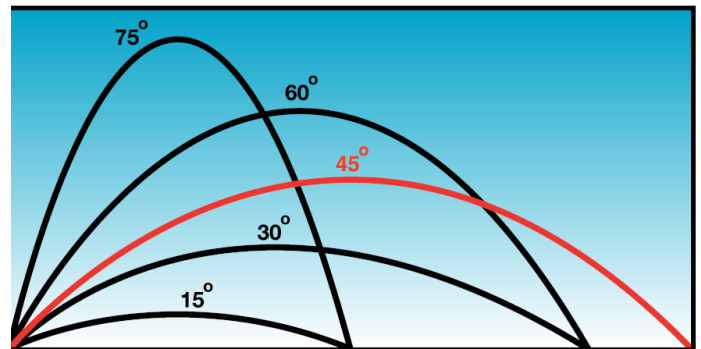

Launch angle vs. range for rockets with the same initial launch velocity.

## Discussion

- *Why didn't the experiment protocol call for launching at 0 and 90 degrees?*

Assuming a perfect launch, a rocket launched straight upwards should return to the launch pad. Any variation in the impact site will be due to air currents and not to the launch angle. A rocket launched horizontally will travel only as long as the time it takes to drop to the floor.

- *Shouldn't the rocket be launched from the floor for the experiment?*

Yes. However, it is awkward to do so. Furthermore, student teams will be measuring the total distance the rocket travels, and consistently launching from above the floor will not significantly affect the outcome.

## Assessment

- Have student teams submit their completed data sheets with conclusions.
- Have students write about potential practical uses for the foam rocket (e.g., delivering messages).

## Using the Launcher

Loop the rubber band over the launcher end. Pull on the fin end of the rocket until the nose cone is aligned with the 30 cm mark. Tilt the launcher up at the chosen angle as indicated with the string and weight on the quadrant. Launch the rocket!

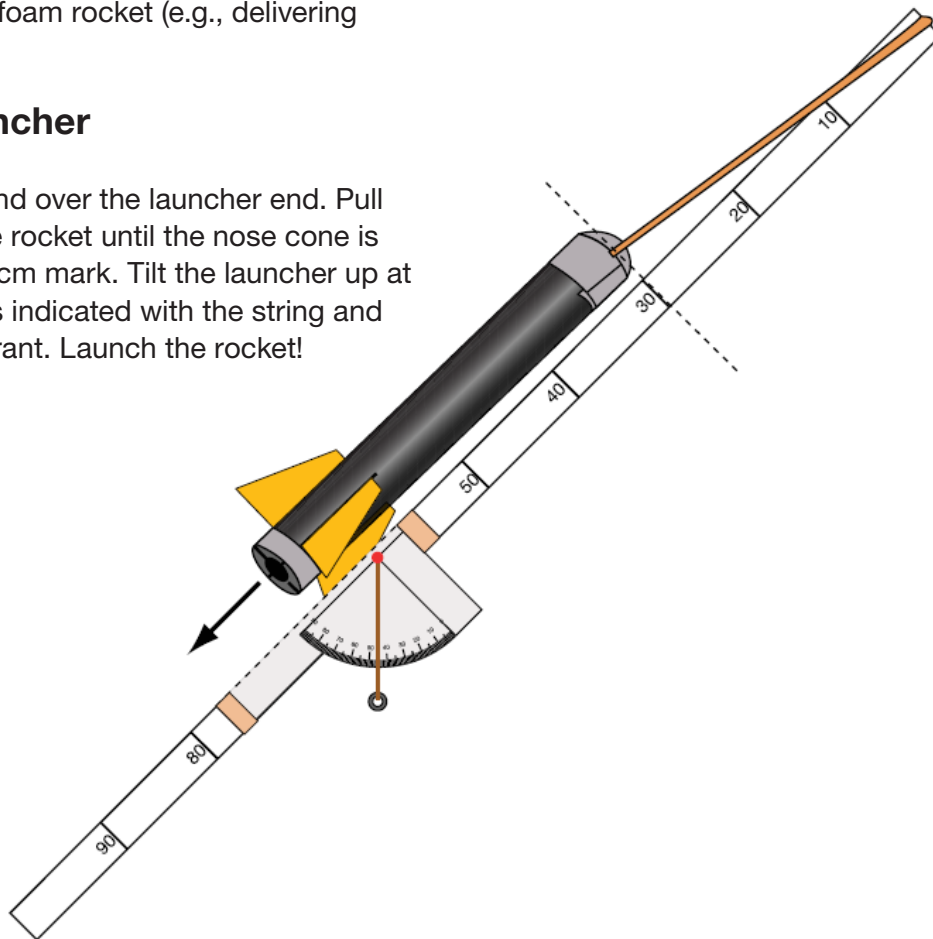

Cut slots the same width as the thickness of the fin stock.

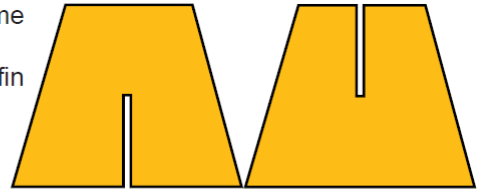

Nest fins together.

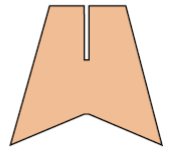
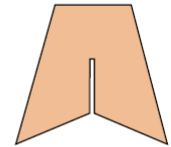

Different fin shapes can be used.

## Extensions

For advanced students, the following equation can be used for estimating range assuming level ground and no air resistance.

$$\text{Range} = \frac{V_o^2}{g} \sin 2A$$

**$V_o$  = Initial Velocity**

**$g = 9.8 \text{ m/second}^2$**

**$A$  = Launch Angle**

( $g$  is the acceleration of gravity on Earth)

Students will have to determine initial velocity. If available, an electronic photogate (science lab probeware) with timer can be used for determining the initial velocity. Otherwise, challenge students to devise a method for estimating initial velocity. One approach might be to launch the rocket horizontally from a tabletop and measure the horizontal distance the rocket travels as it falls to the floor. Using a stopwatch, measure the time the rocket takes to reach the floor. If the rocket takes 0.25 seconds to reach the floor and traveled 3 m horizontally while doing so, multiply 3 m by 4. The initial velocity will be 12 m per second. Students should repeat the measurement several times and average the data to improve their accuracy. (This method assumes no slowing of the rocket in flight due to air drag.)

- Different kinds of fins can be constructed for the foam rocket. Try creating a space shuttle orbiter or a future rocket plane for exploring the atmosphere of other planets.

# Build a Foam Rocket

1. Cut four slits 12 cm long 90 degrees apart.

1.

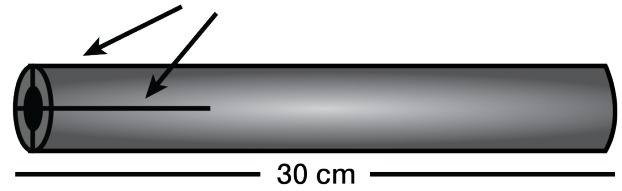

2. Cut 12 cm strip of duct tape in half lengthwise. Place one strip on top of other.

2.

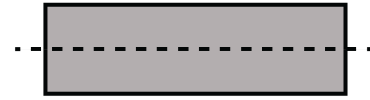

3. Tape launcher rubber band to nose end of rocket.



4. Add tape strip around the nose to strengthen the attachment.

3.

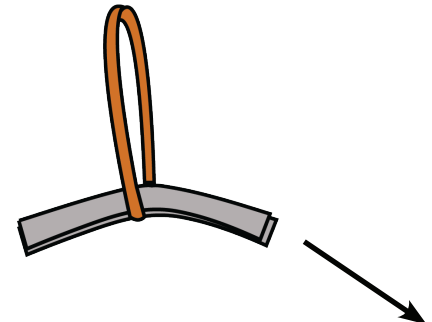

5. Cut out fins with notches.

4.

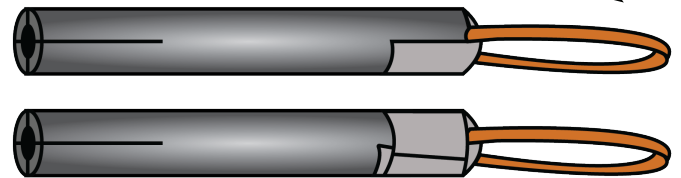

6. Slide fins together.

7. Slide fins into slits.

8. Close fin slits with narrow strip of duct tape.

5.



6.

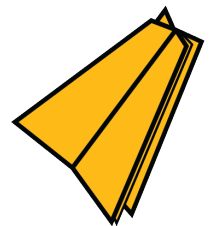

Ready for flight!

7.



8.

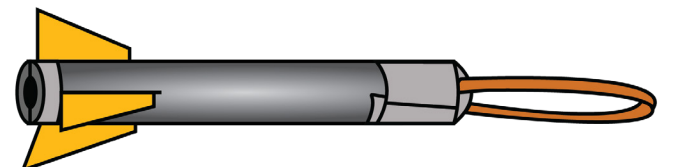

# Launch Quadrant Pattern

(Actual Size)

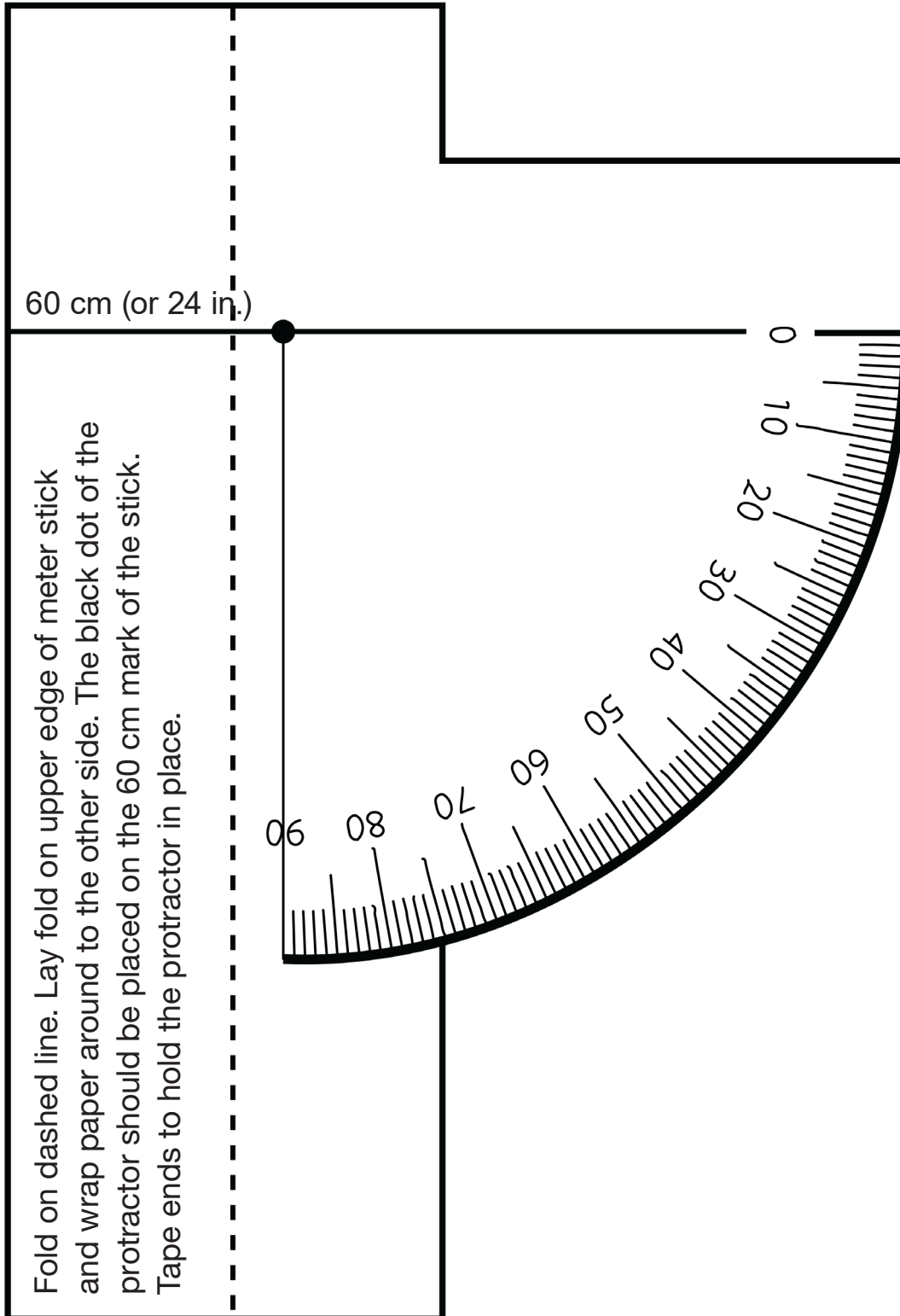

# Rocket Range Experiment

Team Member Names: \_\_\_\_\_

1. Assign duties for your team. You will need the following positions:  
Launch Director, Launcher, and Range Officer. (Team members will switch jobs later.)

2. First Launch:

**Launcher** - Attach the rocket to the launcher and pull back on string until its tail reaches the 60 cm mark. Tilt the launcher until it is pointing upwards at an angle of between 10 and 80 degrees. Release the rocket when the launch command is given.

**Launch Director** - Record the angle on the data table. Give the launch command. Record the distance the rocket travels.

**Range Officer** - Measure the distance from the launcher to where the rocket hits the floor (not where it slides or bounces to). Report the distance to the launch director and return the rocket to the launcher for the next launch.

3. Repeat the launch procedures four more times but with a different angle (between 10 and 80 degrees) each time.

4. Run the entire experiment twice more but switch jobs each time. Use the same launch angles used for the first set of launches.

5. Compare your data for the three experiments.

Data Table 1

Launch Angle	Distance

Data Table 2

Launch Angle	Distance

Data Table 3

Launch Angle	Distance

From your data, what launch angle should you use to achieve the greatest distance from the launch site? Test your conclusion.

Why didn't the instructions ask you to test for 0 and 90 degrees?

# Rocket Activity

## Launch Altitude Tracker

### Objectives

Using a simple altitude tracker and basic mathematics, students will indirectly measure the altitude achieved by the rockets they construct.

### Description

Determining the altitude reached by a rocket is a relatively simple process using a hand held tracking device. The device is a sighting tube with a marked water level that permits measurement of the inclination of the tube. Using simple mathematics, students will calculate the altitude of the rocket. With two trackers in different locations, accuracy of the estimates can be improved.

### Materials

- Tracker (see separate instructions)
- Tape measure
- Tangent table
- Data sheet
- Calculator (optional)

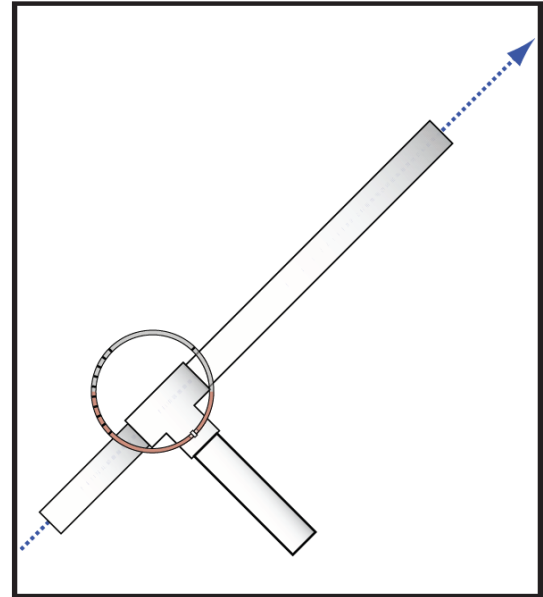

### National Science Content Standards

#### Physical Science

- Position and motion of objects
- Motions and forces

#### Science and Technology

- Understanding about science and technology

### National Mathematics Content Standards

- Number and Operations
- Geometry
- Measurement
- Data Analysis and Probability

### National Mathematics Process Standards

- Problem Solving
- Reasoning and Proof
- Communication
- Connections
- Representations

### Management

Altitude trackers are easy to construct. They are rugged and can be used again and again. Use them for altitude measurements with the High-Power Air Rockets and the Project X-51 activities. These rockets are capable of flights between 50 and 100 m high. Be sure students understand how to sight rockets with the tracker. If you have a flagpole or tall building near the launch site, have students practice taking measurements of the angle between the ground and the top of the pole or to one of the upper corners of the building.

When students are comfortable using the tracker and are consistent in measuring, they are ready to track rockets. Lay out a baseline from the launch site. Details for doing this are given in the procedure. A longer baseline provides better measurements than a shorter one. However, long baselines mean that your students will be spread out on the launch range. You may wish to enlist a teacher aide to help with supervision.

## Background

Altitude tracking of small rockets is an exciting activity for students because it provides them with a way of estimating how high their rocket flies. The technique for doing this is relatively simple. The rocket is launched and a tracker, some distance away, sights the rocket and determines the angle between the ground and the rocket at the top of its flight. Using a simple formula, the altitude is calculated.

$$a \text{ (altitude)} = \text{tangent of } A \text{ (angle)} \times b \text{ (baseline)}$$

$$a = \tan A (b)$$

To solve the formula, students look for the angle they measured on the tangent table. For example, the angle is 30 degrees. The tangent is 0.5774. They use that number in the equation. The baseline (distance from the launch pad to the tracker) is measured with a tape measure. In our example the distance is 25 m.

$$a = 0.5774 \times 25 \text{ m} = 14.435 \text{ m}$$

The altitude reached by the rocket is 14.435 m.

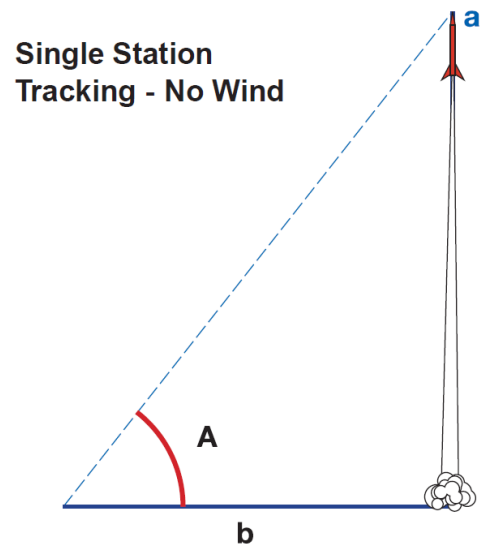

$$a = \tan A (b)$$

Angle	Tangent	Angle	Tangent
0	.0000	46	1.036
1	.0175	47	1.072
2	.0349	48	1.111
3	.0524	49	1.150
4	.0699	50	1.192
5	.0875	51	1.235
6	.1051	52	1.280
7	.1228	53	1.327
8	.1405	54	1.376
9	.1584	55	1.428
10	.1763	56	1.483
11	.1944	57	1.540
12	.2126	58	1.600
13	.2309	59	1.664
14	.2493	60	1.732
15	.2679	61	1.804
16	.2867	62	1.881
17	.3057	63	1.963
18	.3249	64	2.050
19	.3443	65	2.145
20	.3640	66	2.246
21	.3839	67	2.356
22	.4040	68	2.475
23	.4245	69	2.605
24	.4452	70	2.747
25	.4663	71	2.904
26	.4877	72	3.078
27	.5095	73	3.271
28	.5317	74	3.487
29	.5543	75	3.732
30	.5774	76	4.011
31	.6009	77	4.331
32	.6249	78	4.705
33	.6494	79	5.145
34	.6745	80	5.671
35	.7002	81	6.314
36	.7265	82	7.115
37	.7536	83	8.144
38	.7813	84	9.514
39	.8098	85	11.43
40	.8391	86	14.30
41	.8693	87	19.08
42	.9004	88	28.64
43	.9325	89	57.29
44	.9657	90	—
45	1.000	—	—



## Procedure

### Making the Tracker

1. Fill one half of the aquarium hose with colored water and join the ends with the connector to form a ring.
2. Center the ring on the Marking Diagram and mark the hose starting at 0 degrees and going up to 90. Use a straight line for 10 degree intervals and dots for 5 degrees. Also mark the other 0 degree mark on the opposite side of the ring. It doesn't matter where the water is resting when you mark the ring. When the ring is mounted on the tracker, the water will settle horizontally.
3. Join the PVC pieces together as shown in the diagram.
4. Using clear tape, tape the ring vertically to the side of the PVC tee. The two 0 degree marks should line up with the sighting tube. The tracker is ready to be used.

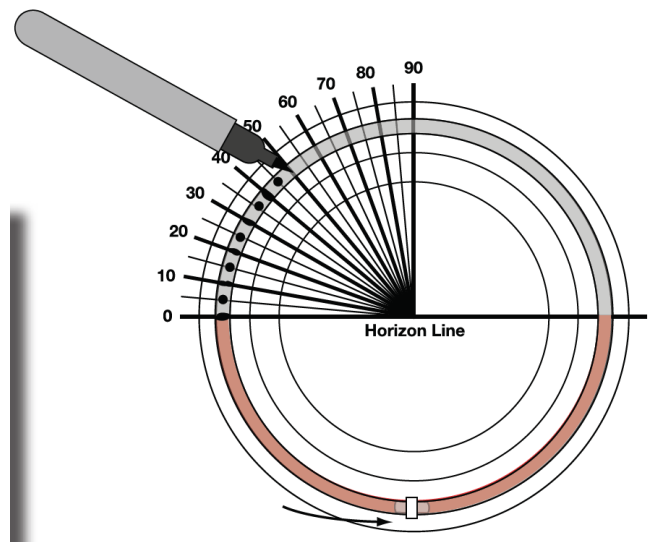
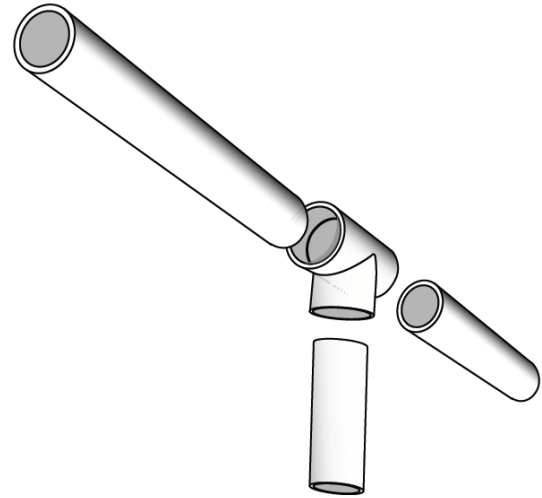

### Materials

- 1/2 in. PVC pipe (2 6 in. long pieces, 1 12 in. long piece)
- 1/2 in. PVC tee connector
- 1 10 in. length of aquarium airline hose (clear vinyl)\*
- 1 straight airline connector\*
- Water and food coloring
- Permanent marker
- Marking Diagram
- \* Available at aquarium stores

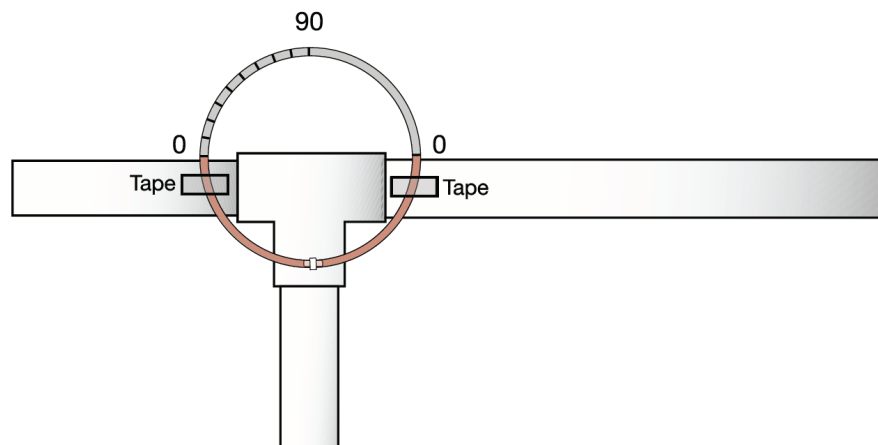

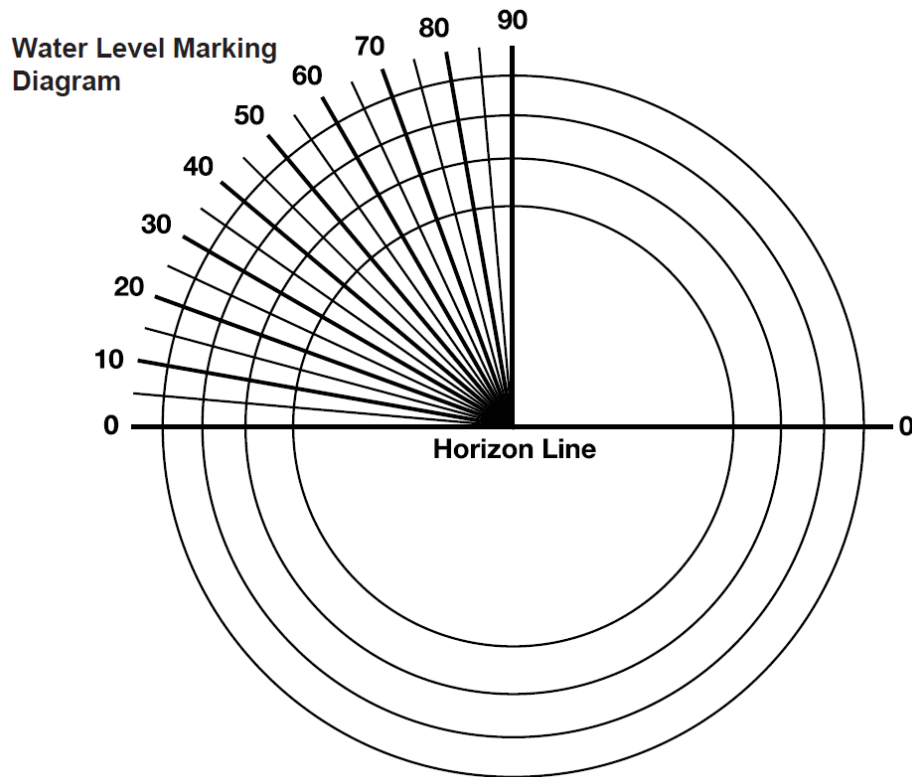

## Procedure

### Using the Tracker

1. Select an open space for the launch. If the wind is strong, position the launch pad up wind so that the wind will blow the rocket on the field when it falls back.
2. Measure out the longest baseline you can conveniently have for the size of the launch field available. Align the baseline with the wind. (See note for using two tracking stations.)
3. Make sure the students at each station know which rocket is about to launch. When the rocket is launched, the tracking students aim their trackers at the highest point in the flight of the rocket. The angles of the trackers are read from the water level and the data recorded. Have the students help each other in reading the angle from the water level. For greater accuracy, have students average their estimates. Calculations can be done back in the classroom.

## Notes

Assuming perfect conditions, the rocket goes straight up from the launch pad. This creates a right angle with Earth and the computed altitude should be accurate. However, altitude estimates for rockets that stray from the vertical will be less accurate. To minimize wind effects, two tracking stations can be used. Each are placed at equal distances from the launcher. The line connecting the two sites should be parallel to the wind. The students at each site track the rocket. Assuming the wind causes the rocket to drift over the up wind station, that tracker will get a higher angle than if the rocket had climbed straight up. The student at the down wind station will get a lower angle. Their estimates are averaged together to correct for wind effects. The diagram on the next page shows how the two tracking stations coordinate to improve altitude estimates.

As students compare estimates, errors will be detected. Their altitude estimates are only as accurate as the measurements of the angles. Precise angle measurements are difficult, especially when the rocket is small and the altitude is great. A disagreement of 10 percent in the estimated altitude between trackers is acceptable.

## Discussion

- *Why will a rocket angle into the wind during launch?*

A crosswind will exert a force on the side of the rocket. Because of the fins, the lower end of the rocket has a greater surface area than the upper end. Like a weather vane, the rocket tends to nose into the wind and veer up wind.

- *Does the height of the person using the tracker have any effect on the measurement?*

Yes. For the greatest accuracy in measuring, add the tracking student's eye height to the estimate of the rocket's altitude.

- *If the rocket drifts away from the baseline before it reaches its maximum altitude does this affect the measurement?*

Yes. Two station tracking methods are available to correct for drift. In addition to the altitude angle measurement made at each station, the compass direction of the rocket's position also has to be measured. This greatly complicates the tracking procedure. Information about the process can be found on page 121.

## Assessment

- Review student participation in the activity and the completeness and accuracy of their altitude estimates.

## Extensions

- If there are any local chapters of rocketry clubs, invite a member in to demonstrate how model rocket and high-performance model rocket altitude is measured. (Many model rocketeers insert small electronic altimeters inside their rockets for direct altitude measurements.)

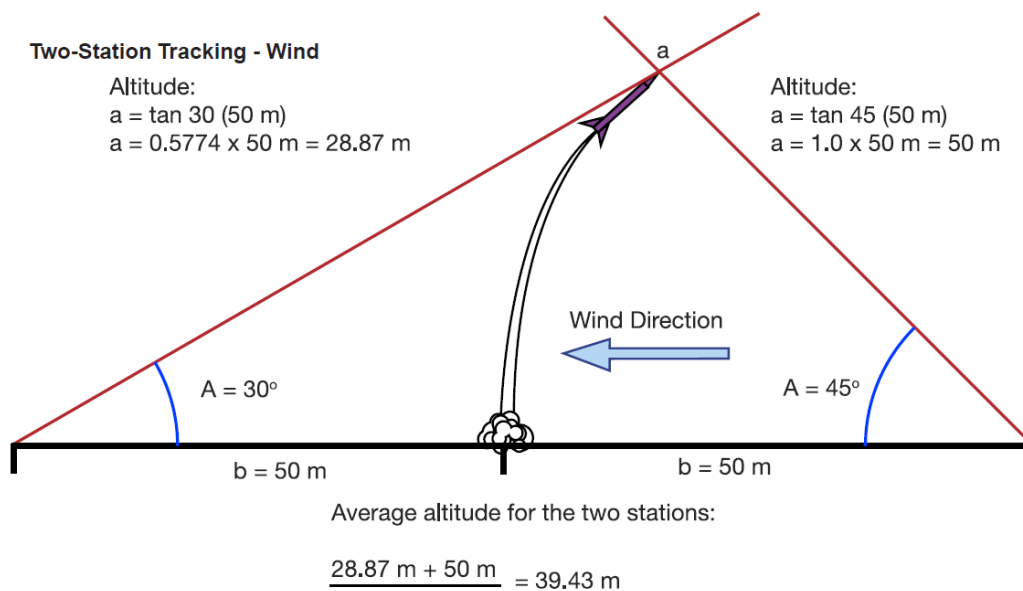

# Altitude Tracking Data Sheet

Tracker Name: \_\_\_\_\_

Baseline Length: \_\_\_\_\_

1. Measure the angle to the highest point the rocket reaches.
2. Record the angle.
3. Look up the tangent for the angle. Record that number.
4. Multiply the tangent number times the length of the baseline. The answer is the altitude the rocket reached.

Rocket	Angle	Tangent	Altitude

Calculations:

Angle Tangent		Angle Tangent	
0	.0000	46	1.036
1	.0175	47	1.072
2	.0349	48	1.111
3	.0524	49	1.150
4	.0699	50	1.192
5	.0875	51	1.235
6	.1051	52	1.280
7	.1228	53	1.327
8	.1405	54	1.376
9	.1584	55	1.428
10	.1763	56	1.483
11	.1944	57	1.540
12	.2126	58	1.600
13	.2309	59	1.664
14	.2493	60	1.732
15	.2679	61	1.804
16	.2867	62	1.881
17	.3057	63	1.963
18	.3249	64	2.050
19	.3443	65	2.145
20	.3640	66	2.246
21	.3839	67	2.356
22	.4040	68	2.475
23	.4245	69	2.605
24	.4452	70	2.747
25	.4663	71	2.904
26	.4877	72	3.078
27	.5095	73	3.271
28	.5317	74	3.487
29	.5543	75	3.732
30	.5774	76	4.011
31	.6009	77	4.331
32	.6249	78	4.705
33	.6494	79	5.145
34	.6745	80	5.671
35	.7002	81	6.314
36	.7265	82	7.115
37	.7536	83	8.144
38	.7813	84	9.514
39	.8098	85	11.43
40	.8391	86	14.30
41	.8693	87	19.08
42	.9004	88	28.64
43	.9325	89	57.29
44	.9657	90	---
45	1.000	---	---

# Rocket Activity

## Water Rocket Launcher

### Objectives

Construct a launch platform for launching water rockets.

### Description

Water rockets, built from plastic soft drink bottles, are capable of flights greater than 100 m. The bottles are partially filled with water and pressurized with compressed air delivered by a hand bicycle pump or small compressor. A special launch pad is required for holding the rocket while it is being pressurized. When the desired pressure is reached, the rocket is launched by releasing hold-down clamps. The instructions that follow explain how to construct the launcher and provides a list of needed materials. Only a few tools and simple construction techniques are required to construct a launch pad that can be used year after year.

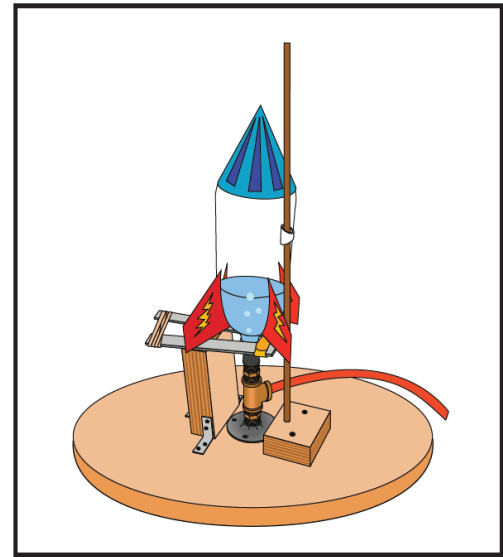

### National Science Content Standards

#### Physical Science

- Position and motion of objects
- Motions and forces

#### Science and Technology

- Abilities of technological design

### National Mathematics Content Standards

- Measurement

### National Mathematics Process Standards

- Connections

### Management

Most of the materials on the shopping list are obtained from a hardware/lumber store. If needed, the list can be given to a salesperson to assist in locating the needed parts. The list includes sizes, descriptions, and the number of each part required.

A scrap piece of 2 x 4 may be available at the lumber store. You will need two short pieces, 6 in. and 3 in. long. The short piece should have pilot holes drilled for the screws that will attach the block to the launcher base. The block supports a launch rod that guides the rocket during the first few moments of the liftoff. The other block should have pilot holes for attaching the corner irons to mount the block to the base and for supporting the hold-down clamps.

### Materials

- Refer to the shopping list (see page 91)
- Saw
- Drill
- Screw driver
- Bicycle pump or small electric compressor

Although not required, it is recommended that the wooden parts are painted or varnished. These parts will be blasted with water each time a rocket is launched, and finishing the wood will reduce potential warping.

## Assembly Instructions

1. Screw the galvanized floor flange (part #7) to the center of the launcher base.
2. Slide one end of the air hose (part #13) into the center hole of the pipe tee (part #9). The hose should be bent so that it extends about 7 cm out the top hole of the tee. It will take a little force to make the bend.
3. Thread the brass nipples (part #8) into each end of the tee. The hose will extend through the top nipple.
4. Jam the barb splicer (part #10) into the end of the hose that you pushed through the tee and nipple. Push the other end of the barb into the hole of the stopper (part #12). The wide end of the stopper should be nearest the nipple. Pull on the hose until the stopper just rests on the tee. Thread the lower nipple into the flange.
5. Stand the 6 in. 2 x 4 block (part #3) next to the flange. Mark screw holes for three corner braces (part #6). The braces will hold the block in place. One brace goes on each side and one on the side of the block opposite the flange. Drill pilot holes into the base and the block. Screw the block to the base.

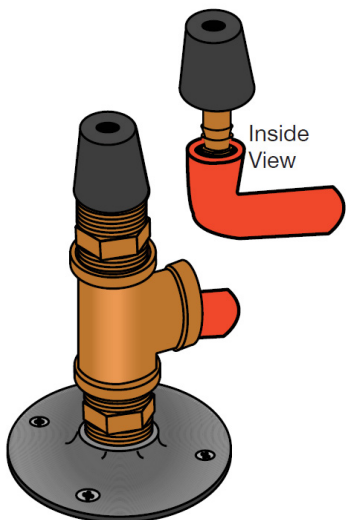

6. Drill two pilot holes into the small block (part #2), laid on its side. The holes should go straight through. Place the block next to the flange opposite the first block. Screw it in place.

7. Push an empty soft drink bottle on to the stopper for alignment of the other parts to be added.

8. Drill a hole in the small block large enough to accept the launch rod (part #4). The hole should be positioned so that the rod will just rest against the side of the bottle.

9. Align the two 8 in. mending plates (part #11) with the bottle lip (just above the cap threads - the bottle is upside down). You will probably have to adjust the height of the stopper. When launching, the bottle neck (rocket nozzle) will have to make a tight seal with the stopper. The mending plates (hold down clamps) press and hold the bottle on the stopper while air is being pumped in. Turn one or both of the nipples to raise or lower the stopper and the bottle to match the clamps with the bottle lip. (The two plates are like vice jaws that pivot sideways against the bottle neck just above the lip.)

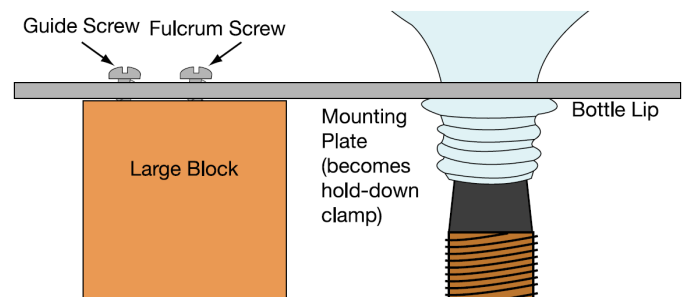

Screws inserted into the second hole (from the back) of each plate serve as fulcrums. The plates pivot inward to grab the bottle. (When the plates are pivoted outward, they release it.) When you are satisfied that the plates will get a good grip on the bottle, mark the positions of the second holes and screw the plates to the upper end of the large block. Screw them in just enough to keep the plates from rocking but not so tight as enough to prevent them from swinging from side to side.

10. Install two guide screws about 3/4 in. apart. The guide screws ensure that both plates open fully and release the bottle. Refer to the diagram to see the positioning of the plates on the 6 in. block.

11. Wrap several rubber bands around the short ends of the clamps. You will have to experiment a bit to get the right tension in the bands to pull the clamps apart for the launch.

12. Thread the hook and loop cable tie (part #14) through the end screw hole of one of the two mounting plates. This permanently attaches the tie to the plate. Tie the launch string to the other end of the tie. The string should be about 4 m long.

13. Connect the bicycle pump or compressor hose to the air hose. Depending upon the kind of pump you have, you may have to obtain a connector to fit the pump. One approach is to install a second barb splicer into the other end of the launcher's air hose. Cut the pump hose and push the barb into it to make the connection. Use small hose clamps to secure the barb to the hose. Other kinds of connectors are available, and some experimentation may be necessary. (One approach is to take the launcher and your pump to the hardware store and ask for recommendations.)

**Top Down View of Hold-Down Clamps**

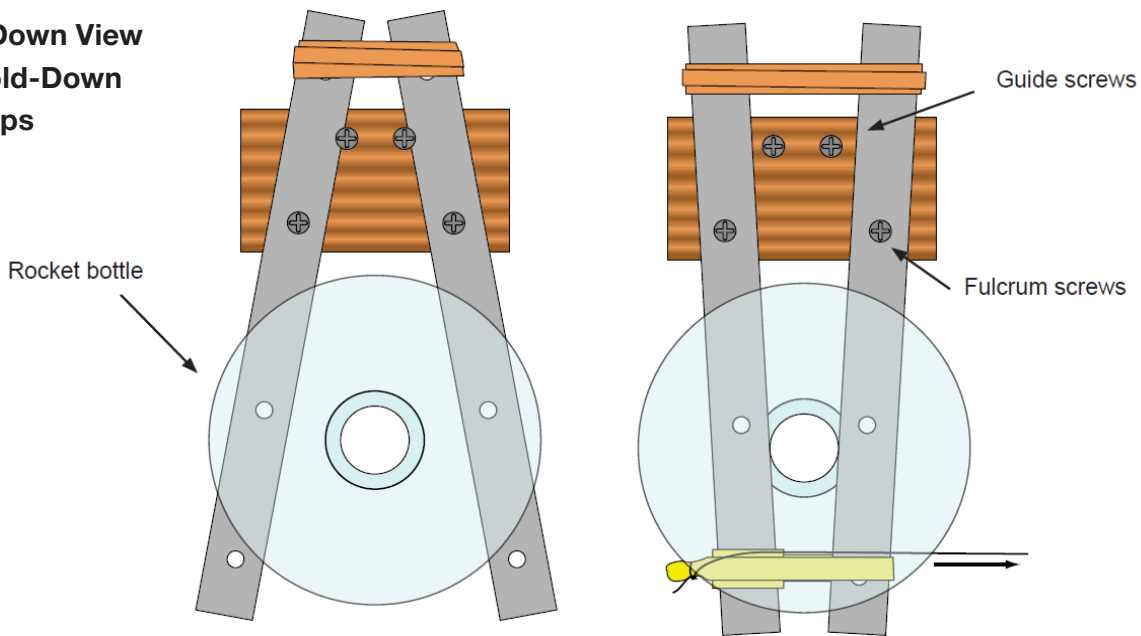

## Placing the hold-down clamps (8 in. mending plates)

The diagram above shows the position of a rocket bottle. The clamps are screwed into the block and are free to swing side-to-side. The guide screws ensure that both clamps open at the same time (not just one opening wide and the other one staying put). When ready for launch, the clamps are swung to the middle to grab on to the bottle neck just above the lip. The diagram to the right shows the hook and loop cable tie wrapped around the clamps. When the string is pulled, the tie is peeled off, and the clamps are released. The rubber bands on the other end of the clamps pull them apart, and the rocket lifts off.

## Tips on Using the Launcher





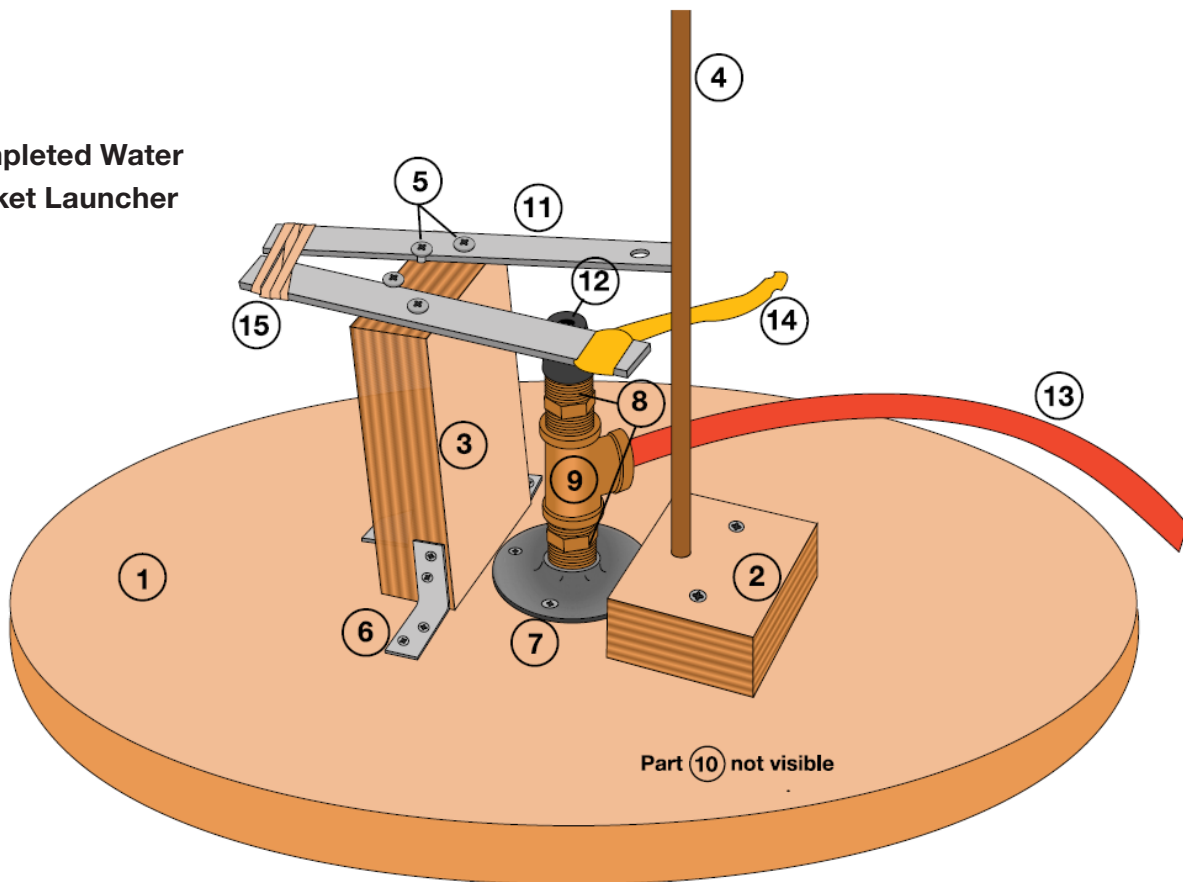

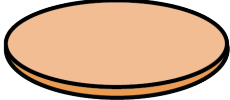
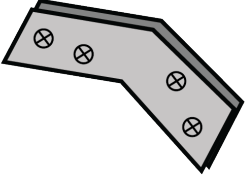
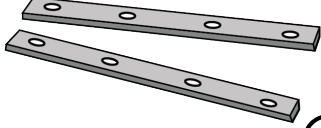
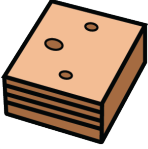

- It is important to keep the bottle sealed with the stopper as it is being pressurized. If the bottle leaks (a small spray comes out as it is being pressurized), the seal is too loose. Raise the stopper by unscrewing one or both of the nipples a turn or two to elevate the stopper.
- New plastic (PET) soft drink bottles are capable of withstanding about 100 or more pounds per square inch (psi) of pressure. A 2 to 1 safety factor is recommended. Do not let students pump the bottle above 50 psi. Bottles can be damaged during the construction process. Also bottles can be damaged on landing. Retire water rockets after 10 flights or sooner if you suspect damage.
- To place a rocket with water inside on the base, hold the rocket horizontally. Tip up the base and push the nozzle onto the stopper. Grasp the bottle with the clamps and hold them in position with the cable wrap. Set the rocket and launch platform level. It is not necessary to anchor the pad on the ground.
- A small pull on the string attached to the cable wrap is enough to peel it back and release the hold-down clamps.
- Students near the launcher should wear eye protection while the rocket is being pressurized and launched.
- Keep other students about 5 to 10 m from the launcher (further if you elect to use higher launch pressures).
- Do not let students attempt to catch their rockets unless the rocket has successfully deployed its parachute.

Completed Water Rocket Launcher

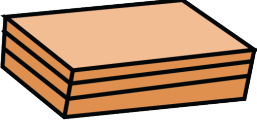
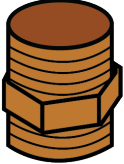

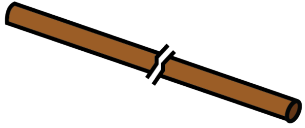

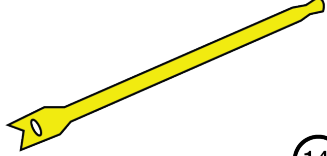
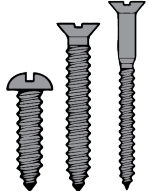
# Shopping List

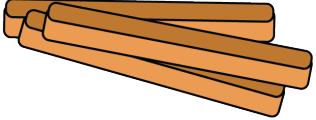
<p><b>1 - Wooden Base</b> (Circle 16 in. diameter or 16 in. square 16 in., plywood or joined lumber, 3/4 in. to 1 1/2 in. thick) Lumber Supply.</p>  <p>1.</p>	<p><b>3 - 1 1/2 in. x 5/8 in. Corner Brace</b> Hardware store.</p>  <p>6.</p>	<p><b>2 - 8 in. Mending Plate with screws</b> Hardware store.</p>  <p>11.</p>
<p><b>1 - 3 in. Wood Block (cut from 2 x 4)</b> Lumber Supply.</p>  <p>Drill pilot screw holes and hole for the dowel (launch rod).</p> <p>2.</p>	<p><b>1 - 1/2 in. Galv FLR Flange with screws</b> Hardware store.</p>  <p>7.</p>	<p><b>1 - Number 3, 1 hole Rubber Stopper</b> School science supply, Some hardware stores.</p>  <p>12.</p>
<p><b>1 - 6 in. Wood Block (cut from 2 x 4)</b> Lumber Supply.</p>  <p>3.</p>	<p><b>2 - 1/2 in. MIP Hex Nipple (Brass)</b> Hardware store.</p>  <p>8.</p>	<p><b>6 - 10' - 1/2 in. O.D. 1/4 in. I.D. High Pressure Air Hose</b> (with connector for bicycle pump/compressor) Hardware Store.</p>  <p>13.</p>
<p><b>1 - 5/16 in. Dowel (36 in. long)</b> Lumber Supply.</p>  <p>4.</p>	<p><b>1 - 1/2 in. Cast Female Pipe Tee (brass)</b> Hardware store.</p>  <p>9.</p>	<p><b>Hook and Loop Cable Tie</b> (e.g., Velcro® One Wrap) Office or Hardware store.</p>  <p>14.</p>
<p><b>4 - #12 pan head metal screws</b> <b>4 - #10 x 3/4 in. wood screws</b> <b>2 - #10 x 2 1/2 in. wood screws</b> Hardware store.</p>  <p>5.</p>	<p><b>1 - 1/4 in. I.D. Barb Splicer (brass)</b></p>  <p>10.</p>	<p><b>#64 Rubber Bands</b> Office Store.</p>  <p>15.</p>

# Rocket Activity

## Water Rocket Construction

### Objectives

Student teams will construct water rockets and successfully launch them.

### Description

Using plastic soft drink bottles, cardboard or Styrofoam food trays, tape, and glue, small teams of students design and construct rockets. A simple assembly stand assists them in gluing fins on their rockets, and a nose cone is mounted on the top. A small lump of modeling clay is inserted into the nose cone to enhance the rocket's stability in flight. The rocket is launched with a special launcher. The plans for the launcher are found in the Water Rocket Launcher activity.

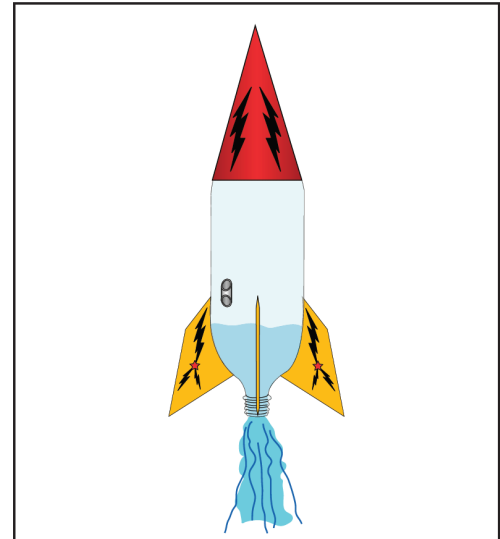

### Materials

- 2-liter soft drink bottle (1 per team)
- Styrofoam food trays
- Posterboard, cardboard
- Masking tape
- Low-temperature glue guns and glue
- 1 - to 2 in. piece of 1/2 in. PVC pipe 4 X 4 X 1 in. board (per team) and small screw and washer
- 4 ounces of clay
- Eye protection
- Plastic grocery sacks or thin fabric scraps
- String
- Sandpaper or emery boards
- Art supplies
- Water rocket launcher (see page 87)
- Bicycle pump or small compressor

### National Science Content Standards

#### Physical Science

- Position and motion of objects
- Motions and forces

#### Science and Technology

- Abilities of technological design

### National Mathematics Content Standards

- Geometry
- Measurement

### National Mathematics Process Standards

- Connections

## Management

Begin collecting 2-liter soft drink bottles a few weeks before the activity. Save the caps, too. Rinse the bottles and remove the labels. There will be some glue adhesive remaining on the bottle. Goo remover can be used to clean it off, but it tends to smear the surface.

Construct assembly stands out of small blocks of wood. Attach a bottle cap to the middle of each board with a small screw and a washer through the cap. When students begin constructing their rockets, they screw the bottle neck into the cap, and the board below will hold the rocket upright for gluing. The blocks also make a convenient way of storing the rockets upright when not being worked on.

Pre-cut the PVC segments. The cuts can be slanted to streamline them. A saw or PVC cutter is used for cutting. The segments act as launch lugs to guide the rocket up the launch rod during the first moments of the rocket's skyward climb.

Be sure to use low temperature glue guns. High temperature guns will melt the plastic bottle. A small dish of ice water in a central location is helpful for students who get hot glue on their fingers. Immersing the fingers will immediately chill the glue. Do not put bowls of water near the guns themselves because the guns use electricity for heating, and shorting could occur if they get wet.

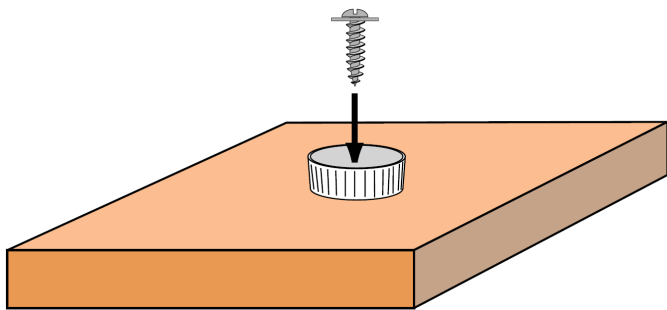

Make mounting stands by screwing the plastic bottle caps to a board. Use a washer for added strength.

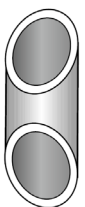

Launch lug with slanted cuts.

## Special Note

The activity entitled *Project X-51* (see page 96) lays out an entire process for constructing water rockets through launch and reporting. Student teams form rocket companies and compete for government contracts. The procedures that follow here should be used for the construction phase of *Project X-51*.

## Background

A water rocket is a chamber, usually a 2-liter soft drink bottle, partially filled with water. Air is forced inside with a pump. When the rocket is released, the pressurized air forces water out the nozzle (pour spout). The bottle launches itself in the opposite direction. The bottle usually has a nose cone for streamlining and fins for stability.

Water rockets are easily capable of 100 m high flights, but advanced hobbyists have combined bottles and staged bottles for flights over 300 meters high.

Water bottle rockets are ideal for teaching Newton's laws of motion. The launch of the rocket easily demonstrates Newton's third law. Students can see the water shooting out of the nozzle (action) and see the rocket streak into the sky (reaction). Students can also experiment with different pressure levels inside the chamber and different amounts of water. The rocket will not fly very high if it is filled only with air. The air will quickly rush out during the launch, but its mass is very low. Consequently, the thrust produced is also low (Newton's second law). By placing water in the bottle, the air has to force the water out first before it can leave the bottle. The water increases the mass expelled by the rocket, thereby increasing the thrust.

Like all rockets, the flight performance of water bottle rockets is strongly influenced by the rocket's design and the care taken in its construction. Beveling the leading and trailing edges of fins allows them to slice through the air more cleanly. Straight-mounted fins produce little friction or drag with the air. A small amount of ballast weight inside the nose cone helps balance the rocket. This moves the center of mass of the rocket forward while still leaving a large fin surface area at the rear. In flight, the rocket design acts like a weather vane, with the nose cone pointed up and the fins down.

## Procedure

1. Set up a supply station with materials such as Styrofoam food trays, posterboard, tape, sandpaper, and art supplies.
2. Set up a gluing station with several heated low-temperature glue guns and extra glue sticks.
3. Divide students into teams for constructing rockets. If using *Project X-51*, describe the project to them and explain its objectives. Discuss construction techniques for their rockets. Give each team an assembly stand and a 2-liter soft drink bottle. *Project X-51* requires teams to keep track of the materials they used. Even if they are not doing the project, it is still good for teams to account for the materials used.

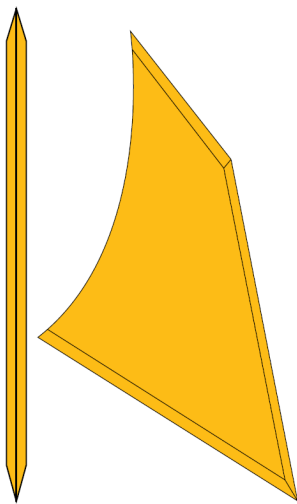

Trim fin edges with sandpaper to give them knife-blade shapes to slice through the air.

4. Show teams how to use the glue guns and point out the cold water dish in case glue gets on fingers. Students should wear Eye protection when gluing.
5. Describe how fins can be smoothed with sandpaper to slice through the air with little drag.
6. Remind teams to add clay to the inside of their nose cones.
7. Have teams glue launch lugs to the side of the rocket midway up the body of the rocket and position it midway between two fins.
8. Challenge teams to think up a way to add a parachute to their rockets for soft landings. Plastic grocery bags or lightweight fabric scraps can be cut to make parachutes and strings can be used to attach them. The nose cone must remain in place until the rocket reaches the top of its flight; then it should open and release the parachute.

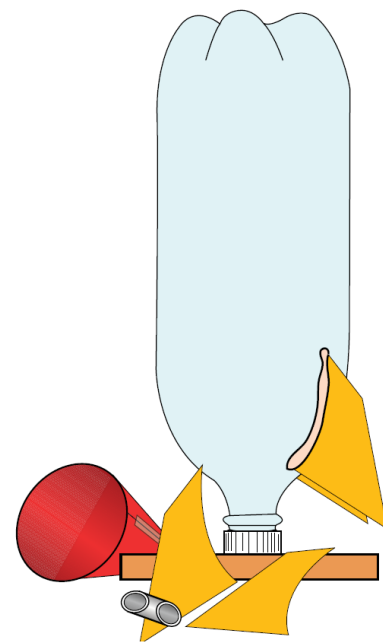
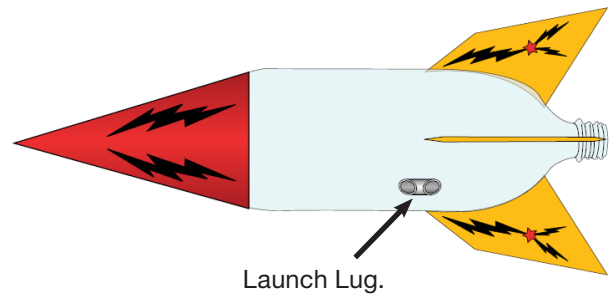

The Assembly Stand supports the rocket while it is being constructed.

9. When the rockets have been completed, have teams qualify their rockets for flight by conducting string tests. Using several feet of string, tie the rocket around the middle so that it balances. Because of the nose cone weight, the balance point will be towards the nose. When the rocket hangs level, a small piece of tape should be temporarily fixed to the string and bottle to keep the string from slipping. The rocket is then twirled in a circle. If the rocket tumbles while circling, it is not stable and needs more nose cone weight, bigger fins, or a combination of both. If the rocket circles with the nose always pointed forward, it is stable and ready for flight. (More information about string tests will be found in the instructions for *Project X-51*.)

10. Review launch procedures with the teams. The instructions are outlined in the activity for constructing a water rocket launcher (see page 87). Conduct an inspection the day before the launch to ensure that rocket fins are securely attached.

11. Set up a tracking station for measuring the altitudes achieved by the rockets. Follow all safety procedures and instructions when launching the team rockets.

## Assessment

Inspect each team's rocket for the construction skill employed. Fins should be vertical and securely attached. The rocket should be stable.

Observe the flights and note how the recovery system designed by teams worked.

## Extensions

Conduct a space art show to feature decorating schemes of team rockets. Have students draw artist's conceptions of their rockets in flight. (See *The Art of Spaceflight* on page 124.) To view artist's conceptions of NASA's new Constellation program, see pages 13 – 19.

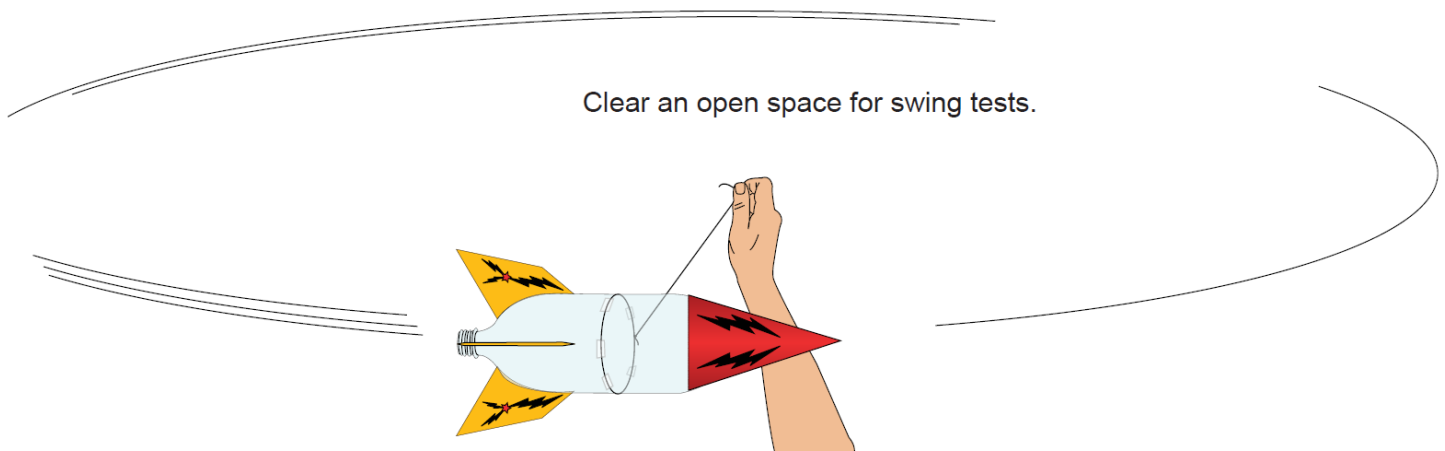

# Rocket Activity

## Project X - 51

### Objectives

To apply rocket principles and design, construct, test, and launch a water rocket using a real world problem-solving simulation.

### Description

Teams of students will form rocket companies and compete in a commercial endeavor to construct rockets capable of launching payloads, astronaut crews, and even space tourists to Earth orbit. Through a strong interdisciplinary approach, balancing science with technology, engineering, and mathematics, they will develop a budget, purchase construction materials, and track expenditures while designing and constructing their rocket. They will then have to test the rocket for stability and fill out specification sheets. Finally, the teams will launch their rockets and conduct a cost/benefit (altitude vs. cost) ratio.

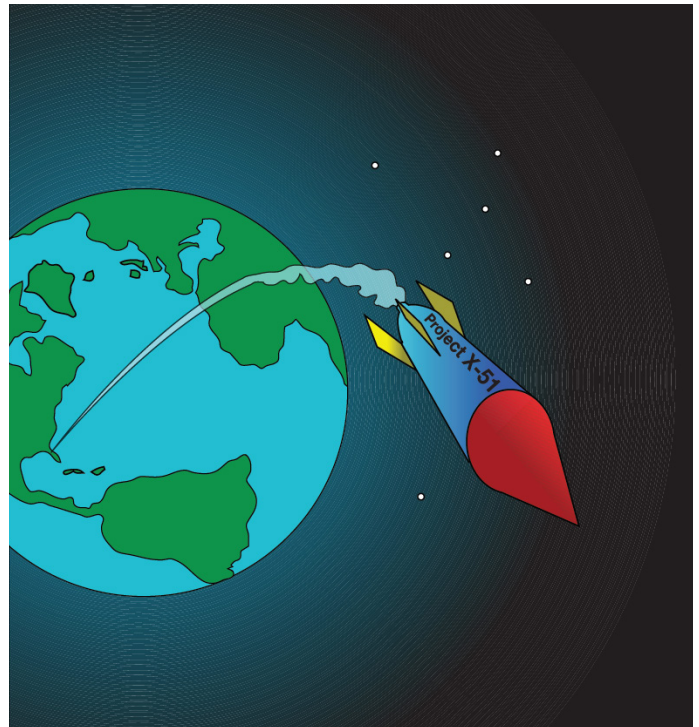

### National Science Content Standards

#### Unifying Concepts and Processes

- Evidence, models, and explanation
- Change, constancy, and measurement

#### Science as Inquiry

- Abilities necessary to do scientific inquiry

#### Physical Science

- Position and motion of objects
- Motions and forces

#### Science and Technology

- Abilities of technological design

#### Science in Personal and Social Perspectives

- Risks and benefits
- Science and technology in local challenges

### National Mathematics Content Standards

- Number and Operations
- Geometry
- Measurement
- Data Analysis and Probability

### National Mathematics Process Standards

- Problem Solving
- Reasoning and Proof
- Communication
- Connections

## Materials

(All supplies need to be available for each group.)

- 2-liter soft drink bottle
- 1-liter water bottle
- 1 1 in. long by 3/4 in. diameter PVC segment
- Aluminum soft drink can
- Scrap cardboard, poster board, and tag board
- Large cardboard panels (about 3 X 1 feet) for silhouettes
- Duct tape
- Masking tape
- Glue stick
- Low-temperature glue gun
- Modeling clay
- Plastic grocery bag or garbage bag
- String
- Art supplies
- (The following are needed for launch day.)
- Water rocket launcher (see page 87)
- Eye protection
- Altitude tracker (see page 81)
- Tape measure
- Water

## Management

Prior to this project students should have the opportunity to design, construct, and launch water rockets using different water volumes and pressures to see the effect these variables have on the altitude. Students should also become proficient in altitude tracking. (See article on page 119.) Doing so will prepare them to employ Newton's laws of motion to maximize the flight properties of their rockets.

Divide your students into teams of three. They will form competing rocket companies in a request for proposal, issued by NASA. Their objective is to construct the best payload/crew/space tourist orbital transport rocket. The team will select roles for each member: Project Manager, Budget Director, and Design and Launch Director. One of the student pages that follows contains badges for each student. The back side of the badges explain the duties for each job. Take digital head shot pictures of each student and print them. Have students trim the pictures and paste them on to their badges prior to laminating them.

The project takes approximately two weeks to complete and includes a daily schedule of tasks. Students may need additional time to complete daily tasks and keep on schedule.

Collect all building materials and copy all reproduces before beginning the activity. Make several copies of the order forms and blank checks for each group.

Allow enough time on the first day for students to read and discuss all sheets and determine how the sheets apply to the project schedule. Focus on the student score sheet to make sure students understand the criteria used to assess their performance.

By the end of the first day, teams should have decided on the roles each member will play, the name of the company, and started their rocket design.

## Background

From the beginning of the space program, rockets, spacecraft, spacesuits, launch platforms, and much more have been built by contractors. The responsibility of the National Aeronautics and Space Administration (NASA) has been to manage the exploration of the atmosphere and space.

When a particular space mission is decided upon, requests for proposals are issued to American industry to build the hardware. Corporate teams propose designs for rockets, space capsules, or whatever else NASA needs for its mission. After a competitive process, the winning corporation is chosen and money is awarded to begin construction. Often, when very large contracts are awarded, the winning companies will select other companies as subcontractors to build component systems. This contracting strategy has worked successfully for NASA for more than 50 years.

The International Space Station is critical for NASA to understand and overcome the challenges of long-duration spaceflight necessary for the journey to Mars. By encouraging industry to provide human transportation services to and from low-Earth orbit, NASA can expand its focus on building spacecraft (Orion) and rockets (SLS) for deep space missions.

NASA's Commercial Resupply Services Program is an initiative changing the way NASA does business, helping build a strong American commercial space industry, and freeing the agency to focus on the systems that will allow travel farther into space than ever before. SpaceX began successfully resupplying the space station with cargo in 2012 and Northrop Grumman (known as Orbital Sciences at the time) followed in 2014.

NASA's Commercial Crew Program is working with American aerospace companies The Boeing Company and SpaceX to develop and operate a new generation of spacecraft and launch systems capable of carrying crews to low-Earth orbit and the International Space Station. Commercial transportation to and from the station will provide expanded utility, additional research time, and broader opportunities of discovery on the orbiting laboratory. SpaceX had the first successful crewed flight for the Commercial Crew Program in May 2020.

## Procedure

Refer to the student sheets and the project schedule for details on specific tasks and when they should be performed. The project schedule calls for teacher demonstration on how to make nose cones on day 3 and how to determine the center of pressure and center of mass on day 6.

## Discussion

- What did you learn about running a company? How might you have done things differently? What was the most difficult part of the two weeks? What do you understand now that you were not sure or aware of before?
- Why is NASA supporting the development of private launch vehicles?

## Assessment

Base the assessment of team performance on their documentation: Project Journal, Silhouette, and Launch Results. Refer to the *Project X-51 Score Sheet* for details.

## Extensions

- Large space missions often require a wide range of subcontractors across the United States to provide the expertise needed to build the launch and vehicle systems. Learn about the contributions contractors in your state make towards the exploration of outer space. A good place to start is with the Space Grant Consortium for your state. Consortium members (colleges and universities) promote space research and educational activities in their home states and work with local space industries. The following website contains an interactive listing of Space Grant programs by state:  
[http://www.nasa.gov/offices/education/programs/national/spacegrant/home/Space\\_Grant\\_Directors.html](http://www.nasa.gov/offices/education/programs/national/spacegrant/home/Space_Grant_Directors.html)



# Request for Proposal

The National Aeronautics and Space Administration is seeking competitive bids for an advanced rocket capable of launching large payloads and crew to Earth orbit at low cost. The International Space Station needs continual crew and cargo resupply flights. NASA will also need massive amounts of rocket fuel and other supplies for future deep space missions transported to orbit. The winning company will design and test a rocket capable of transporting supplies and crew to space at the best cost. As an added bonus, the rockets developed will also be ideal for use in space tourism. The winning company will be awarded a \$100,000,000 development contract. Interested companies are invited to submit proposals to NASA for a rocket capable of meeting the objectives below.

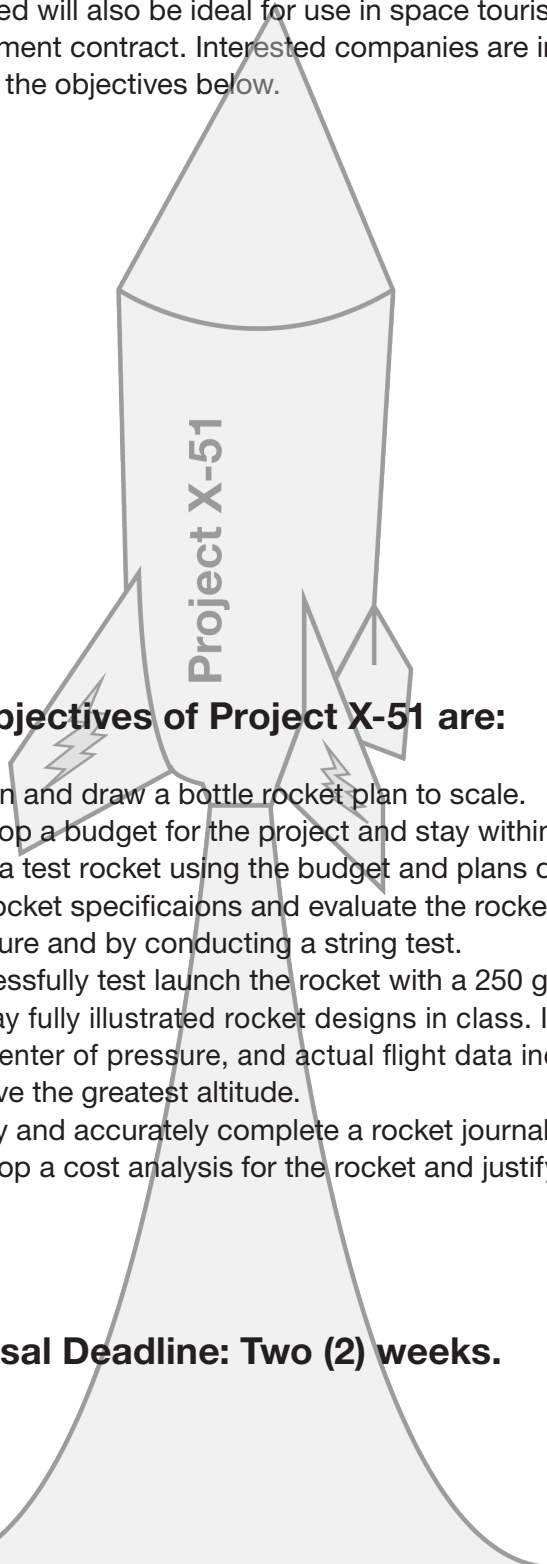

## The objectives of Project X-51 are:

- a. Design and draw a bottle rocket plan to scale.
- b. Develop a budget for the project and stay within the allotted funds.
- c. Build a test rocket using the budget and plans developed by the team.
- d. List rocket specifications and evaluate the rocket's stability by determining its center of mass and center of pressure and by conducting a string test.
- e. Successfully test launch the rocket with a 250 gram payload of simulated fuel.
- f. Display fully illustrated rocket designs in class. Include dimensional information, location of center of mass and center of pressure, and actual flight data including time aloft and altitude reached. Launch the rocket to achieve the greatest altitude.
- g. Neatly and accurately complete a rocket journal.
- h. Develop a cost analysis for the rocket and justify its economic benefits.

**Proposal Deadline: Two (2) weeks.**

# Project Schedule

Project X-51 Schedule  
**Day 1**

- Form rocket companies.
- Pick company officers.
- Brainstorm ideas for design and budget.
- Sketch preliminary rocket design.

Project X-51 Schedule  
**Day 2**

- Develop materials and budget list.
- Develop scale drawing.

Project X-51 Schedule  
**Day 3**

- Demonstration: nose cone construction.
- Issue materials and begin construction.

Project X-51 Schedule  
**Day 4**

- Continue construction.

Project X-51 Schedule  
**Day 5**

- Continue construction.

Project X-51 Schedule  
**Day 6**

- Demonstration: Find center of mass and center of pressure.
- Introduce rocket silhouette construction and begin rocket analysis.

Project X-51 Schedule  
**Day 7**

- Finish silhouette construction and complete prelaunch analysis. Hang silhouette.
- Perform swing test.

Project X-51 Schedule  
**Day 8**

- Launch Day!

Project X-51 Schedule  
**Day 9**

- Complete post launch results, silhouette documentation.
- Prepare journal for collection.
- Documentation and journal due at beginning of class tomorrow.

# Project X-51 Checklist

## Project Grading:

50% Documentation - See Project Journal below. Must be complete and neat.

25% Proper display and documentation of rocket silhouette.

25% Launch data - Measurements, accuracy, and completeness.

## Project Awards:

USA will award exploration contracts to the companies with the top three rocket designs based on the above criteria. The awards are valued at:

**First \$100,000,000**

**Second \$50,000,000**

**Third \$30,000,000**

## Project Journal:

Check off items as you complete them.

1. Creative cover with members' names, date, project number and company name.

2. Certificate of Assumed Name (registration of the name of your business).

3. Scale drawing of rocket plans. Clearly indicate scale. Label: Top, Side, and End views.

4. Budget Projection.

5. Balance Sheet.

6. Canceled checks. Staple checks on a page in ascending numerical order (3 to a page).

7. Pre-Launch Analysis.

8. Rocket Launch Day Log.

9. Score Sheet (part 3).

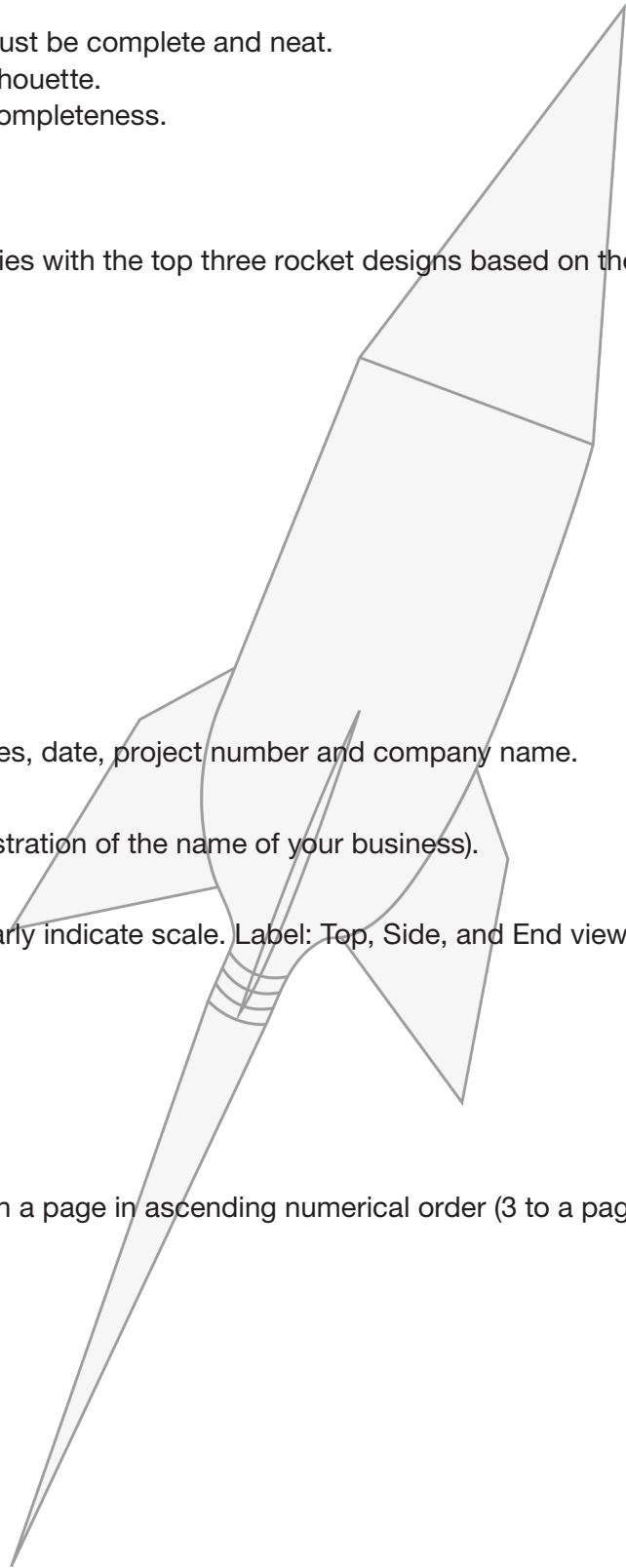

# Badges

Each team member will be assigned specific tasks to help their team function successfully. All team members assist with design, construction, launch, and paperwork. Print the badges and fold them on the dashed lines. Take digital pictures of the teams and paste head shot prints inside the boxes on the front of the badges. Laminate the badges and provide string loops or clips for wearing them.

Cut Out

## X-51

### Design and Launch Director

- Supervises design and construction of rocket. Directs others during launch.
- Submit neat copy of the rocket scale drawing.
- Conduct String Test.
- Record and submit neat copy of the Launch Day Log.
- Arrange for creative report cover.
- Complete silhouette information and display properly in room.
- Assist other team members as needed.

Cut Out

## X-51

### Budget Director

- Keeps accurate account of money and expenses and pays bills. Must sign all checks.
- Arrange all canceled checks in ascending numerical order and staple three to a sheet of paper.
- Check over budget projection sheet. Be sure to show total project cost estimates.
- Check over balance sheet. Be sure columns are complete and indicate a positive or negative balance.
- Co-sign all checks.
- Complete part 3 of the score sheet.
- Assist other team members as needed.

Cut Out

## X-51

### Project Manager

- Overses the project. Keeps others on task. Only person who can communicate with the teacher.
- Make a neat copy of the team's Rocket Journal.
- Use appropriate labels as necessary.
- Check balance sheet and list of all materials used in rocket construction.
- Co-sign all checks.
- Assist other team members as needed.

State of: \_\_\_\_\_

## Certificate of Assumed Name

A filing fee of \$50.00 must accompany this form.  
Make out the check to "Registrar."

Filing Date: \_\_\_\_\_ , 20 \_\_\_\_\_

Project  
Number:

State the exact assumed name under which the business will be conducted:

\_\_\_\_\_

List the name of the officers of the business:

Project Manager \_\_\_\_\_

Budget Manager \_\_\_\_\_

Design and Launch Director \_\_\_\_\_

Describe the product of your business:

# Project X-51 Budget

Your team will be given a budget of \$1,000,000. Use the money wisely, plan well, and keep accurate records of all expenditures. Once your money runs out, you will operate in the “red.” This will count against your team score. If you are broke at the time of the launch, you will be unable to purchase rocket fuel. You will then be forced to launch with compressed air only. You may purchase only as much rocket fuel as you can afford at the time of the launch.

All materials not purchased from the listed subcontractors will be assessed an import duty tax of 20% of the market value. Materials not on the subcontractors list will be assessed an Originality Tax of \$5,000.00 per item.

A project delay penalty fee will be assessed for not working on task, lacking materials, etc. The maximum penalty is \$300,000 per day.

Approved Subcontractor List		
Subcontractor	Item	Market Price
Bottle Engine Corporation	2-liter bottle/launch guide	\$200,000
	1-liter bottle/launch guide	\$150,000
Aluminum Cans Ltd.	Can	\$50,000
International Paper Products	Cardboard - 1 sheet	\$25,000
	Tagboard - 1 sheet	\$30,000
	Colored paper - 3 sheets	\$40,000
	Crepe paper - 1 strip	\$10,000
	Silhouette panel - 1 sheet	\$100,000
International Tape and Glue Co.	Duct tape (50 cm strip)	\$50,000
	Masking tape (100 cm strip)	\$50,000
	Glue stick	\$20,000
Aqua Rocket Fuel Service	1 ml	\$300
Strings Inc.	1 m	\$5,000
Plastic Sheet Goods	1 bag	\$5,000
Common Earth Corporation	Modeling clay - 100 gm	\$5,000
NASA Launch Port (rental)	Launch	\$100,000
NASA Consultation	Question	\$1,000

Company Name: \_\_\_\_\_

## Project X-51 Purchase Order Form

Date: \_\_\_\_\_, 20\_\_\_\_ Check No. \_\_\_\_\_ P.O. No. \_\_\_\_\_

Supply Company Name: \_\_\_\_\_

Items Ordered:	Quantity	Unit Price	Cost
		_____.	_____.
		_____.	_____.
		<b>Total</b>	_____.

Budget Director's Signature: \_\_\_\_\_

Company Name: \_\_\_\_\_

## Project X-51 Purchase Order Form

Date: \_\_\_\_\_, 20\_\_\_\_ Check No. \_\_\_\_\_ P.O. No. \_\_\_\_\_

Supply Company Name: \_\_\_\_\_

Items Ordered:	Quantity	Unit Price	Cost
		_____.	_____.
		_____.	_____.
		<b>Total</b>	_____.

Budget Director's Signature: \_\_\_\_\_

Company Name: \_\_\_\_\_

## Project X-51 Purchase Order Form

Date: \_\_\_\_\_, 20\_\_\_\_ Check No. \_\_\_\_\_ P.O. No. \_\_\_\_\_

Supply Company Name: \_\_\_\_\_

Items Ordered:	Quantity	Unit Price	Cost
		_____.	_____.
		_____.	_____.
		<b>Total</b>	_____.

Budget Director's Signature: \_\_\_\_\_

# Project X-51 Budget Projection

Company Name: \_\_\_\_\_

Record below all expenses your company expects to incur in the design, construction, and launch of your rocket.

Item	Supplier	Quantity	Unit Cost:	Total Cost:
			_____ .	_____ .
			_____ .	_____ .
			_____ .	_____ .
			_____ .	_____ .
			_____ .	_____ .
			_____ .	_____ .
			_____ .	_____ .
			_____ .	_____ .
			_____ .	_____ .
			_____ .	_____ .
			_____ .	_____ .
			_____ .	_____ .
			_____ .	_____ .
			_____ .	_____ .
			_____ .	_____ .
			_____ .	_____ .
			_____ .	_____ .

Projected Total Cost \_\_\_\_\_ .



Keep this stub for your records

Check No: \_\_\_\_\_

Date: \_\_\_\_\_, 20 \_\_\_\_\_

To: \_\_\_\_\_

For: \_\_\_\_\_

Amount:  
\$

**Company Name:** \_\_\_\_\_ Check No. \_\_\_\_\_

**Date:** \_\_\_\_\_, 20 \_\_\_\_\_

**Pay to the Order of:** \_\_\_\_\_ \$

\_\_\_\_\_ **Dollars**

 **National Space Bank**

**Project Manager Signature:** \_\_\_\_\_

**Budget Director Signature:** \_\_\_\_\_

**For:** \_\_\_\_\_

⑆ 30109932 ⑆ 0295110 ⑆ 175

Keep this stub for your records

Check No: \_\_\_\_\_

Date: \_\_\_\_\_, 20 \_\_\_\_\_

To: \_\_\_\_\_

For: \_\_\_\_\_

Amount:  
\$

**Company Name:** \_\_\_\_\_ Check No. \_\_\_\_\_

**Date:** \_\_\_\_\_, 20 \_\_\_\_\_

**Pay to the Order of:** \_\_\_\_\_ \$

\_\_\_\_\_ **Dollars**

 **National Space Bank**

**Project Manager Signature:** \_\_\_\_\_

**Budget Director Signature:** \_\_\_\_\_

**For:** \_\_\_\_\_

⑆ 30109932 ⑆ 0295110 ⑆ 175

Keep this stub for your records

Check No: \_\_\_\_\_

Date: \_\_\_\_\_, 20 \_\_\_\_\_

To: \_\_\_\_\_

For: \_\_\_\_\_

Amount:  
\$

**Company Name:** \_\_\_\_\_ Check No. \_\_\_\_\_

**Date:** \_\_\_\_\_, 20 \_\_\_\_\_

**Pay to the Order of:** \_\_\_\_\_ \$

\_\_\_\_\_ **Dollars**

 **National Space Bank**

**Project Manager Signature:** \_\_\_\_\_

**Budget Director Signature:** \_\_\_\_\_

**For:** \_\_\_\_\_

⑆ 30109932 ⑆ 0295110 ⑆ 175

# Project X-51 Balance Sheet

Company Name: \_\_\_\_\_

**Check No.**      **Date:**      **To:**      **Amount:**      **Balance:**

Check No.	Date:	To:	Amount:	Balance:
			_____ .	_____ .
			_____ .	_____ .
			_____ .	_____ .
			_____ .	_____ .
			_____ .	_____ .
			_____ .	_____ .
			_____ .	_____ .
			_____ .	_____ .
			_____ .	_____ .
			_____ .	_____ .
			_____ .	_____ .
			_____ .	_____ .
			_____ .	_____ .
			_____ .	_____ .
			_____ .	_____ .
			_____ .	_____ .
			_____ .	_____ .
			_____ .	_____ .
			_____ .	_____ .
			_____ .	_____ .

# Rocket Measurements for Scale Drawing

Date: \_\_\_\_\_ , 20 \_\_\_\_\_

Project No.

Company Name: \_\_\_\_\_

Use metric measurements to measure and record the data in the blanks below. Be sure to accurately measure all objects that are constant (such as bottles) and those you will control (like the size and design of fins). If additional data lines are needed, use the back of this sheet. Mark "NA" in columns that don't apply to the object being measured. For example, diameter and circumference do not apply to fin measurement.

Object	Length	Width	Diameter	Circumference

Using graph paper, draw side, top, and bottom views of your rocket to scale (1 square = 2cm), based on the measurements recorded above. Attach your drawings to this paper. If you make changes during construction, your scale drawing and measurement sheet should reflect them.

# Project X-51 Scale Drawing

Company Name: \_\_\_\_\_

Scale: 1 square = 2 centimeters

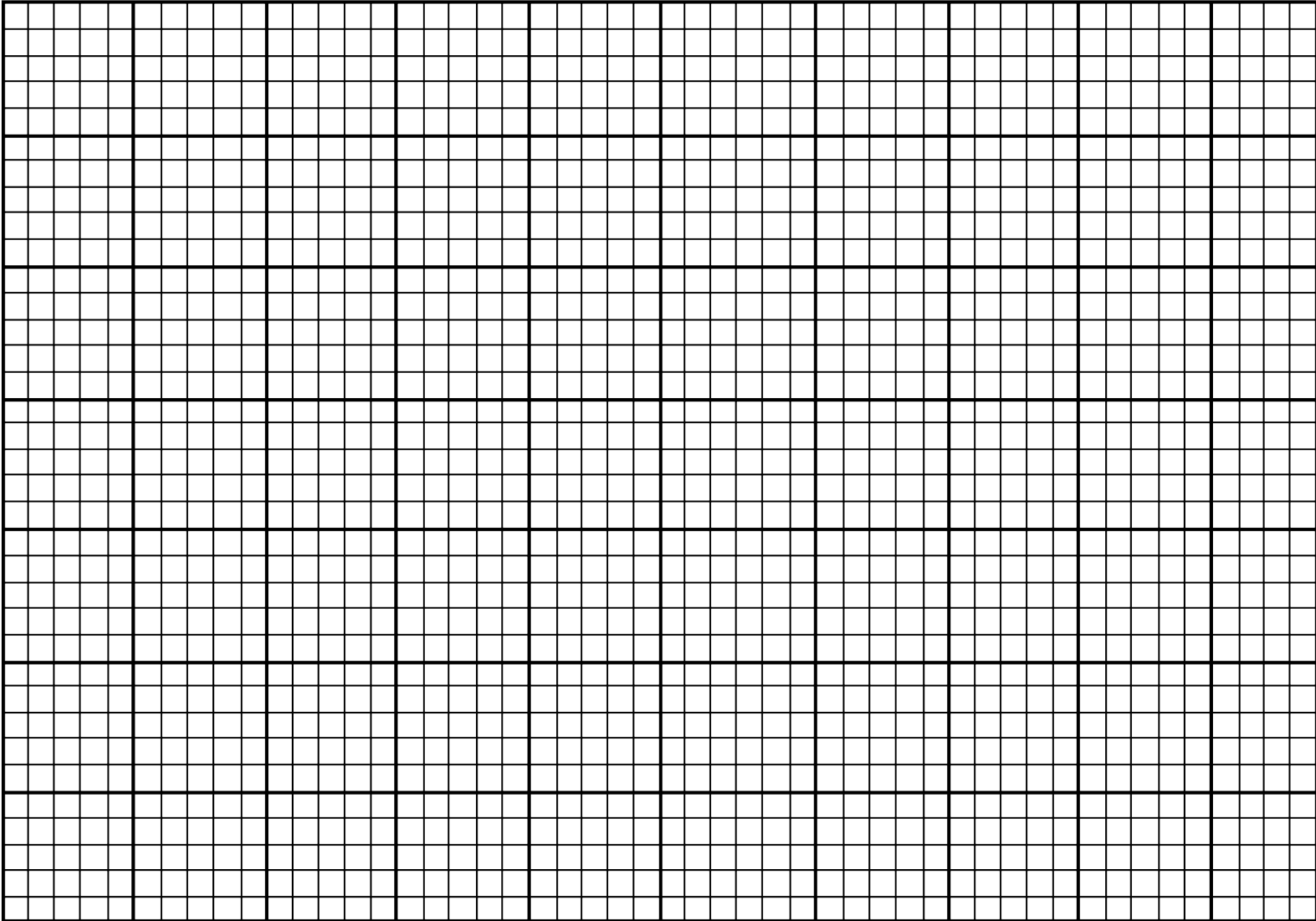

# Rocket Stability Determination

## (Swing Test)

A rocket that flies straight through the air is said to be stable. A rocket that veers off course or tumbles is said to be unstable. Whether a rocket is stable or unstable depends upon its design.

All rockets have two “centers.” The first is the center of mass. This is a point about which the rocket balances. The picture to the right shows a rocket suspended from a string. The rocket is hanging horizontal. That means that it is balanced. The string is positioned exactly beneath the rocket’s center of mass. (This rocket looks like it should really hang with its tail section downward. What you can’t see in the picture is a mass of clay placed in the rocket’s nose cone. This gives the left side as much mass as the right side. Hence, the rocket balances.)

The center of mass is important to a rocket. If the rocket is unstable, it will tumble around the center of mass in flight the way a stick tumbles when you toss it.

The other “center” of a rocket is the center of pressure. This is a point in the shape of the rocket where half of the surface area of the rocket is on one side and half on the other. The center of pressure is different from the center of mass in that its position is not affected by what is inside the rocket. It is only based on the rocket’s shape.

Air strikes the surface of the rocket as the rocket moves. You know what this is like. If you stick your arm outside a car window when it is moving, you feel pressure from the air striking your arm. The center of pressure of a rocket is the middle point. Half of the total pressure on the rocket is on one side of the point and half on the other.

Depending upon the design of the rocket, the center of mass and the center of pressure can be in different places. When the center of mass is in front of the center of pressure (towards the nose end), the rocket is stable. When the center of pressure is towards the front, the rocket is unstable.

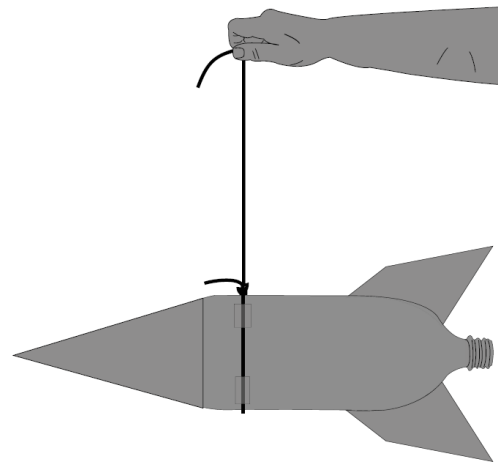

When designing a stable rocket, the center of mass must be to the front and the center of pressure must be to the rear.

A simple way to accomplish stability is to place fins at the rear of the rocket and place extra mass in the nose. Look at the rockets below. One of them is stable and the others are not. The center of mass is shown with a black dot. The center of pressure is shown with a red dot. Which rocket will fly on course?

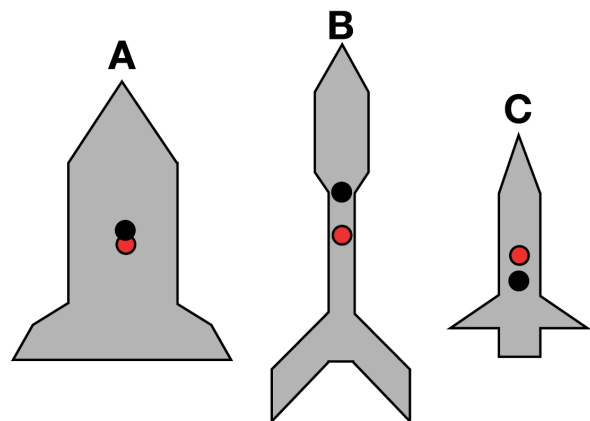

Rocket B is the most stable rocket. Rocket C will definitely tumble in flight. Rocket A will probably fly on a crooked path. Any cross winds encountered by the rocket as it climbs will cause it to go off course.

## How to Determine Your Rocket's Stability

1. Draw a scale diagram of your rocket on the graph paper. Make it exactly like the shape of your rocket as seen from the side.

2. Tie a string loop snugly around your rocket so that you have one long end to hold. Except for the water needed for launch, your rocket should be set up exactly as it will be during launch.

3. Slide the loop until the rocket hangs horizontally. When it hangs horizontally, the string is at the rocket's center of mass. Mark that spot in the middle of your rocket on the scale diagram. Use a black dot.

4. Cut out a silhouette of your rocket from a piece of cardboard. Make it exactly the same shape and size of your rocket as seen from the side.

5. Balance the silhouette on the edge of a ruler. The center of pressure of your rocket is where the ruler is located. Mark that spot in the middle of your rocket on the scale diagram. Use a red dot.

6. If the center of pressure is before (towards the rocket's nose) the center of mass, add some additional clay to the rocket OR increase the size of the fins. Repeat the tests until the center of mass is in front.

7. Verify your design results by conducting a swing test. Balance the rocket again with the string. Use a couple of pieces of masking tape to hold the string loop in position. Stand in a clear area and slowly start the rocket swinging in a circle. If the rocket is really stable, it will swing with its nose forward and the tail to the back.

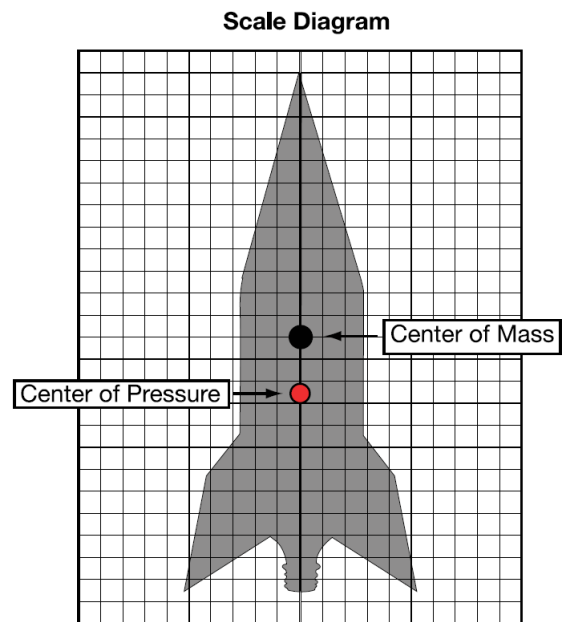
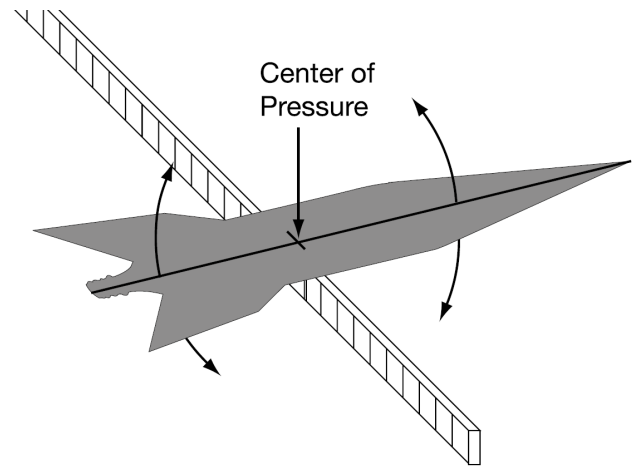

In flight, the rocket will try to tumble around its center of mass. If the center of pressure is properly placed, the rocket will fly straight instead. More air pressure will be exerted on the lower end of the rocket than on the upper end. This keeps the lower end down and the nose pointed up!

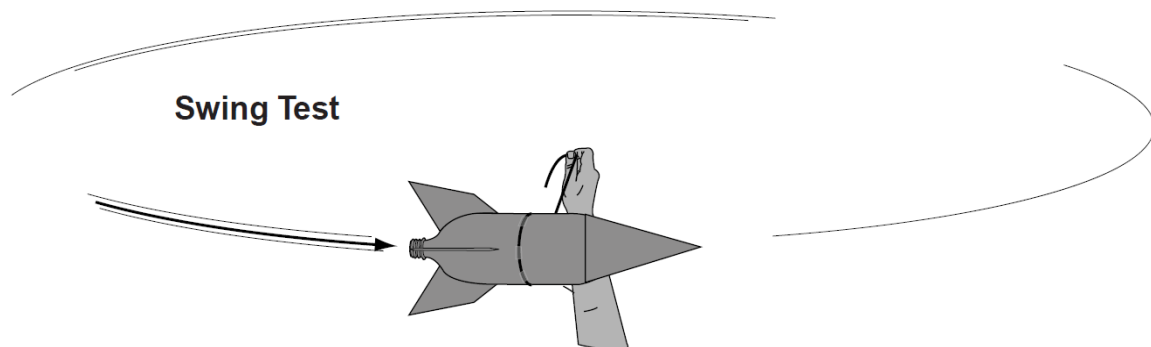



## Pre-Launch Analysis

Company Name: \_\_\_\_\_ Project No.

Project Manager: \_\_\_\_\_

Design and Launch Director: \_\_\_\_\_

Budget Director: \_\_\_\_\_

---

## Rocket Specifications

Total Mass: \_\_\_\_\_ g

Number of Fins: \_\_\_\_\_

Total Length: \_\_\_\_\_ cm

Length of Nose Cone: \_\_\_\_\_ cm

Width (widest part): \_\_\_\_\_ cm

Volume of Rocket Fuel (H<sub>2</sub>O) to be

Circumference: \_\_\_\_\_ cm

used on launch day: \_\_\_\_\_ ml

---

## Rocket Stability

**Center of Mass (CM)**

**Center of Pressure (CP)**

Distance from Nose: \_\_\_\_\_ cm

\_\_\_\_\_ cm

Distance from Tail: \_\_\_\_\_ cm

\_\_\_\_\_ cm

Distance of CM from CP: \_\_\_\_\_ cm

Did your rocket pass the string test?

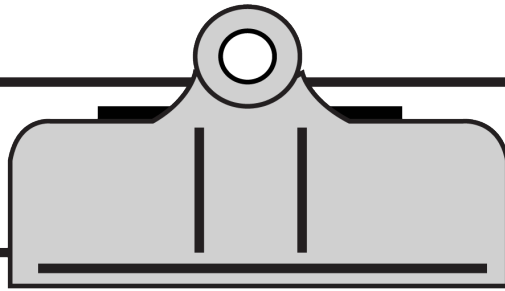

## Flight Day Log

Date: \_\_\_\_\_, 20 \_\_\_\_\_  
Project No.  Time: \_\_\_\_\_  
Company Name: \_\_\_\_\_  
Launch Director: \_\_\_\_\_  
Weather Conditions: \_\_\_\_\_  
\_\_\_\_\_

Wind Speed: \_\_\_\_\_ mph Wind Direction: \_\_\_\_\_  
Air Temperature: \_\_\_\_\_ °C

Launch Location: \_\_\_\_\_  
Launch Angle (degrees): \_\_\_\_\_ Launch Direction: \_\_\_\_\_

Fuel (Water) Volume: \_\_\_\_\_ ml Pressure: \_\_\_\_\_ psi

Altitude Reached: \_\_\_\_\_ M

Evaluate your rocket's performance:

Recommendations for future flights:



# Project X-51 Score Sheet

Total Score:

Project No. \_\_\_\_\_

Date: \_\_\_\_\_, 20 \_\_\_\_\_

Company Name: \_\_\_\_\_

## Part 1: Documentation = 50% of project grade

Neatness \_\_\_\_\_ Completeness \_\_\_\_\_

Accuracy \_\_\_\_\_ Order \_\_\_\_\_

On Time \_\_\_\_\_ Score:

## Part 2: Silhouette = 25% of project grade

Neatness \_\_\_\_\_ Completeness \_\_\_\_\_

Accuracy \_\_\_\_\_ Proper Balance \_\_\_\_\_

Correct use of labels \_\_\_\_\_ Score:

## Part 3: Launch Results = 25% of project grade (teams complete this section)

a. Rocket Altitude \_\_\_\_\_ Rank \_\_\_\_\_

b. Expenditures and Penalty Fees \_\_\_\_\_  
(Check total from Balance Sheet)

c. Final Balance \_\_\_\_\_  
(New Balance on Balance Sheet)

d. Efficiency (Cost/meter) \_\_\_\_\_  
(Divide investment (b) by Rocket Altitude (a))

e. Contract Award \_\_\_\_\_

f. Profit \_\_\_\_\_  
(Contract Award (e) minus Expenditures (b))

Score:

# ACHIEVEMENT AWARD

*Be it known that* \_\_\_\_\_

*has mastered the Science, Technology, Engineering, and Mathematics of rocketry and is now a*

**ROCKET SCIENTIST**

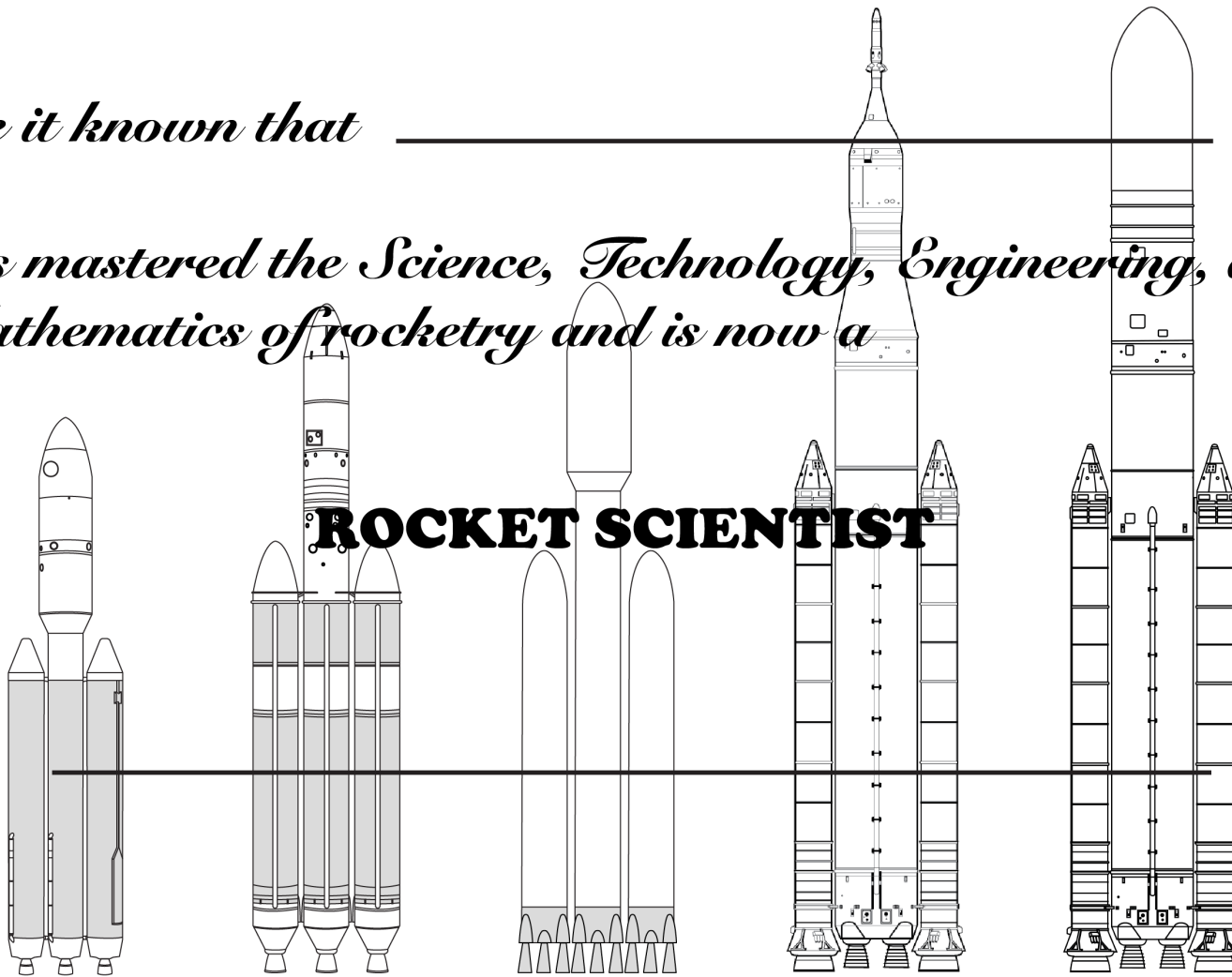

## It Takes a Community to Explore Space

Aerospace Engineer	Electrical Engineer	Physicist
Architect	Environmental Scientist	Public Affairs Specialist
Astronaut	Geographer Geologist	Robotics Engineer Safety and Occupational Health Specialist
Astronomer	Materials Engineer	Simulation Specialist
Biologist	Mechanical Engineer	Teacher
Chemical Engineer	Meteorologist Mission Controller Nurse	Technician
Chemist Communications	Oceanographer	Test Pilot
Engineer Computer		Wildlife Biologist
Engineer Dietician		
Doctor		

**See a job that looks interesting? Want to joint the team? All these careers and many more are needed to explore space.**

NASA and the companies that build rockets and spacecraft are always on the lookout for future scientists, technicians, engineers, and mathematicians. They need people who can plan, design, build, manage, and fly missions throughout the Solar System. Big rockets and spacecraft are comprised of many integrated systems. People, working together, build spacesuits, prepare space food, construct energy and environmental systems, program computers, and train flight crews. Doctors keep the astronauts healthy on the ground and in space. Technicians prepare the launch pads, pack booster parachutes, and process payloads.

Visit some of the Internet sites below. They list current NASA job openings, help future aerospace workers plan their education, and tell about opportunities available to students. Also check out the opportunities available on the Internet sites of private space companies that launch space tourists, satellites, and build heavy-lift rockets for transporting cargo to orbit.

**NASA Internships – <https://intern.nasa.gov/>**

**NASA People – [www.nasa.gov/about/people](http://www.nasa.gov/about/people)**

**Careers @ NASA – [www.nasa.gov/careers](http://www.nasa.gov/careers)**

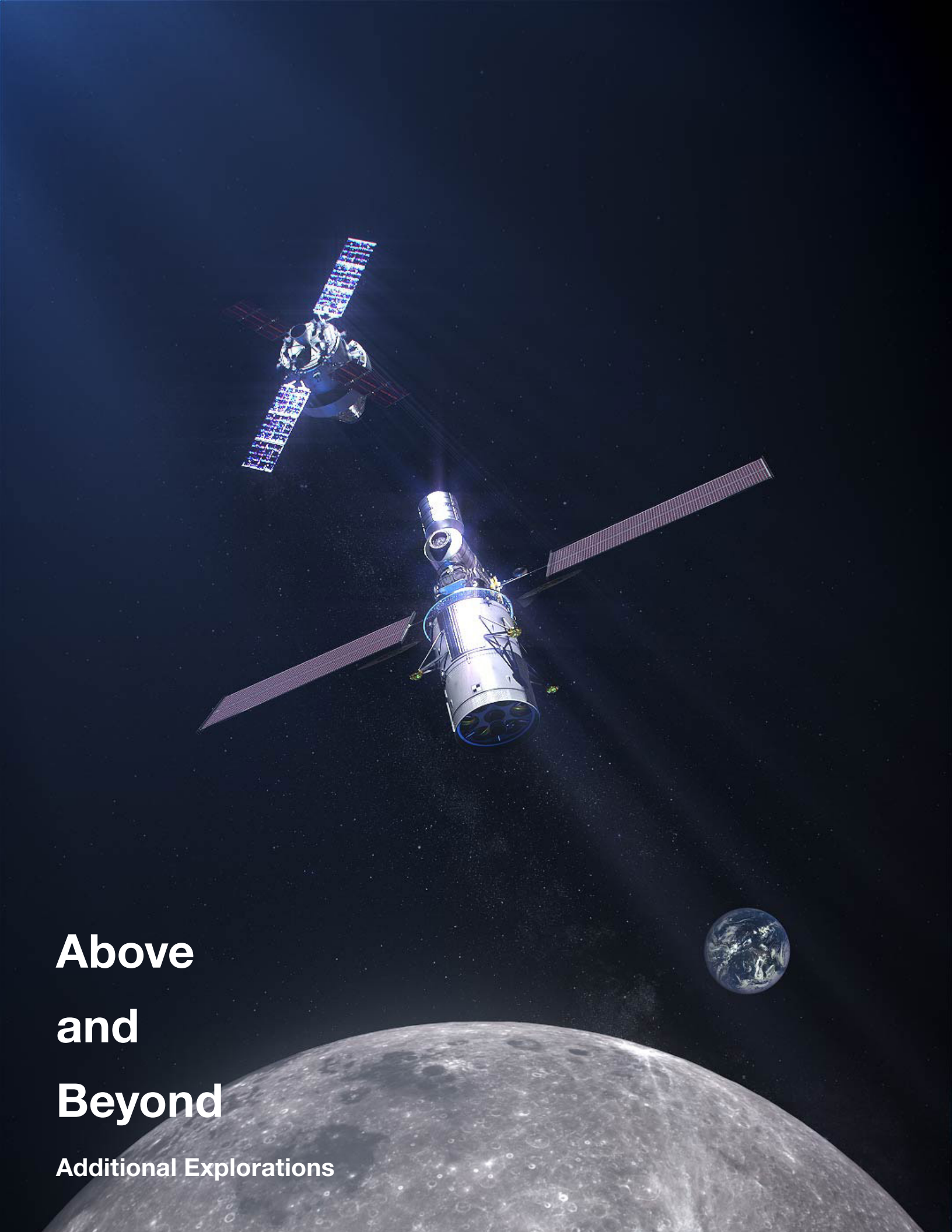

# Above and Beyond

Additional Explorations

## How High?

### Using Mathematics to Estimate Rocket Altitude

Students are excited to learn what altitude their rockets achieve. Altitude tracking is both simple and tricky. If the rocket goes straight up, it is pretty easy to get a good estimate of the altitude. The altitude tracker activity (page 81) provides a simple instrument and instructions for estimating rocket altitudes. A baseline is stretched out from the rocket launch site. The angle to the rocket, just before it starts its fall back to Earth, is measured.

The tangent of the angle is determined from the tangent table in the tracker activity. The tangent, multiplied by the length of the baseline, gives the altitude.

Single station tracking is easy to do. If you have two or more students measure the angle, averaging their estimates can increase accuracy.

### Single Station - No Wind

altitude (a) equals the tangent of the angle A times the baseline (b)

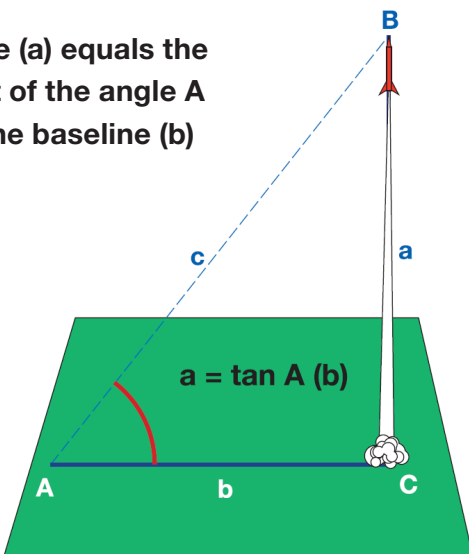

**Sample Measurement:**

**Angle A = 40 degrees**

**Tangent A = .8391**

**Baseline b = 25 m**

**a (altitude) = tan A x 25 m**

**a = 20.97 m**

Tracking becomes more challenging when rockets stray from straight up. Wind will cause the rocket to drift. Wind pushes the fins away while the nose cone points towards the wind. This causes the rocket to nose into the wind, resulting in larger altitude error estimates.

Angle Tangent		Angle Tangent	
0	.0000	46	1.036
1	.0175	47	1.072
2	.0349	48	1.111
3	.0524	49	1.150
4	.0699	50	1.192
5	.0875	51	1.235
6	.1051	52	1.280
7	.1228	53	1.327
8	.1405	54	1.376
9	.1584	55	1.428
10	.1763	56	1.483
11	.1944	57	1.540
12	.2126	58	1.600
13	.2309	59	1.664
14	.2493	60	1.732
15	.2679	61	1.804
16	.2867	62	1.881
17	.3057	63	1.963
18	.3249	64	2.050
19	.3443	65	2.145
20	.3640	66	2.246
21	.3839	67	2.356
22	.4040	68	2.475
23	.4245	69	2.605
24	.4452	70	2.747
25	.4663	71	2.904
26	.4877	72	3.078
27	.5095	73	3.271
28	.5317	74	3.487
29	.5543	75	3.732
30	.5774	76	4.011
31	.6009	77	4.331
32	.6249	78	4.705
33	.6494	79	5.145
34	.6745	80	5.671
35	.7002	81	6.314
36	.7265	82	7.115
37	.7536	83	8.144
38	.7813	84	9.514
39	.8098	85	11.43
40	.8391	86	14.30
41	.8693	87	19.08
42	.9004	88	28.64
43	.9325	89	57.29
44	.9657	90	---
45	1.000	---	---

One method for reducing windy day error is to set up the baseline perpendicular to the wind direction. In the diagram, wind causes the rocket to drift to the right. This stretches the baseline a bit, but the overall error for the altitude is reduced. Challenge advanced students to come up with a way of determining how much the baseline changes when the rocket drifts to the right.

Wind effects can also be addressed by employing two tracking stations at opposite ends of the baseline. The baseline is stretched up and down-wind. Each station measures the altitude the rocket achieves. Both stations calculate the altitude (one result will be higher than the actual altitude and the other lower) and divide by two.

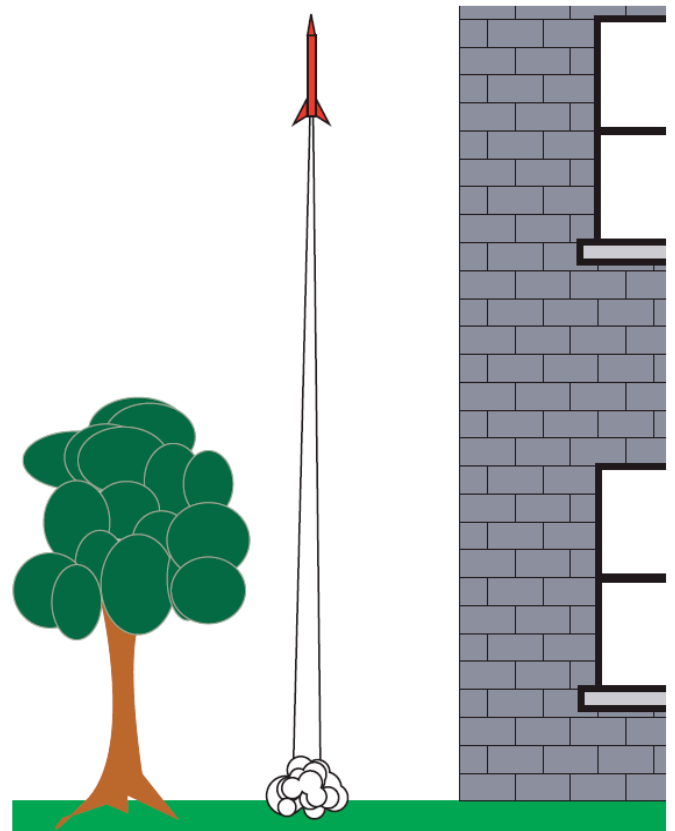
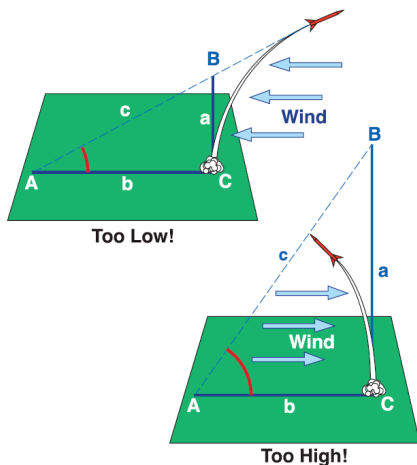

The above picture shows a different method for estimating altitude that is appropriate for lower grade students launching rockets that don't travel very high (e.g., straw rockets). Tracking students simply stand back and compare the rocket altitude to a building, tree, flagpole, etc.

### Single Station - Tracking with Wind

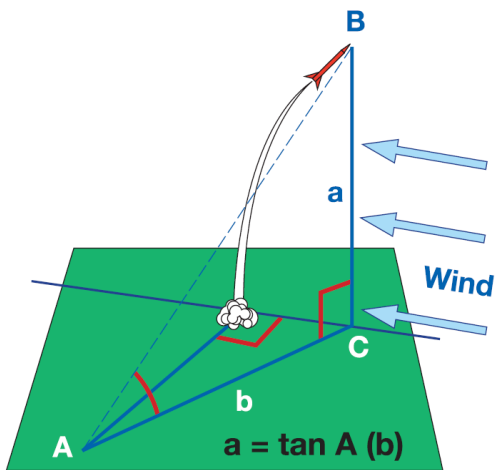

Angle A is reduced, but line b is increased by the drift of the rocket.

A rough estimate of rocket altitude can also be made with a stopwatch. Time the total flight of the rocket and divide the time by 2. This yields the approximate time it took for the rocket to fall from its highest point back to the ground. The equation for falling bodies yields the altitude estimate. This method won't work if the rocket has a recovery system such as streamers or parachutes to slow its fall.

**Sample Measurement:**

**Total flight time: 6.2 seconds**  
**Falling time/2 = 3.1 seconds**

$$h = \frac{1}{2} g t^2$$

$$h = \frac{1}{2} \times 9.8 \text{ m} \times 9.6 \text{ (the seconds cancel out)}$$

$$h = 47.04 \text{ m}$$

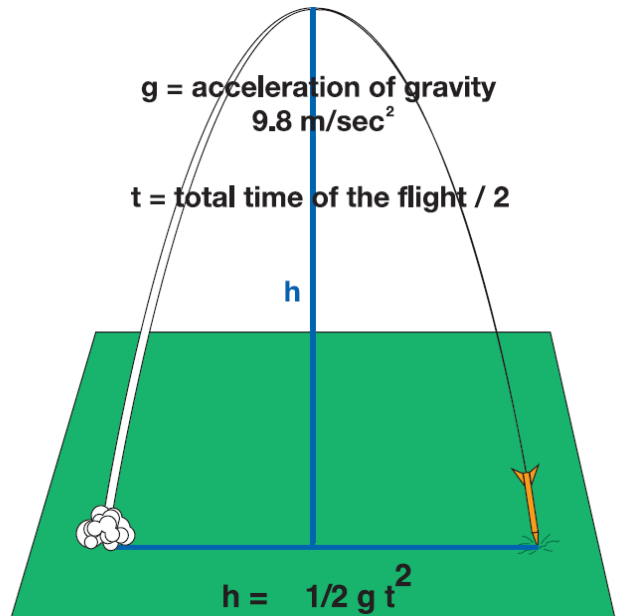

**Provides a rough estimate of the altitude reached. Air drag on the rocket is a significant source of error.**

There is a considerably more advanced method for altitude tracking that also involves two tracking stations. The method not only requires measuring the altitude angle of the rocket but also its azimuth, or compass direction, from the tracking site. These two measurements from each station provide very accurate estimates of altitude regardless of how much the rocket drifts from the vertical. The problem with the method is that it requires a tracking device similar to a surveyor transit plus experienced trackers to take the measurements. Rocket hobbyists, especially those that participate in high performance rocketry, use small recording altimeters inside their rocket payload sections. These rockets are easily capable of flights of several thousand meters, and ground tracking stations have a hard time providing consistent and accurate data. Upon recovery, the altimeters are read. For more information on two-station tracking and altimeters, search the Internet for "rocket altitude tracking."

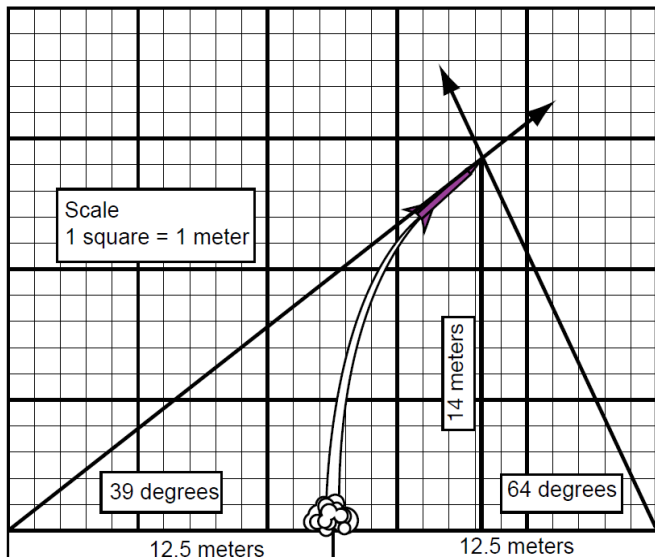

Here is a method for calculating altitude graphically. Two tracking stations are placed equidistant from the launcher. In this example, the stations are each 12.5 m from the launcher. Both stations measure the angle. On a piece of graph paper, a scale drawing of the stations and the launch site is made. Using the principle of similar triangles, the scale altitude of the rocket is measured - 14 m.

## Science Fiction and the Exploration of Space

Long before the first astronauts entered space, humans dreamed of space travel. Little about the space environment was known, and it seemed reasonable that the worlds above would be like the world below. In imagination, existing forms of transportation were sufficient to travel through the heavens. Storytellers, the first science fiction writers, concocted adventures that carried people to the Moon on sailing ships and platforms suspended beneath eagles flying to catch legs of mutton dangled just out of reach by sticks. Giant spring-propelled sleighs and whirlwinds transported others. In one story, people traveled to the Moon on the temporary bridge created by Earth's shadow during a lunar eclipse.

During the nineteenth and twentieth centuries, fictional space explorers began to travel through space using rockets, cannons, and antigravity substances. In 1865, Jules Verne's story, *De la terre à la lune*, space explorers traveled to the Moon inside a cannon shell. In 1901, an H.G. Wells story propelled a spacecraft to the Moon with an antigravity substance called "cavorite" in *The First Men in the Moon*.

Near the end of the nineteenth century, motion pictures were invented. Space exploration science fiction (sci-fi) stories quickly moved to the silver screen. Sci-fi became one of the first movie genres. In 1902, the 8-minute *Le Voyage dans la lune* was released. Loosely based on Jules Verne's story, the movie startled audiences with its special effects.



Special effects scene from *Le Voyage dans la lune*.

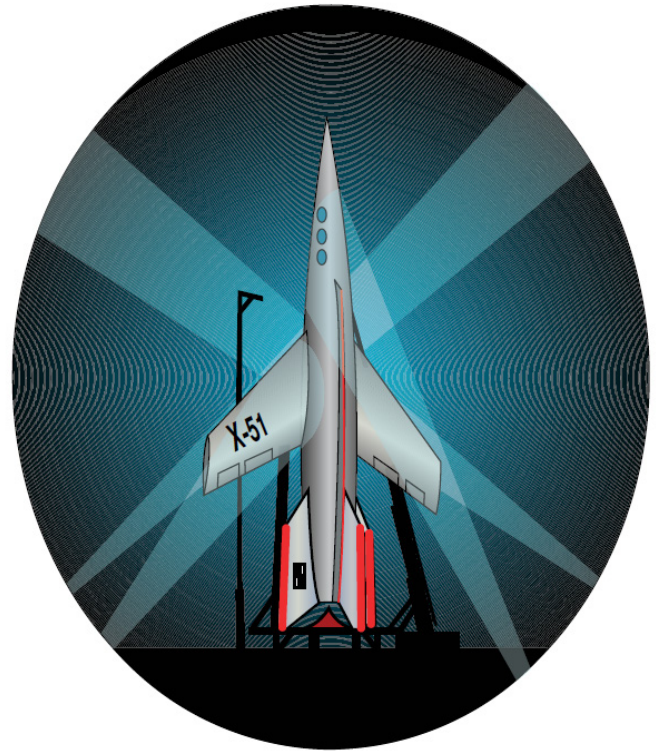

Another early effort was Fritz Lang's 1929 movie *Fra im Mond*. It featured a Moon rocket launched from underwater.

Since the earliest film efforts, hundreds of space exploration sci-fi movies and weekly "cliff-hanger" serials have been created. They tell fantastic stories and stretch the viewer's imagination from Earth orbit to the deepest reaches of outer space. In the late 1940s, movies were joined by television and began broadcasting multi-episode space "westerns."

Today, space exploration sci-fi is among the most popular of film and television genres. Audiences love the stories, in part because they make almost anything seem possible. The stories they tell are often visionary. Long before the Apollo program, movies took humans to the Moon and Mars. Long before they were needed, movie and television makers created spacesuits and space maneuvering units. Large space stations were erected in imaginary orbits. The first space stations didn't reach Earth orbit until the early 1970s, but they orbited Earth in 1950s films. Every few days a new extrasolar world is discovered by scientists. Science fiction space explorers have been exploring those worlds for decades.



However improbable and however dopey some of the early special effects may now seem, space exploration movies and television have much to offer.

Comparing the science and technology they present to real space exploration is a fascinating endeavor. What has turned out to be real and actually happened? What hasn't happened yet? What is scientifically correct? What is scientifically incorrect or just plain silly?

Regardless of their scientific and technological authenticity, space exploration movies and television energize the imagination. They have excited the masses and have helped generate popular support that makes real space exploration possible.

## Opportunities for Student Research

Space exploration sci-fi offers students interesting and entertaining research lines. Telling the difference between good and bad science and technology requires knowing good science and technology. Have students select a movie and review it for the science and technology presented. The following are a few questions students might try to answer in their reviews:

- What is the movie's title?
- When was the movie made?
- What is the plot (story) of the movie?
- How was space travel accomplished?
- Describe the vehicle used. What was its power source?
- Did the movie employ real science and technology? Give some examples.
- Did the movie make science and technology mistakes? Give some examples.
- Has NASA used similar science and technology to explore space? Explain.
- Did the movie accurately predict the future? Give some examples of how.

Here are a few suggested movies for students to review. All are available on DVDs from rental stores and online rental stores.



Scene from *Fra im Mond*.

### ***Rocketship XM (1950)***

Engine and fuel problems during flight cause Rocketship XM to zoom its crew past its original target, the Moon, and arrive at Mars instead. G forces and a destroyed Martian civilization are some of the challenges faced by the crew.

### ***Conquest of Space (1956)***

A space crew onboard a spinning wheel space station uses a space taxi during space walks to prepare their ship for launch. On its way to Mars, the crew dodges a flaming asteroid and deals with emotional problems.

### ***Forbidden Planet (1956)***

Humans travel by flying saucer to a distant world and meet their inner selves.

### ***First Men in the Moon (1964)***

An H. G. Wells story adaptation carries two accidental space travelers and an eccentric scientist to the Moon in an antigravity-propelled space sphere.

### ***2001 A Space Odyssey (1968), 2010 (1984)***

In a series of slow-moving visual experiences, humans travel to the Moon and Jupiter to follow mysterious alien signs. The film predicts space hotels and multi-year space missions.

### ***Star Wars, Episodes I - VII (1977 - 2005)***

Rebel forces battle an evil empire across a galaxy far, far away. A wide range of space vehicles, robots, and alien life sustain the action.

### ***Star Trek (1979 - 2002)***

In a series of movies Captains Kirk and Picard save Earth and strive for peace in the galaxy. Using warp drive and transporters, they boldly go where no humans have gone before.

## The Art of Spaceflight

Space art has long been a key part of the exploration of space. In the 1950s, space artists such as Chesley Bonestell illustrated space exploration concepts for books and magazine articles. At the same time, animation artists at Disney Studios, working with space experts such as Dr. Wernher von Braun, showed what the first missions to space, the Moon, and beyond might look like. The American public was enchanted by dreams of spaceflight, and the American effort to explore outer space was born.

Space art continues to support the exploration of space. Besides promoting mission concepts with decision makers and the public, space art also provides scientists, engineers, and technicians a concept picture of what they are trying to do. They see what the systems they are working on look like when assembled together. Furthermore, space art excites and motivates students to pursue careers in science, technology, engineering, and mathematics.

Early space art was created using traditional materials and techniques. Many space artists still portray their dreams this way, but computer graphics has also found a place in space art. Spacecraft can be created using 3D technology that permits them to be rotated, enlarged or reduced, and brought forward or backward and layered on one of many backgrounds.

The three pictures on the right show how forced perspective is accomplished. The top picture is a space art conception of the 1999 Terra Spacecraft launched on an Atlas II rocket. The middle picture shows the relationship between horizon line and the vanishing point. The bottom picture shows a sketch based on the original but with a few lines added to emphasize motion.

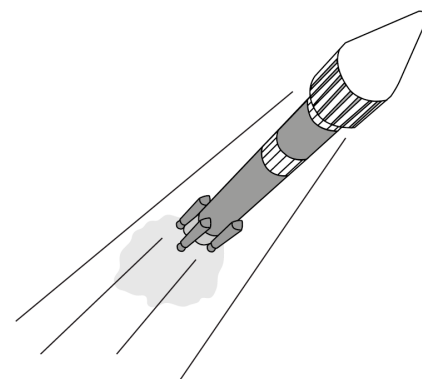
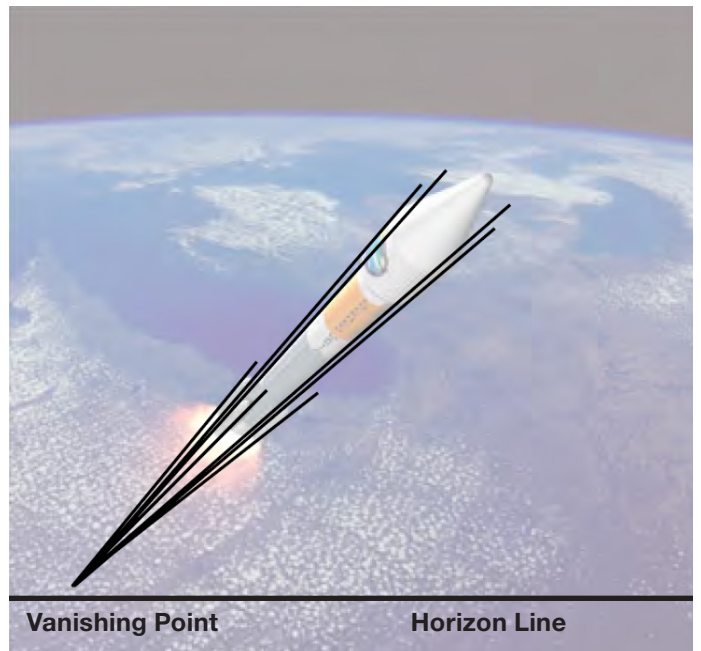

To create excitement, space artists often take advantage of forced perspective. For example, seeing a rocket launched from above provides a unique and exciting experience for the viewer. To create such a view, a horizon line and a vanishing point are laid out on the canvas or screen. Lines merging into the vanishing point provide guides for the 3D effect. Rockets, drawn within the lines, appear to go into or out of the picture.

Invite students to create their own space art. Space art begins with a mission. Students should first decide where they want their spacecraft to go. If the destination is Mars, what will the Mars spacecraft require for the mission? The length of time required to reach Mars will necessitate a larger vehicle than a vehicle for going to the Moon. More supplies and more crew will be needed, etc.

Space art is something that students of all ages can do. Young students can create an animated space launch with a simple paper fold trick.

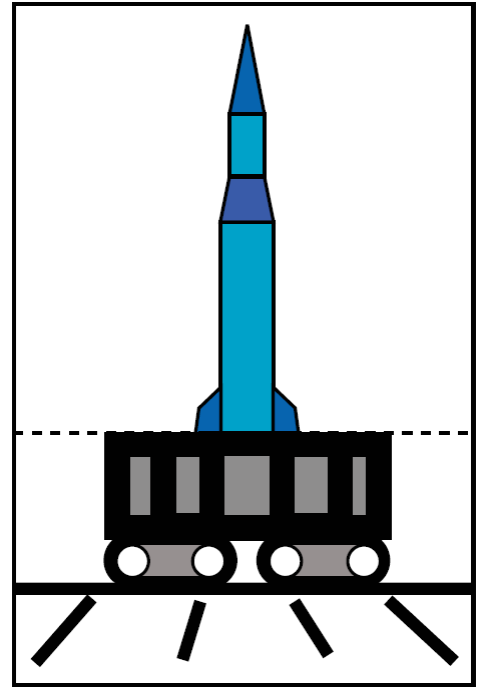

Fold the paper to prepare the rocket for launch.

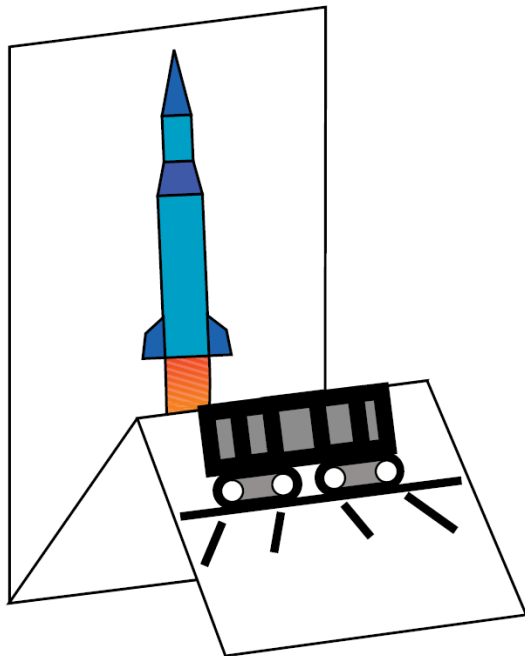

Make two folds in a strip of paper. Draw a launch platform on the lower segment. Draw a rocket launching on the upper two segments.

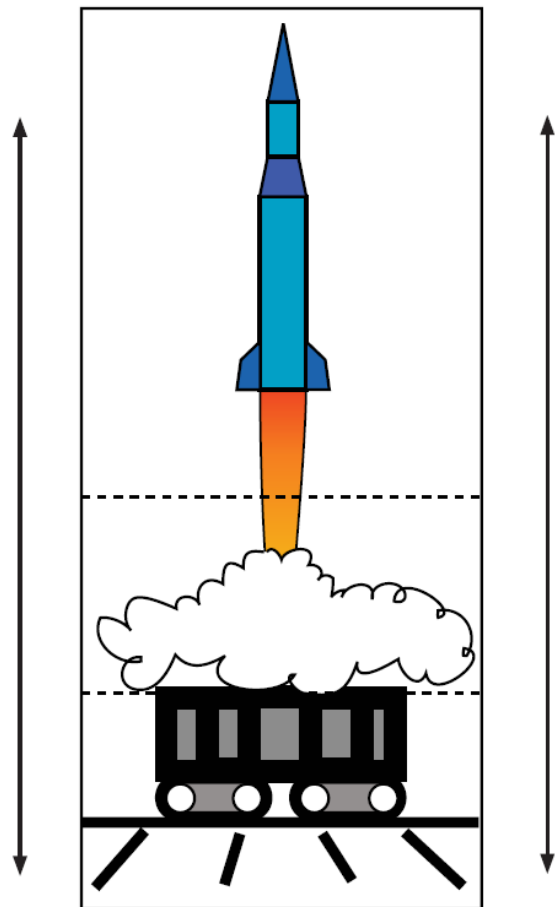

Pull on the top and bottom of the paper to open the folds and launch the rocket.

# Rocket Glossary

**Action** - A force (push or pull) acting on an object.

See Reaction.

**Altitude** - The height above Earth achieved by a rocket or other vehicle.

**Artemis Program** - NASA's new lunar exploration program, which includes sending the first woman and the next man to the Moon.

**Attitude Control Rockets** - Small rockets that are used as active controls to change the direction (attitude) a rocket is facing in space.

**Balanced Force** - A force that is counterbalanced by an opposing force, resulting in no change in motion.

**Canards** - Small movable fins located towards the nose cone of a rocket.

**Case** - The body of a solid propellant rocket that holds the propellant.

**Center of Mass** - The point in an object about which the object's mass is centered.

**Center of Pressure** - The point on the surface of an object about which the object's surface area is centered.

**Combustion Chamber** - A cavity inside a rocket where propellants burn.

**Compressed** - Material that is forced into a smaller space than normal.

**Drag** - Friction forces in the atmosphere that "drag" on a rocket to slow its flight.

**Exploration Ground Systems (EGS)** - NASA's program to develop and operate the systems and facilities necessary to process and launch rockets and spacecraft.

**Fins** - Arrow-like wings at the lower end of a rocket that stabilize the rocket in flight.

**Gimbaled Nozzles** - Tiltable rocket nozzles used for active flight control.

**Igniter** - A device that ignites a rocket's engines.

**Liquid Propellant** - Rocket propellants in liquid form.

**Mass** - The amount of matter contained in an object.

**Mass Fraction** - The mass of propellants in a rocket divided by the rocket's total mass.

**Microgravity** - An environment that imparts to an object a net acceleration that is small compared to what is produced by Earth at its surface.

**Motion** - Movement of an object in relation to its surroundings.

**Movable Fins** - Rocket fins that can move to stabilize a rocket's flight.

**Newton's Laws of Motion** - Laws governing all motion and in particular rocket flight.

**Nose Cone** - The cone-shaped front end of a rocket.

**Nozzle** - A bell-shaped opening at the lower end of a rocket engine through which a stream of hot gases is directed.

**Orion** - NASA's new spacecraft to carry humans on deep space missions.

**Oxidizer** - A chemical containing oxygen compounds that permit rocket fuel to burn in the atmosphere and space.

**Passive Controls** - Stationary devices, such as fixed fins, that stabilize a rocket in flight.

**Payload** - The cargo carried by a rocket.

**Propellant** - A mixture of fuel and oxidizer that burns to produce rocket thrust.

**Reaction** - A movement in the opposite direction from the imposition of an action. See Action.

**Rest** - The absence of movement of an object in relation to its surroundings.

**Solid Propellant** - Rocket fuel and oxidizer in solid form.

**Space Launch System (SLS)** - NASA's new super heavy-lift launch vehicle.

**Space Station** - An Earth orbiting space laboratory and testing ground for technologies needed for missions into the solar system.

**Stability** - A measure of the smoothness of the flight of the rocket.

**Stages** - Two or more rockets stacked on top of each other in order to reach a higher altitude or have a greater payload capacity.

**Throat** - The narrow opening of a rocket nozzle.

**Thrust** - The force from a rocket engine that propels it.

**Unbalanced Force** - A force that is not countered by another force in the opposite direction.

## **NASA Resources**

The National Aeronautics and Space Administration (NASA) has an amazing collection of resources for the classroom. Educator guides, fact sheets, activity booklets, and lithographs, just to name a few, have been developed and are free to download. Photo galleries, a video database, and a YouTube channel are also available. Information about programs, projects, and current & future missions can be found on NASA's portal. To speed you and your students on your way to your space exploration adventure, a few useful links are highlighted below.

**NASA Portal** – [www.nasa.gov](http://www.nasa.gov)

**Artemis Program** – [www.nasa.gov/specials/artemis/](http://www.nasa.gov/specials/artemis/)

**Space Launch System** – [www.nasa.gov/sls](http://www.nasa.gov/sls)

**Orion** – [www.nasa.gov/orion](http://www.nasa.gov/orion)

**Exploration Ground Systems** – [www.nasa.gov/egs](http://www.nasa.gov/egs)

**STEM Engagement** – [www.nasa.gov/stem](http://www.nasa.gov/stem)

**Social Media** – [www.nasa.gov/socialmedia](http://www.nasa.gov/socialmedia)

**Image Galleries** – [www.nasa.gov/multimedia/imagegallery/index.html](http://www.nasa.gov/multimedia/imagegallery/index.html)

**Videos** – [www.nasa.gov/multimedia/videogallery/index.html](http://www.nasa.gov/multimedia/videogallery/index.html)

**YouTube Channel** – [www.youtube.com/user/NASAtlevision](http://www.youtube.com/user/NASAtlevision)

**NASA Centers** – [www.nasa.gov/about/sites/index.html](http://www.nasa.gov/about/sites/index.html)

**History** – [www.nasa.gov/topics/history/index.html](http://www.nasa.gov/topics/history/index.html)